

SKN 100

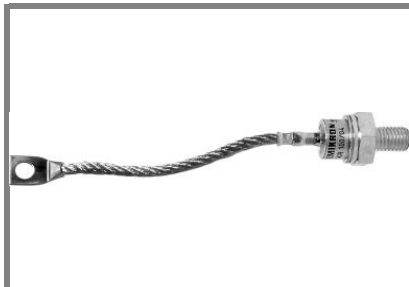

Stud Diode

Rectifier Diode

SKN 100
SKR 100

Features

- Reverse voltages up to 1800 V
- Hermetic metal case with glass insulator
- Threaded stud ISO M12, M16 x 1,5
- SKN: anode to stud, SKR: cathode to stud

Typical Applications*

- All-purpose mean power rectifier diodes
- Cooling via heatsinks
- Non-controllable and half-controllable rectifier
- Free-wheeling diodes
- Recommended snubber network:
RC: 0,25 μ F, 50 Ω , ($P_R = 2$ W),
 $R_P = 50$ k Ω ($P_R = 20$ W)

V_{RSM} V	V_{RRM} V	$I_{FRMS} = 200$ A (maximum value for continuous operation) $I_{FAV} = 100$ A (sin. 180; $T_c = 120$ °C)	
400	400	SKN 100/04	SKR 100/04
800	800	SKN 100/08	SKR 100/08
1200	1200	SKN 100/12	SKR 100/12
1400	1400	SKN 100/14	SKR 100/14
1600	1600	SKN 100/16	SKR 100/16
1800	1800	SKN 100/18	SKR 100/18

Symbol	Conditions	Values	Units
I_{FAV}	sin. 180; $T_c = 100$ °C	125	A
I_D	K 1,1; $T_a = 45$ °C; B2 / B6	140 / 204	A
	K 1,1F; $T_a = 35$ °C; B2 / B6	240 / 336	A
I_{FSM}	$T_{vj} = 25$ °C; 10 ms	1750	A
	$T_{vj} = 180$ °C; 10 ms	1500	A
i^2t	$T_{vj} = 25$ °C; 8,3 ... 10 ms	15000	A ² s
	$T_{vj} = 180$ °C; 8,3 ... 10 ms	11500	A ² s
V_F	$T_{vj} = 25$ °C; $I_F = 400$ A	max. 1,55	V
$V_{(TO)}$	$T_{vj} = 180$ °C	max. 0,85	V
r_T	$T_{vj} = 180$ °C	max. 1,8	m Ω
I_{RD}	$T_{vj} = 180$ °C; $V_{RD} = V_{RRM}$	max. 15	mA
Q_{rr}	$T_{vj} = 160$ °C; $-di_c/dt = 10$ A/ μ s	100	μ C
$R_{th(j-c)}$		0,45	K/W
$R_{th(c-s)}$		0,08	K/W
T_{vj}		- 40 ... + 180	°C
T_{stg}		- 55 ... + 180	°C
V_{isol}		-	V~
M_s	to heatsink	10	Nm
a		5 * 9,81	m/s ²
m	approx.	90	g
Case		E 13	

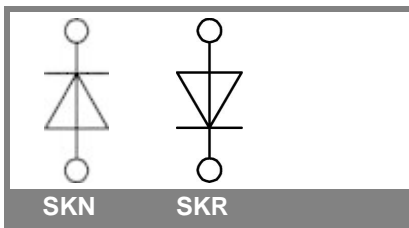

SKN

SKR

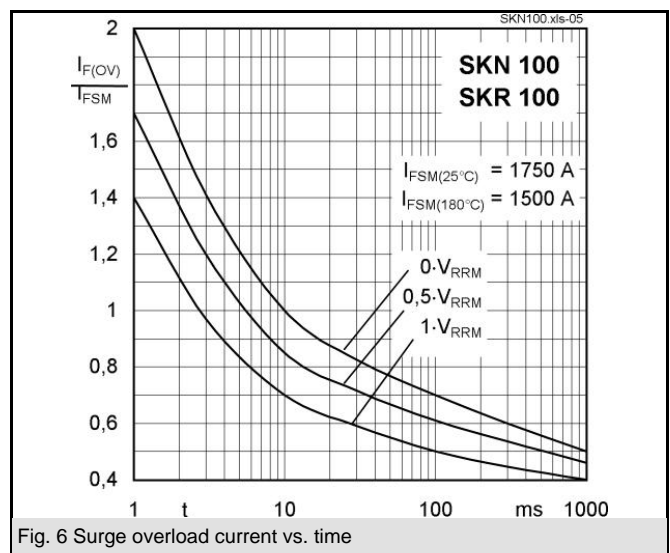
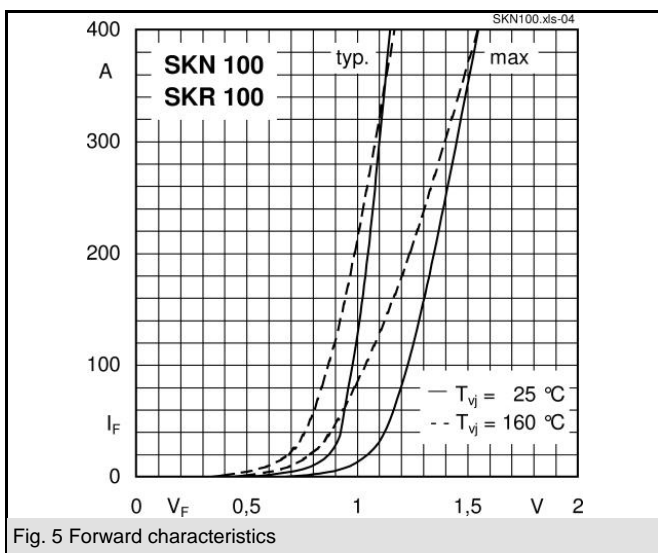
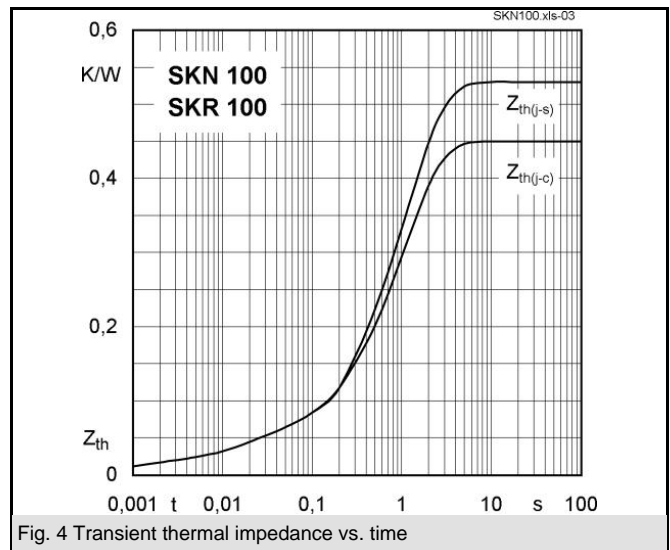
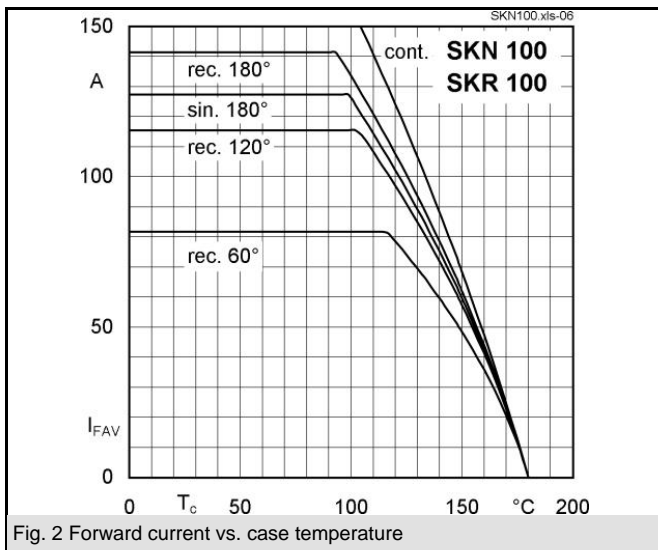
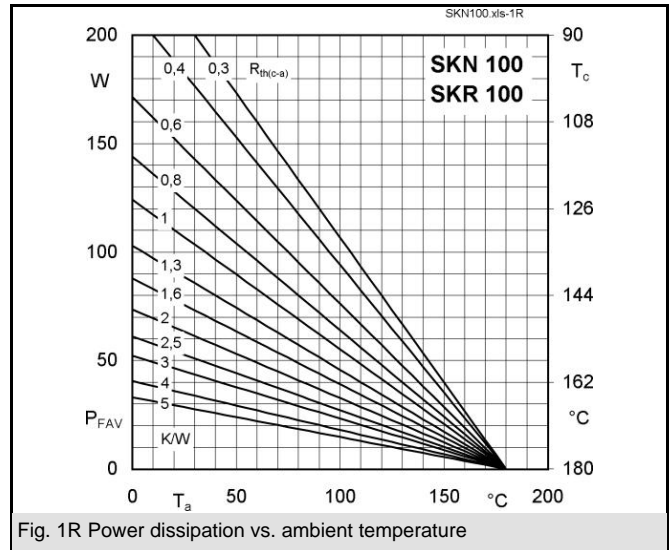
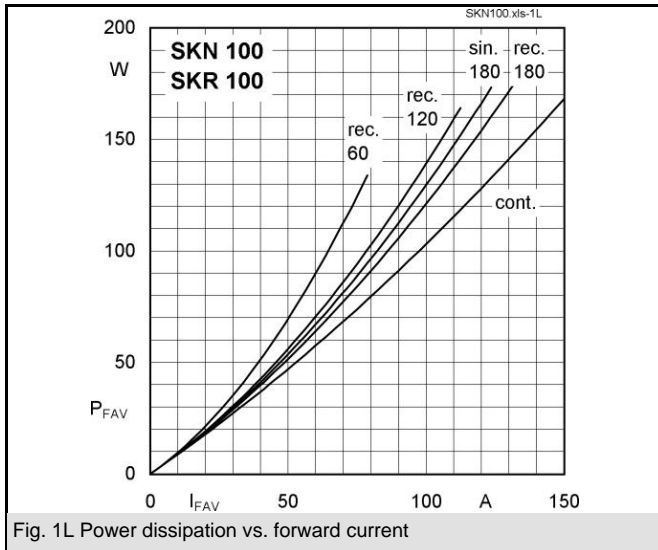

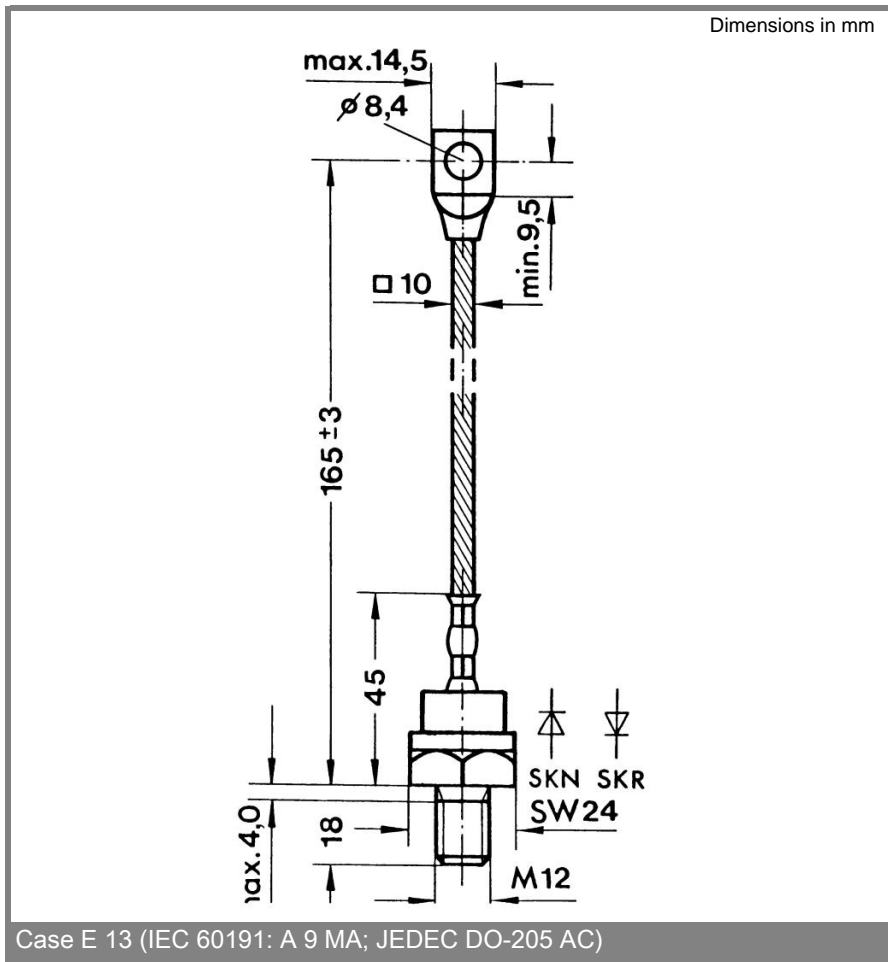

* The specifications of our components may not be considered as an assurance of component characteristics. Components have to be tested for the respective application. Adjustments may be necessary. The use of SEMIKRON products in life support appliances and systems is subject to prior specification and written approval by SEMIKRON. We therefore strongly recommend prior consultation of our personal.