



semi C3 Semiconductor, LLC

Applications

- Input Rectification
- Low Frequency Freewheel
- Battery Isolation

> Suitable for General Purpose Applications

> Isolated and Non-Isolated Tab

> V_R/V_{RRM} 400, 600, 800, 1000V

CRNA/CRNB25

25Amp - 400/600/800/1000V - RECTIFIER

2 Pin Package
(Standard)

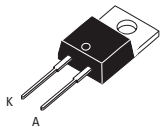

TO-220AB Isolated
(CRNA25)

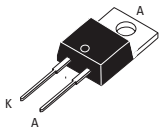

TO-220AB Non-Isolated
(CRNB25)

3 Pin Package
(Suffix L3)

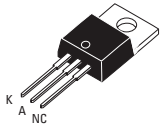

TO-220AB Isolated
(CRNA25...L3)

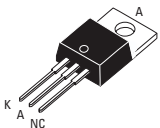

TO-220AB Non-Isolated
(CRNB25...L3)



ISO9001 Certified

Absolute Maximum Ratings

	CONDITIONS	SYMBOL	RATING
RMS On-State Current (full sine wave)	$T_c = 95^\circ\text{C}$ $T_c = 80^\circ\text{C}$ TO-220AB TO-220AB Iso	$I_{F(RMS)}$	25A
Average On-State Current	$T_c = 95^\circ\text{C}$ $T_c = 80^\circ\text{C}$ TO-220AB TO-220AB Iso	$I_{F(AV)}$	15.9A
Non Repetitive Surge Peak On-State Current (Full Cycle, T_j Initial = 25°C)	F = 50 Hz F = 60 Hz	I_{FSM}	300A 350A
I^2t Value for fusing	$t_p = 10$ ms	I^2t	508A ² s
Storage Temperature Range		T_{stg}	-40 to $+150^\circ\text{C}$
Operating Junction Temperature Range		T_j	-40 to $+125^\circ\text{C}$
Isolation Voltage (CRNA Series only)		V_{ISO}	2500 V_{RMS}

Electrical Characteristics

V_{FM} @ 25A	$T_j = 25^\circ\text{C}$	1.1V
I_{RM} @ $V_R = V_{RRM}$	$T_j = 25^\circ\text{C}$	0.1mA
I_{RM} @ $V_R = V_{RRM}$	$T_j = 125^\circ\text{C}$	1.0mA

Thermal Resistances

	PACKAGE	SYMBOL	RATING
Junction to Case (AC)	TO-220AB	$R_{th(j-c)}$	1.6 $^\circ\text{C/W}$
Junction to Case (AC)	TO-220AB Isolated	$R_{th(j-c)}$	2.5 $^\circ\text{C/W}$
Junction to Ambient	TO-220AB	$R_{th(j-a)}$	60 $^\circ\text{C/W}$
Junction to Ambient	TO-220AB Isolated	$R_{th(j-a)}$	60 $^\circ\text{C/W}$

GENERAL NOTES

1. All parameters at 25 degrees C unless otherwise specified.

Part Number Designation

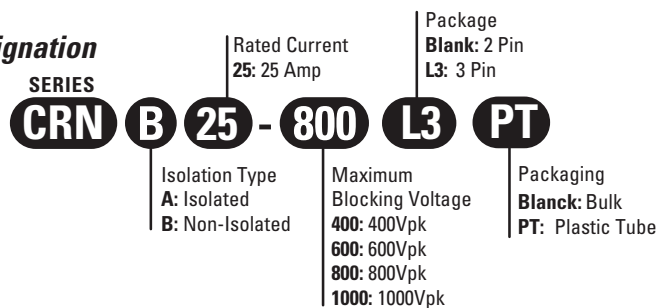



C3 Semiconductor, LLC

Dimensions 2 Pin Package

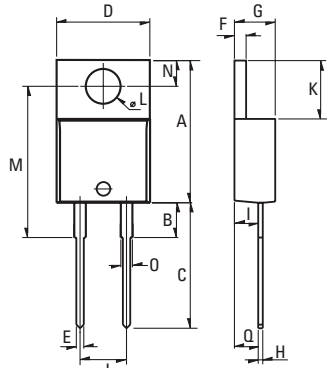

Weight: 2.3g (0.08 oz)

REF.	Millimeters			Inches		
	Min.	Typ.	Max.	Min.	Typ.	Max.
A	15.24		15.75	0.6		0.62
B		3.23			0.127	
C	12.78		13.79	0.503		0.543
D	9.96		10.36	0.392		0.408
E	0.69		0.94	0.027		0.037
F	1.22		1.32	0.048		0.052
G	4.62		4.83	0.182		0.19
H	0.46		0.61	0.018		0.024
I	2.49		2.84	0.098		0.112
J	2.39		2.69	0.094		0.106
K	6.48		6.88	0.255		0.271
L	3.78		3.89	0.149		0.153
M	15.49	16	16.51	0.61	0.63	0.65
N	2.59		2.9	0.102		0.114
O	0.99		1.55	0.039		0.061
Q		2.67			0.105	

CRNA/CRNB25

25Amp - 400/600/800/1000V - RECTIFIER

Characteristics

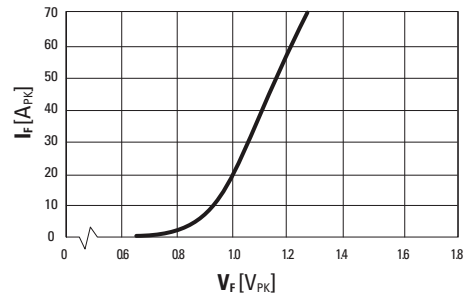

Fig. 1: On-state current versus on-state voltage (instantaneous values)

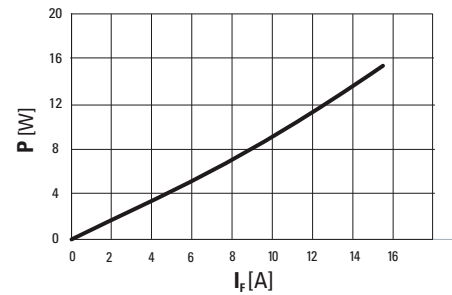

Fig. 3: Power dissipation versus average on-state current

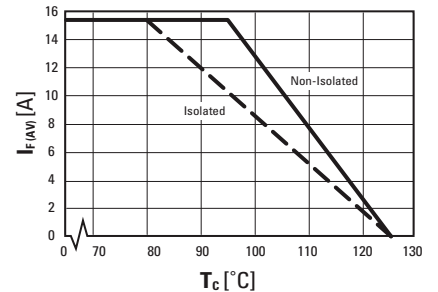

Fig. 2: Average on-state current versus case temperature

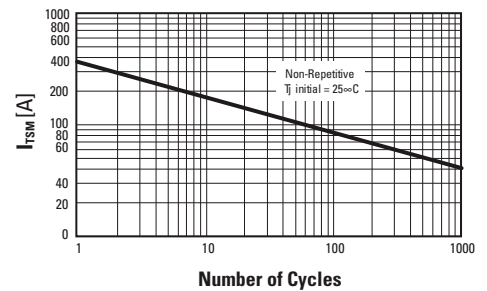
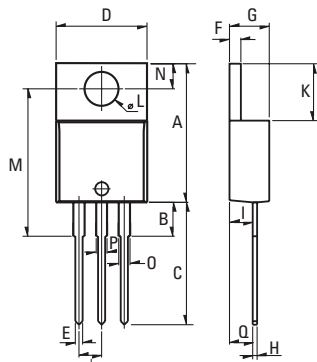

Fig. 4: Non-repetitive surge peak on-state current versus number of cycles.

Dimensions

 3 Pin Package

Weight: 2.3g (0.08 oz)

REF.	Millimeters			Inches		
	Min.	Typ.	Max.	Min.	Typ.	Max.
A	15.24		15.75	0.6		0.62
B		3.23			0.127	
C	12.78		13.79	0.503		0.543
D	9.96		10.36	0.392		0.408
E	0.69		0.94	0.027		0.037
F	1.22		1.32	0.048		0.052
G	4.62		4.83	0.182		0.19
H	0.46		0.61	0.018		0.024
I	2.49		2.84	0.098		0.112
J	2.39		2.69	0.094		0.106
K	6.48		6.88	0.255		0.271
L	3.78		3.89	0.149		0.153
M	15.49	16	16.51	0.61	0.63	0.65
N	2.59		2.9	0.102		0.114
O	0.99		1.55	0.039		0.061
P	0.99		1.55	0.039		0.061
Q		2.67			0.105	

ISO9001 Certified

© 2007 C3 Semiconductors, Specifications subject to change without notice.

Approvals

UL Recognized Component - E72445

(For CRNA series)

For recommended applications and more information contact:

USA: Sales Support (888) 882-8689

C3 Semiconductors, LLC. 2320 Paseo de las Americas, Ste. 104, San Diego, CA 92154

Email: sales@c3semi.com WEB SITE: http://www.C3semi.com