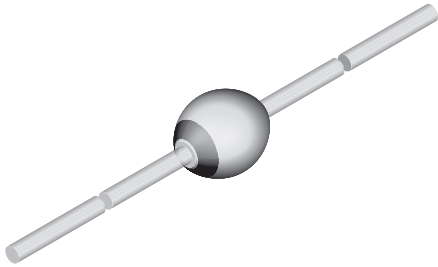


Fast Avalanche Sinterglass Diode



949539

FEATURES

- Glass passivated junction
- Hermetically sealed package
- Low reverse current
- Soft recovery characteristics
- Compliant to RoHS directive 2002/95/EC and in accordance to WEEE 2002/96/EC
- Halogen-free according to IEC 61249-2-21 definition



RoHS
COMPLIANT
HALOGEN
FREE

MECHANICAL DATA

Case: SOD-57

Terminals: plated axial leads, solderable per MIL-STD-750, method 2026

Polarity: color band denotes cathode end

Mounting position: any

Weight: approx. 369 mg

APPLICATIONS

- Fast “soft recovery” rectification diode

PARTS TABLE

PART	TYPE DIFFERENTIATION	PACKAGE
BYV37	$V_R = 800 \text{ V}; I_{FAV} = 2 \text{ A}$	SOD-57
BYV38	$V_R = 1000 \text{ V}; I_{FAV} = 2 \text{ A}$	SOD-57

ABSOLUTE MAXIMUM RATINGS ($T_{amb} = 25 \text{ }^\circ\text{C}$, unless otherwise specified)

PARAMETER	TEST CONDITION	PART	SYMBOL	VALUE	UNIT
Reverse voltage	See electrical characteristics	BYV37	$V_R = V_{RRM}$	800	V
		BYV38	$V_R = V_{RRM}$	1000	V
Peak forward surge current	$t_p = 10 \text{ ms}$, half sine wave		I_{FSM}	50	A
Average forward current			I_{FAV}	2	A
Non repetitive reverse avalanche energy	$I_{(BR)R} = 0.4 \text{ A}$		E_R	10	mJ
Junction and storage temperature range			$T_J = T_{stg}$	- 55 to + 175	$^\circ\text{C}$

MAXIMUM THERMAL RESISTANCE ($T_{amb} = 25 \text{ }^\circ\text{C}$, unless otherwise specified)

PARAMETER	TEST CONDITION	SYMBOL	VALUE	UNIT
Junction ambient	Lead length $l = 10 \text{ mm}$, $T_L = \text{constant}$	R_{thJA}	45	K/W
	On PC board with spacing 25 mm	R_{thJA}	100	K/W

ELECTRICAL CHARACTERISTICS ($T_{amb} = 25 \text{ }^\circ\text{C}$, unless otherwise specified)

PARAMETER	TEST CONDITION	PART	SYMBOL	MIN.	TYP.	MAX.	UNIT
Forward voltage	$I_F = 1 \text{ A}$		V_F	-	1	1.1	V
Reverse current	$V_R = V_{RRM}$		I_R	-	-	5	μA
	$V_R = V_{RRM}$, $T_J = 150 \text{ }^\circ\text{C}$		I_R	-	-	150	μA
Reverse recovery time	$I_F = 0.5 \text{ A}$, $I_R = 1 \text{ A}$, $i_R = 0.25 \text{ A}$		t_{rr}	-	-	300	ns
Diode capacitance	$V_R = 4 \text{ V}$, $f = 1 \text{ MHz}$		C_D	-	15	-	pF

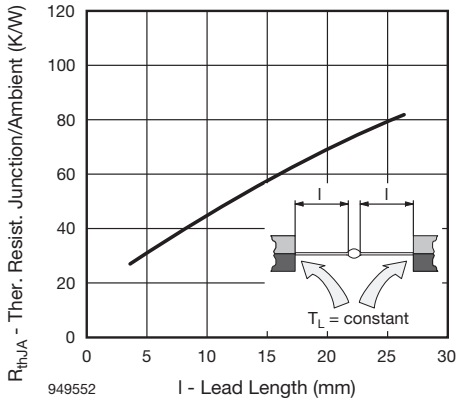
TYPICAL CHARACTERISTICS ($T_{amb} = 25\text{ }^{\circ}\text{C}$, unless otherwise specified)


Fig. 1 - Max. Thermal Resistance vs. Lead Length

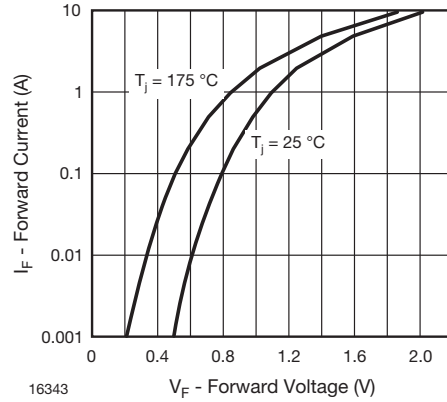


Fig. 4 - Forward Current vs. Forward Voltage

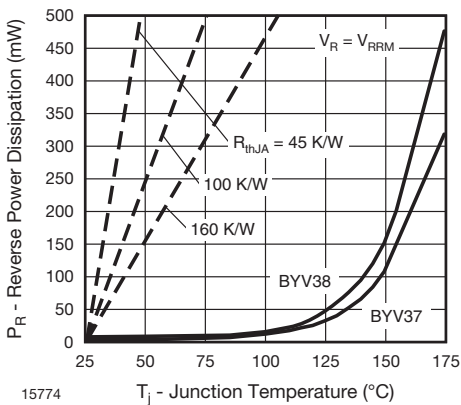


Fig. 2 - Max. Reverse Power Dissipation vs. Junction Temperature

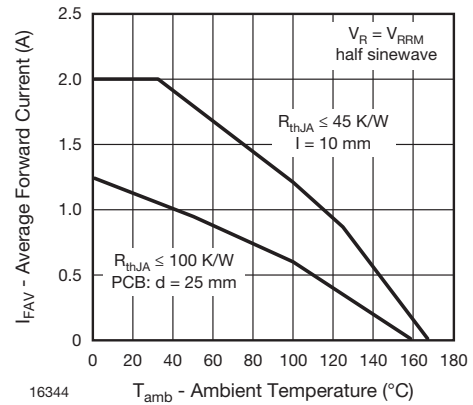


Fig. 5 - Max. Average Forward Current vs. Ambient Temperature

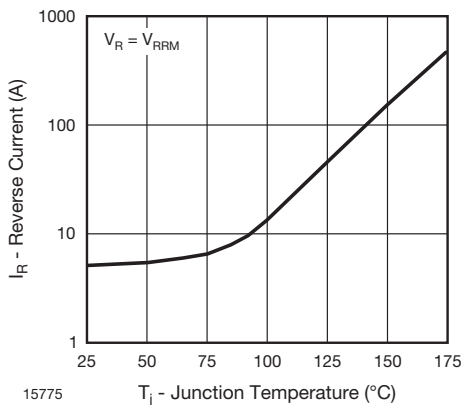


Fig. 3 - Max. Reverse Current vs. Junction Temperature

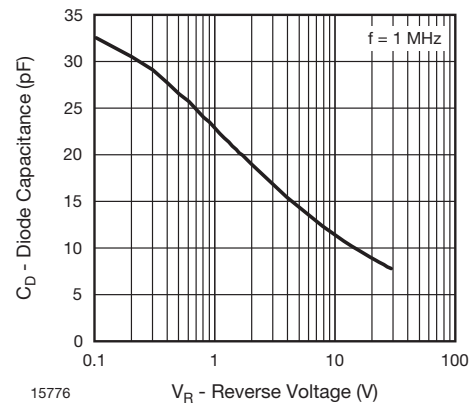


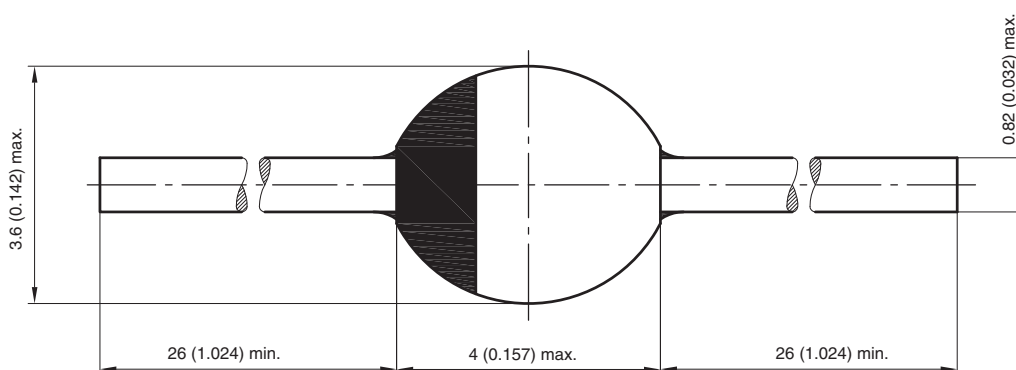
Fig. 6 - Typ. Diode Capacitance vs. Reverse Voltage

BYV37, BYV38

Vishay Semiconductors Fast Avalanche Sinterglass Diode



PACKAGE DIMENSIONS in millimeters (inches): SOD-57



20543
Rev. 3 - Date: 09.February 2005
Document no.:6.563-5006.3-4



Disclaimer

ALL PRODUCT, PRODUCT SPECIFICATIONS AND DATA ARE SUBJECT TO CHANGE WITHOUT NOTICE TO IMPROVE RELIABILITY, FUNCTION OR DESIGN OR OTHERWISE.

Vishay Intertechnology, Inc., its affiliates, agents, and employees, and all persons acting on its or their behalf (collectively, "Vishay"), disclaim any and all liability for any errors, inaccuracies or incompleteness contained in any datasheet or in any other disclosure relating to any product.

Vishay makes no warranty, representation or guarantee regarding the suitability of the products for any particular purpose or the continuing production of any product. To the maximum extent permitted by applicable law, Vishay disclaims (i) any and all liability arising out of the application or use of any product, (ii) any and all liability, including without limitation special, consequential or incidental damages, and (iii) any and all implied warranties, including warranties of fitness for particular purpose, non-infringement and merchantability.

Statements regarding the suitability of products for certain types of applications are based on Vishay's knowledge of typical requirements that are often placed on Vishay products in generic applications. Such statements are not binding statements about the suitability of products for a particular application. It is the customer's responsibility to validate that a particular product with the properties described in the product specification is suitable for use in a particular application. Parameters provided in datasheets and/or specifications may vary in different applications and performance may vary over time. All operating parameters, including typical parameters, must be validated for each customer application by the customer's technical experts. Product specifications do not expand or otherwise modify Vishay's terms and conditions of purchase, including but not limited to the warranty expressed therein.

Except as expressly indicated in writing, Vishay products are not designed for use in medical, life-saving, or life-sustaining applications or for any other application in which the failure of the Vishay product could result in personal injury or death. Customers using or selling Vishay products not expressly indicated for use in such applications do so at their own risk and agree to fully indemnify and hold Vishay and its distributors harmless from and against any and all claims, liabilities, expenses and damages arising or resulting in connection with such use or sale, including attorneys fees, even if such claim alleges that Vishay or its distributor was negligent regarding the design or manufacture of the part. Please contact authorized Vishay personnel to obtain written terms and conditions regarding products designed for such applications.

No license, express or implied, by estoppel or otherwise, to any intellectual property rights is granted by this document or by any conduct of Vishay. Product names and markings noted herein may be trademarks of their respective owners.