

Typical Units

DATEL's new LSN D3 Series SIP's (single-in-line packages) are non-isolated DC/DC converters that accept a 3.3V input (3.0V to 3.6V input range) and deliver 1V, 1.2V, 1.25V, 1.5V, 1.8V, 2V or 2.5V outputs at 10 Amps. LSN D3 SIP's are designed to take on-board 3.3V power and convert it, with the highest efficiency in the smallest space, to any lower voltage required by today's current-hungry DSP's, ASIC's and CPLD's.

## Features

- Industry-standard SIP pinout
- Shorter (2.0" vs. 2.5") package length
- 3.0-3.6V input range
- 1/1.2/1.25/1.5/1.8/2/2.5V outputs @ 10A
- Non-isolated, fully synchronous, 300kHz, buck topology
- Outstanding performance:
  - ±1% setpoint accuracy
  - Efficiencies to 94% @ 10 Amps
  - Noise as low as 10mVp-p
  - Stable no-load operation
  - Trimmable output voltage
- Remote on/off and sense pins
- Thermal Shutdown
- No derating to +71°C, natural convection
- UL/IEC/EN60950 certified
- EMC compliant

The miniature size of LSN D3's makes them ideal for true point-of-use power processing. Vertical-mount packages occupy a mere 0.7 square inches (440 sq. mm), and they are available in industry-standard and Tyco-compatible pinout. Horizontal-mount packages ("H" suffix) are only 0.34 inches (8.6mm) high.

The LSN's best-in-class power density is achieved with a fully synchronous, fixed-frequency (300kHz), buck topology that also delivers: high efficiency (94% for 2.5V<sub>out</sub> models), low noise (10mVp-p typ.), tight line/load regulation ( $\pm 0.1\% \pm 0.25\%$  max.), quick step response (100µsec), stable no-load operation, and no output reverse conduction.

The fully functional LSN's feature output overcurrent detection, continuous short-circuit protection, an output-voltage trim function, a remote on/off control pin (pull high to disable), thermal shutdown, and a sense pin. High efficiency enables the LSN D3's to deliver rated output currents of 10 Amps at ambient temperatures to +71°C with no air flow (natural convection).

If your low-voltage, high-current requirements have made the use of inefficient linear regulators impractical, take a look at one of DATEL's easy-to-use, low-cost LSN SIP's. All devices are UL/IEC/EN60950 certified and EMC compliant. UL, CB, HALT and EMC reports are available upon request.

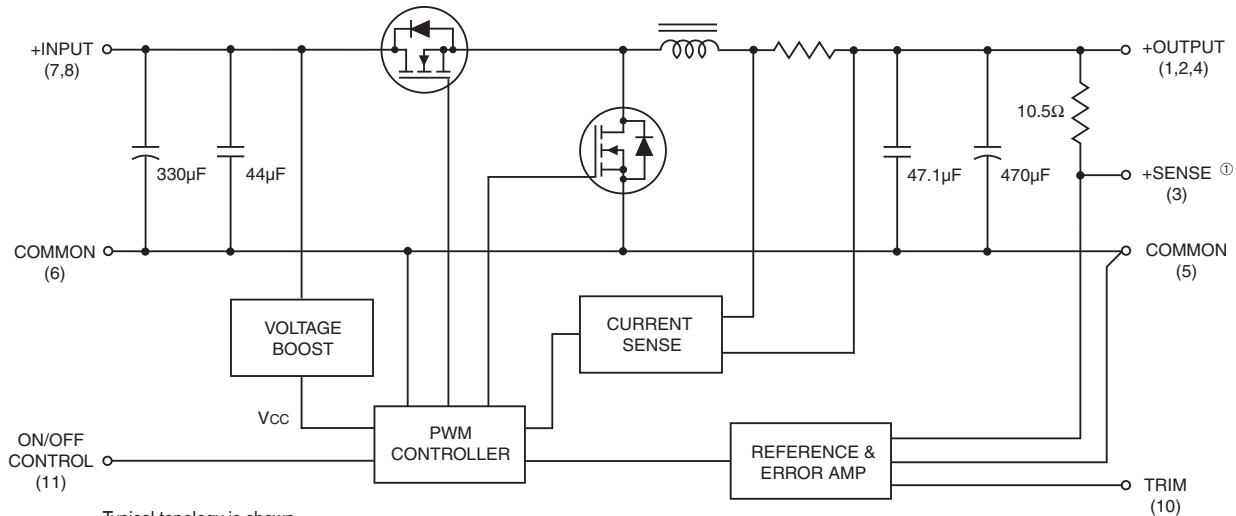

Typical topology is shown

Figure 1. Simplified Schematic

① For devices with the sense-pin removed ("B" suffix), the feedback path is through the +Output pin and not the +Sense pin.



## Performance Specifications and Ordering Guide ①

Root Model ⑤	Output						Input			Efficiency			Package (Case, Pinout)
	V <sub>OUT</sub> (Volts)	I <sub>OUT</sub> (Amps)	R/N (mVp-p) ②		Regulation (Max.) ③		V <sub>IN</sub> Nom. (Volts)	Range (Volts)	I <sub>IN</sub> ④ (mA/A)	Full Load		½ Load	
			Typ.	Max.	Line	Load				Min.	Typ.		
LSN-1/10-D3	1	10	10	35	±0.1%	±0.25%	3.3	3.0-3.6	70/3.73	83.5%	86.5%	90.5%	B7/B7x, P59
LSN-1.2/10-D3	1.2	10	10	35	±0.1%	±0.25%	3.3	3.0-3.6	70/4.42	85%	88%	91%	B7/B7x, P59
LSN-1.25/10-D3	1.25	10	10	35	±0.1%	±0.25%	3.3	3.0-3.6	60/4.30	85%	88%	91%	B7/B7x, P59
LSN-1.5/10-D3	1.5	10	10	35	±0.1%	±0.25%	3.3	3.0-3.6	70/5.47	87.5%	90%	92.2%	B7/B7x, P59
LSN-1.8/10-D3	1.8	10	10	35	±0.1%	±0.25%	3.3	3.0-3.6	70/6.33	89%	91.5%	93.5%	B7/B7x, P59
LSN-2/10-D3	2	10	10	35	±0.1%	±0.25%	3.3	3.0-3.6	70/6.96	89.5%	92.5%	94%	B7/B7x, P59
LSN-2.5/10-D3	2.5	10	10	35	±0.1%	±0.25%	3.3	3.0-3.6	70/8.50	91%	94%	95.5%	B7/B7x, P59

- ① Typical at T<sub>A</sub> = +25°C under nominal line voltage and full-load conditions, unless otherwise noted. All models are tested and specified with external 22µF input and output capacitors. These capacitors are necessary to accommodate our test equipment and may not be required to achieve specified performance in your applications. See I/O Filtering and Noise Reduction.
- ② Ripple/Noise (R/N) is tested/specified over a 20MHz bandwidth and may be reduced with external filtering. See I/O Filtering and Noise Reduction for details.

- ③ These devices have no minimum-load requirements and will regulate under no-load conditions. Regulation specifications describe the output-voltage deviation as the line voltage or load is varied from its nominal/midpoint value to either extreme.
- ④ Nominal line voltage, no-load/full-load conditions.
- ⑤ These are not complete model numbers. Please refer to the Part Number Structure for additional options when ordering.

### PART NUMBER STRUCTURE

**LSN-1.8/10-D3BHJ-C**

**Output Configuration:**  
L = Unipolar Low Voltage

**Non-Isolated SIP**

**Nominal Output Voltage:**  
1, 1.2, 1.25, 1.5, 1.8, 2, or 2.5 Volts

**Maximum Rated Output Current in Amps**

**Input Voltage Range:**  
D3 = 3 to 3.6 Volts (3.3V nominal)

**RoHS-6 compliant**

**J Suffix:**  
Reversed Pin Vertical Mount

**H Suffix:**  
Horizontal Mount

**B Suffix:**  
No Remote Sense (Pin 3 removed)

See page 12 for Part Number Structure and ordering details.

### MECHANICAL SPECIFICATIONS

**Case B7 Vertical Mounting (Standard)**

**Case B7B Reverse Pin Vertical Mounting (Tyco/Lineage-compatible)**

Dimensions are in inches (mm shown for ref. only).

**Case B7A Horizontal Mounting**

**Standard model pin lengths are shown.**

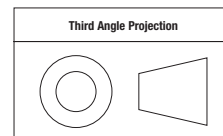

Tolerances (unless otherwise specified):  
 .XX ± 0.02 (0.5)  
 .XXX ± 0.010 (0.25)  
 Angles ± 2°

Components are shown for reference only.

I/O Connections					
Pin	Function P59*	Pin	Function P59*	Pin	Function P59*
1	+Output	5	Common	9	No Pin
2	+Output	6	Common	10	V <sub>OUT</sub> Trim
3	+Sense *	7	+Input	11	On/Off Control
4	+Output	8	+Input		

\* Pin 3 (+Sense) removed for "B" suffix models.

## Performance/Functional Specifications

 Typical @ T<sub>A</sub> = +25°C under nominal line voltage and full-load conditions unless noted. ①

Input	
<b>Input Voltage Range</b>	3.0 to 3.6 Volts (3.3V nominal)
<b>Input Current:</b>	
Normal Operating Conditions	See Ordering Guide
Inrush Transient	0.02A <sup>2</sup> sec
Standby/Off Mode	3mA
Output Short-Circuit Condition ②	70mA average
<b>Input Reflected Ripple Current ②</b>	50mAp-p
<b>Input Filter Type</b>	Capacitive (374µF)
<b>Overshoot Protection</b>	None
<b>Reverse-Polarity Protection</b>	None, install external fuse
<b>Undervoltage Shutdown</b>	None
<b>Sense Range</b>	10% of V <sub>OUT</sub>
<b>On/Off Control ② ③</b>	On = open (internal pulldown) Off = +2.8V to +V <sub>IN</sub> (<3mA)
Output	
<b>V<sub>OUT</sub> Accuracy (50% load)</b>	±1% maximum
<b>Minimum Loading ①</b>	No load
<b>Maximum Capacitive Load</b>	10,000µF (electrolytic)
<b>V<sub>OUT</sub> Trim Range ②</b>	±10%
<b>Ripple/Noise (20MHz BW) ① ② ④</b>	See Ordering Guide
<b>Temperature Coefficient</b>	±0.02%/°C
<b>Total Accuracy</b>	3% over line/load/temperature
<b>Efficiency ②</b>	See Ordering Guide
<b>Overcurrent Detection and Short-Circuit Protection: ②</b>	
Current-Limiting Detection Point	16 (12.5 to 22) Amps
Short-Circuit Detection Point	98% of V <sub>OUT</sub> set
SC Protection Technique	Hiccup with auto recovery
Short-Circuit Current	600mA average
Dynamic Characteristics	
<b>Transient Response (50% load step)</b>	100µsec to ±2% of final value
<b>Start-Up Time: ②</b>	
V <sub>IN</sub> to V <sub>OUT</sub>	7msec
On/Off to V <sub>OUT</sub>	6msec
<b>Switching Frequency</b>	300kHz (+40kHz, -50kHz)
Environmental	
<b>MTBF ⑤</b>	2.1 million hours
<b>Operating Temperature: (Ambient) ②</b>	-40 to +85°C with Derating See Derating Curves
<b>Thermal Shutdown</b>	+115°C
Physical	
<b>Dimensions</b>	See Mechanical Specifications
<b>Pin Dimensions/Material</b>	0.03" (0.76mm) round copper alloy with tin plate over nickel underplate
<b>Weight</b>	0.3 ounces (8.5g)
<b>Flamability Rating</b>	UL94V-0
<b>Safety</b>	UL/cUL/IEC/EN 60950-1, CSA-C22.2 No. 234

① All models are tested/specified with external 22µF input/output capacitors. These caps accommodate our test equipment and may not be required to achieve specified performance in your applications. All models are stable and regulate within spec under no-load conditions.

② See Technical Notes and Performance Curves for details.

③ The On/Off Control (pin 11) is designed to be driven with open-collector logic or the application of appropriate voltages (referenced to Common, pins 5 and 6).

④ Output noise may be further reduced with the installation of additional external output filtering. See I/O Filtering and Noise Reduction.

⑤ Calculated using the Telcordia (Bellcore) SR-332 Method 1, Case 3, ground fixed conditions, T<sub>A</sub> = +25°C, full load, natural convection, +55°C component temperature.

## Absolute Maximum Ratings

<b>Input Voltage:</b>	6 Volts
Continuous or transient	
<b>On/Off Control (Pin 11)</b>	+V <sub>IN</sub>
<b>Input Reverse-Polarity Protection</b>	None, install external fuse
<b>Output Overvoltage Protection</b>	None
<b>Output Current</b>	Current limited. Devices can withstand sustained output short circuits without damage.
<b>Storage Temperature</b>	-40 to +125°C
<b>Lead Temperature (soldering, 10 sec.)</b>	+300°C

These are stress ratings. Exposure of devices to greater than any of these conditions may adversely affect long-term reliability. Proper operation under conditions other than those listed in the Performance/Functional Specifications Table is not implied.

## TECHNICAL NOTES

### Return Current Paths

The LSN D3 SIP's are non-isolated DC/DC converters. Their two Common pins (pins 5 and 6) are connected to each other internally (see Figure 1). To the extent possible (with the intent of minimizing ground loops), input return current should be directed through pin 6 (also referred to as -Input or Input Return), and output return current should be directed through pin 5 (also referred to as -Output or Output Return). Any on/off control signals applied to pin 11 (On/Off Control) should be referenced to Common (specifically pin 6).

### I/O Filtering and Noise Reduction

All models in the LSN D3 Series are tested and specified with external 22µF input and output capacitors. These capacitors are necessary to accommodate our test equipment and may not be required to achieve desired performance in your application. The LSN D3's are designed with high-quality, high-performance *internal* I/O caps, and will operate within spec in most applications with *no additional external components*.

In particular, the LSN D3's input capacitors are specified for low ESR and are fully rated to handle the units' input ripple currents. Similarly, the internal output capacitors are specified for low ESR and full-range frequency response. As shown in the Performance Curves, removal of the external output caps has minimal effect on output noise.

In critical applications, input/output ripple/noise may be further reduced using filtering techniques, the simplest being the installation of external I/O caps.

External input capacitors serve primarily as energy-storage devices. They minimize high-frequency variations in input voltage (usually caused by IR drops in conductors leading to the DC/DC) as the switching converter draws pulses of current. Input capacitors should be selected for bulk capacitance (at appropriate frequencies), low ESR, and high rms-ripple-current ratings. The switching nature of modern DC/DC's requires that the dc input voltage source have low ac impedance at the frequencies of interest. Highly inductive source impedances can greatly affect system stability. Your specific system configuration may necessitate additional considerations.

Output ripple/noise (also referred to as periodic and random deviations or PARD) may be reduced below specified limits with the installation of additional external output capacitors. Output capacitors function as true filter

elements and should be selected for bulk capacitance, low ESR, and appropriate frequency response. Any scope measurements of PARD should be made directly at the DC/DC output pins with scope probe ground less than 0.5" in length.

All external capacitors should have appropriate voltage ratings and be located as close to the converters as possible. Temperature variations for all relevant parameters should be taken into consideration.

The most effective combination of external I/O capacitors will be a function of your line voltage and source impedance, as well as your particular load and layout conditions.

### Input Fusing

Most applications and or safety agencies require the installation of fuses at the inputs of power conversion components. LSN D3 Series DC/DC converters are not internally fused. Therefore, if input fusing is mandatory, either a normal-blow or a fast-blow fuse with a value no greater than 17 Amps should be installed within the ungrounded input path to the converter.

As a rule of thumb however, we recommend to use a fast-blow fuse with a typical value of about twice the maximum input current, calculated at low line with the converters minimum efficiency.

### Safety Considerations

LSN D3 SIP's are non-isolated DC/DC converters. In general, all DC/DC's must be installed, including considerations for I/O voltages and spacing/separation requirements, in compliance with relevant safety-agency specifications (usually UL/IEC/EN60950).

In particular, for a non-isolated converter's output voltage to meet SELV (safety extra low voltage) requirements, its input must be SELV compliant. If the output needs to be ELV (extra low voltage), the input must be ELV.

### Input Overvoltage and Reverse-Polarity Protection

LSN D3 SIP Series DC/DC's do not incorporate either input overvoltage or input reverse-polarity protection. Input voltages in excess of the specified absolute maximum ratings and input polarity reversals of longer than "instantaneous" duration can cause permanent damage to these devices.

### Start-Up Time

The V<sub>IN</sub> to V<sub>OUT</sub> Start-Up Time is the interval between the time at which a ramping input voltage crosses the lower limit of the specified input voltage range (3 Volts) and the fully loaded output voltage enters and remains within its specified accuracy band. Actual measured times will vary with input source impedance, external input capacitance, and the slew rate and final value of the input voltage as it appears to the converter.

The On/Off to V<sub>OUT</sub> Start-Up Time assumes the converter is turned off via the On/Off Control with the nominal input voltage already applied to the converter. The specification defines the interval between the time at which the converter is turned on and the fully loaded output voltage enters and remains within its specified accuracy band. See Typical Performance Curves.

### Remote Sense

LSN D3 SIP Series DC/DC converters offer an output sense function on pin 3. The sense function enables point-of-use regulation for overcoming moderate

IR drops in conductors and/or cabling. Since these are non-isolated devices whose inputs and outputs usually share the same ground plane, sense is provided only for the +Output.

The remote sense line is part of the feedback control loop regulating the DC/DC converter's output. The sense line carries very little current and consequently requires a minimal cross-sectional-area conductor. As such, it is not a low-impedance point and must be treated with care in layout and cabling. Sense lines should be run adjacent to signals (preferably ground), and in cable and/or discrete-wiring applications, twisted-pair or similar techniques should be used. To prevent high frequency voltage differences between V<sub>OUT</sub> and Sense, we recommend installation of a 1000pF capacitor close to the converter.

The sense function is capable of compensating for voltage drops between the +Output and +Sense pins that do not exceed 10% of V<sub>OUT</sub>.

$$[V_{OUT(+)} - \text{Common}] - [\text{Sense}(+) - \text{Common}] \leq 10\%V_{OUT}$$

Power derating (output current limiting) is based upon maximum output current and voltage at the converter's output pins. Use of trim and sense functions can cause the output voltage to increase, thereby increasing output power beyond the LSN's specified rating. Therefore:

$$(V_{OUT \text{ at pins}}) \times (I_{OUT}) \leq \text{rated output power}$$

The internal 10.5Ω resistor between +Sense and +Output (see Figure 1) serves to protect the sense function by limiting the output current flowing through the sense line if the main output is disconnected. It also prevents output voltage runaway if the sense connection is disconnected.

*Note: Connect the +Sense pin (pin 3) to +Output (pin 4) at the DC/DC converter pins, if the sense function is not used for remote regulation.*

### On/Off Control and Power-up Sequencing

The On/Off Control pin may be used for remote on/off operation. LSN D3 SIP Series DC/DC's are designed so they are enabled when the control pin is left open (internal pull-down to Common) and disabled when the control pin is pulled high (+2.8V to +V<sub>IN</sub>), as shown in Figure 2 and 2a.

Dynamic control of the on/off function is best accomplished with a mechanical relay or open-collector/open-drain drive circuit. The drive circuit should be able to sink appropriate current when activated and withstand appropriate voltage when deactivated.

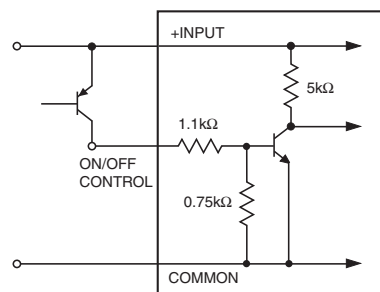
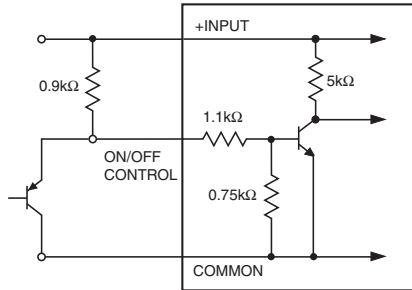

Figure 2. Driving the On/Off Control Pin with an Open-Collector Drive Circuit

The on/off control function, however, can be externally inverted so that the converter will be disabled while the input voltage is ramping up and then "released" once the input has stabilized.



**Figure 2a. Inverting On/Off Control Pin Signal and Power-Up Sequencing**

For a controlled start-up of one or more LSN-D3's, or if several output voltages need to be powered-up in a given sequence, the On/Off Control pin can be pulled high (external pull-up resistor, converter disabled) and then driven low with an external open collector device to enable the converter.

### Output Overvoltage Protection

LSN D3 SIP Series DC/DC converters do not incorporate output overvoltage protection. In the extremely rare situation in which the device's feedback loop is broken, the output voltage may run to excessively high levels ( $V_{OUT} = V_{IN}$ ). If it is absolutely imperative that you protect your load against any and all possible overvoltage situations, voltage limiting circuitry must be provided external to the power converter.

### Output Overcurrent Detection

Overloading the output of a power converter for an extended period of time will invariably cause internal component temperatures to exceed their maximum ratings and eventually lead to component failure. High-current-carrying components such as inductors, FET's and diodes are at the highest risk. LSN D3 SIP Series DC/DC converters incorporate an output overcurrent detection and shutdown function that serves to protect both the power converter and its load.

If the output current exceeds its maximum rating by typically 60% (16 Amps) or if the output voltage drops to less than 98% of its original value, the LSN D3's internal overcurrent-detection circuitry immediately turns off the converter, which then goes into a "hiccup" mode. While hiccupping, the converter will continuously attempt to restart itself, go into overcurrent, and then shut down. Under these conditions, the average output current will be approximately 400mA, and the average input current will be approximately 70mA. Once the output short is removed, the converter will automatically restart itself.

### Output Voltage Trimming

Allowable trim ranges for each model in the LSN D3 SIP Series are  $\pm 10\%$ . Trimming is accomplished with either a trimpot or a single fixed resistor. The trimpot should be connected between +Output and Common with its wiper connected to the Trim pin as shown in Figure 3 below.

A trimpot can be used to determine the value of a single fixed resistor which can then be connected, as shown in Figure 4, between the Trim pin and +Output to trim down the output voltage, or between the Trim pin and Common to trim up the output voltage. Fixed resistors should have absolute TCR's less than 100ppm/ $^{\circ}$ C to ensure stability.

The equations below can be used as starting points for selecting specific trim-resistor values. Recall, untrimmed devices are guaranteed to be  $\pm 1\%$  accurate.

Adjustment beyond the specified  $\pm 10\%$  adjustment range is not recommended.

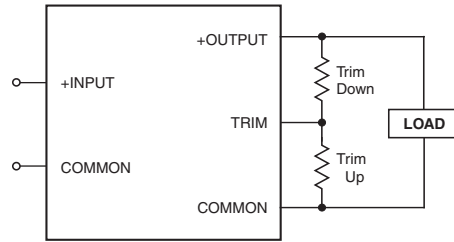

**Figure 3. Trim Connections Using a Trimpot**

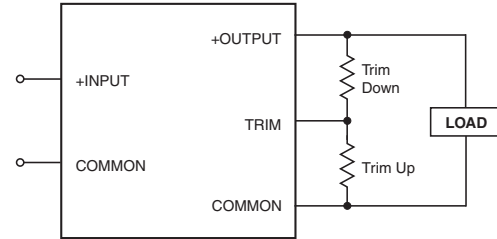

**Note:** Install either a fixed trim-up resistor or a fixed trim-down resistor depending upon desired output voltage.

**Figure 4. Trim Connections Using Fixed Resistors**

#### LSN-1/10-D3 Trim Equations

$$R_{T\_DOWN} (k\Omega) = \frac{1.62(V_O - 0.8)}{V_{O\_NOM} - V_O} - 1$$

$$R_{T\_UP} (k\Omega) = \frac{1.296}{V_O - V_{O\_NOM}} - 1$$

#### LSN-1.2/10-D3, LSN-1.25/10-D3 Trim Equations

$$R_{T\_DOWN} (k\Omega) = \frac{2.49(V_O - 0.8)}{V_{O\_NOM} - V_O} - 2.37$$

$$R_{T\_UP} (k\Omega) = \frac{1.992}{V_O - V_{O\_NOM}} - 2.37$$

#### LSN-1.5/10-D3, LSN-1.8/10-D3, LSN-2/10-D3, LSN-2.5/10-D3 Trim Equations

$$R_{T\_DOWN} (k\Omega) = \frac{2.37(V_O - 0.8)}{V_{O\_NOM} - V_O} - 4.99$$

$$R_{T\_UP} (k\Omega) = \frac{1.896}{V_O - V_{O\_NOM}} - 4.99$$

**Note:** Resistor values are in  $k\Omega$ . Accuracy of adjustment is subject to tolerances of resistors and factory-adjusted, initial output accuracy.  
 $V_O$  = desired output voltage.  $V_{O\_NOM}$  = nominal output voltage.

### Output Reverse Conduction

Many DC/DC converters using synchronous rectification suffer from Output Reverse Conduction. If those devices have a voltage applied across their output before a voltage is applied to their input (this typically occurs when another power supply starts before them in a power-sequenced application),

they will either fail to start or self destruct. In both cases, the cause is the "freewheeling" or "catch" FET biasing itself on and effectively becoming a short circuit.

LSN D3 SIP DC/DC converters are not damaged from Output Reverse Conduction. They employ proprietary gate drive circuitry which makes them immune to applied voltages during the startup sequence. If you are using an external power source paralleled with the LSN, be aware that during the start up phase, some low impedance condition or transient current may be absorbed briefly into the LSN output terminals before voltage regulation is fully established. You should insure that paralleled external power sources are not disrupted by this condition during LSN start up.

#### Thermal Considerations and Thermal Protection

The typical output-current thermal-derating curves shown above enable designers to determine how much current they can reliably derive from each model of the LSN D3 SIP's under known ambient-temperature and air-flow conditions. Similarly, the curves indicate how much air flow is required to reliably deliver a required output current at known temperatures.

The highest temperatures in LSN D3 SIP's occur at their output inductor, whose heat is generated primarily by  $I^2R$  losses. The curves below were developed using thermocouples to monitor the inductor temperature and varying the load to keep that temperature below +110°C under the assorted conditions of air flow and air temperature. Once the temperature exceeds

+115°C (approx.), the thermal protection will disable the converter. Automatic restart occurs after the temperature has dropped below +110°C.

In all cases below, the DUT's were vertical-mount models, and the direction of air flow was parallel to the unit in the direction from pin 1 to pin 11.

As you may deduce from the above curves and can observe in the efficiency curves on the next page, LSN D3 SIP's are more efficient at lower current levels. Also,  $I^2R$  losses in the output inductor are significantly less at lower currents. Consequently, LSN D3 SIP's deliver very impressive temperature performance if operating at less than full load.

Lastly, when LSN D3 SIP's are installed in system boards, they are obviously subject to numerous factors and tolerances not taken into account above. If you are attempting to extract the most current out of these units under demanding temperature conditions, we advise you to monitor the output-inductor temperature to ensure it remains below +110°C at all times.

#### Thermal Performance for "H" Models

Enhanced thermal performance can be achieved when LSN D3 SIP's are mounted horizontally ("H" models) and the output inductor (with its electrically isolating, thermally conductive pad installed) is thermally coupled to a copper plane/pad (at least 0.55 square inches in area) on the system board. Your conditions may vary, however our tests indicate this configuration delivers a 16°C to 22°C improvement in ambient operating temperatures.

### Start Up Considerations

When power is first applied to the DC/DC converter, operation is different than when the converter is running and stabilized. There is some risk of start up difficulties if you do not observe several application features. Lower input voltage converters may have more problems here since they tend to have higher input currents. Operation is most critical with any combination of the following external factors:

- 1 - Low initial input line voltage and/or poor regulation of the input source.
- 2 - Full output load current on lower output voltage converters.
- 3 - Slow slew rate of input voltage.
- 4 - Longer distance to input voltage source and/or higher external input source impedance.
- 5 - Limited or insufficient ground plane. External wiring that is too small.
- 6 - Too small external input capacitance. Too high ESR.
- 7 - High output capacitance causing a start up charge overcurrent surge.
- 8 - Output loads with excessive inductive reactance or constant current characteristics.

If the input voltage is already at the low limit before power is applied, the start up surge current may instantaneously reduce the voltage at the input terminals to below the specified minimum voltage. Even if this voltage depression is very brief, this may interfere with the on-board controller and possibly cause a failed start. Or the converter may start but the input current load will now drive the input voltage below its running low limit and the converter will shut down.

If you measure the input voltage before start up with a Digital Voltmeter (DVM), the voltage may appear to be adequate. Limited external capacitance and/or too high a source impedance may cause a short downward spike at power up, causing an instantaneous voltage drop. Use an oscilloscope not a DVM to observe this spike. The converter's soft-start controller is sensitive to input voltage. What matters here is the actual voltage at the input terminals at all times.

Symptoms of start-up difficulties may include failed started, output oscillation or brief start up then overcurrent shutdown. Since the input voltage is never absolutely constant, the converter may start up at some times and not at others.

### Solutions

To improve start up, review the conditions above. One of the better solutions is to place a moderate size capacitor very close to the input terminals. You may need two parallel capacitors. A larger electrolytic or tantalum cap supplies the surge current and a smaller parallel low-ESR ceramic cap gives low AC impedance. Too large an electrolytic capacitor may have higher internal impedance (ESR) and/or lower the start up slew rate enough to upset the DC/DC's controller. Make sure the capacitors can tolerate reflected switching current pulses from the converter.

The capacitors will not help if the input source has poor regulation. A converter which starts successfully at 3.3 Volts will turn off if the input voltage decays to below the input voltage threshold, regardless of external capacitance.

Increase the input start up voltage if possible to raise the downward voltage spike. Also, make sure that the input voltage ramps up in a reasonably short time (less than a few milliseconds). If possible, move the input source closer to the converter to reduce ohmic losses in the input wiring. Remember that the input current is carried both by the wiring and the ground plane return. Make sure the ground plane uses adequate thickness copper. Run additional bus wire if necessary.

Any added output capacitor should use just enough capacitance (and no more) to reduce output noise at the load and to avoid marginal threshold noise problems with external logic. An output cap will also "decouple" inductive reactance in the load. Certain kinds of electronic loads include "constant current" characteristics which destabilize the output with insufficient capacitance. If the wiring to the eventual load is long, consider placing this decoupling cap at the load. Use the Remote Sense input to avoid ohmic voltage drop errors.

An elegant solution to start up problems is to apply the input voltage with the Remote On/Off control first in the off setting (for those converters with an On/Off Control). After the specified start-up delay (usually under 20 mSec), turn on the converter. The controller will have already been stabilized. The short delay will not be noticed in most applications. Be aware of applications which need "power management" (phased start up).

Finally, it is challenging to model some application circuits with absolute fidelity. How low is the resistance of your ground plane? What is the inductance (and distributed capacitance) of external wiring? Even a detailed mathematical model may not get all aspects of your circuit. Therefore it is difficult to give cap values which serve all applications. Some experimentation may be required.

## Typical Performance Curves for LSN D3 SIP Series

**LSN-1/10-D3, LSN-1.2/10-D3, LSN-1.25/10-D3**

**Output Current vs. Ambient Temperature**

(Vertical mount, air flow direction from pin 1 to pin 11)

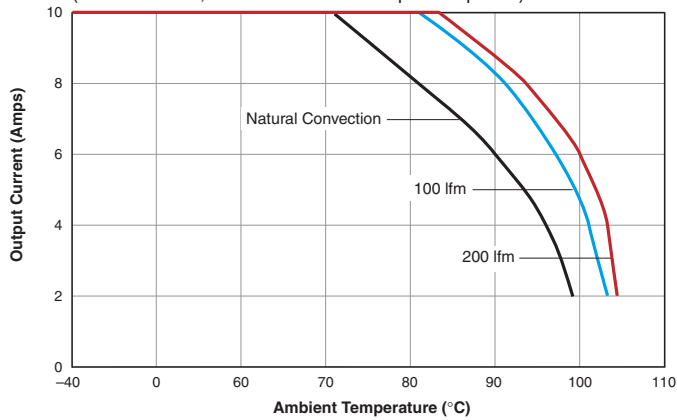

**LSN-2.5/10-D3**

**Output Current vs. Ambient Temperature**

(Vertical mount, air flow direction from pin 1 to pin 11)

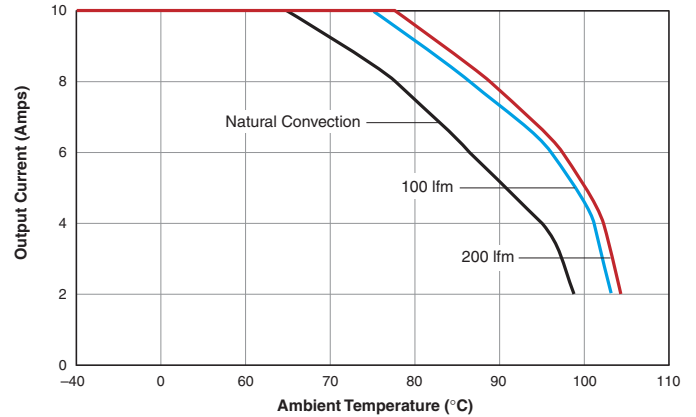

**LSN-1.8/10-D3 & LSN-2/10-D3**

**Output Current vs. Ambient Temperature**

(Vertical mount, air flow direction from pin 1 to pin 11)

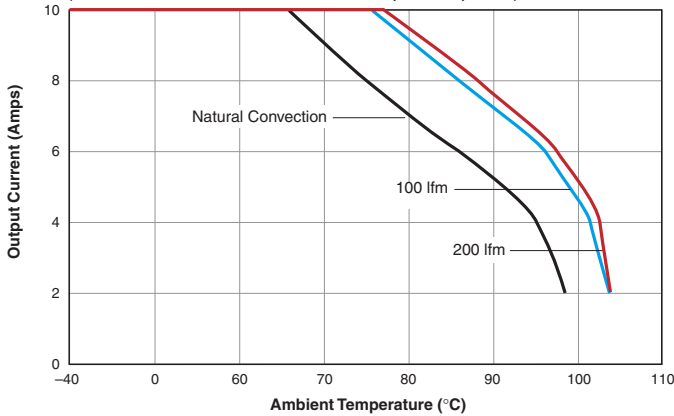

**LSN-1.5/10-D3**

**Output Current vs. Ambient Temperature**

(Vertical mount, air flow direction from pin 1 to pin 11)

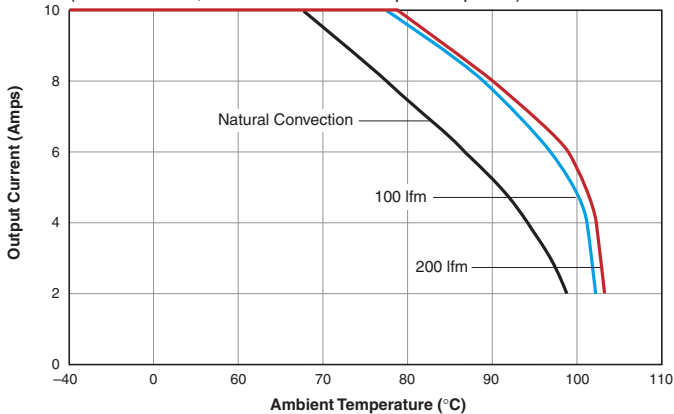

**LSM-1/10-D3**

**Efficiency vs. Line Voltage and Load Current**

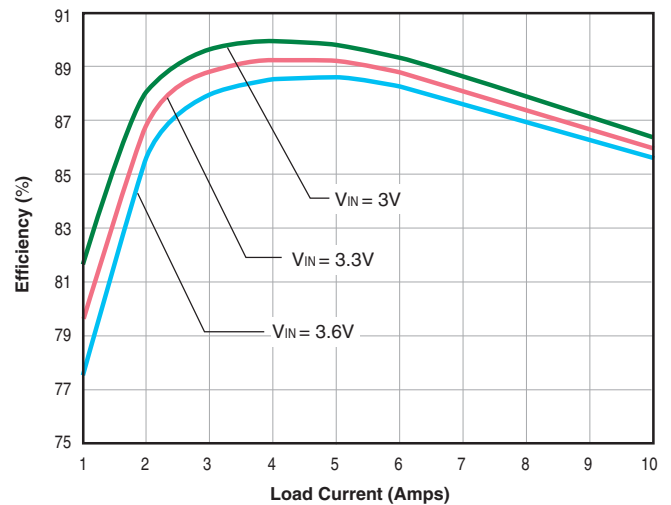

**LSM-1.2/10-D3**

**Efficiency vs. Line Voltage and Load Current**

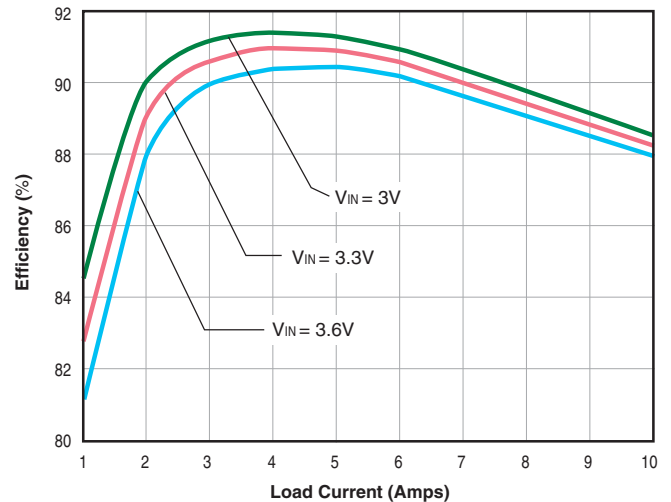



## Typical Performance Curves for LSN D3 SIP Series

**LSM-1.25/10-D3**  
Efficiency vs. Line Voltage and Load Current

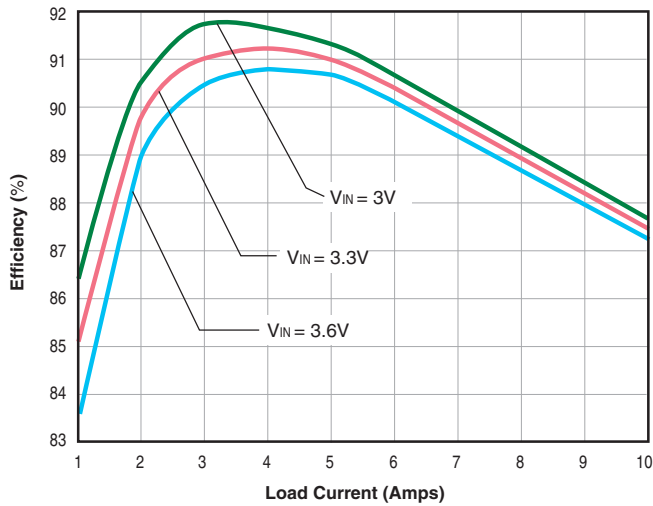

**LSM-2/10-D3**  
Efficiency vs. Line Voltage and Load Current

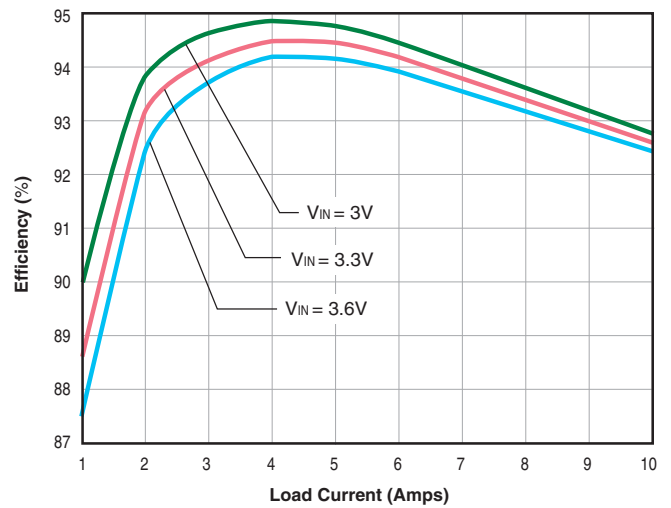

**LSM-1.5/10-D3**  
Efficiency vs. Line Voltage and Load Current

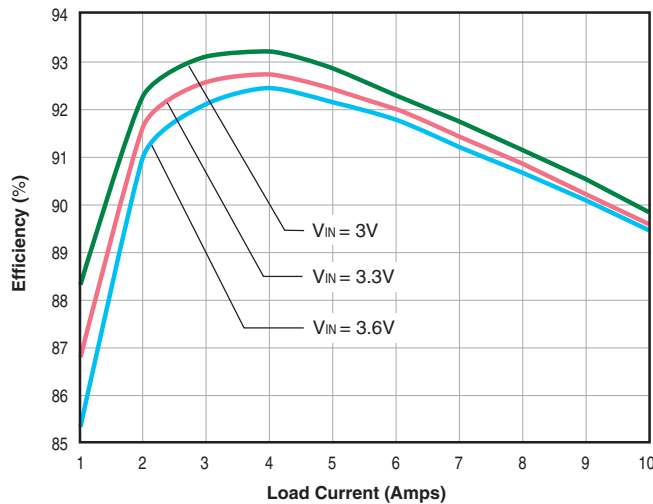

**LSM-2.5/10-D3**  
Efficiency vs. Line Voltage and Load Current

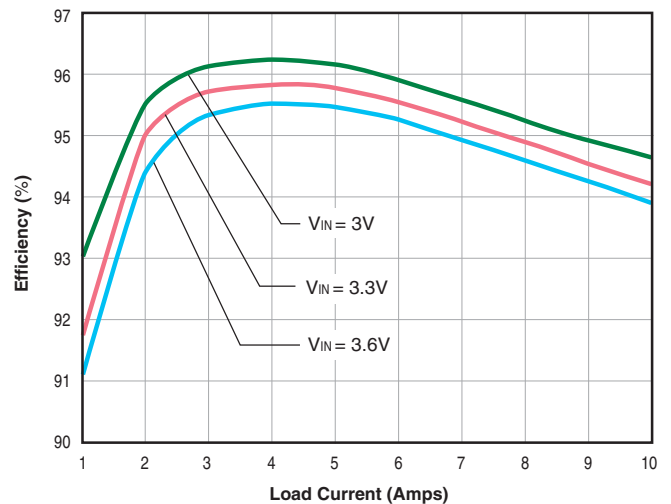

**LSM-1.8/10-D3**  
Efficiency vs. Line Voltage and Load Current

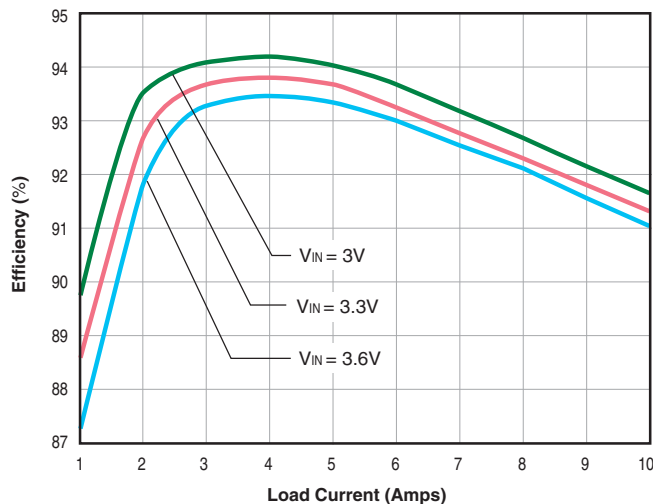

## Typical Performance Curves for LSN D3 SIP Series

**Input Inrush Current**  
(VIN = 3.3V, 4300µF as Input Switch)

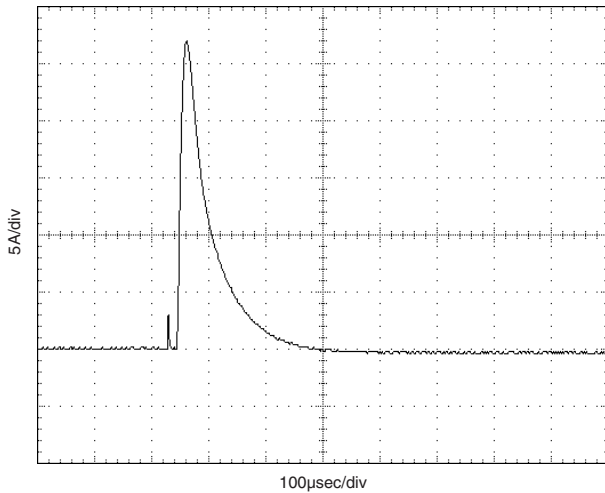

**Power-Up From VIN**  
(VIN = 3.3V, VOUT = 2.5V/10A, CIN/COU = 220µF)

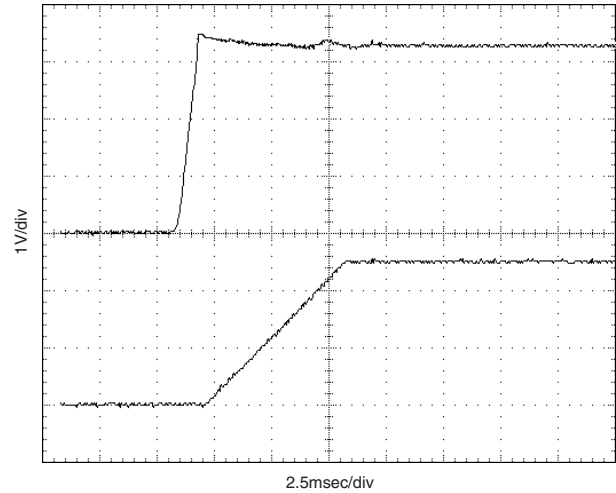

**Input Reflected Ripple Current**  
(VIN = 3.3V, VOUT = 2.5V/10A, CIN/COU = 220µF)

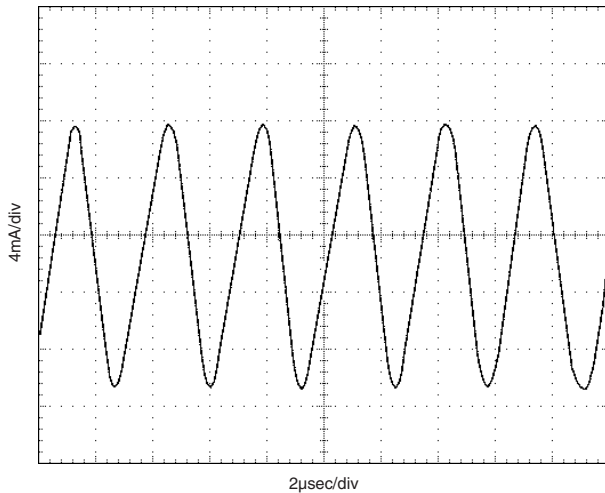

**Power-Up From Enable**  
(VIN = 3.3V, VOUT = 2.5V/10A, CIN/COU = 220µF)

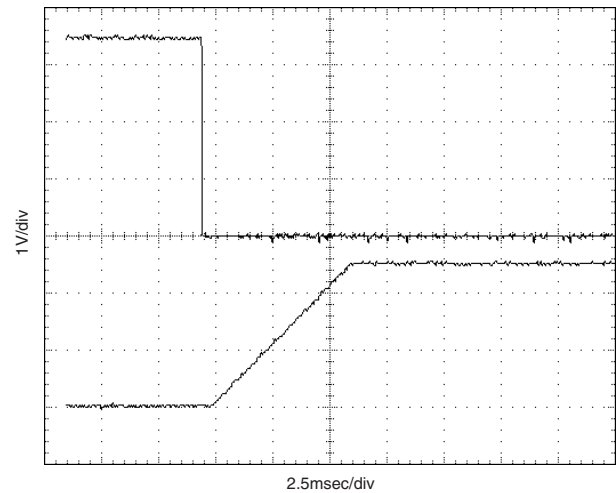

**Input Reflected Ripple Current**  
(VIN = 3.3V, VOUT = 2.5V/10A, Input Filter = 220µF/12µH/33µF, COU = 220µF)

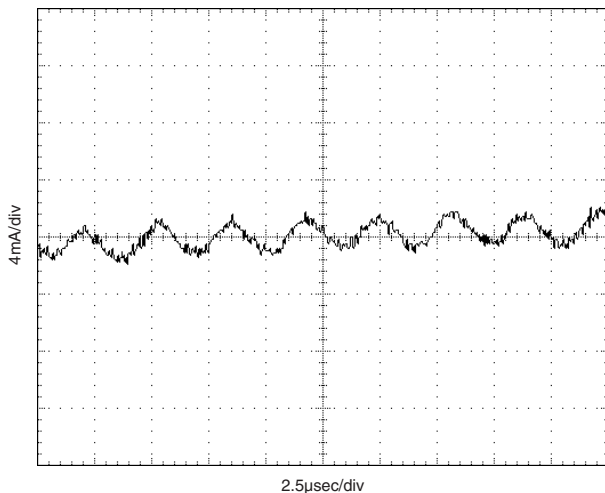

**Power-Up From Enable**  
(VIN = 3.3V, VOUT = 2.5V/10A, CIN = 220µF, COU = 5000µF, OSCON)

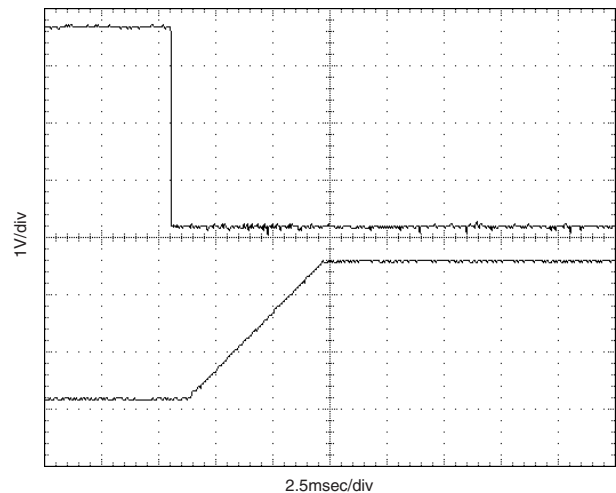

## Typical Performance Curves for LSN D3 SIP Series

**Output Ripple/Noise**  
(VIN = 3.3V, VOUT = 2.5V, Full Load, COUT = 220μF)

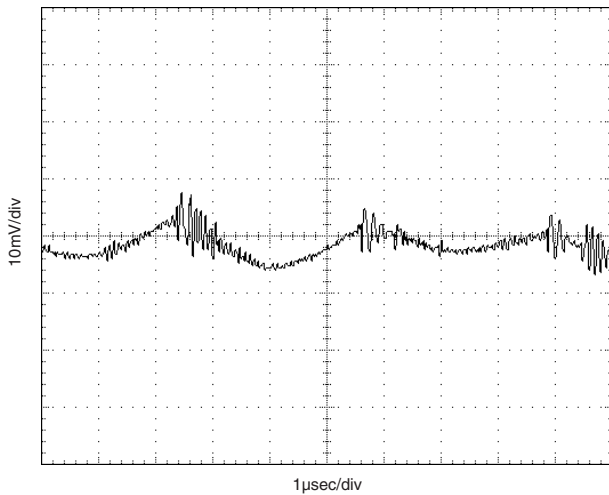

**Output Ripple/Noise**  
(VIN = 3.3V, VOUT = 2.5V, Full Load, No External Capacitor)

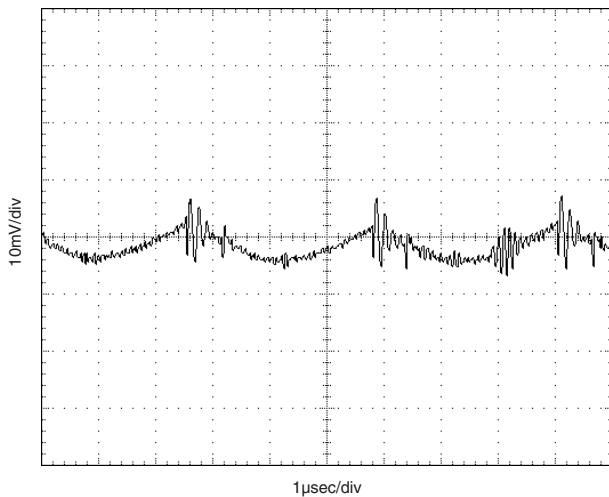

**Output Ripple/Noise**  
(VIN = 3.3V, VOUT = 2.5V, No Load, No External Capacitor)

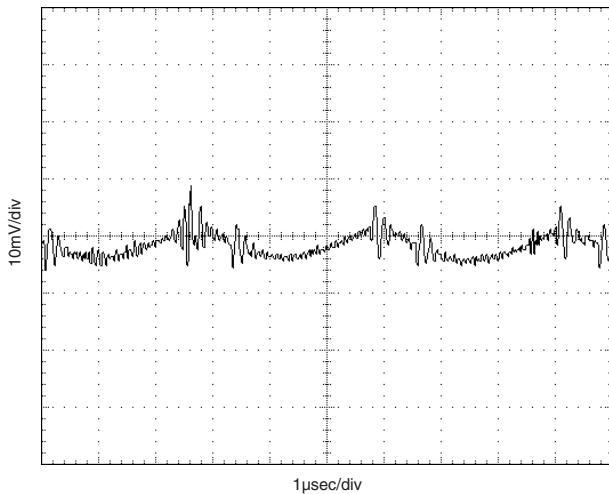

**Dynamic Load Response**  
(VIN = 3.3V, 100% to 50% Load Step, COUT = 220μF)

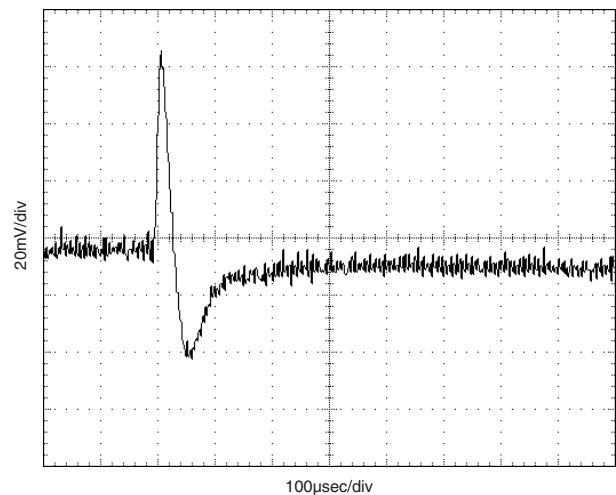

**Dynamic Load Response**  
(VIN = 3.3V, VOUT = 2.5V, 100% to 0% Load Step, No External COUT)

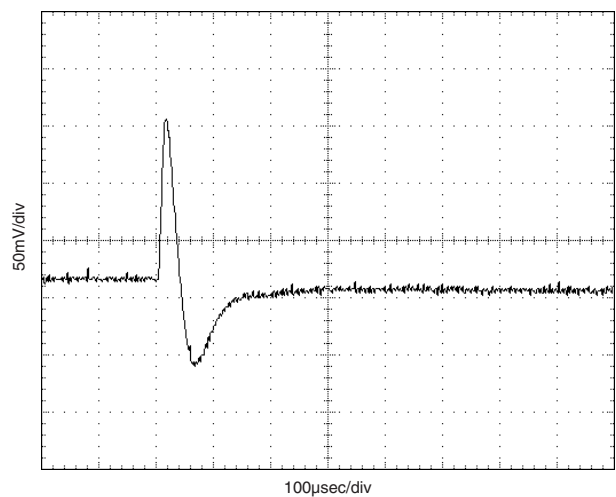

**Dynamic Load Response**  
(VIN = 3.3V, VOUT = 2.5V, 0% to 100% Load Step, COUT = 5000μF OSCON)

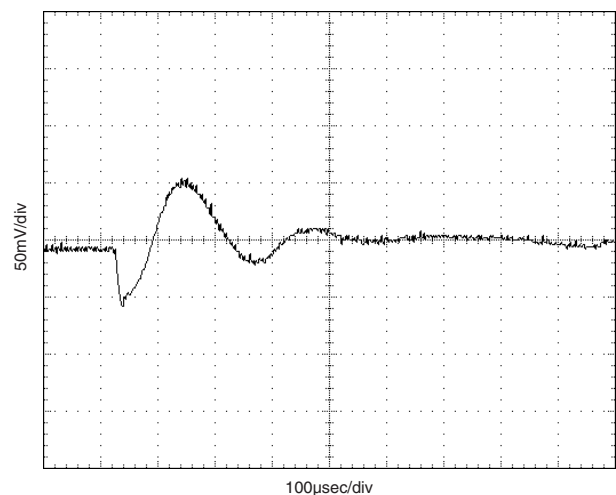

## Typical Performance Curves for LSN D3 SIP Series

### Output Hiccup

(V<sub>IN</sub> = 3.3V, V<sub>OUT</sub> = Short, I<sub>IN</sub> = 70mA Average,  
I<sub>OUT</sub> = 400mA Average, C<sub>IN</sub>/C<sub>OUT</sub> = 220μF)

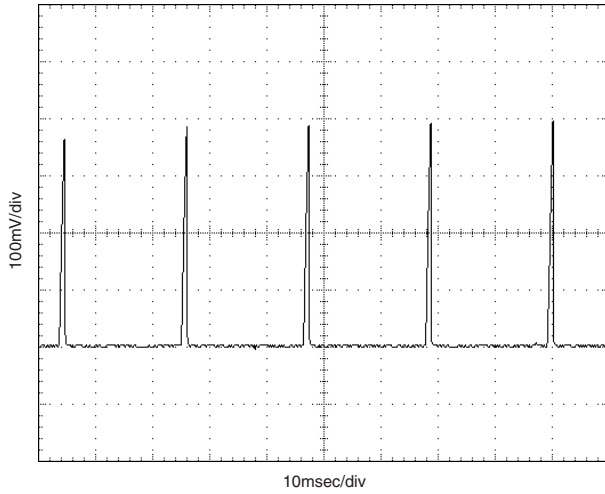

### Input Current with Short Circuit at Output

(V<sub>IN</sub> = 3.3V, V<sub>OUT</sub> = Short, I<sub>IN</sub> = 70mA Average,  
I<sub>OUT</sub> = 400mA Average, C<sub>IN</sub>/C<sub>OUT</sub> = 220μF, Period = 25msec )

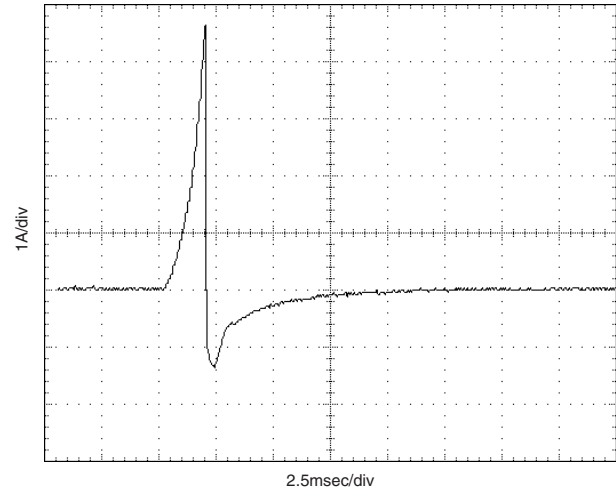

### Short-Circuit Output Current

(V<sub>IN</sub> = 3.3V, V<sub>OUT</sub> = Short, I<sub>IN</sub> = 70mA Average,  
I<sub>OUT</sub> = 400mA Average, C<sub>IN</sub>/C<sub>OUT</sub> = 220μF, Period = 25msec)

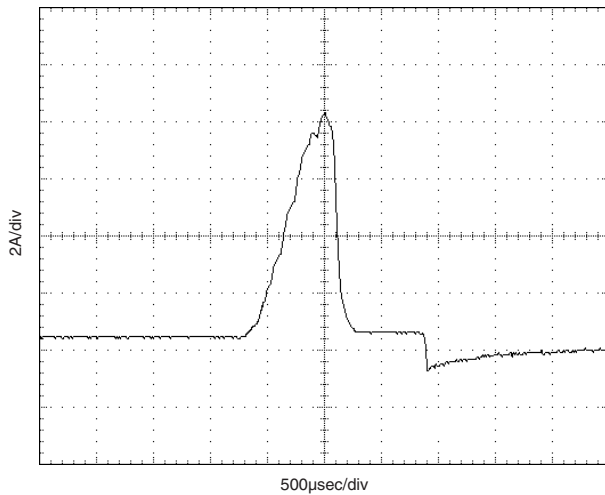

**EMI CONDUCTED/RADIATED EMISSIONS**

If you're designing with EMC in mind, please note that all of DATEL's LSN D3 DC/DC Converters have been characterized for conducted and radiated emissions in our EMI/EMC laboratory. Testing is conducted in an EMCO 5305 GTEM test cell utilizing EMCO automated EMC test software. Conducted/Radiated emissions are tested to the limits of FCC Part 15, Class B and CISPR 22 (EN 55022), Class B. Correlation to other specifications can be supplied upon request. The corresponding emissions plots to FCC and CISPR 22 for model LSN-2/10-D3 appear below.

**LSN-2/10-D3 Conducted Emissions**  
**FCC Part 15 Class B, EN55022 Class B Limit, +3.3Vdc @ 6.7A**  
**Converter Output = +2Vdc @ 10 Amps**

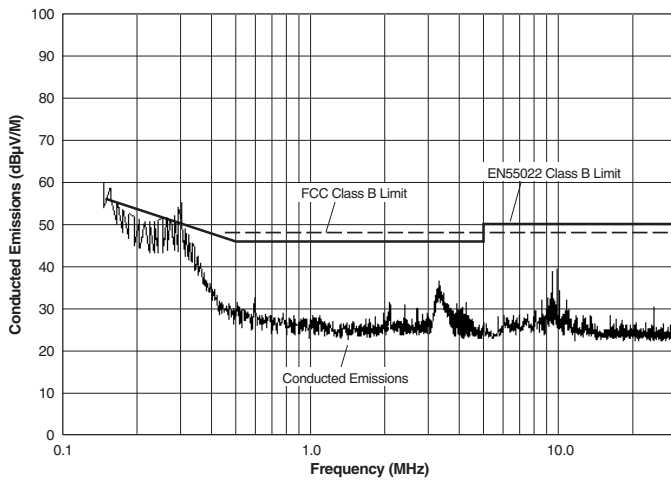

**LSN-2/10-D3 Radiated Emissions**  
**EN55022 Class B, 10 Meters**  
**Converter Output = +2Vdc @ +9.98 Amps**

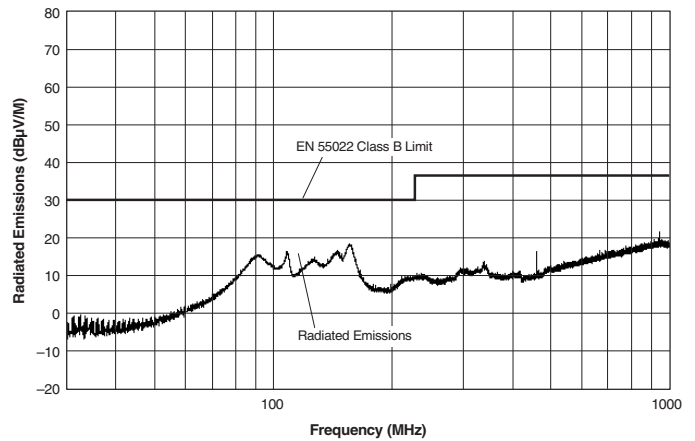

**LSN-2/10-D3 Radiated Emissions**  
**FCC Part 15 Class B, 3 Meters**  
**Converter Output = +2Vdc @ 9.98 Amps**

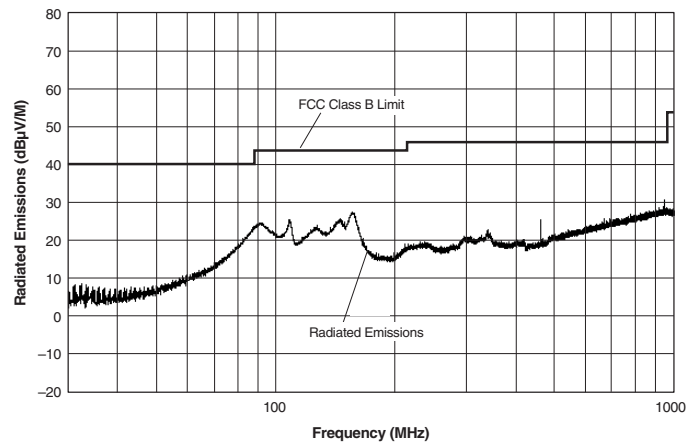

**PART NUMBER STRUCTURE**

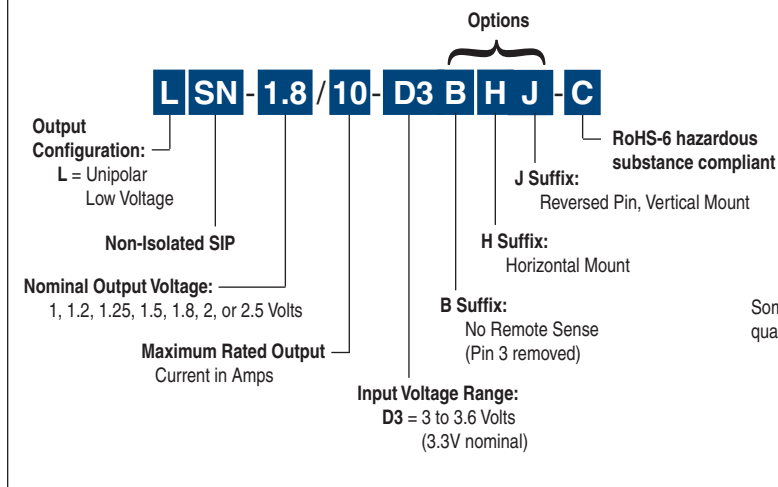

**Note:**  
Some model number combinations may not be available. Contact Murata Power Solutions (DATEL).

Some options may require a special quantity order.

### Functional Options

#### Remote Sense Pin Removed ("B" suffix)

These devices have their +Sense pin (pin 3) removed, and the feedback loop is closed through the +V<sub>OUT</sub> path. The 10.5Ω resistor in Figure 1 is installed in both standard and "B" models. See the Output Sense Function.

#### Horizontal Mounting ("H" suffix)

This packaging configuration reduces above-board height to 0.35" (8.89mm) including the "pad." For "H" models, a thermally conductive, electrically insulating "pad" is factory installed on the output inductor. The pad material is Bergquist Sil Pad 400. The pad size is 0.4 x 0.5 x 0.009 inches (10.16 x 12.7 x 0.23mm). This configuration can significantly improve thermal performance. See Thermal Derating for details.

#### Sense Pins

Note: If the sense pin is installed, it must be connected to either a remote load or to +output at the converter pins. Do not leave sense unconnected.

#### Reversed pin vertical mounting ("J" suffix)

This additional mechanical configuration consists of a low-profile pin header attached to the reverse side of the converter. It allows the LSN series to be mechanically compatible with Tyco's "keep out area."

#### Other Options and Modifications

Other options include a positive polarity (pull low to disable) on the On/Off Control. Contact Murata Power Solutions (DATEL) directly to discuss these and other possible modifications.

#### Examples

- LSN-1.8/10-D3** Vertical-mount. Sense function on pin 3. No pin 9.
- LSN-1.8/10-D3B** Vertical-mount. Pin 3 (+Sense) removed. No pin 9.
- LSN-1.8/10-D3H** Horizontal-mount. Sense function on pin 3. No pin 9.
- LSN-1.8/10-D3BH** Horizontal-mount. Pin 3 (+Sense) removed. No pin 9.
- LSN-1.8/10-D3J** Reverse pin vertical-mount. Sense function on pin 3. No pin 9.
- LSN-1.8/10-D3HJHL2-C** Reverse pin vertical mount, conformal coating added, special pin length, RoHS-6 hazardous substance compliance.