

<b>9-36 V</b> Cont. Input	<b>40 V</b> Trans. Input	<b>1.8-48 V</b> Outputs	<b>105 W</b> Max Power	<b>2250 V dc</b> Isolation	<b>Quarter-brick</b> DC-DC Converter
------------------------------	-----------------------------	----------------------------	---------------------------	-------------------------------	---

The InQor® quarter-brick converter series is composed of next-generation, board-mountable, isolated, fixed switching frequency dc-dc converters that use synchronous rectification to achieve extremely high power conversion efficiency. Each module is supplied completely encased to provide protection from the harsh environments seen in many industrial and transportation applications.



#### Operational Features

- High efficiencies, 83-91% at full rated load current
- Delivers full power with minimal derating - no heatsink required
- Operating input voltage range: 9-36 V, 40 V transient for 100 ms
- Fixed frequency switching provides predictable EMI
- No minimum load requirement

#### Mechanical Features

- Industry standard quarter-brick pin-out configuration
- Size: 1.54" x 2.39" x 0.50" (39.0 x 60.6 x 12.7mm)
- Total weight: 3 oz (85 g)

#### Control Features

- On/Off control referenced to input side
- Remote sense for the output voltage
- Output voltage trim range of -20%, +10%

#### Safety Features

- 2250 V, 30 MΩ input-to-output isolation
- UL/cUL 60950-1 recognized (US & Canada), basic insulation rating
- TUV certified to EN60950-1
- Meets 72/23/EEC and 93/68/EEC directives which facilitates CE Marking in user's end product
- Board and plastic components meet UL94V-0 standard
- RoHS compliant (see Page 28)

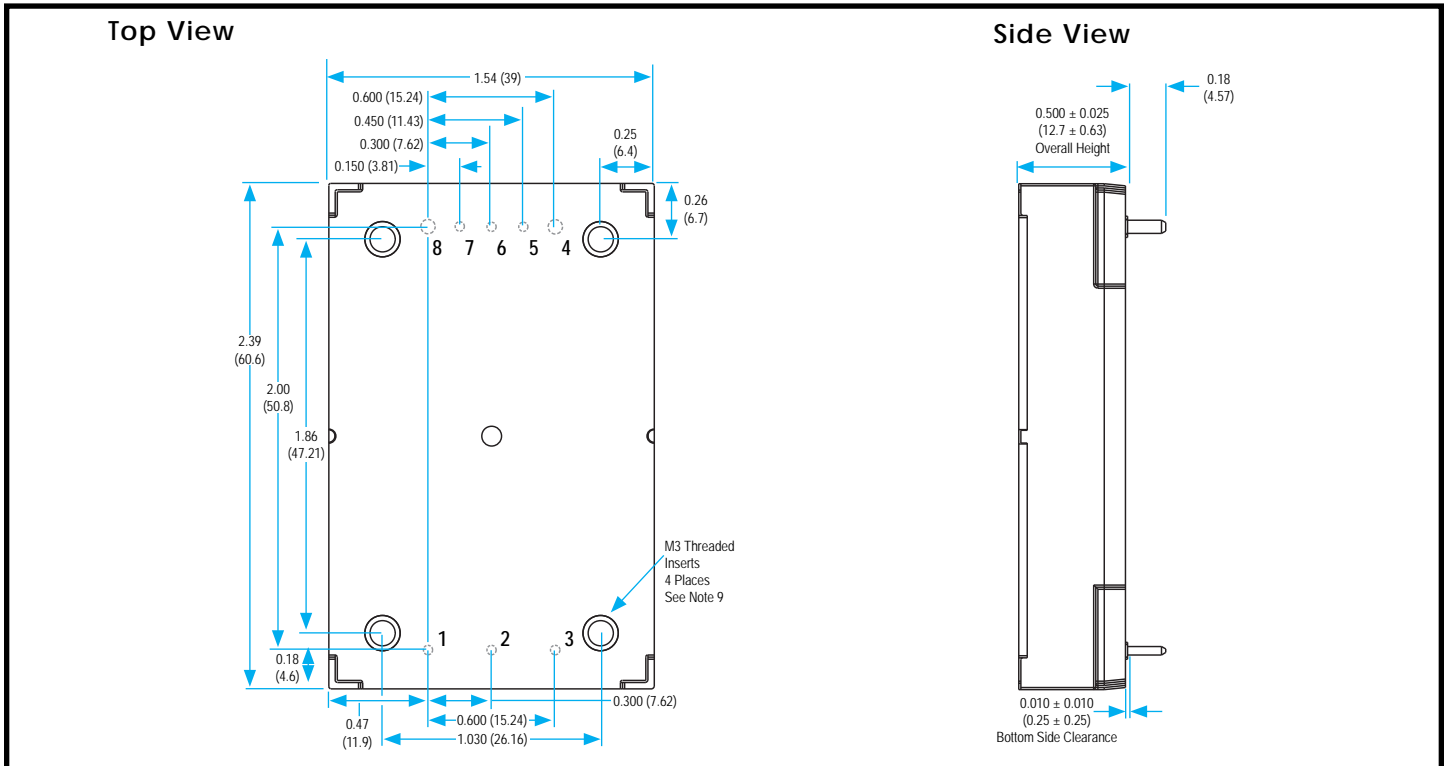
#### Protection Features

- Input under-voltage lockout
- Output current limit and short circuit protection
- Active back bias limit
- Output over-voltage protection
- Thermal shutdown

#### CONTENTS

	Page No.
Mechanical Drawing . . . . .	2
IQ18 Family Electrical Characteristics . . . . .	3 - 4
IQ18 Family Figures . . . . .	5
IQ18018QTC40 (1.8V, 40A) Characteristics and Figures . . . . .	6 - 7
IQ18033QTC30 (3.3V, 30A) Characteristics and Figures . . . . .	8 - 9
IQ18050QTC20 (5.0V, 20A) Characteristics and Figures . . . . .	10 - 11
IQ18070QTC14 (7.0V, 14A) Characteristics and Figures . . . . .	12 - 13
IQ18120QTC08 (12V, 8.0A) Characteristics and Figures . . . . .	14 - 15
IQ18150QTC07 (15V, 7.0A) Characteristics and Figures . . . . .	16 - 17
IQ18240QTC04 (24V, 4.0A) Characteristics and Figures . . . . .	18 - 19
IQ18300QTC03 (30V, 3.0A) Characteristics and Figures . . . . .	20 - 21
IQ18480QTC02 (48V, 2.0A) Characteristics and Figures . . . . .	22 - 23
Application Notes . . . . .	24 - 27
Ordering Information . . . . .	28

### MECHANICAL DIAGRAM



### NOTES

- 1) Pins 1-3, 5-7 are 0.040" (1.02mm) diameter with 0.080" (2.03 mm) diameter standoff shoulders.
- 2) Pins 4 and 8 are 0.062" (1.57 mm) diameter with 0.100" (2.54 mm) diameter standoff shoulders.
- 3) Recommended pin length is 0.03" (0.76mm) greater than the PCB thickness.
- 4) All Pins: Material - Copper Alloy; Finish - Matte Tin over Nickel plate
- 5) Undimensioned components shown are for visual reference only.
- 6) Weight: 3.02 oz. (85.7 g) typical
- 7) All dimensions in inches (mm)  
Tolerances: x.xx +/-0.02 in. (x.x +/-0.5mm)  
x.xxx +/-0.010 in. (x.xxx +/-0.25mm)
- 8) Workmanship: Meets or exceeds current IPC-A-610 Class II
- 9) M3 screws used to bolt unit's baseplate to other surfaces (such as a heatsink) must not exceed 0.100" (2.54 mm) depth below the surface of the baseplate.
- 10) Applied torque per screw should not exceed 6in-lb. (0.7 Nm).
- 11) Baseplate flatness tolerance is 0.004" (.10mm) TIR for surface.

### PIN DESIGNATIONS

Pin No.	Name	Function
1	Vin (+)	Positive input voltage
2	ON/OFF	TTL input to turn converter on and off, referenced to Vin (-) with internal pull up
3	Vin (-)	Negative input voltage
4	Vout (-)	Negative output voltage
5	SENSE (-)	Negative remote sense <sup>1</sup>
6	TRIM	Output voltage trim <sup>2</sup>
7	SENSE (+)	Positive remote sense <sup>3</sup>
8	Vout (+)	Positive output voltage

#### Notes:

1. SENSE(-) should be connected to Vout(-) either remotely or at the converter.
2. Leave TRIM pin open for nominal output voltage.
3. SENSE(+) should be connected to Vout(+) either remotely or at the converter.

### IQ18 FAMILY ELECTRICAL CHARACTERISTICS (all output voltages)

$T_A = 25\text{ }^\circ\text{C}$ , airflow rate = 300 LFM,  $V_{IN} = 18\text{ V}_{DC}$  unless otherwise noted; full operating temperature range is  $-40\text{ }^\circ\text{C}$  to  $+100\text{ }^\circ\text{C}$  ambient temperature with appropriate power derating. Specifications subject to change without notice.

Parameter	Min.	Typ.	Max.	Units	Notes & Conditions
<b>ABSOLUTE MAXIMUM RATINGS</b>					
Input Voltage					
Non-Operating			40	V	Continuous
Operating			36	V	Continuous
Operating Transient Protection			40	V	100 ms transient, square wave
Isolation Voltage					Basic insulation, Pollution Degree 2
Input to Output			2250	Vdc	
Input to Base-Plate			2250	Vdc	
Output to Base-Plate			2250	Vdc	
Operating Temperature	-40		100	$^\circ\text{C}$	Baseplate temperature
Storage Temperature	-55		125	$^\circ\text{C}$	
Voltage at ON/OFF input pin	-2		18	V	
<b>INPUT CHARACTERISTICS</b>					
Operating Input Voltage Range	9	18	36	V	40 V transient for 100 ms
Input Under-Voltage Lockout					
Turn-On Voltage Threshold	10.0	10.3	10.5	V	
Turn-Off Voltage Threshold	8.0	8.3	8.6	V	
Lockout Voltage Hysteresis		2		V	
Recommended External Input Capacitance		470		$\mu\text{F}$	Typical ESR 0.1-0.2 $\Omega$
<b>DYNAMIC CHARACTERISTICS</b>					
Turn-On Transient					
Turn-On Time		9		ms	Full load, $V_{out}=90\%$ nom.
Start-Up Inhibit Time	200	230	250	ms	See Figure F
Output Voltage Overshoot		0		%	Maximum Output Capacitance
<b>ISOLATION CHARACTERISTICS</b>					
Isolation Voltage (dielectric strength)					See Absolute Maximum Ratings
Isolation Resistance		30		$\text{M}\Omega$	
Isolation Capacitance (input to output) <sup>1</sup>		1000		pF	
<b>TEMPERATURE LIMITS FOR POWER DERATING CURVES</b>					
Semiconductor Junction Temperature			125	$^\circ\text{C}$	Package rated to 150 $^\circ\text{C}$
Board Temperature			125	$^\circ\text{C}$	UL rated max operating temp 130 $^\circ\text{C}$
Transformer Temperature			125	$^\circ\text{C}$	See Common Figure 3 for derating curve
Maximum Baseplate Temperature, $T_B$			100	$^\circ\text{C}$	
<b>FEATURE CHARACTERISTICS</b>					
Switching Frequency	230	250	270	kHz	Regulation and Isolation stages
ON/OFF Control					
Off-State Voltage	2.4		18	V	
On-State Voltage	-2		0.8	V	
ON/OFF Control					Common Figures A & B
Pull-Up Voltage		5		V	
Pull-Up Resistance		50		$\text{k}\Omega$	
Over-Temperature Shutdown		125		$^\circ\text{C}$	Average PCB Temperature
Over-Temperature Shutdown Restart Hysteresis		10		$^\circ\text{C}$	
<b>RELIABILITY CHARACTERISTICS</b>					
Calculated MTBF (Telcordia) TR-NWT-000332		2.5		$10^6$ Hrs	80% load, 300LFM, 40 $^\circ\text{C}$ $T_A$
Calculated MTBF (MIL-217) MIL-HDBK-217F		2.0		$10^6$ Hrs	80% load, 300LFM, 40 $^\circ\text{C}$ $T_A$
Field Demonstrated MTBF				$10^6$ Hrs	See our website for details

**Note 1:** Higher values of isolation capacitance can be added external to the module.

### IQ18 FAMILY STANDARDS AND QUALIFICATIONS (all output voltages)

$T_A = 25\text{ }^\circ\text{C}$ , airflow rate = 300 LFM,  $V_{IN} = 18\text{ V}_{DC}$  unless otherwise noted; full operating temperature range is  $-40\text{ }^\circ\text{C}$  to  $+100\text{ }^\circ\text{C}$  ambient temperature with appropriate power derating. Specifications subject to change without notice.

#### STANDARDS COMPLIANCE

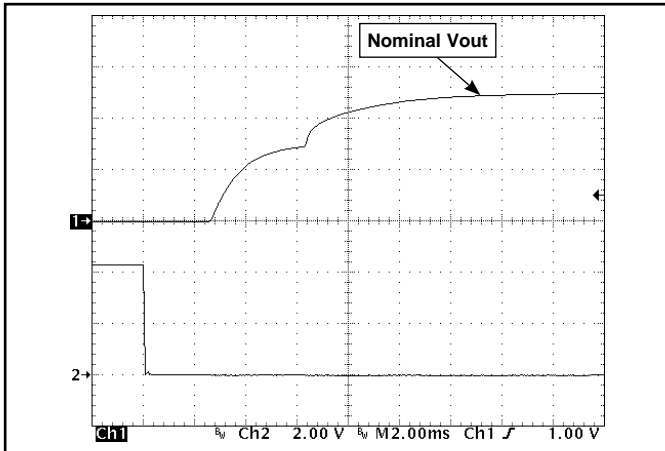
Parameter	Notes & Conditions
<b>STANDARDS COMPLIANCE</b>	
UL/cUL 60950-1	File # E194341, Basic insulation
EN60950-1	Certified by TUV
Needle Flame Test (IEC 695-2-2)	Test on entire assembly; board & plastic components UL94V-0 compliant
IEC 61000-4-2	ESD test, 8 kV - NP, 15 kV air - NP (Normal Performance)

Note: An external input fuse must always be used to meet these safety requirements. Contact SynQor for official safety certificates on new releases or download from the SynQor website.

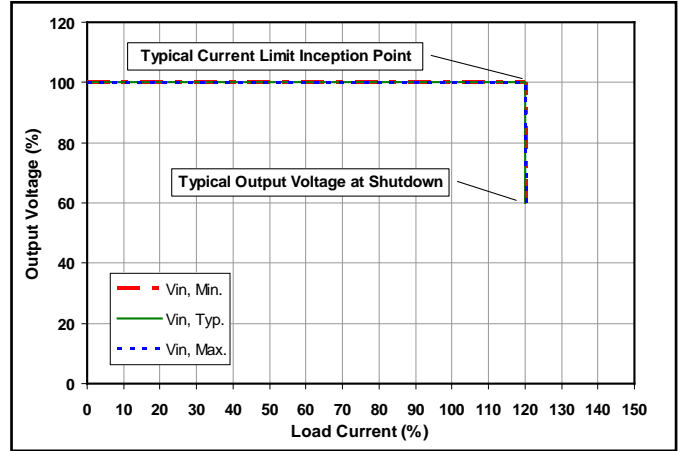
#### QUALIFICATION TESTING

Parameter	# Units	Test Conditions
<b>QUALIFICATION TESTING</b>		
Life Test	32	95% rated $V_{in}$ and load, units at derating point, 1000 hours
Vibration	5	10-55 Hz sweep, 0.060" total excursion, 1 min./sweep, 120 sweeps for 3 axis
Mechanical Shock	5	100g minimum, 2 drops in x and y axis, 1 drop in z axis
Temperature Cycling	10	$-40\text{ }^\circ\text{C}$ to $100\text{ }^\circ\text{C}$ , unit temp. ramp $15\text{ }^\circ\text{C}/\text{min.}$ , 500 cycles
Power/Thermal Cycling	5	Toperating = min to max, $V_{in}$ = min to max, full load, 100 cycles
Design Marginality	5	$T_{min}-10\text{ }^\circ\text{C}$ to $T_{max}+10\text{ }^\circ\text{C}$ , $5\text{ }^\circ\text{C}$ steps, $V_{in}$ = min to max, 0-105% load
Humidity	5	$85\text{ }^\circ\text{C}$ , 85% RH, 1000 hours, continuous $V_{in}$ applied except 5 min/day
Solderability	15 pins	MIL-STD-883, method 2003

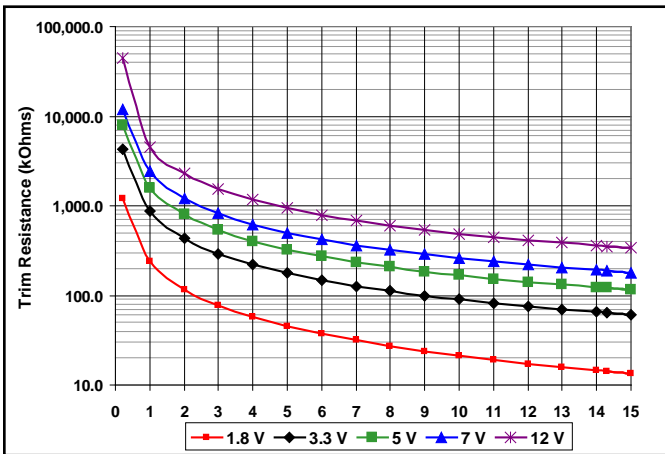
## IQ18 FAMILY FIGURES (all output voltages)



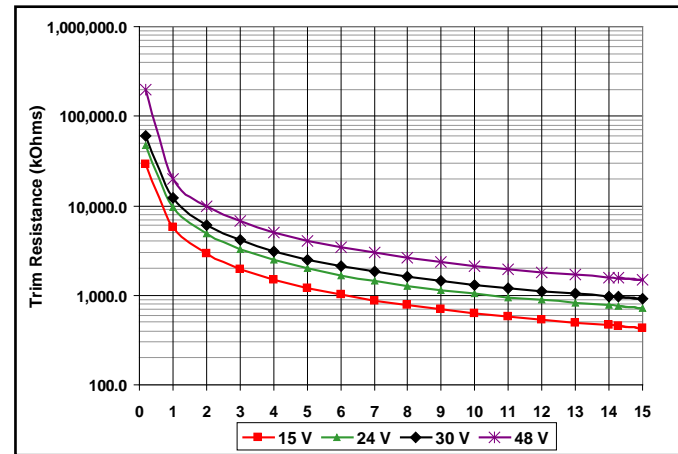
Common Figure 1: Typical startup waveform. Input voltage pre-applied, ON/OFF Pin on Ch 2.



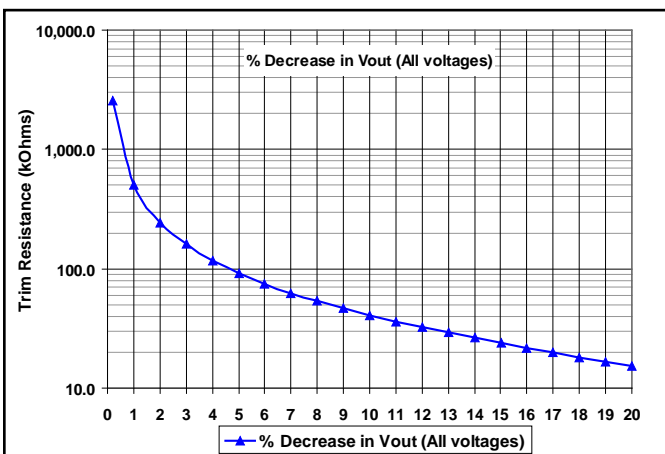
Common Figure 2: Output voltage vs. load current showing typical current limit curves and converter shutdown points.



Common Figure 3: Trim graph for trim-up 1.8 to 12 V outputs.



Common Figure 4: Trim graph for trim-up 15 to 48 V outputs.



Common Figure 5: Trim graph for trim down.

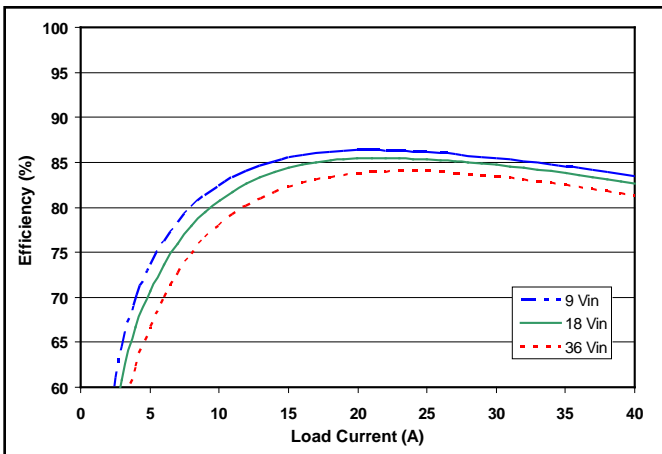
## IQ18018QTC40 ELECTRICAL CHARACTERISTICS (1.8 V<sub>OUT</sub>)

T<sub>A</sub> = 25 °C, airflow rate = 300 LFM, V<sub>IN</sub> = 18 V<sub>DC</sub> unless otherwise noted; full operating temperature range is -40 °C to +100 °C ambient temperature with appropriate power derating. Specifications subject to change without notice.

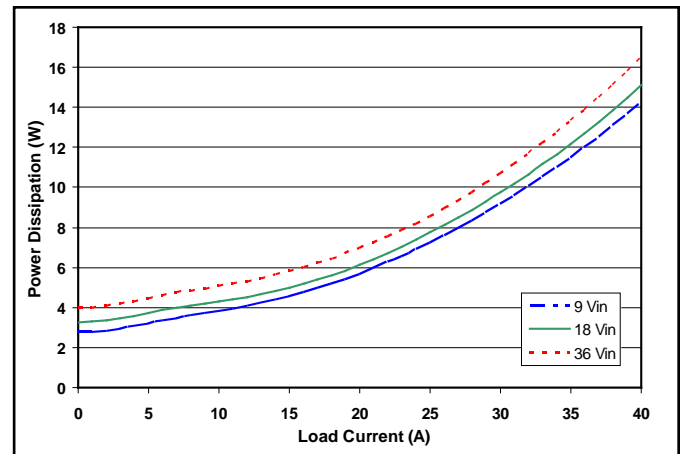
Parameter	Min.	Typ.	Max.	Units	Notes & Conditions
<b>INPUT CHARACTERISTICS</b>					
Maximum Input Current			12.8	A	9 V <sub>IN</sub> ; trim up; in current limit
No-Load Input Current		182	230	mA	
Disabled Input Current		2.5	4.0	mA	
Response to Input Transient		0.18		V	300 V/ms input transient; 100 μF output cap.
Input Terminal Ripple Current		285		mA	RMS
Recommended Input Fuse			30	A	Fast acting external fuse recommended
Input Filter Component Values (L\C)		0.47\18		μH\μF	Internal values; see Figure E
<b>OUTPUT CHARACTERISTICS</b>					
Output Voltage Set Point	1.782	1.800	1.818	V	
Output Voltage Regulation					
Over Line		+0.1	+0.3	%	
Over Load		+0.1	+0.3	%	
Over Temperature	-27		27	mV	
Total Output Voltage Range	1.755		1.845	V	Over sample, line, load, temperature & life
Output Voltage Ripple and Noise <sup>1</sup>					20 MHz bandwidth
Peak-to-Peak		106	210	mV	Full Load
RMS		16	30	mV	Full Load
Operating Output Current Range	0		40	A	Subject to thermal derating
Output DC Current-Limit Inception	44	48	52	A	Output Voltage 10% Low
Output DC Current-Limit Shutdown Voltage		0.9		V	
Back-Drive Current Limit while Enabled		1.1		A	Negative current drawn from output
Back-Drive Current Limit while Disabled	0	15	50	mA	Negative current drawn from output
Maximum Output Capacitance			10,000	μF	V <sub>out</sub> nominal at full load (resistive load)
Output Voltage during Load Current Transient					
For a Step Change in Output Current (0.1 A/μs)		88		mV	50% to 75% to 50% I <sub>OUT</sub> max
Settling Time		100		μs	To within 1% V <sub>OUT</sub> nom
Output Voltage Trim Range	-20		+10	%	Measured across Pins 8 & 4; Common Figure 3
Output Voltage Remote Sense Range			+10	%	Measured across Pins 8 & 4
Output Over-Voltage Protection	117	122	127	%	Over full temp range; % of nominal V <sub>OUT</sub>
Load Current Scale Factor		2667			See Output Load Current app. note on our web
<b>EFFICIENCY</b>					
100% Load		83		%	See Figure 1 for efficiency curve
50% Load		85		%	See Figure 1 for efficiency curve

**Note 1:** Output is terminated with 1 μF ceramic and 15 μF low-ESR tantalum capacitors.

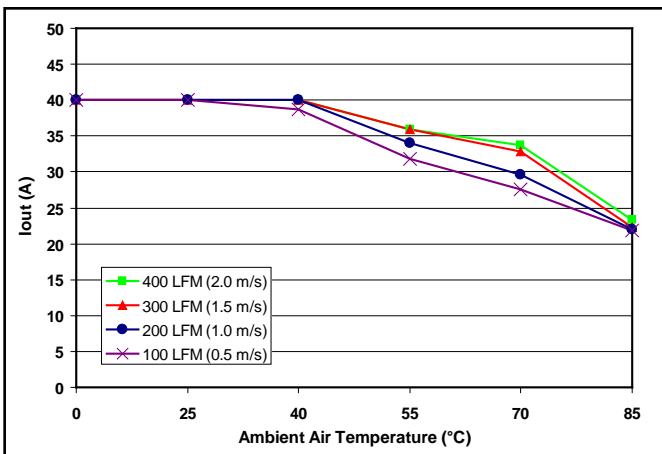
For applications requiring reduced output voltage ripple and noise, consult SynQor applications support (e-mail: support@synqor.com)



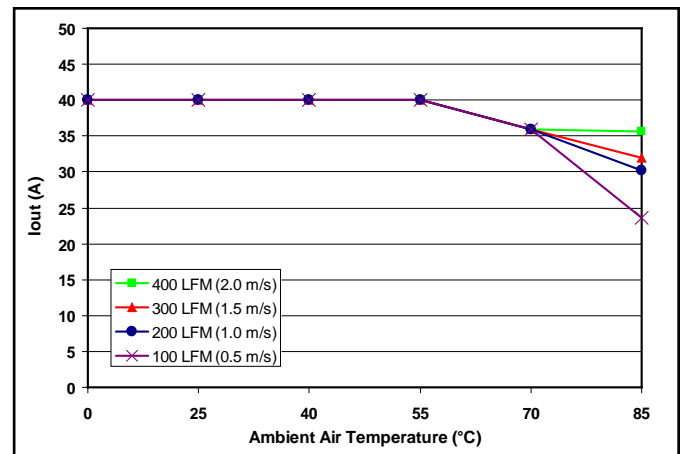
**Figure 1:** Efficiency at nominal output voltage vs. load current for minimum, nominal, and maximum input voltage at 25°C.



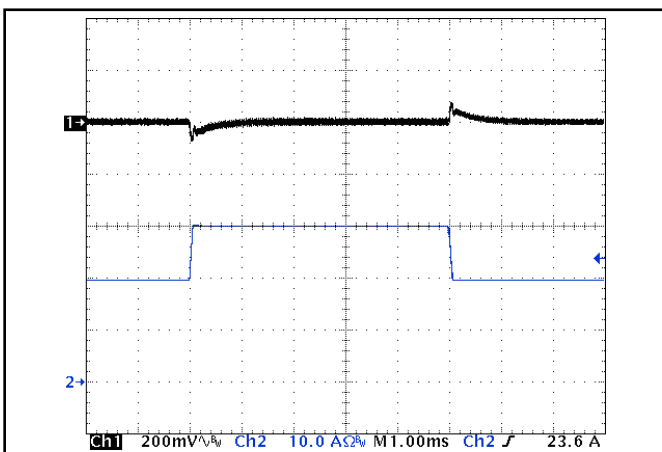
**Figure 2:** Power dissipation at nominal output voltage vs. load current for minimum, nominal, and maximum input voltage at 25°C.



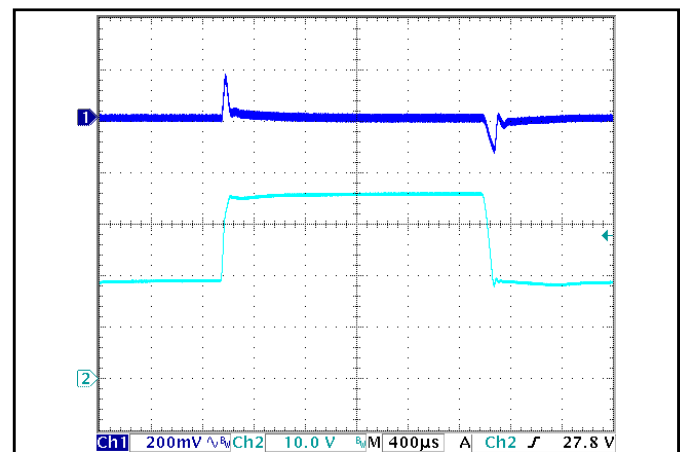
**Figure 3:** Encased converter (without heatsink) max. output power derating vs. ambient air temperature for airflow rates of 100 LFM through 400 LFM. Air flows across the converter from pin 3 to pin 1 (nominal input voltage).



**Figure 4:** Encased converter (with 1/4" heatsink) max. output power derating vs. ambient air temperature for airflow rates of 100 LFM through 400 LFM. Air flows across the converter from pin 3 to pin 1 (nominal input voltage).



**Figure 5:** Output voltage response to step-change in load current (50%-75%-50% of I<sub>out</sub>(max); dl/dt = 0.2 A/μs). Load cap: 1 μF ceramic and 15 μF tantalum capacitors. Ch 1: V<sub>out</sub> (200 mV/div), Ch 2: I<sub>out</sub> (10 A/div).



**Figure 6:** Output voltage response to step-change in input voltage (300 V/ms). Load cap: 100 μF, electrolytic output capacitance. Ch 1: V<sub>out</sub> (200 mV/div), Ch 2: V<sub>in</sub> (10 V/div).

## IQ18033QTC30 ELECTRICAL CHARACTERISTICS (3.3 V<sub>OUT</sub>)

T<sub>A</sub> = 25 °C, airflow rate = 300 LFM, V<sub>IN</sub> = 18 V<sub>DC</sub> unless otherwise noted; full operating temperature range is -40 °C to +100 °C ambient temperature with appropriate power derating. Specifications subject to change without notice.

Parameter	Min.	Typ.	Max.	Units	Notes & Conditions
<b>INPUT CHARACTERISTICS</b>					
Maximum Input Current			16.7	A	9 V <sub>IN</sub> ; trim up; in current limit
No-Load Input Current		172	220	mA	
Disabled Input Current		2.4	4.0	mA	
Response to Input Transient		0.16		V	300 V/ms input transient; 100 μF output cap.
Input Terminal Ripple Current		400		mA	RMS
Recommended Input Fuse			30	A	Fast acting external fuse recommended
Input Filter Component Values (L\C)		0.47\18		μH\μF	Internal values; see Figure E
<b>OUTPUT CHARACTERISTICS</b>					
Output Voltage Set Point	3.267	3.300	3.333	V	
Output Voltage Regulation					
Over Line		+0.1	+0.3	%	
Over Load		+0.1	+0.3	%	
Over Temperature	-50		50	mV	
Total Output Voltage Range	3.218		3.383	V	Over sample, line, load, temperature & life
Output Voltage Ripple and Noise <sup>1</sup>					20 MHz bandwidth
Peak-to-Peak		66	130	mV	Full Load
RMS		10	20	mV	Full Load
Operating Output Current Range	0		30	A	Subject to thermal derating
Output DC Current-Limit Inception	33	36	39	A	Output Voltage 10% Low
Output DC Current-Limit Shutdown Voltage		1.7		V	
Back-Drive Current Limit while Enabled		0.85		A	Negative current drawn from output
Back-Drive Current Limit while Disabled	0	15	50	mA	Negative current drawn from output
Maximum Output Capacitance			10,000	μF	V <sub>out</sub> nominal at full load (resistive load)
Output Voltage during Load Current Transient					
For a Step Change in Output Current (0.1 A/μs)		125		mV	50% to 75% to 50% I <sub>OUT</sub> max
Settling Time		50		μs	To within 1% V <sub>OUT</sub> nom
Output Voltage Trim Range	-20		+10	%	Measured across Pins 8 & 4; Common Figure 3
Output Voltage Remote Sense Range			+10	%	Measured across Pins 8 & 4
Output Over-Voltage Protection	117	122	127	%	Over full temp range; % of nominal V <sub>OUT</sub>
Load Current Scale Factor		1333			See Output Load Current app. note on our web
<b>EFFICIENCY</b>					
100% Load		87		%	See Figure 1 for efficiency curve
50% Load		89		%	See Figure 1 for efficiency curve

**Note 1:** Output is terminated with 1 μF ceramic and 15 μF low-ESR tantalum capacitors.

For applications requiring reduced output voltage ripple and noise, consult SynQor applications support (e-mail: support@synqor.com)



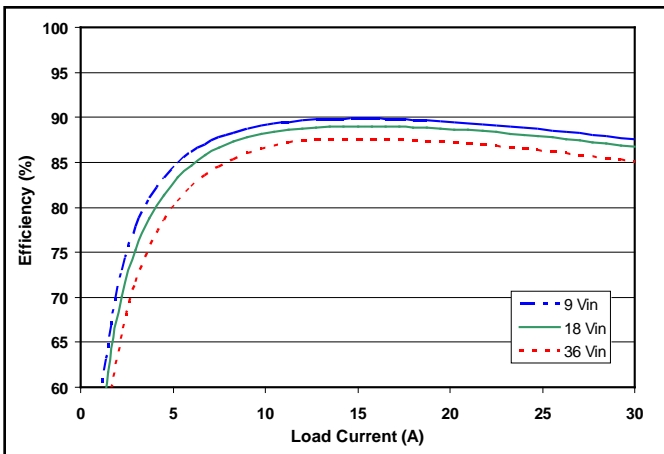


Figure 1: Efficiency at nominal output voltage vs. load current for minimum, nominal, and maximum input voltage at 25°C.

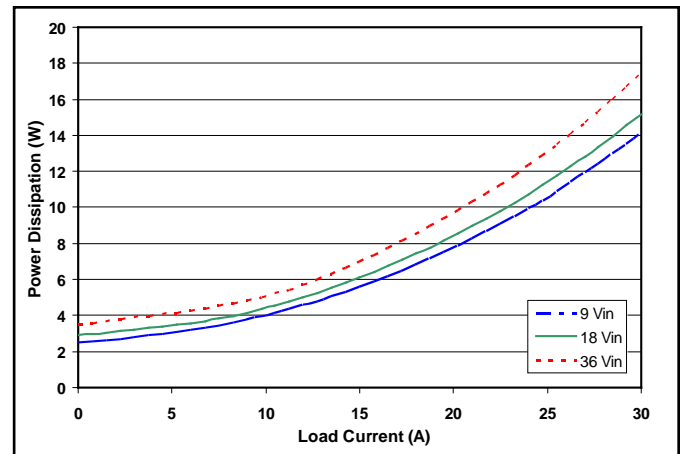


Figure 2: Power dissipation at nominal output voltage vs. load current for minimum, nominal, and maximum input voltage at 25°C.

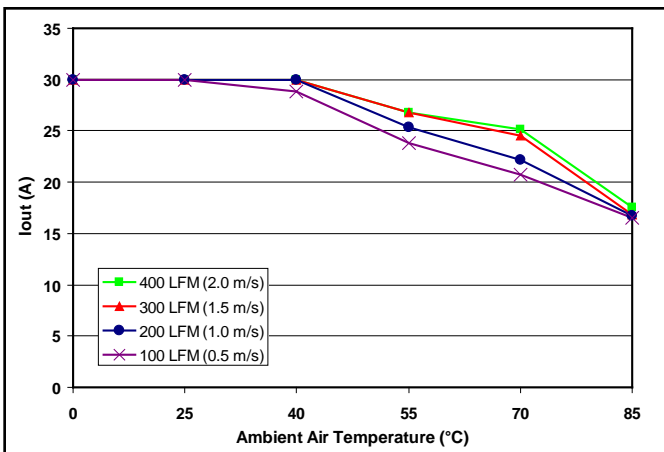


Figure 3: Encased converter (without heatsink) max. output power derating vs. ambient air temperature for airflow rates of 100 LFM through 400 LFM. Air flows across the converter from pin 3 to pin 1 (nominal input voltage).

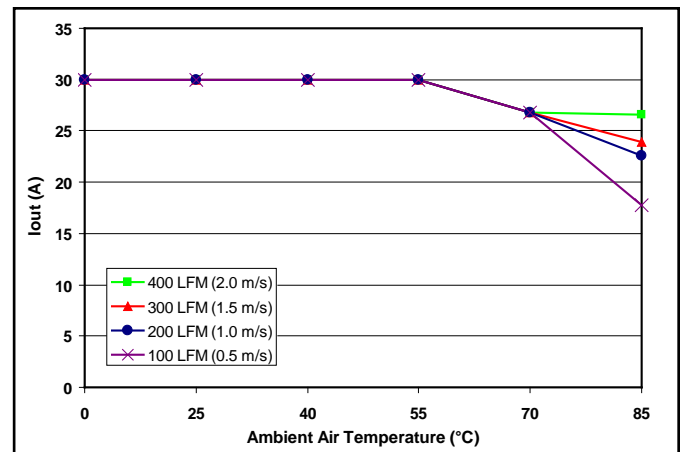


Figure 4: Encased converter (with 1/4" heatsink) max. output power derating vs. ambient air temperature for airflow rates of 100 LFM through 400 LFM. Air flows across the converter from pin 3 to pin 1 (nominal input voltage).

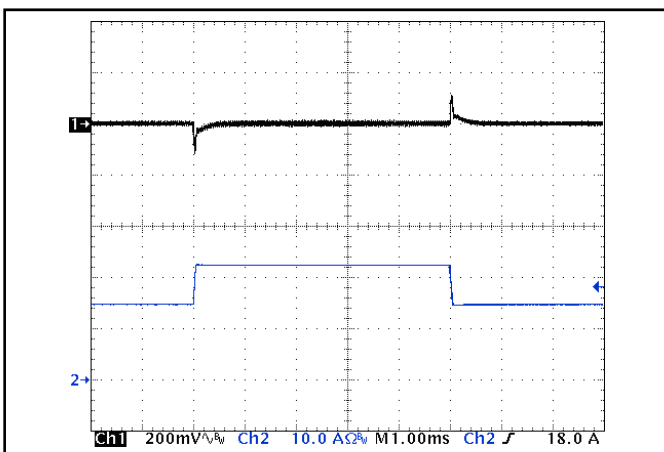


Figure 5: Output voltage response to step-change in load current (50%-75%-50% of I<sub>out</sub>(max); dl/dt = 0.2 A/μs). Load cap: 1 μF ceramic and 15 μF tantalum capacitors. Ch 1: V<sub>out</sub> (200 mV/div), Ch 2: I<sub>out</sub> (10 A/div).

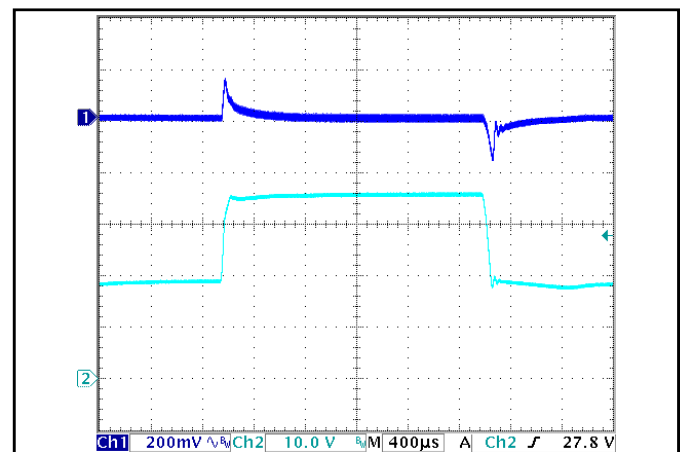


Figure 6: Output voltage response to step-change in input voltage (300 V/ms). Load cap: 100 μF, electrolytic output capacitance. Ch 1: V<sub>out</sub> (200 mV/div), Ch 2: V<sub>in</sub> (10 V/div).

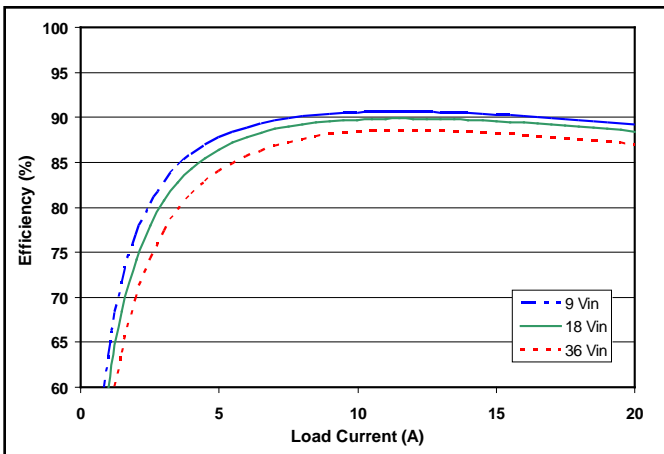
## IQ18050QTC20 ELECTRICAL CHARACTERISTICS (5.0 V<sub>OUT</sub>)

T<sub>A</sub> = 25 °C, airflow rate = 300 LFM, V<sub>IN</sub> = 18 V<sub>DC</sub> unless otherwise noted; full operating temperature range is -40 °C to +100 °C ambient temperature with appropriate power derating. Specifications subject to change without notice.

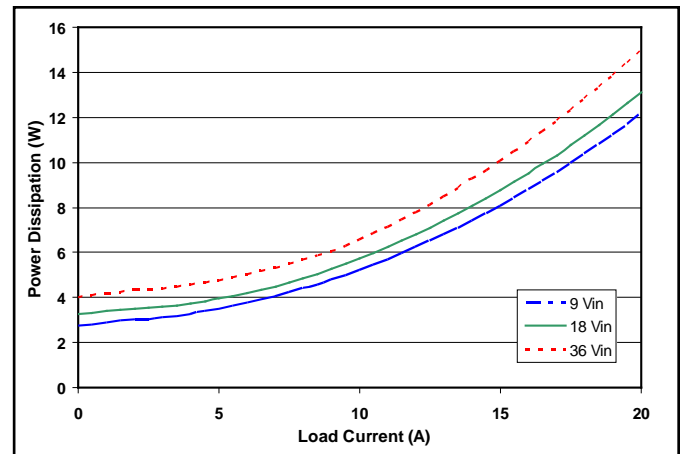
Parameter	Min.	Typ.	Max.	Units	Notes & Conditions
<b>INPUT CHARACTERISTICS</b>					
Maximum Input Current			16.6	A	9 V <sub>IN</sub> ; trim up; in current limit
No-Load Input Current		184	230	mA	
Disabled Input Current		2.6	4.0	mA	
Response to Input Transient		0.2		V	300 V/ms input transient; 100 μF output cap.
Input Terminal Ripple Current		370		mA	RMS
Recommended Input Fuse			30	A	Fast acting external fuse recommended
Input Filter Component Values (L\C)		0.47\18		μH\μF	Internal values; see Figure E
<b>OUTPUT CHARACTERISTICS</b>					
Output Voltage Set Point	4.95	5.00	5.05	V	
Output Voltage Regulation					
Over Line		+0.1	+0.3	%	
Over Load		+0.1	+0.3	%	
Over Temperature			75	mV	
Total Output Voltage Range	4.875		5.125	V	Over sample, line, load, temperature & life
Output Voltage Ripple and Noise <sup>1</sup>					20 MHz bandwidth
Peak-to-Peak		68	140	mV	Full Load
RMS		10	20	mV	Full Load
Operating Output Current Range	0		20	A	Subject to thermal derating
Output DC Current-Limit Inception	22	24	26	A	Output Voltage 10% Low
Output DC Current-Limit Shutdown Voltage		2.3		V	
Back-Drive Current Limit while Enabled		0.6		A	Negative current drawn from output
Back-Drive Current Limit while Disabled	0	15	50	mA	Negative current drawn from output
Maximum Output Capacitance			8,000	μF	V <sub>out</sub> nominal at full load (resistive load)
Output Voltage during Load Current Transient					
For a Step Change in Output Current (0.1 A/μs)		120		mV	50% to 75% to 50% I <sub>OUT</sub> max
Settling Time		100		μs	To within 1% V <sub>OUT</sub> nom
Output Voltage Trim Range	-20		+10	%	Measured across Pins 8 & 4; Common Figure 3
Output Voltage Remote Sense Range			+10	%	Measured across Pins 8 & 4
Output Over-Voltage Protection	117	122	127	%	Over full temp range; % of nominal V <sub>OUT</sub>
Load Current Scale Factor		1000			See Output Load Current app. note on our web
<b>EFFICIENCY</b>					
100% Load		88		%	See Figure 1 for efficiency curve
50% Load		90		%	See Figure 1 for efficiency curve

**Note 1:** Output is terminated with 1 μF ceramic and 15 μF low-ESR tantalum capacitors.

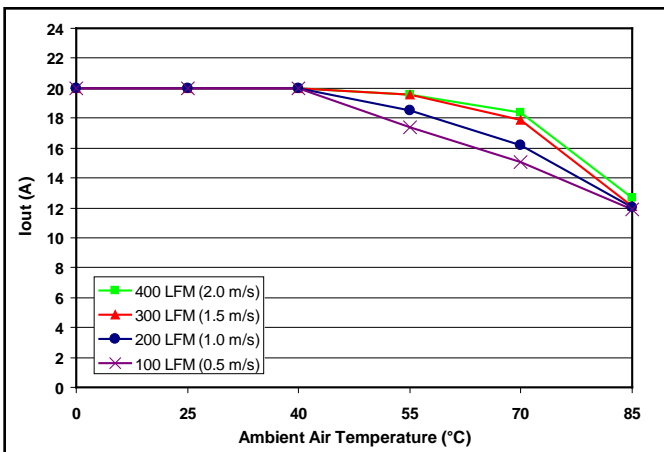
For applications requiring reduced output voltage ripple and noise, consult SynQor applications support (e-mail: support@synqor.com)



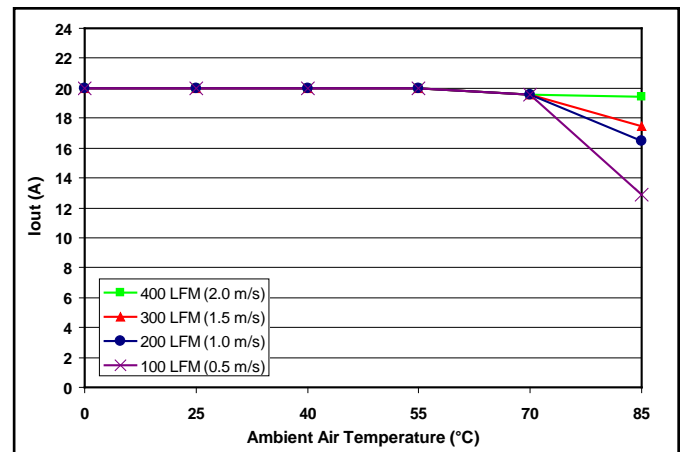
**Figure 1:** Efficiency at nominal output voltage vs. load current for minimum, nominal, and maximum input voltage at 25°C.



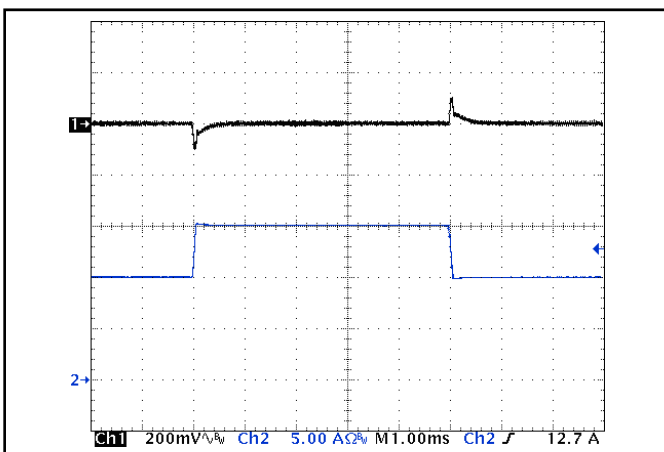
**Figure 2:** Power dissipation at nominal output voltage vs. load current for minimum, nominal, and maximum input voltage at 25°C.



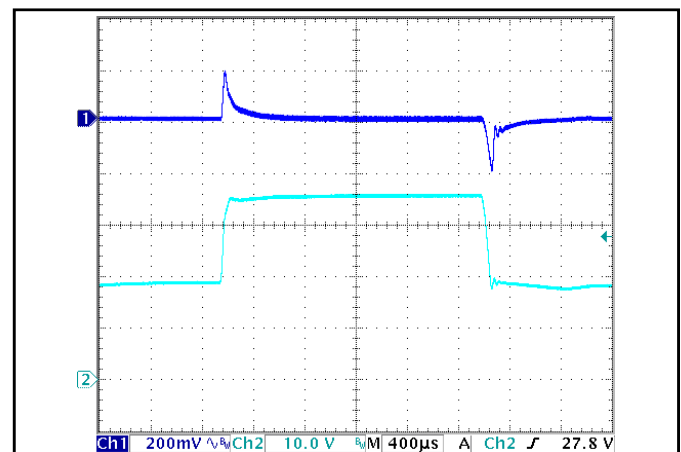
**Figure 3:** Encased converter (without heatsink) max. output power derating vs. ambient air temperature for airflow rates of 100 LFM through 400 LFM. Air flows across the converter from pin 3 to pin 1 (nominal input voltage).



**Figure 4:** Encased converter (with 1/4" heatsink) max. output power derating vs. ambient air temperature for airflow rates of 100 LFM through 400 LFM. Air flows across the converter from pin 3 to pin 1 (nominal input voltage).



**Figure 5:** Output voltage response to step-change in load current (50%-75%-50% of  $I_{out(max)}$ ;  $dI/dt = 0.1 A/\mu s$ ). Load cap: 1  $\mu F$  ceramic and 15  $\mu F$  tantalum capacitors. Ch 1:  $V_{out}$  (200 mV/div), Ch 2:  $I_{out}$  (5 A/div).



**Figure 6:** Output voltage response to step-change in input voltage (300 V/ms). Load cap: 100  $\mu F$ , electrolytic output capacitance. Ch 1:  $V_{out}$  (200 mV/div), Ch 2:  $V_{in}$  (10 V/div).

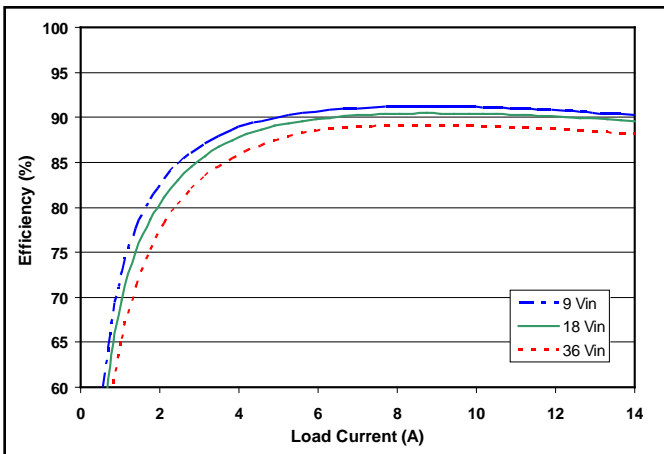
## IQ18070QTC14 ELECTRICAL CHARACTERISTICS (7.0 V<sub>OUT</sub>)

T<sub>A</sub> = 25 °C, airflow rate = 300 LFM, V<sub>IN</sub> = 18 V<sub>DC</sub> unless otherwise noted; full operating temperature range is -40 °C to +100 °C ambient temperature with appropriate power derating. Specifications subject to change without notice.

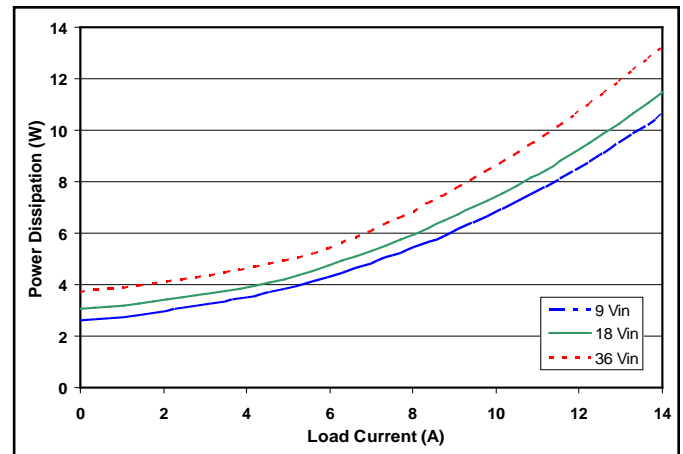
Parameter	Min.	Typ.	Max.	Units	Notes & Conditions
<b>INPUT CHARACTERISTICS</b>					
Maximum Input Current			16.1	A	9 V <sub>IN</sub> ; trim up; in current limit
No-Load Input Current		189	240	mA	
Disabled Input Current		2.6	4.0	mA	
Response to Input Transient		0.26		V	300 V/ms input transient; 100 μF output cap.
Input Terminal Ripple Current		360		mA	RMS
Recommended Input Fuse			30	A	Fast acting external fuse recommended
Input Filter Component Values (L\C)		0.47\18		μH\μF	Internal values; see Figure E
<b>OUTPUT CHARACTERISTICS</b>					
Output Voltage Set Point	6.930	7.000	7.070	V	
Output Voltage Regulation					
Over Line		+0.1	+0.3	%	
Over Load		+0.1	+0.3	%	
Over Temperature	-105		105	mV	
Total Output Voltage Range	6.825		7.175	V	Over sample, line, load, temperature & life
Output Voltage Ripple and Noise <sup>1</sup>					20 MHz bandwidth
Peak-to-Peak		48	100	mV	Full Load
RMS		8	20	mV	Full Load
Operating Output Current Range	0		14.0	A	Subject to thermal derating
Output DC Current-Limit Inception	15.4	16.8	18.2	A	Output Voltage 10% Low
Output DC Current-Limit Shutdown Voltage		5.0		V	
Back-Drive Current Limit while Enabled		0.5		A	Negative current drawn from output
Back-Drive Current Limit while Disabled	0	15	50	mA	Negative current drawn from output
Maximum Output Capacitance			4,000	μF	V <sub>out</sub> nominal at full load (resistive load)
Output Voltage during Load Current Transient					
For a Step Change in Output Current (0.1 A/μs)		200		mV	50% to 75% to 50% I <sub>OUT</sub> max
Settling Time		50		μs	To within 1% V <sub>OUT</sub> nom
Output Voltage Trim Range	-20		+10	%	Measured across Pins 8 & 4; Common Figure 3
Output Voltage Remote Sense Range			+10	%	Measured across Pins 8 & 4
Output Over-Voltage Protection	117	122	127	%	Over full temp range; % of nominal V <sub>OUT</sub>
Load Current Scale Factor		667			See Output Load Current app. note on our web
<b>EFFICIENCY</b>					
100% Load		90		%	See Figure 1 for efficiency curve
50% Load		90		%	See Figure 1 for efficiency curve

**Note 1:** Output is terminated with 1 μF ceramic and 15 μF low-ESR tantalum capacitors.

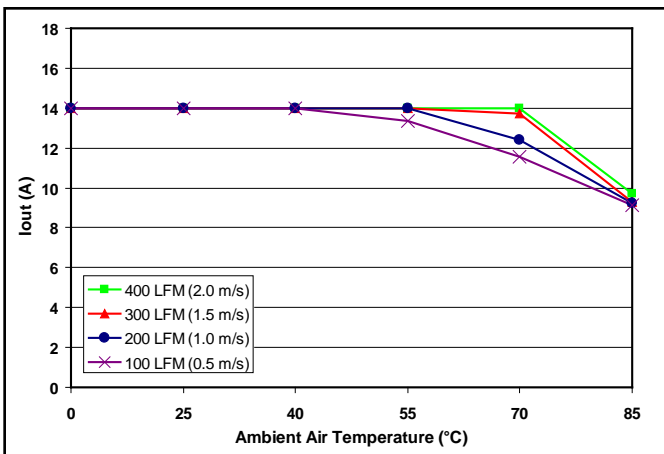
For applications requiring reduced output voltage ripple and noise, consult SynQor applications support (e-mail: support@synqor.com)



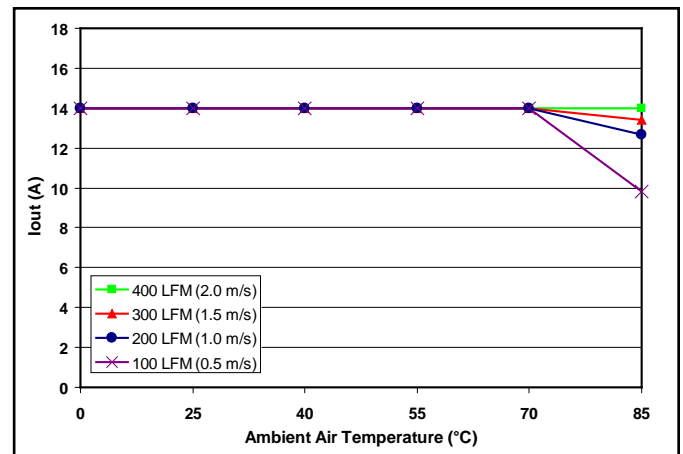
**Figure 1:** Efficiency at nominal output voltage vs. load current for minimum, nominal, and maximum input voltage at 25°C.



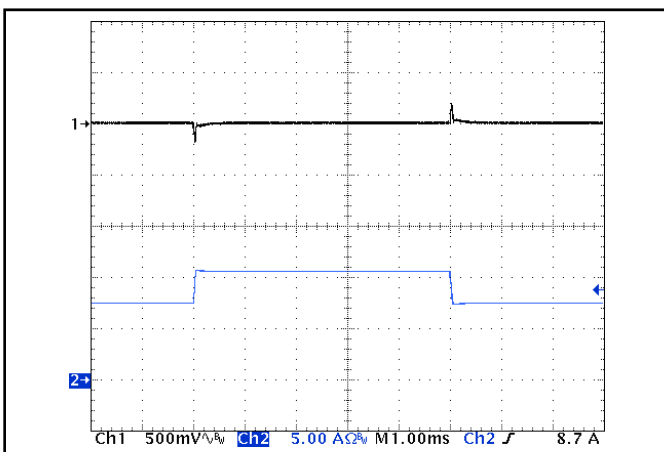
**Figure 2:** Power dissipation at nominal output voltage vs. load current for minimum, nominal, and maximum input voltage at 25°C.



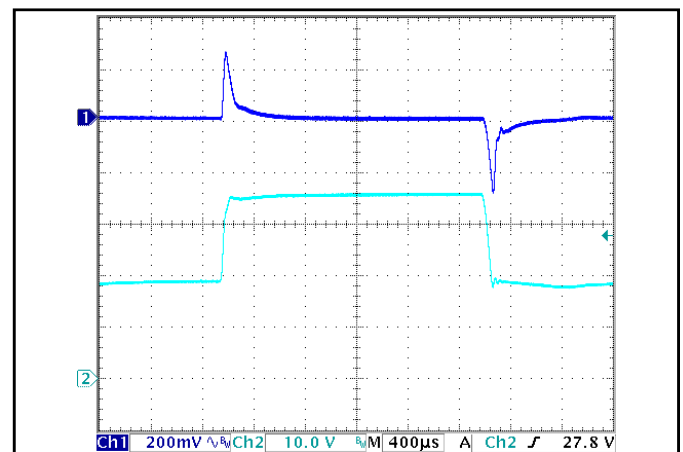
**Figure 3:** Encased converter (without heatsink) max. output power derating vs. ambient air temperature for airflow rates of 100 LFM through 400 LFM. Air flows across the converter from pin 3 to pin 1 (nominal input voltage).



**Figure 4:** Encased converter (with 1/4" heatsink) max. output power derating vs. ambient air temperature for airflow rates of 100 LFM through 400 LFM. Air flows across the converter from pin 3 to pin 1 (nominal input voltage).



**Figure 5:** Output voltage response to step-change in load current (50%-75%-50% of I<sub>out</sub>(max); dl/dt = 0.1 A/μs). Load cap: 1 μF ceramic and 15 μF tantalum capacitors. Ch 1: V<sub>out</sub> (500 mV/div), Ch 2: I<sub>out</sub> (5 A/div).



**Figure 6:** Output voltage response to step-change in input voltage (300 V/ms). Load cap: 100 μF, electrolytic output capacitance. Ch 1: V<sub>out</sub> (200 mV/div), Ch 2: V<sub>in</sub> (10 V/div).

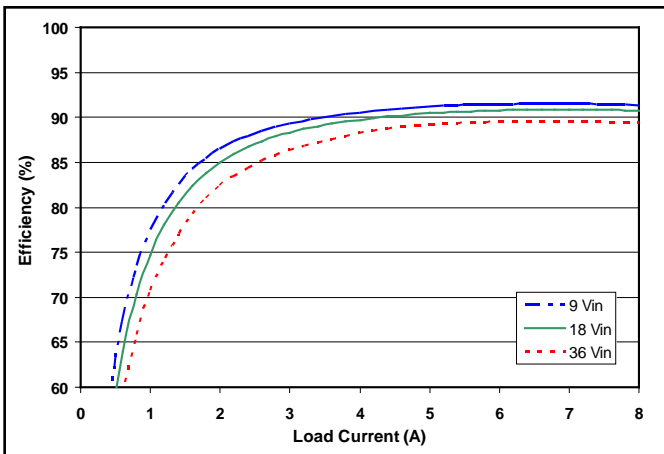
## IQ18120QTC08 ELECTRICAL CHARACTERISTICS (12 V<sub>OUT</sub>)

T<sub>A</sub> = 25 °C, airflow rate = 300 LFM, V<sub>IN</sub> = 18 V<sub>DC</sub> unless otherwise noted; full operating temperature range is -40 °C to +100 °C ambient temperature with appropriate power derating. Specifications subject to change without notice.

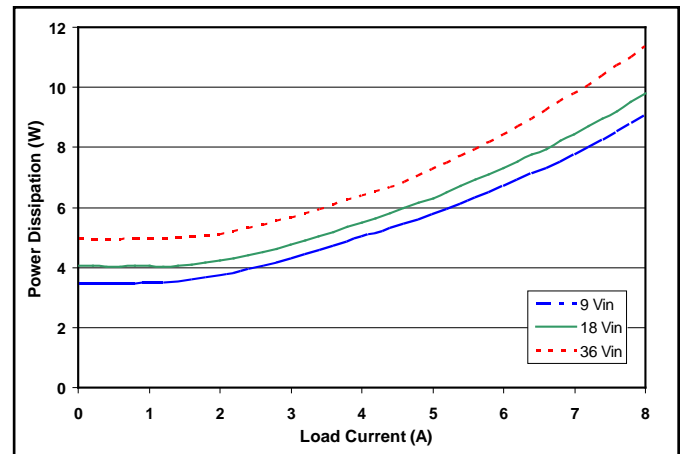
Parameter	Min.	Typ.	Max.	Units	Notes & Conditions
<b>INPUT CHARACTERISTICS</b>					
Maximum Input Current			14.1	A	9 V <sub>IN</sub> ; 12 V <sub>OUT</sub> ; in current limit
No-Load Input Current		237	300	mA	
Disabled Input Current		2.7	4.0	mA	
Response to Input Transient		0.4		V	300 V/ms input transient; 100 μF output cap.
Input Terminal Ripple Current		360		mA	RMS
Recommended Input Fuse			30	A	Fast acting external fuse recommended
Input Filter Component Values (L\C)		0.47\18		μH\μF	Internal values; see Figure E
<b>OUTPUT CHARACTERISTICS</b>					
Output Voltage Set Point	11.88	12.00	12.12	V	
Output Voltage Regulation					
Over Line		+0.1	+0.3	%	
Over Load		+0.1	+0.3	%	
Over Temperature	-180		180	mV	
Total Output Voltage Range	11.7		12.3	V	Over sample, line, load, temperature & life
Output Voltage Ripple and Noise <sup>1</sup>					20 MHz bandwidth
Peak-to-Peak		44	90	mV	Full Load
RMS		8	20	mV	Full Load
Operating Output Current Range	0		8	A	Subject to thermal derating
Output DC Current-Limit Inception	8.8	9.6	10.4	A	Output Voltage 10% Low
Output DC Current-Limit Shutdown Voltage		10.0		V	
Back-Drive Current Limit while Enabled		0.4		A	Negative current drawn from output
Back-Drive Current Limit while Disabled	0	15	50	mA	Negative current drawn from output
Maximum Output Capacitance			1500	μF	V <sub>OUT</sub> nominal at full load (resistive load)
Output Voltage during Load Current Transient					
For a Step Change in Output Current (0.1 A/μs)		470		mV	50% to 75% to 50% I <sub>OUT</sub> max
Settling Time		50		μs	To within 1% V <sub>OUT</sub> nom
Output Voltage Trim Range	-20		+10	%	Measured across Pins 8 & 4; Common Figure 3
Output Voltage Remote Sense Range			+10	%	Measured across Pins 8 & 4
Output Over-Voltage Protection	117	122	127	%	Over full temp range; % of nominal V <sub>OUT</sub>
Load Current Scale Factor		444			See Output Load Current app. note on our web
<b>EFFICIENCY</b>					
100% Load		91		%	See Figure 1 for efficiency curve
50% Load		90		%	See Figure 1 for efficiency curve

**Note 1:** Output is terminated with 1 μF ceramic and 15 μF low-ESR tantalum capacitors.

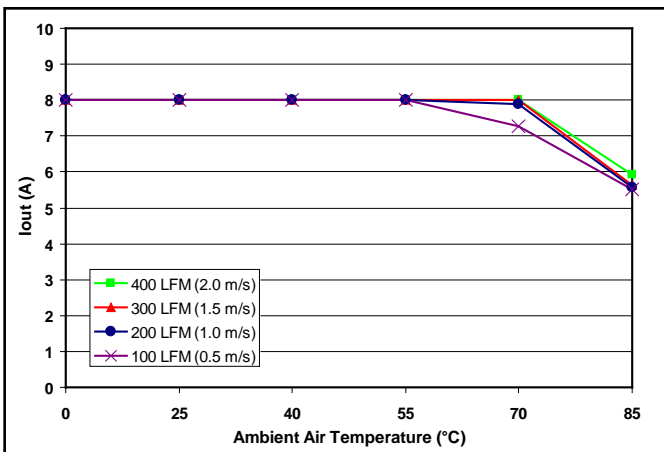
For applications requiring reduced output voltage ripple and noise, consult SynQor applications support (e-mail: support@synqor.com)



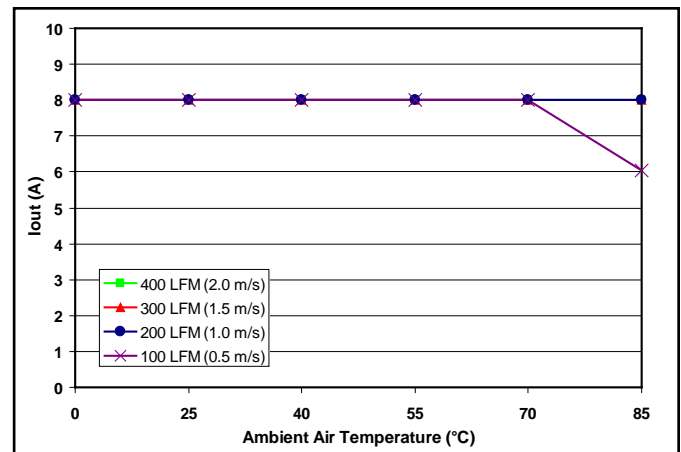
**Figure 1:** Efficiency at nominal output voltage vs. load current for minimum, nominal, and maximum input voltage at 25°C.



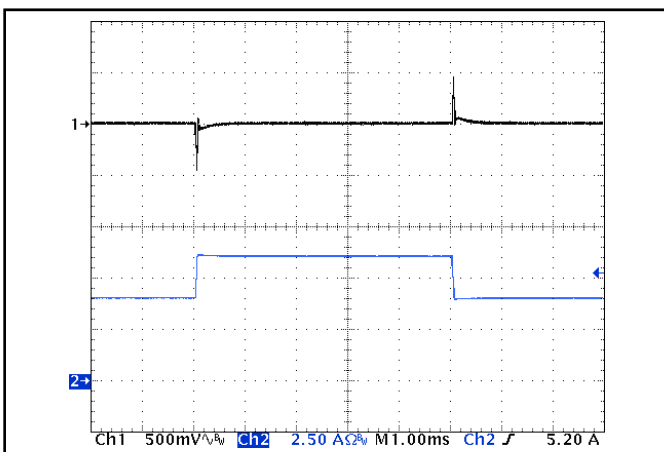
**Figure 2:** Power dissipation at nominal output voltage vs. load current for minimum, nominal, and maximum input voltage at 25°C.



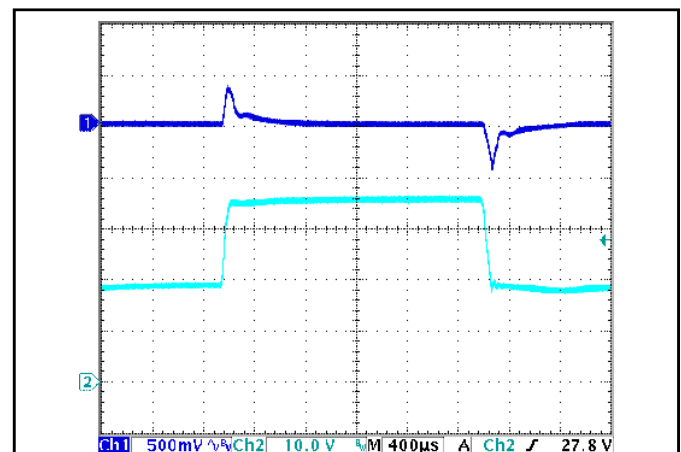
**Figure 3:** Encased converter (without heatsink) max. output power derating vs. ambient air temperature for airflow rates of 100 LFM through 400 LFM. Air flows across the converter from pin 3 to pin 1 (nominal input voltage).



**Figure 4:** Encased converter (with 1/4" heatsink) max. output power derating vs. ambient air temperature for airflow rates of 100 LFM through 400 LFM. Air flows across the converter from pin 3 to pin 1 (nominal input voltage).



**Figure 5:** Output voltage response to step-change in load current (50%-75%-50% of I<sub>out</sub>(max); dl/dt = 0.1 A/μs). Load cap: 1 μF ceramic and 15 μF tantalum capacitors. Ch 1: V<sub>out</sub> (500 mV/div), Ch 2: I<sub>out</sub> (2.5 A/div).



**Figure 6:** Output voltage response to step-change in input voltage (300 V/ms). Load cap: 100 μF, electrolytic output capacitance. Ch 1: V<sub>out</sub> (500 mV/div), Ch 2: V<sub>in</sub> (10 V/div).

## IQ18150QTC07 ELECTRICAL CHARACTERISTICS (15 V<sub>OUT</sub>)

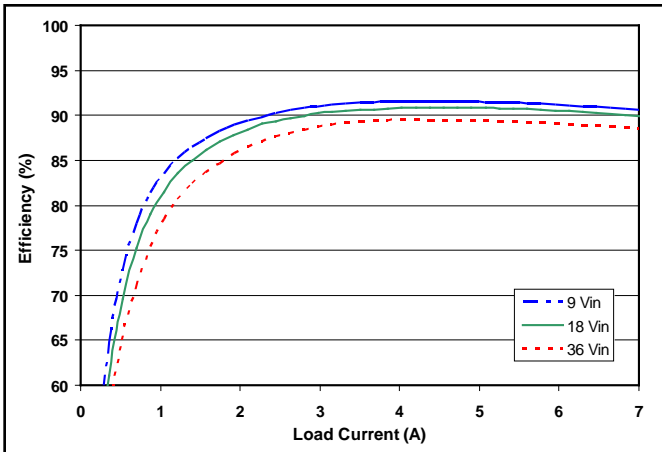
T<sub>A</sub> = 25 °C, airflow rate = 300 LFM, V<sub>IN</sub> = 18 V<sub>DC</sub> unless otherwise noted; full operating temperature range is -40 °C to +100 °C ambient temperature with appropriate power derating. Specifications subject to change without notice.

Parameter	Min.	Typ.	Max.	Units	Notes & Conditions
<b>INPUT CHARACTERISTICS</b>					
Maximum Input Current			17.1	A	18 V <sub>IN</sub> ; trim up; in current limit
No-Load Input Current		205	260	mA	
Disabled Input Current		2.8	4.0	mA	
Response to Input Transient		0.45		V	300 V/ms input transient; 100 μF output cap.
Input Terminal Ripple Current		375		mA	RMS
Recommended Input Fuse			30	A	Fast acting external fuse recommended
Input Filter Component Values (L\C)		0.47\18		μH\μF	Internal values; see Figure E
<b>OUTPUT CHARACTERISTICS</b>					
Output Voltage Set Point	14.85	15.00	15.15	V	
Output Voltage Regulation					
Over Line		+0.1	+0.3	%	
Over Load		+0.1	+0.3	%	
Over Temperature	-225		225	mV	
Total Output Voltage Range	14.625		15.375	V	Over sample, line, load, temperature & life
Output Voltage Ripple and Noise <sup>1</sup>					20 MHz bandwidth
Peak-to-Peak		66	130	mV	Full Load
RMS		12	20	mV	Full Load
Operating Output Current Range	0		7.0	A	Subject to thermal derating
Output DC Current-Limit Inception	7.7	8.4	9.1	A	Output Voltage 10% Low
Output DC Current-Limit Shutdown Voltage		10.7		V	
Back-Drive Current Limit while Enabled		0.3		A	Negative current drawn from output
Back-Drive Current Limit while Disabled	0	15	50	mA	Negative current drawn from output
Maximum Output Capacitance			1000	μF	V <sub>out</sub> nominal at full load (resistive load)
Output Voltage during Load Current Transient					
For a Step Change in Output Current (0.1 A/μs)		800		mV	50% to 75% to 50% I <sub>OUT</sub> max
Settling Time		50		μs	To within 1% V <sub>OUT</sub> nom
Output Voltage Trim Range	-20		+10	%	Measured across Pins 8 & 4; Common Figure 3
Output Voltage Remote Sense Range			+10	%	Measured across Pins 8 & 4
Output Over-Voltage Protection	117	122	127	%	Over full temp range; % of nominal V <sub>OUT</sub>
Load Current Scale Factor		333			See Output Load Current app. note on our web
<b>EFFICIENCY</b>					
100% Load		90		%	See Figure 1 for efficiency curve
50% Load		91		%	See Figure 1 for efficiency curve

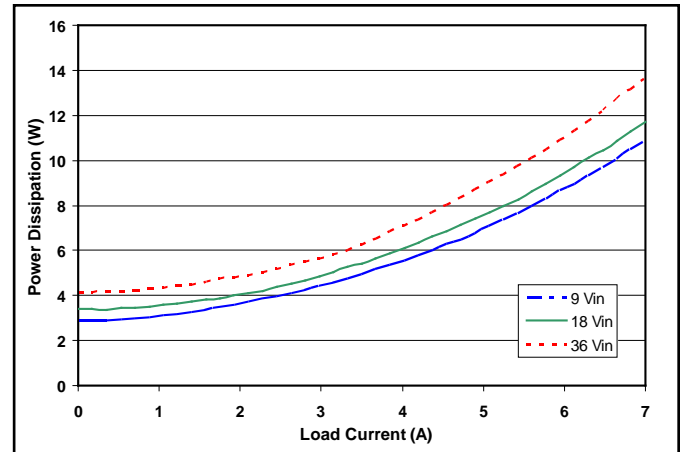
**Note 1:** Output is terminated with 1 μF ceramic and 15 μF low-ESR tantalum capacitors.

For applications requiring reduced output voltage ripple and noise, consult SynQor applications support (e-mail: support@synqor.com)

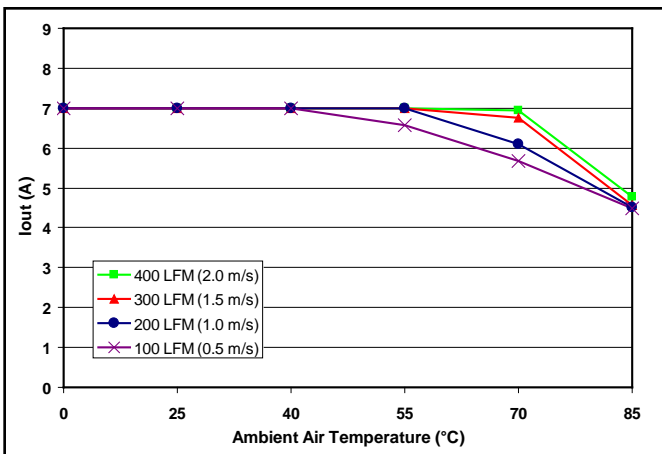




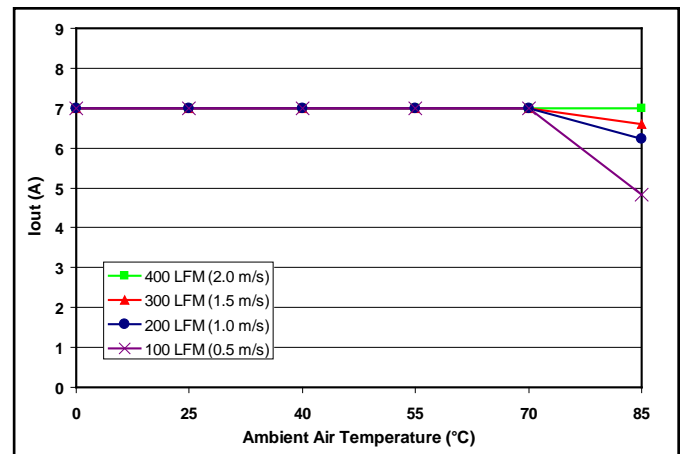
**Figure 1:** Efficiency at nominal output voltage vs. load current for minimum, nominal, and maximum input voltage at 25°C.



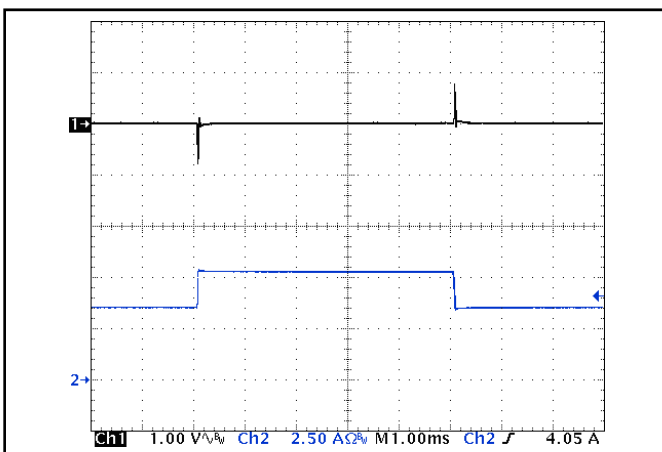
**Figure 2:** Power dissipation at nominal output voltage vs. load current for minimum, nominal, and maximum input voltage at 25°C.



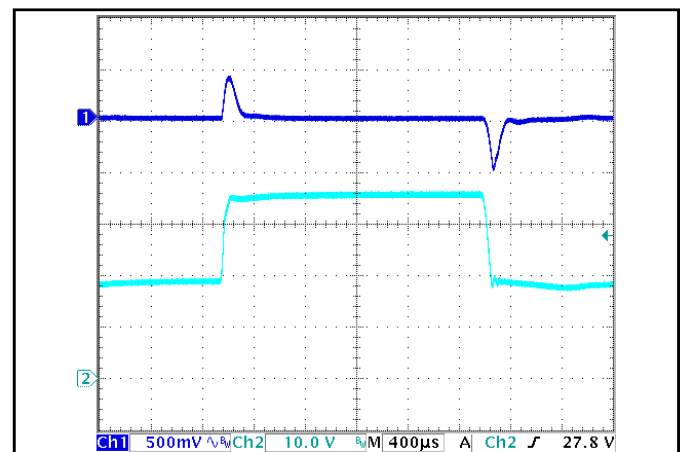
**Figure 3:** Encased converter (without heatsink) max. output power derating vs. ambient air temperature for airflow rates of 100 LFM through 400 LFM. Air flows across the converter from pin 3 to pin 1 (nominal input voltage).



**Figure 4:** Encased converter (with 1/4" heatsink) max. output power derating vs. ambient air temperature for airflow rates of 100 LFM through 400 LFM. Air flows across the converter from pin 3 to pin 1 (nominal input voltage).



**Figure 5:** Output voltage response to step-change in load current (50%-75%-50% of I<sub>out</sub>(max); dl/dt = 0.1 A/μs). Load cap: 1 μF ceramic and 15 μF tantalum capacitors. Ch 1: V<sub>out</sub> (1 V/div), Ch 2: I<sub>out</sub> (2.5 A/div).



**Figure 6:** Output voltage response to step-change in input voltage (300 V/ms). Load cap: 100 μF, electrolytic output capacitance. Ch 1: V<sub>out</sub> (500 mV/div), Ch 2: V<sub>in</sub> (10 V/div).

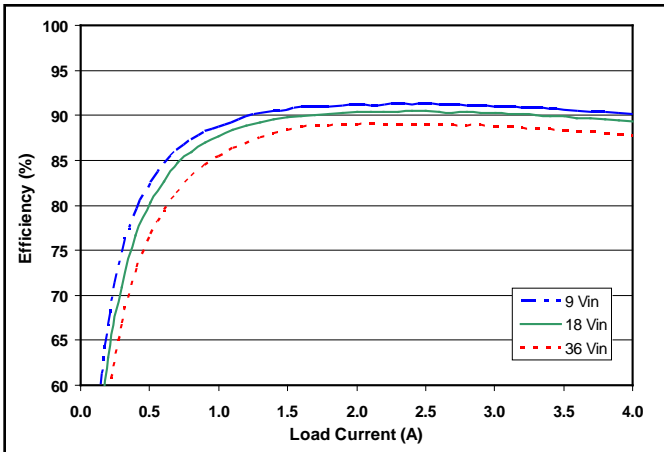
## IQ18240QTC04 ELECTRICAL CHARACTERISTICS (24 V<sub>OUT</sub>)

T<sub>A</sub> = 25 °C, airflow rate = 300 LFM, V<sub>IN</sub> = 18 V<sub>DC</sub> unless otherwise noted; full operating temperature range is -40 °C to +100 °C ambient temperature with appropriate power derating. Specifications subject to change without notice.

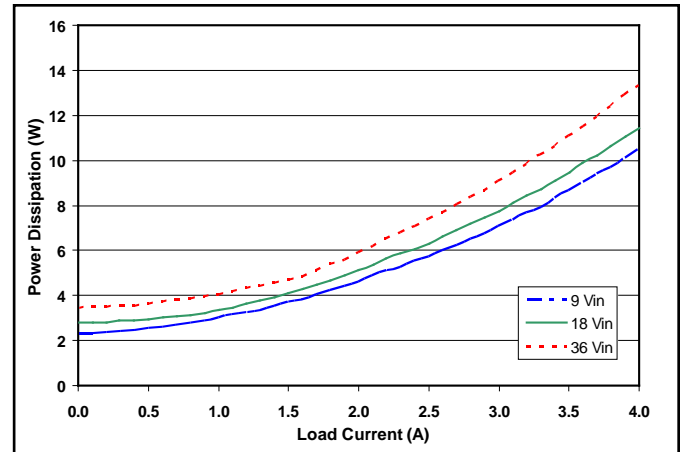
Parameter	Min.	Typ.	Max.	Units	Notes & Conditions
<b>INPUT CHARACTERISTICS</b>					
Maximum Input Current			15.7	A	9 V <sub>IN</sub> ; trim up; in current limit
No-Load Input Current		173	220	mA	
Disabled Input Current		2.8	4.0	mA	
Response to Input Transient		0.7		V	300 V/ms input transient; 100 μF output cap.
Input Terminal Ripple Current		350		mA	RMS
Recommended Input Fuse			30	A	Fast acting external fuse recommended
Input Filter Component Values (L\C)		0.47\18		μH\μF	Internal values; see Figure E
<b>OUTPUT CHARACTERISTICS</b>					
Output Voltage Set Point	23.76	24.00	24.24	V	
Output Voltage Regulation					
Over Line		+0.1	+0.3	%	
Over Load		+0.1	+0.3	%	
Over Temperature	-360		360	mV	
Total Output Voltage Range	23.4		24.6	V	Over sample, line, load, temperature & life
Output Voltage Ripple and Noise <sup>1</sup>					20 MHz bandwidth
Peak-to-Peak		44	90	mV	Full Load
RMS		11	20	mV	Full Load
Operating Output Current Range	0		4.0	A	Subject to thermal derating
Output DC Current-Limit Inception	4.4	4.8	5.2	A	Output Voltage 10% Low
Output DC Current-Limit Shutdown Voltage		14		V	
Back-Drive Current Limit while Enabled		0.14		A	Negative current drawn from output
Back-Drive Current Limit while Disabled	0	15	50	mA	Negative current drawn from output
Maximum Output Capacitance			400	μF	V <sub>out</sub> nominal at full load (resistive load)
Output Voltage during Load Current Transient					
For a Step Change in Output Current (0.1 A/μs)		1200		mV	50% to 75% to 50% I <sub>OUT</sub> max
Settling Time		100		μs	To within 1% V <sub>OUT</sub> nom
Output Voltage Trim Range	-20		+10	%	Measured across Pins 8 & 4; Common Figure 3
Output Voltage Remote Sense Range			+10	%	Measured across Pins 8 & 4
Output Over-Voltage Protection	117	122	127	%	Over full temp range; % of nominal V <sub>OUT</sub>
Load Current Scale Factor		190			See Output Load Current app. note on our web
<b>EFFICIENCY</b>					
100% Load		89		%	See Figure 1 for efficiency curve
50% Load		90		%	See Figure 1 for efficiency curve

**Note 1:** Output is terminated with 1 μF ceramic.

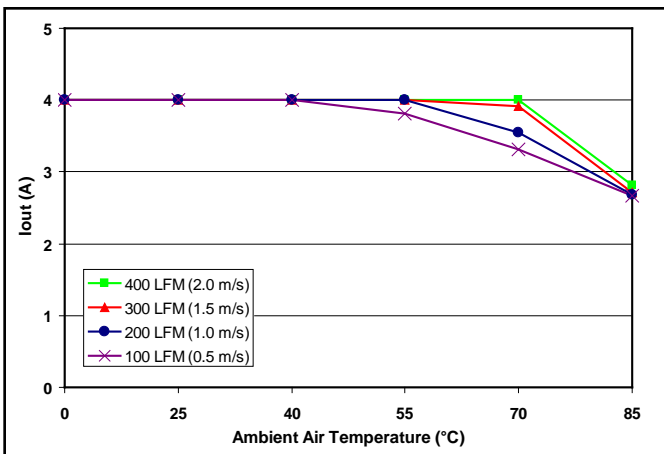
For applications requiring reduced output voltage ripple and noise, consult SynQor applications support (e-mail: support@synqor.com)



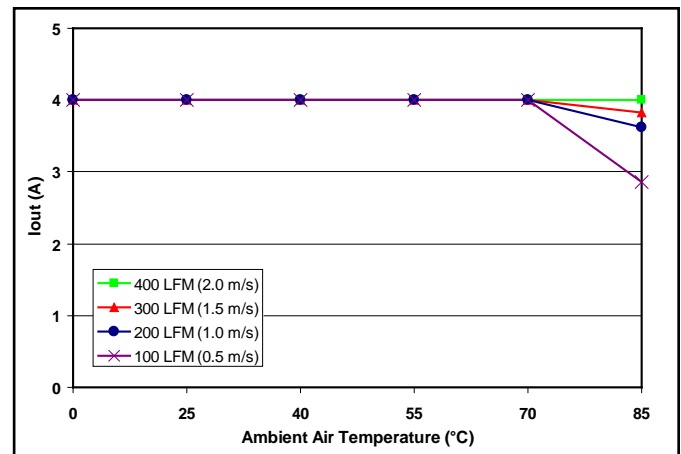
**Figure 1:** Efficiency at nominal output voltage vs. load current for minimum, nominal, and maximum input voltage at 25°C.



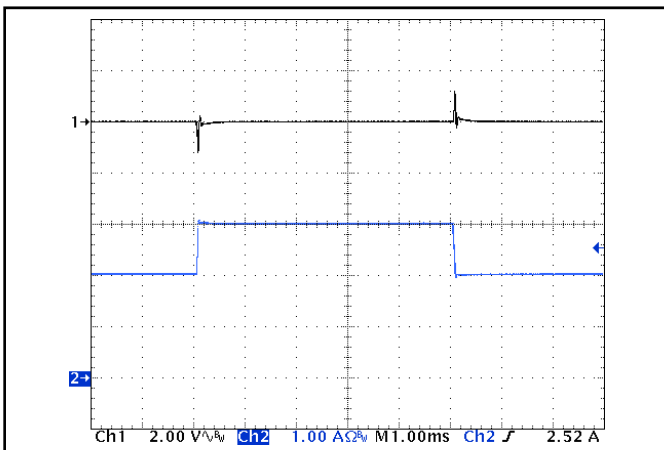
**Figure 2:** Power dissipation at nominal output voltage vs. load current for minimum, nominal, and maximum input voltage at 25°C.



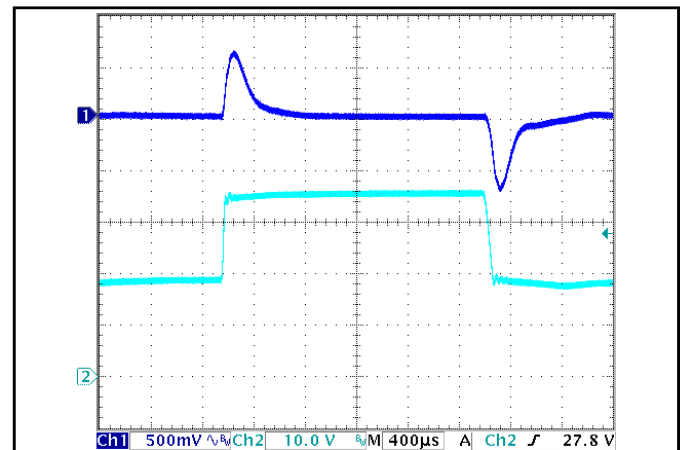
**Figure 3:** Encased converter (without heatsink) max. output power derating vs. ambient air temperature for airflow rates of 100 LFM through 400 LFM. Air flows across the converter from pin 3 to pin 1 (nominal input voltage).



**Figure 4:** Encased converter (with 1/4" heatsink) max. output power derating vs. ambient air temperature for airflow rates of 100 LFM through 400 LFM. Air flows across the converter from pin 3 to pin 1 (nominal input voltage).



**Figure 5:** Output voltage response to step-change in load current (50%-75%-50% of I<sub>out</sub>(max); dI/dt = 0.08 A/μs). Load cap: 1 μF ceramic capacitor. Ch 1: V<sub>out</sub> (2 V/div), Ch 2: I<sub>out</sub> (1 A/div).



**Figure 6:** Output voltage response to step-change in input voltage (300 V/ms). Load cap: 100 μF, electrolytic output capacitance. Ch 1: V<sub>out</sub> (500 mV/div), Ch 2: V<sub>in</sub> (10 V/div).

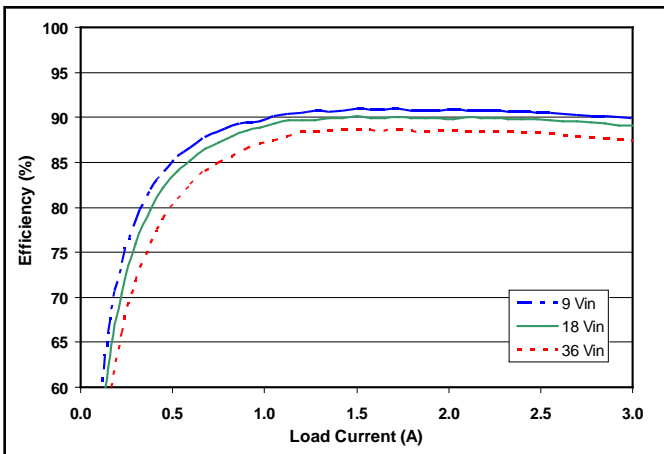
## IQ18300QTC03 ELECTRICAL CHARACTERISTICS (30 V<sub>OUT</sub>)

T<sub>A</sub> = 25 °C, airflow rate = 300 LFM, V<sub>IN</sub> = 18 V<sub>DC</sub> unless otherwise noted; full operating temperature range is -40 °C to +100 °C ambient temperature with appropriate power derating. Specifications subject to change without notice.

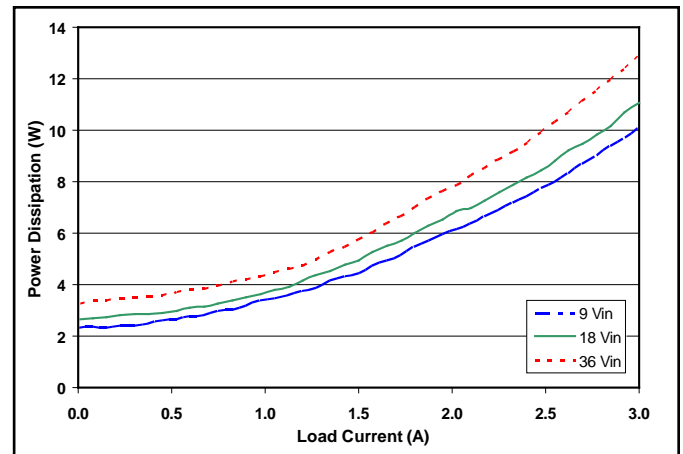
Parameter	Min.	Typ.	Max.	Units	Notes & Conditions
<b>INPUT CHARACTERISTICS</b>					
Maximum Input Current			14.8	A	9 V <sub>IN</sub> ; trim up; in current limit
No-Load Input Current		175	220	mA	
Disabled Input Current		2.5	4.0	mA	
Response to Input Transient		0.7		V	300 V/ms input transient; 100 μF output cap.
Input Terminal Ripple Current		340		mA	RMS
Recommended Input Fuse			30	A	Fast acting external fuse recommended
Input Filter Component Values (L\C)		0.47\18		μH\μF	Internal values; see Figure E
<b>OUTPUT CHARACTERISTICS</b>					
Output Voltage Set Point	29.7	30.0	30.3	V	
Output Voltage Regulation					
Over Line		+0.1	+0.3	%	
Over Load		+0.1	+0.3	%	
Over Temperature	-450		450	mV	
Total Output Voltage Range	29.25		30.75	V	Over sample, line, load, temperature & life
Output Voltage Ripple and Noise <sup>1</sup>					20 MHz bandwidth
Peak-to-Peak		46	90	mV	Full Load
RMS		10	20	mV	Full Load
Operating Output Current Range	0		3.0	A	Subject to thermal derating
Output DC Current-Limit Inception	3.3	3.6	3.9	A	Output Voltage 10% Low
Output DC Current-Limit Shutdown Voltage		18		V	
Back-Drive Current Limit while Enabled		0.11		A	Negative current drawn from output
Back-Drive Current Limit while Disabled	0	15	50	mA	Negative current drawn from output
Maximum Output Capacitance			250	μF	V <sub>out</sub> nominal at full load (resistive load)
Output Voltage during Load Current Transient					
For a Step Change in Output Current (0.1 A/μs)		1400		mV	50% to 75% to 50% I <sub>OUT</sub> max
Settling Time		100		μs	To within 1% V <sub>OUT</sub> nom
Output Voltage Trim Range	-20		+10	%	Measured across Pins 8 & 4; Common Figure 3
Output Voltage Remote Sense Range			+10	%	Measured across Pins 8 & 4
Output Over-Voltage Protection	117	122	127	%	Over full temp range; % of nominal V <sub>OUT</sub>
Load Current Scale Factor		148			See Output Load Current app. note on our web
<b>EFFICIENCY</b>					
100% Load		89		%	See Figure 1 for efficiency curve
50% Load		90		%	See Figure 1 for efficiency curve

**Note 1:** Output is terminated with 1 μF ceramic.

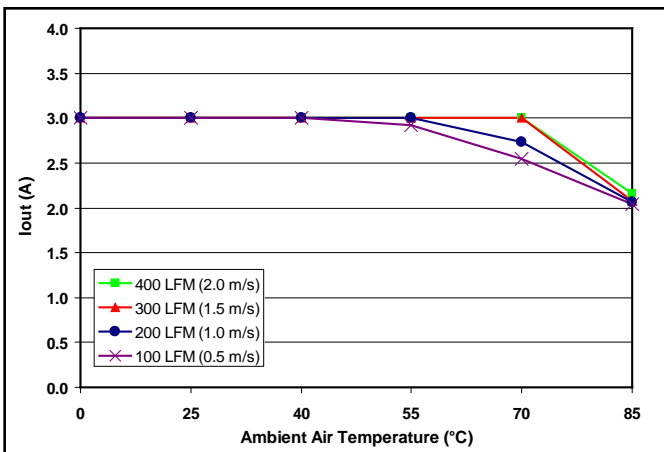
For applications requiring reduced output voltage ripple and noise, consult SynQor applications support (e-mail: support@synqor.com)



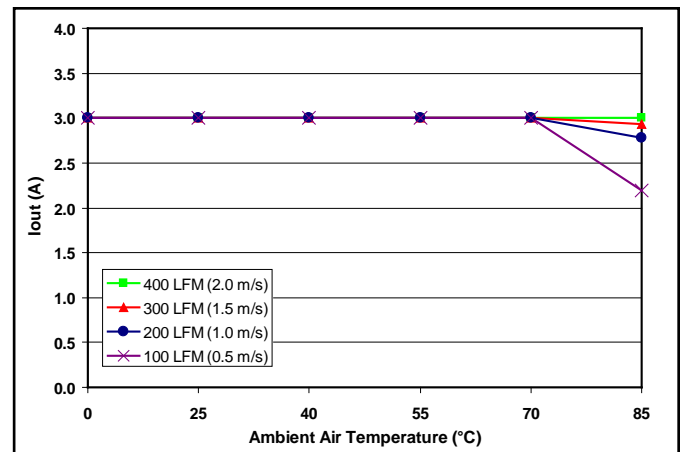
**Figure 1:** Efficiency at nominal output voltage vs. load current for minimum, nominal, and maximum input voltage at 25°C.



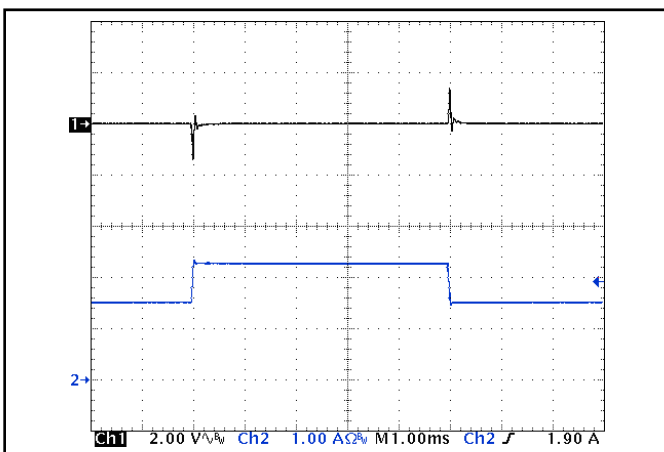
**Figure 2:** Power dissipation at nominal output voltage vs. load current for minimum, nominal, and maximum input voltage at 25°C.



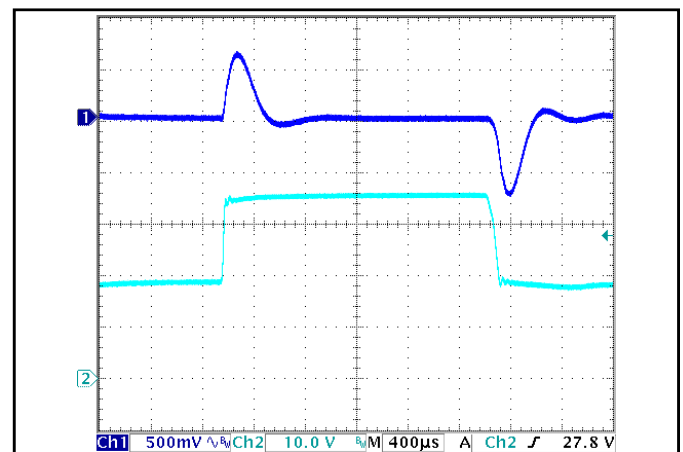
**Figure 3:** Encased converter (without heatsink) max. output power derating vs. ambient air temperature for airflow rates of 100 LFM through 400 LFM. Air flows across the converter from pin 3 to pin 1 (nominal input voltage).



**Figure 4:** Encased converter (with 1/4" heatsink) max. output power derating vs. ambient air temperature for airflow rates of 100 LFM through 400 LFM. Air flows across the converter from pin 3 to pin 1 (nominal input voltage).



**Figure 5:** Output voltage response to step-change in load current (50%-75%-50% of I<sub>out</sub>(max)); dI/dt = 0.05 A/μs. Load cap: 1 μF ceramic capacitor. Ch 1: V<sub>out</sub> (2 V/div), Ch 2: I<sub>out</sub> (1 A/div).



**Figure 6:** Output voltage response to step-change in input voltage (300 V/ms). Load cap: 100 μF, electrolytic output capacitance. Ch 1: V<sub>out</sub> (500 mV/div), Ch 2: V<sub>in</sub> (10 V/div).

## IQ18480QTC02 ELECTRICAL CHARACTERISTICS (48 V<sub>OUT</sub>)

T<sub>A</sub> = 25 °C, airflow rate = 300 LFM, V<sub>IN</sub> = 18 V<sub>DC</sub> unless otherwise noted; full operating temperature range is -40 °C to +100 °C ambient temperature with appropriate power derating. Specifications subject to change without notice.

Parameter	Min.	Typ.	Max.	Units	Notes & Conditions
<b>INPUT CHARACTERISTICS</b>					
Maximum Input Current			16.0	A	9 V <sub>IN</sub> ; trim up; in current limit
No-Load Input Current		165	210	mA	
Disabled Input Current		2.5	4.0	mA	
Response to Input Transient		0.8		V	300 V/ms input transient; 100 μF output cap.
Input Terminal Ripple Current		380		mA	RMS
Recommended Input Fuse			30	A	Fast acting external fuse recommended
Input Filter Component Values (L\C)		0.47\18		μH\μF	Internal values; see Figure E
<b>OUTPUT CHARACTERISTICS</b>					
Output Voltage Set Point	47.52	48.0	48.48	V	
Output Voltage Regulation					
Over Line		+0.1	+0.3	%	
Over Load		+0.1	+0.3	%	
Over Temperature	-720		720	mV	
Total Output Voltage Range	46.80		49.20	V	Over sample, line, load, temperature & life
Output Voltage Ripple and Noise <sup>1</sup>					20 MHz bandwidth
Peak-to-Peak		66	150	mV	Full Load
RMS		19	40	mV	Full Load
Operating Output Current Range	0		2	A	Subject to thermal derating
Output DC Current-Limit Inception	2.2	2.4	2.6	A	Output Voltage 10% Low
Output DC Current-Limit Shutdown Voltage		30		V	
Back-Drive Current Limit while Enabled		0.05		A	Negative current drawn from output
Back-Drive Current Limit while Disabled	0	15	50	mA	Negative current drawn from output
Maximum Output Capacitance			100	μF	V <sub>out</sub> nominal at full load (resistive load)
Output Voltage during Load Current Transient					
For a Step Change in Output Current (0.1 A/μs)		3000		mV	50% to 75% to 50% I <sub>OUT</sub> max
Settling Time		100		μs	To within 1% V <sub>OUT</sub> nom
Output Voltage Trim Range	-20		+10	%	Measured across Pins 8 & 4; Common Figure 3
Output Voltage Remote Sense Range			+10	%	Measured across Pins 8 & 4
Output Over-Voltage Protection	115	120	124	%	Over full temp range; % of nominal V <sub>OUT</sub>
Load Current Scale Factor		89			See Output Load Current app. note on our web
<b>EFFICIENCY</b>					
100% Load		88		%	See Figure 1 for efficiency curve
50% Load		90		%	See Figure 1 for efficiency curve

**Note 1:** Output is terminated with 1 μF ceramic.

For applications requiring reduced output voltage ripple and noise, consult SynQor applications support (e-mail: support@synqor.com)

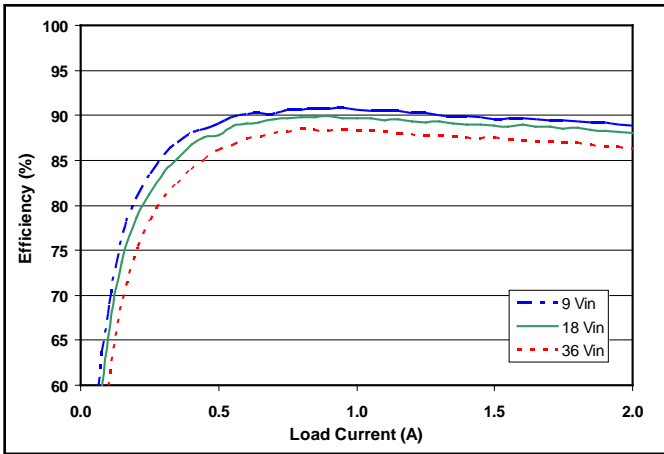


Figure 1: Efficiency at nominal output voltage vs. load current for minimum, nominal, and maximum input voltage at 25°C.

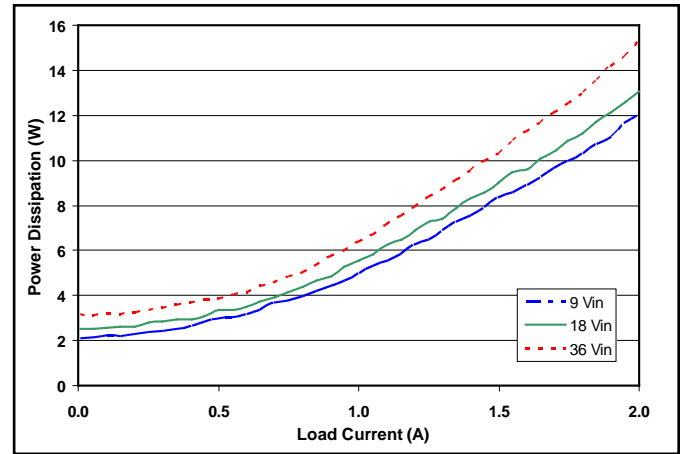


Figure 2: Power dissipation at nominal output voltage vs. load current for minimum, nominal, and maximum input voltage at 25°C.

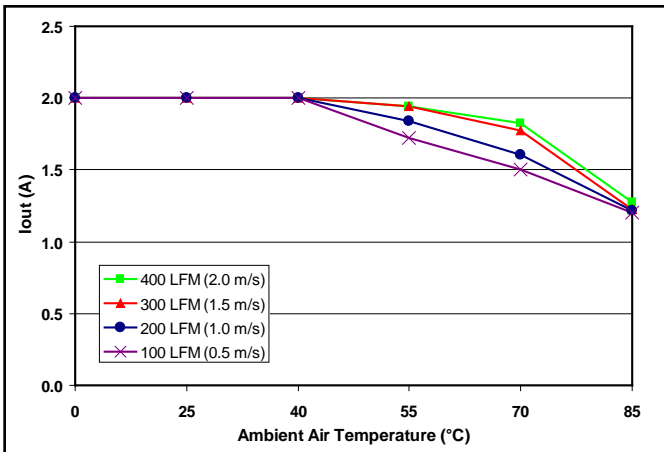


Figure 3: Encased converter (without heatsink) max. output power derating vs. ambient air temperature for airflow rates of 100 LFM through 400 LFM. Air flows across the converter from pin 3 to pin 1 (nominal input voltage).

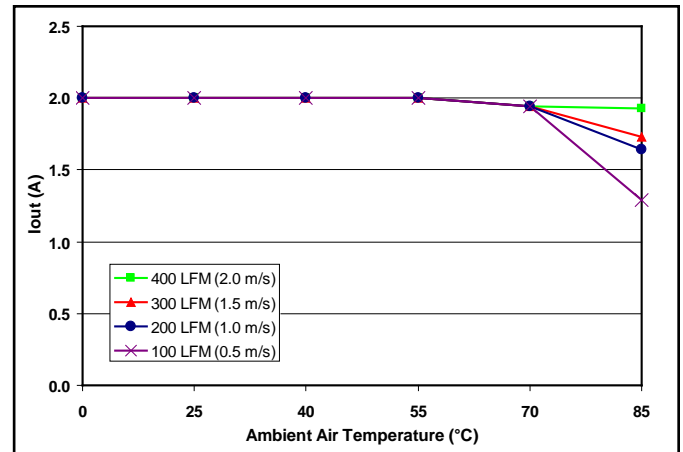


Figure 4: Encased converter (with 1/4" heatsink) max. output power derating vs. ambient air temperature for airflow rates of 100 LFM through 400 LFM. Air flows across the converter from pin 3 to pin 1 (nominal input voltage).

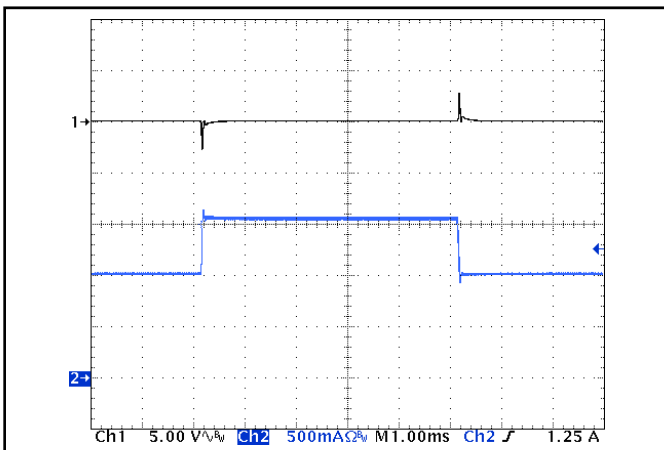


Figure 5: Output voltage response to step-change in load current (50%-75%-50% of I<sub>out</sub>(max); dI/dt = 0.02 A/μs). Load cap: 1 μF ceramic capacitor. Ch 1: V<sub>out</sub> (5 V/div), Ch 2: I<sub>out</sub> (1 A/div).

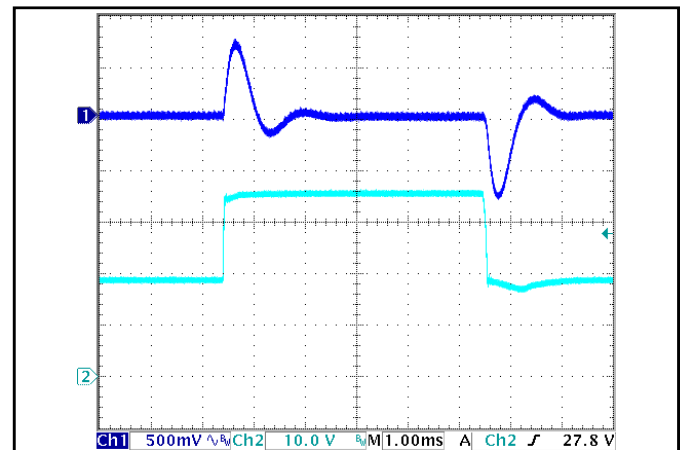


Figure 6: Output voltage response to step-change in input voltage (300 V/ms). Load cap: 100 μF, electrolytic output capacitance. Ch 1: V<sub>out</sub> (500 mV/div), Ch 2: V<sub>in</sub> (10 V/div).

## BASIC OPERATION AND FEATURES

This converter series uses a two-stage power conversion topology. The first stage is a buck-converter that keeps the output voltage constant over variations in line, load, and temperature. The second stage uses a transformer to provide the functions of input/output isolation and voltage step-up or step-down to achieve the output voltage required.

Both the first stage and the second stage switch at a fixed frequency for predictable EMI performance. Rectification of the transformer's output is accomplished with synchronous rectifiers. These devices, which are MOSFETs with a very low on-state resistance, dissipate far less energy than Schottky diodes. This is the primary reason that the converter has such high efficiency, even at very low output voltages and very high output currents.

These converters are offered totally encased to withstand harsh environments and thermally demanding applications. Dissipation throughout the converter is so low that it does not require a heatsink for operation in many applications; however, adding a heatsink provides improved thermal derating performance in extreme situations.

This series of converters uses the industry standard footprint and pin-out configuration.

## CONTROL FEATURES

**REMOTE ON/OFF (Pin 2):** The ON/OFF input, Pin 2, permits the user to control when the converter is on or off. This input is referenced to the return terminal of the input bus, Vin(-). The ON/OFF signal is active low (meaning that a low turns the converter on). Figure A details four possible circuits for driving the ON/OFF pin. Figure B is a detailed look of the internal ON/OFF circuitry.

**REMOTE SENSE(±) (Pins 7 and 5):** The SENSE(±) inputs correct for voltage drops along the conductors that connect the converter's output pins to the load.

Pin 7 should be connected to Vout(+) and Pin 5 should be connected to Vout(-) at the point on the board where regulation is desired. A remote connection at the load can adjust for a voltage drop only as large as that specified in this datasheet, that is

$$[V_{out(+)} - V_{out(-)}] - [V_{sense(+)} - V_{sense(-)}] \leq \text{Sense Range \%} \times V_{out}$$

Pins 7 and 5 must be connected for proper regulation of the output voltage. If these connections are not made, the converter will deliver an output voltage that is slightly higher than its specified value.

**Note:** the output over-voltage protection circuit senses the voltage across the output (pins 8 and 4) to determine when it should trigger, not the voltage across the converter's sense leads (pins 7 and 5). Therefore, the resistive drop on the board should be small enough so that output OVP does not trigger, even during load transients.

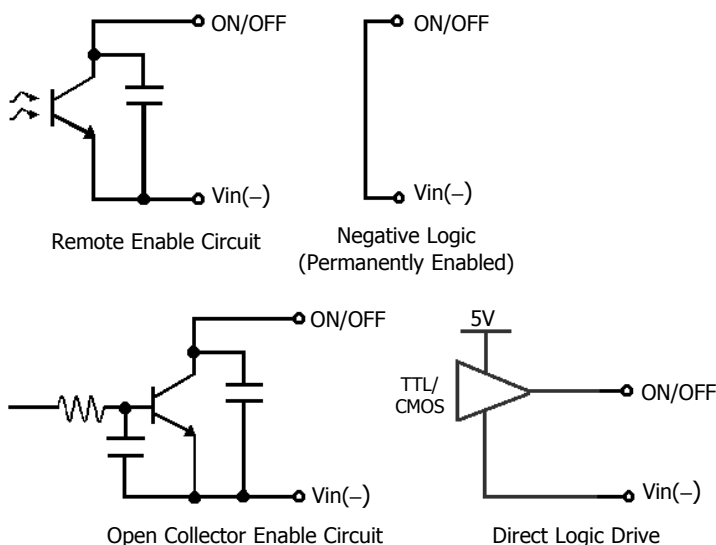


Figure A: Various circuits for driving the ON/OFF pin.

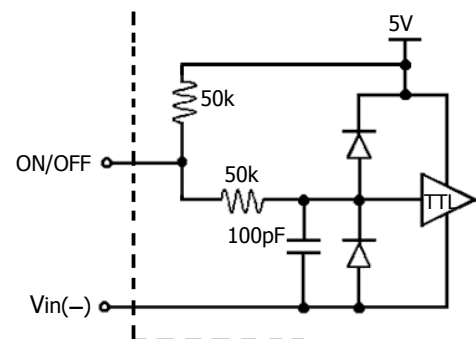


Figure B: Internal ON/OFF pin circuitry



**OUTPUT VOLTAGE TRIM (Pin 6):** The TRIM input permits the user to adjust the output voltage across the sense leads up or down according to the trim range specifications.

To decrease the output voltage, the user should connect a resistor between Pin 6 and Pin 5 (SENSE(-) input). For a desired decrease of the nominal output voltage, the value of the resistor should be

$$R_{\text{trim-down}} = \left( \frac{511}{\Delta\%} \right) - 10.22 \text{ (k}\Omega\text{)}$$

where

$$\Delta\% = \left| \frac{V_{\text{nominal}} - V_{\text{desired}}}{V_{\text{nominal}}} \right| \times 100\%$$

To increase the output voltage, the user should connect a resistor between Pin 6 and Pin 7 (SENSE(+) input). For a desired increase of the nominal output voltage, the value of the resistor should be

$$R_{\text{trim-up}} = \left( \frac{5.11V_{\text{OUT}} \times (100 + \Delta\%)}{1.225\Delta\%} - \frac{511}{\Delta\%} - 10.22 \right) \text{ (k}\Omega\text{)}$$

where  $V_{\text{out}}$  = Nominal Output Voltage

Graphs on Page 3 show the relationship between the trim resistor value and  $R_{\text{trim-up}}$  and  $R_{\text{trim-down}}$ , showing the total range the output voltage can be trimmed up or down.

**Note:** the TRIM feature does not affect the voltage at which the output over-voltage protection circuit is triggered. Trimming the output voltage too high may cause the over-voltage protection circuit to engage, particularly during transients.

It is not necessary for the user to add capacitance at the Trim pin. The node is internally bypassed to eliminate noise.

**Total DC Variation of  $V_{\text{OUT}}$ :** For the converter to meet its full specifications, the maximum variation of the dc value of  $V_{\text{OUT}}$ , due to both trimming and remote load voltage drops, should not be greater than that specified for the output voltage trim range.

## PROTECTION FEATURES

**Input Under-Voltage Lockout:** The converter is designed to turn off when the input voltage is too low, helping avoid an input system instability problem, described in more detail in the application note titled "0" on our website. The lockout circuitry is a comparator with dc hysteresis. When the input voltage is rising, it must exceed the typical Turn-On Voltage Threshold value (listed on the specifications page) before the converter will turn on. Once the converter is on, the input voltage must fall below the typical Turn-Off Voltage Threshold value before the converter will turn off.

**Output Current Limit:** The maximum current limit remains constant as the output voltage drops. However, once the impedance of the load across the output is small enough to make the output voltage drop below the specified Output DC Current-Limit Shutdown Voltage, the converter turns off.

The converter then enters a "hiccup mode" where it repeatedly turns on and off at a 5 Hz (nominal) frequency with a 5% duty cycle until the short circuit condition is removed. This prevents excessive heating of the converter or the load board.

**Output Over-Voltage Limit:** If the voltage across the output pins exceeds the Output Over-Voltage Protection threshold, the converter will immediately stop switching. This prevents damage to the load circuit due to 1) excessive series resistance in output current path from converter output pins to sense point, 2) a release of a short-circuit condition, or 3) a release of a current limit condition. Load capacitance determines exactly how high the output voltage will rise in response to these conditions. After 200 ms the converter will automatically restart.

**Over-Temperature Shutdown:** A temperature sensor on the converter senses the average temperature of the module. The thermal shutdown circuit is designed to turn the converter off when the temperature at the sensed location reaches the Over-Temperature Shutdown value. It will allow the converter to turn on again when the temperature of the sensed location falls by the amount of the Over-Temperature Shutdown Restart Hysteresis value.

## APPLICATION CONSIDERATIONS

**Input System Instability:** This condition can occur because any dc-dc converter appears incrementally as a negative resistance load. A detailed application note titled "Input System Instability" is available on the SynQor website which provides an understanding of why this instability arises, and shows the preferred solution for correcting it.

**Application Circuits:** Figure D provides a typical circuit diagram which details the input filtering and voltage trimming.

**Input Filtering and External Capacitance:** Figure E provides a diagram showing the internal input filter components. This filter dramatically reduces input terminal ripple current, which otherwise could exceed the rating of an external electrolytic input capacitor. The recommended external input capacitance is specified in the Input Characteristics section on the Electrical Characteristics page. More detailed information is available in the application note titled "EMI Characteristics" on the SynQor website.

**Startup Inhibit Period:** The Startup Inhibit Period ensures that the converter will remain off for approximately 200 ms when it is shut down for any reason. When an output short is present, this generates a 5 Hz "hiccup mode," which prevents the converter from overheating. In all, there are seven ways that the converter can be shut down, initiating a Startup Inhibit Period:

- Input Under-Voltage Lockout
- Output Over-Voltage Protection
- Over Temperature Shutdown
- Current Limit
- Short Circuit Protection
- Turned off by the ON/OFF input

Figure F shows three turn-on scenarios, where a Startup Inhibit Period is initiated at  $t_0$ ,  $t_1$ , and  $t_2$ :

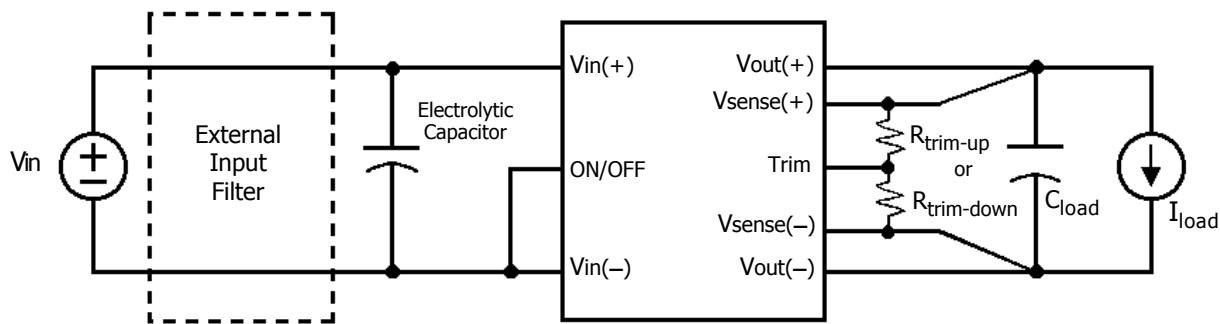


Figure D: Typical application circuit (negative logic unit, permanently enabled).

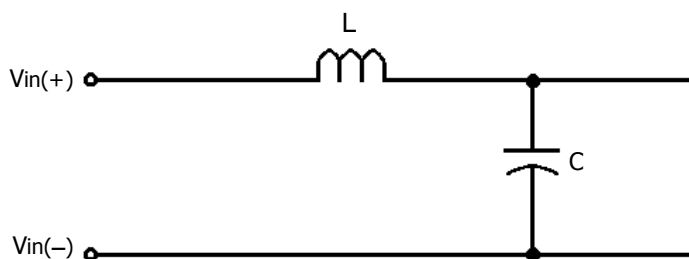


Figure E: Internal Input Filter Diagram (component values listed on the specifications page).

Before time  $t_0$ , when the input voltage is below the UVL threshold, the unit is disabled by the Input Under-Voltage Lockout feature. When the input voltage rises above the UVL threshold, the Input Under-Voltage Lockout is released, and a Startup Inhibit Period is initiated. At the end of this delay, the ON/OFF pin is evaluated, and since it is active, the unit turns on.

At time  $t_1$ , the unit is disabled by the ON/OFF pin, and it cannot be enabled again until the Startup Inhibit Period has elapsed.

When the ON/OFF pin goes high after  $t_2$ , the Startup Inhibit Period has elapsed, and the output turns on within the typical Turn-On Time.

**Thermal Considerations:** The maximum operating base-plate temperature,  $T_B$ , is 100 °C. As long as the user's thermal system keeps  $T_B \leq 100$  °C, the converter can deliver its full rated power.

A power derating curve can be calculated for any heatsink that is attached to the base-plate of the converter. It is only necessary to determine the thermal resistance,  $R_{THBA}$ , of the chosen heatsink between the base-plate and the ambient air for a given airflow rate. This information is usually available from the heatsink vendor. The following formula can be used to determine the

maximum power the converter can dissipate for a given thermal condition if its base-plate is to be no higher than 100 °C.

$$P_{diss}^{max} = \frac{100 \text{ }^\circ\text{C} - T_A}{R_{THBA}}$$

This value of power dissipation can then be used in conjunction with the data shown in Figure 2 to determine the maximum load current (and power) that the converter can deliver in the given thermal condition.

For convenience, Figures 3 and 4 provide Power derating curves for an encased converter without a heatsink and with a typical 1/4" high heatsink.

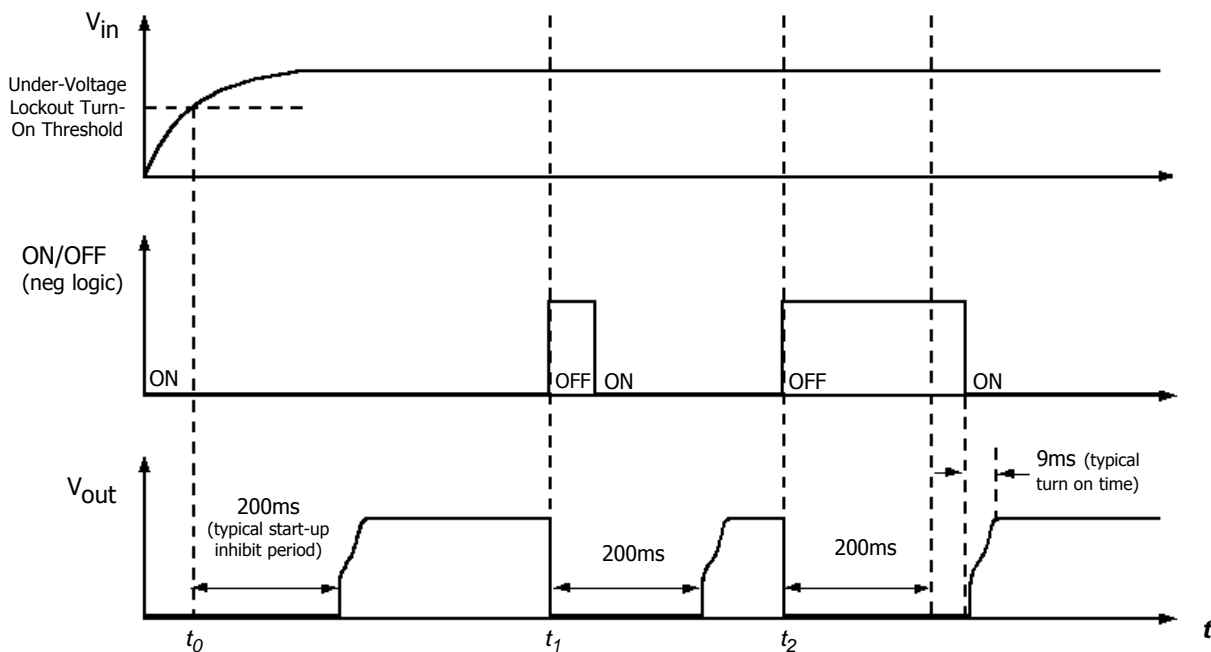
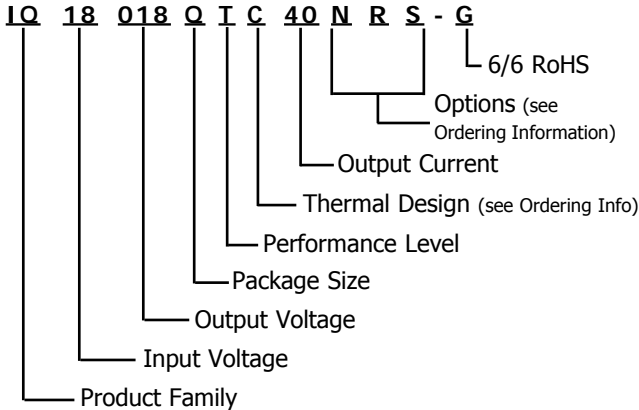


Figure F: Startup Inhibit Period (turn-on time not to scale)

### PART NUMBERING SYSTEM

The part numbering system for SynQor's InQor dc-dc converters follows the format shown in the example below.



The first 12 characters comprise the base part number and the last 3 characters indicate available options. The "-G" suffix indicates 6/6 RoHS compliance.

### Application Notes

A variety of application notes and technical white papers can be downloaded in pdf format from our website.

**RoHS Compliance:** The EU led RoHS (Restriction of Hazardous Substances) Directive bans the use of Lead, Cadmium, Hexavalent Chromium, Mercury, Polybrominated Biphenyls (PBB), and Polybrominated Diphenyl Ether (PBDE) in Electrical and Electronic Equipment. This SynQor product is 6/6 RoHS compliant. For more information please refer to SynQor's RoHS addendum available at our RoHS Compliance / Lead Free Initiative web page or e-mail us at rohs@synqor.com.

### Contact SynQor for further information:

**Phone:** 978-849-0600  
**Toll Free:** 888-567-9596  
**Fax:** 978-849-0602  
**E-mail:** power@synqor.com  
**Web:** www.synqor.com  
**Address:** 155 Swanson Road  
 Boxborough, MA 01719  
 USA

### ORDERING INFORMATION

The tables below show the valid model numbers and ordering options for converters in this product family. When ordering SynQor converters, please ensure that you use the complete 15 character part number consisting of the 12 character base part number and the additional 3 characters for options. A "-G" suffix indicates the product is 6/6 RoHS compliant.

Model Number	Continuous Input Voltage	Transient Input Voltage	Output Voltage	Maximum Output Current
IQ18018QTC40xyz	9 - 36 V	40 V - 100 ms	1.8 V	40 A
IQ18033QTC30xyz	9 - 36 V	40 V - 100 ms	3.3 V	30 A
IQ18050QTC20xyz	9 - 36 V	40 V - 100 ms	5 V	20 A
IQ18070QTC14xyz	9 - 36 V	40 V - 100 ms	7 V	14 A
IQ18120QTC08xyz	9 - 36 V	40 V - 100 ms	12 V	8 A
IQ18150QTC07xyz	9 - 36 V	40 V - 100 ms	15 V	7 A
IQ18240QTC04xyz	9 - 36 V	40 V - 100 ms	24 V	4 A
IQ18300QTC03xyz	9 - 36 V	40 V - 100 ms	30 V	3 A
IQ18480QTC02xyz	9 - 36 V	40 V - 100 ms	48 V	2 A

The following options must be included in place of the x y z spaces in the model numbers listed above.

Options Description: x y z		
Enable Logic	Pin Length	Feature Set
N - Negative	R - 0.180"	S - Standard

Not all combinations make valid part numbers, please contact SynQor for availability.

### PATENTS

SynQor holds the following patents, one or more of which might apply to this product:

5,999,417	6,222,742	6,545,890	6,577,109
6,594,159	6,731,520	6,894,468	6,896,526
6,927,987	7,050,309	7,072,190	7,085,146
7,119,524	7,269,034	7,272,021	7,272,023
7,558,083	7,564,702		

### Warranty

SynQor offers a three (3) year limited warranty. Complete warranty information is listed on our website or is available upon request from SynQor.

Information furnished by SynQor is believed to be accurate and reliable. However, no responsibility is assumed by SynQor for its use, nor for any infringements of patents or other rights of third parties which may result from its use. No license is granted by implication or otherwise under any patent or patent rights of SynQor.