



Expertise Applied | Answers Delivered



PRODUCT  
CATALOG  
& DESIGN  
GUIDE



# VARISTOR

**Circuit Protection Products**

# Littelfuse Circuit Protection Solutions Port

Consumer Electronics | Telecom | White Goods | Medical Equipment | TVSS and Power

## DESIGN SUPPORT

**Live Application Design and Technical Support**—Tap into our expertise. Littelfuse engineers are available around the world to help you address design challenges and develop unique, customized solutions for your products.

**Product Sampling Programs**—Most of our products are available as samples for testing and verification within your circuit design. Visit [Littelfuse.com](http://Littelfuse.com) or contact a Littelfuse product representative for additional information.

**Product Evaluation Labs and Services**—Littelfuse global labs are the hub of our new product development initiatives, and also provide design and compliance support testing as an added-value to our customers.



## OVERVOLTAGE SUPPRESSION TECHNOLOGIES (1-6)

**1. TVS Diodes** — Suppress overvoltage transients such as Electrical Fast Transients (EFT), inductive load switching and lightning in a wide variety of applications in the computer, industrial, telecom and automotive markets.

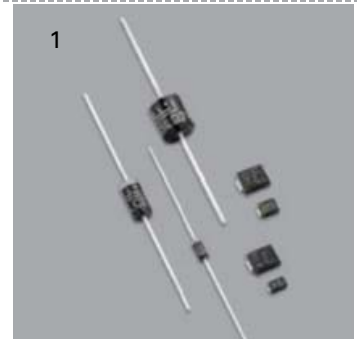
**2. Varistors** — Multiple forms, from Metal Oxide Varistors (MOVs) that suppress transient voltages to Multi-Layer Varistors (MLVs) designed for applications requiring protection from various transients in computers and handheld devices as well as industrial and automotive applications.

**3. SIDACTor® Devices** — Complete line of protection thyristor products specifically designed to suppress overvoltage transients in a broad range of telecom and datacom applications.

**4. Gas Plasma Arrestors (GDTs)** — Available in small footprint leaded and surface mount configurations, Littelfuse GDTs respond fast to transient overvoltage events, reducing the risk of equipment damage.

**5. SPA™ Silicon Protection Arrays** — Designed specifically to protect analog and digital signal lines from electrostatic discharge (ESD) and other overvoltage transients.

**6. PulseGuard® ESD Suppressors** — Available in various surface mount form factors to protect high-speed digital lines without causing signal distortion.



Visit

# tection folio

Supplies | Lighting | General Electronics

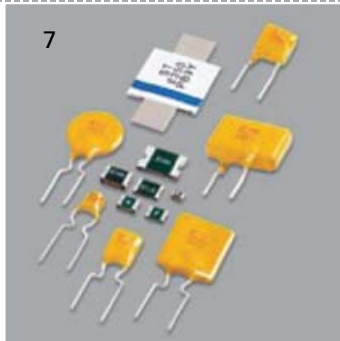
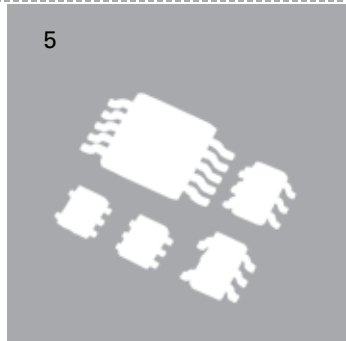
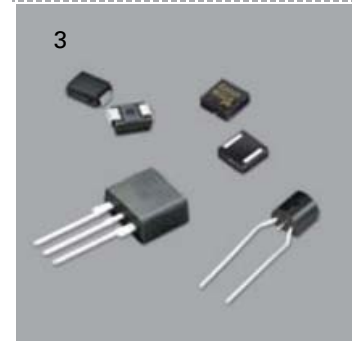
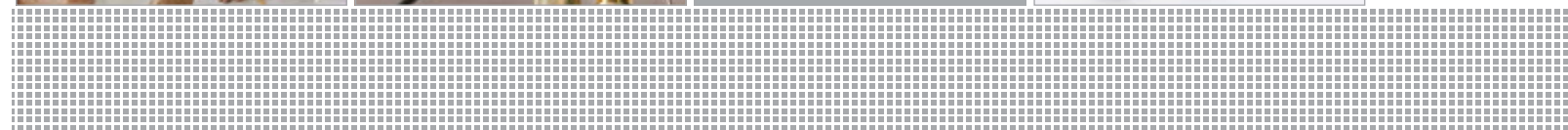
## SWITCHING TECHNOLOGIES

### Switching Thyristors—

Solid-state switches used to control the flow of electrical current in applications, capable of withstanding rated blocking/off-state voltage until triggered to on-state.

## ACCESSORIES

In addition to our broad portfolio of circuit protection technologies, we offer an array of **fuse holders** including circuit board, panel or in-line wire mounted devices to support a wide range of application requirements.

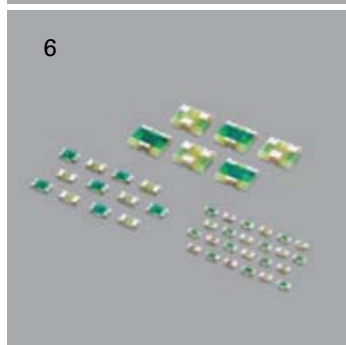
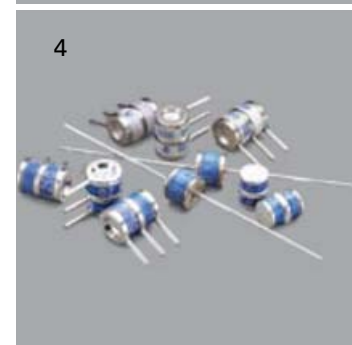


## OVERCURRENT PROTECTION TECHNOLOGIES (7-8)

### 7. Positive Temperature Coefficient Devices (PTCs)—

Provide resettable overcurrent protection for a wide range of applications.

**8. Fuses** — Full range including surface mount, axial, glass or ceramic, thin-film or Nano<sup>2</sup><sup>®</sup> style, fast-acting or SloBlo<sup>®</sup>, MINI<sup>®</sup> and ATO<sup>®</sup> fuses.



[www.littelfuse.com](http://www.littelfuse.com) for more information.



## Overvoltage Protection with Littelfuse Varistors

Littelfuse offers Varistor protective devices with peak current ratings from 20A-70,000A, peak energy ratings from 0.01J-10,000J, and mounting options to serve a wide range of applications.

The Littelfuse MLV (Multilayer Varistor) family consists of compact surface mount devices with enhanced performance and filtering characteristics for circuit board-level applications. They protect against electrostatic discharge, EFT and surge, offer low capacitance for high data rates and high capacitance for EMI filtering, and are widely used in computers, handheld devices, and automotive electronics.





































The Littelfuse MOV (Metal Oxide Varistor) family suppresses higher energy voltage transients such as that generated by electrical load switching and lightning. Offered in mounting options including bare disk, terminal connection and radial and axial leaded packages, they are often used in power supply, appliance and industrial applications.

### Features

- Many form factor and protection ranges available
- High surge capability – up to 70,000A
- Rugged cost effective protection
- Thermal protection options available
- RoHS compliant



## TABLE OF CONTENTS

Varistor Products Overview			Overview
	Product Selection Worksheet and Guide	4-5	
	Varistor Application Guide	6	
	Introduction to Overvoltage Suppression	7-9	
	Introduction to Varistor Technology	10-17	
	How to Connect a Littelfuse Varistor	18-19	
	Varistor Terms and Definitions	20-21	
	Agency Standards	22-23	
Surface Mount Varistors (MOVs and MLVs)			Surface Mount Items
	MHS Series Multilayer High-Speed Surface Mount ESD Voltage Suppressor	25	
	MLE Series Multilayer Surface Mount ESD Suppressor/Filter	31	
	ML Series Multilayer Surface Mount Transient Voltage Surge Suppressor	37	
	MLN SurgeArray™ Four Line Multilayer Transient Voltage Suppressor	45	
	AUML Series Multilayer Surface Mount Automotive Transient Surge Suppressor	51	
	CH Series Monolithic Chip Transient Voltage Suppressor	59	
 	<b>NEW!</b> SM7 Series Surface Mount Varistor for Line Voltage Operation (see also LA and ZA series)	65	
Radial Lead Varistors (Radial MOVs)			Standard Radial Items
 	TMOV® and iTMOV® Radial Lead Thermally Protected Metal Oxide Varistors	69	
 	TMOV25S® Thermally Protected Metal Oxide Varistor	79	
 	UltraMOV™ Radial Lead Metal Oxide Varistors	87	
 	UltraMOV™ 25S Series High Surge Current Radial Lead Metal Oxide Varistors	99	
 	C-III Series High Energy Radial Lead Varistors	105	
 	LA Series Radial Lead Metal Oxide Varistors for Line Voltage Operation	115	
 	ZA Series Radial Lead Metal Oxide Varistors for Low to Medium Voltage Operation	129	
Industrial High Energy Varistors (High Energy MOVs)			Hi Energy Items
 	BA/BB Series Industrial High Energy Metal Oxide Varistors	143	
 	DA/DB Series Industrial High Energy Metal Oxide Varistors	149	
 	HA Series Industrial High Energy Metal Oxide Varistors	153	
 	TMOV34S® High Energy, Thermally Protected Metal Oxide Varistors	159	
 	HB34, HF34 and HG34 Series Industrial High Energy Metal Oxide Varistors	167	
 	DHB34 Series Industrial High Energy Metal Oxide Varistors	175	
 	CA Series Industrial High Energy Metal Oxide Disc Varistors	181	
Other Application Specific Varistors			Specialty Items
	MA Series Axial Lead Metal-Oxide Varistors	187	
	RA Series Low Profile Lead	193	
	High Reliability Series	201	



## Introduction

To assure reliable operation, transient voltage suppression should be considered at early stages of the design process. This can be a complex task as electronic components are increasingly sensitive to stray electrical transients. The designer must define the types of transient threats and determine what applications are needed while meeting the product agency norms and standards.

Varistors are increasingly used as the front-line solution for transient surge protection. Littelfuse provides expertise to the designer and offers the broadest range of circuit protection technologies to choose from.

Littelfuse varistors are available in a variety of forms to serve a wide range of applications. Options include ultra small surface mount multi-layer suppressor (MLV) devices for small electronics applications, and traditional mid-range metal-oxide (MOV) radial and axial leaded devices for protection of small machinery, power sources and components. Littelfuse also offers larger terminal mount MOVs for industrial applications.

A more recent innovation to the the Littelfuse product line, MLVs address a specific part of the transient voltage spectrum – the circuit board level environment


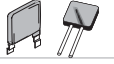
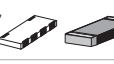
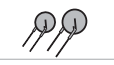
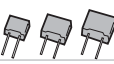
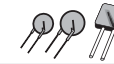
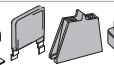


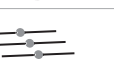

where, although lower in energy, transients from ESD, inductive load switching, and even lightning surge remnants would otherwise reach sensitive integrated circuits. Each of these events can relate to a product's ElectroMagnetic Compatibility (EMC), or its immunity to transients that could cause damage or malfunction.

Littelfuse offers five distinct versions of MLVs including the MHS Series ESD Suppressor for high data rates, the ML Series which supports the broadest application range, the MLE Series intended for ESD while providing filter functions, the MLN Series Quad Array in a 1206 & 0805 chip and the AUML Series characterized for the specific transients found in automotive electronic systems.

This catalog and design guide includes selection tables, technology tutorials, and detailed product technical information, to aid you in choosing the correct Littelfuse Varistor to serve your application.

Please visit [www.littelfuse.com](http://www.littelfuse.com) regularly to find the most current Littelfuse varistor product information.

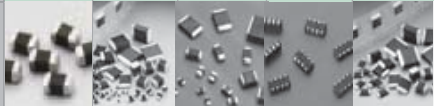
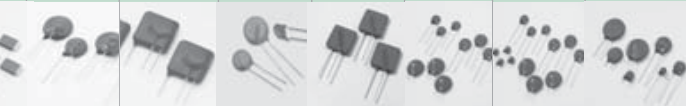
Additional design support information can be found at <http://www.littelfuse.com/design-support.html>

Peak Current (A)	Energy (J)	Maximum Steady-State Applied Voltage											Disc Sizes / Packages		
		Volts AC RMS			115	150	264	320				1,000		2,800	6,000
		4	10	25	130	250	275	460	660	750	1,200	3,500		7,000	
		Volts DC			200	365									
		3.5	14	35	175	330	369	615	850	970	1,200	3,500	7,000		
6,500–10,000	50–273					TMOV® and iTMOV®								14, 20 (mm) 	
20,000–40,000	170–1050					Industrial TMOV25S® and TMOV34S®								25, 34 (mm) 	
30–1,000	0.1–25					MLVs and CH Series								0402, 0603, 1206, 1210, 1812, 2220, 5x8 mm 	
50–6,500	0.1–52					ZA Series								5, 7, 10, 14, 20 (mm) 	
100–6,500	0.4–160					RA Series								5x8, 10x16, 14x22 (mm) 	
1,200–22,000	11–890					C-III, LA, UltraMOV™ Series								7, 10, 14, 20, 25 (mm) 	
25,000–40,000	160–1,050					HA, HB, HC, HF, HG, DA/DB, DHB Series								32, 34, 40 (mm) 	
50,000–70,000	450–10,000					BA/BB Series								60 mm 	
50,000–70,000	880–10,000					CA Series								60 (mm) 	
40–100	0.06–1.7					MA Series								3 (mm) 	
100–6500	0.4–190					Hi-Reliability Series								ZA series, DA/DB Series 	







## Product Selection Guide

Type	Surface Mount MLVs						Radial Leaded MOVs						
Series	MHS	MLE	ML	MLN	AUML	CH	TMOV® and iTMOV®	iTMOV®25S	UltraMOV™	UltraMOV™ 25S	C-III	LA	ZA
Image													
PAGE NUMBER	<b>25</b>	<b>31</b>	<b>37</b>	<b>45</b>	<b>51</b>	<b>59</b>	<b>69</b>	<b>79</b>	<b>87</b>	<b>99</b>	<b>105</b>	<b>115</b>	<b>129</b>
Technology Type	Ceramic					Multilayer Zinc Oxide	Zinc Oxide	Zinc Oxide					
Operating AC Voltage Range	9 - 42	18	2.7 - 107	18	—	14-275	115-750	115-750	130-625	115-750	130-660	130-1000	4-460
Operating DC Voltage Range	30 - 135	18	5.5 - 120	5.5 - 18	18	18-369	—	—	170-825	150-970	—	175-1200	5.5-615
Peak Current Range (A)**	300	22 - 28	4 - 500	30	20	250-500	6000-10000	20000	1750-10000	22000	3500-9000	1200-6500	50-6500
Peak Energy Range (J)			0.02 - 2.5	0.05 - 0.10	—	1-23	35-480	170 - 670	12.5-720	230-890	40-530	11-360	0.1-52
Temperature Range (Deg.°C)	-55 to +125°C						-55 to +85°C						
Lines Protected	1		4		1		1						
Mount/Form Factor	Surface Mount						Radial Leaded						
Disc Size (MOV)	(Not Applicable)						14, 20 mm round	25 mm square	7, 10, 14, 20 mm round	25 mm square	10, 14, 20 mm round	7, 10, 14, 20 mm round	5, 7, 10, 14, 20 mm round
Agency Approvals	—	—	—	—	—	UL	UL, CSA, VDE, CECC	UL Pending	UL, CSA, VDE, CECC	UL, CSA, VDE, CECC	UL, CSA, VDE	UL, CSA, VDE, CECC	UL, VDE
RoHS Compliant	Refer to Datasheets												
Lead-free	Refer to Datasheets												

\* Not an applicable parameter for this technology  
 \*\* Not an applicable parameter for Crowbar devices

Type	Industrial High Energy MOVs							Special MOVs			
Series	BA/BB	DA/DB	HA	TMOV34S®	HB34, HG34 HF34	DHB34	CA	MA	RA	High Reliability	
Image											
PAGE NUMBER	<b>143</b>	<b>149</b>	<b>153</b>	<b>159</b>	<b>167</b>	<b>175</b>	<b>181</b>	<b>187</b>	<b>193</b>	<b>201</b>	
Technology Type	Zinc Oxide										
Operating AC Voltage Range	130-2800	130-750	130-750	115-750	130-750	250-2800	250-2800	9-264	4-275	130-510	
Operating DC Voltage Range	175-3500	175-970	175-970	—	175-970	330-3,500	330-3,500	13-365	5.5-369	4-675	
Peak Current Range (A)**	50000 70000	40000	25000 40000	40000	40000	20000 70000	20000 70000	40-100	100-6500	100-6500	
Peak Energy Range (J)	450-10000	270-1050	200-1050	235-1050	270-1050	330-10000	330-10000	0.06-1.7	0.4-160	0.4-190	
Temperature Range (Deg.°C)	-55 to +85°C										
Lines Protected	1										
Mount/Form Factor	Screw / Clip Terminals		Industrial Packaged Radial Leads				Bare Disc	Axial Leaded	Inline Radial Leads	(Varies)	
Disc Size (MOV)	60 mm round	40 mm round	32, 40 mm round	34 mm square			60 mm round	Not Applicable		(Varies)	
Agency Approvals	UL	UL	UL & CSA	UL	UL & CSA	—	—	—	UL, CSA	MIL, QPL, CECC, CSA	
RoHS Compliant	No	No	No	Yes	No	Yes	Yes	Yes	Yes	No	
Lead-free	No	No	No	Yes	No	No	No	Yes	Yes	No	

## Varistor Application Guides

MARKET SEGMENT	TYPICAL APPLICATIONS AND CIRCUIT EXAMPLES		DEVICE FAMILY OR SERIES	TECHNOLOGY	SURFACE MOUNT PRODUCTS
<b>Low Voltage, Board Level Products</b>	<ul style="list-style-type: none"> <li>Hand-Held/Portable Devices</li> <li>EDP</li> <li>Computer</li> <li>I/O Port and Interfaces</li> </ul>	<ul style="list-style-type: none"> <li>Controllers</li> <li>Instrumentation</li> <li>Remote Sensors</li> <li>Medical Electronics, Etc.</li> </ul>	CH	MOV	√
			MA, ZA, RA	MOV	
			ML, MLE, MLN, MHS	MLV	√
<b>AC Line, TVSS Products</b>	<ul style="list-style-type: none"> <li>UPS</li> <li>AC Panels</li> <li>AC Power Taps</li> <li>TVSS Devices</li> <li>AC Appliance/Controls</li> </ul>	<ul style="list-style-type: none"> <li>Power Meters</li> <li>Power Supplies</li> <li>Circuit Breakers</li> <li>Consumer Electronics</li> </ul>	TMOV®, UltraMOV™, C-111, LA, HA, HB, HG, HF, DHB, TMOV34S®, RA	MOV	
			CH	MOV	√
<b>Automotive Electronics</b>	<ul style="list-style-type: none"> <li>ABS</li> <li>EEC</li> <li>Instrument Center</li> <li>Air Bag</li> <li>Window Control/ Wiper Modules</li> </ul>	<ul style="list-style-type: none"> <li>Body Controllers</li> <li>Multiplex Bus</li> <li>EFI</li> </ul>	CH	MOV	√
			ZA	MOV	
			AUML, ML, MLE, MLN, MHS	MLV	√
<b>Telecommunications Products</b>	<ul style="list-style-type: none"> <li>Cellular/Cordless Phone</li> <li>Modems</li> <li>Secondary Phone Line Protectors</li> <li>Data Line Connectors</li> </ul>	<ul style="list-style-type: none"> <li>Repeaters</li> <li>Line Cards</li> <li>COE</li> <li>T1/E1/ISDN</li> </ul>	CH	MOV	√
			ZA	MOV	
			ML, MLE, MLN, MHS	MLV	√
<b>Industrial High Energy AC Products</b>	<ul style="list-style-type: none"> <li>High Current Relays</li> <li>Solenoids</li> <li>Motor Drives</li> <li>AC Distribution Panels</li> </ul>	<ul style="list-style-type: none"> <li>Robotics</li> <li>Large Motors/Pumps/Compressors</li> </ul>	DA/DB, BA/BB, CA, HA, HB, HC, HG, HF, DHB, TMOV34S®	MOV	

Available in both surface-mount and through-hole packages.

## Introduction to Overvoltage Suppression

### Transient Threats – What Are Transients?

Voltage transients are defined as short duration surges of electrical energy and are the result of the sudden release of energy that was previously stored, or induced by other means, such as heavy inductive loads or lightning strikes. In electrical or electronic circuits, this energy can be released in a predictable manner via controlled switching actions, or randomly induced into a circuit from external sources.

Repeatable transients are frequently caused by the operation of motors, generators, or the switching of reactive circuit components. Random transients, on the other hand, are often caused by Lightning (Figure 1) and Electrostatic Discharge (ESD) (Figure 2). Lightning and ESD generally occur unpredictably, and may require elaborate monitoring to be accurately measured, especially if induced at the circuit board level. Numerous electronics standards groups have analyzed transient voltage occurrences using accepted monitoring or testing methods. The key characteristics of several transients are shown below in Table 1.

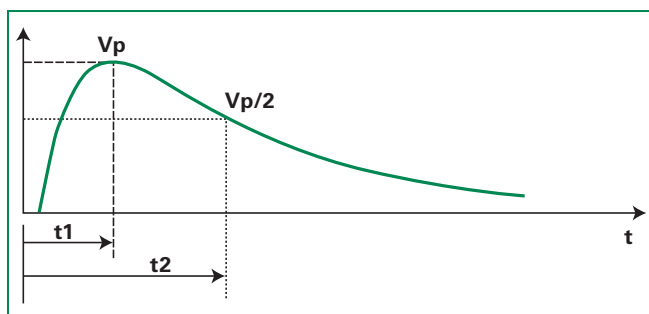


Figure 1. Lightning Transient Waveform

	VOLTAGE	CURRENT	RISE-TIME	DURATION
Lighting	25kV	20kA	10 $\mu$ s	1ms
Switching	600V	500A	50 $\mu$ s	500ms
EMP	1kV	10A	20ns	1ms
ESD	15kV	30A	<1ns	100ns

Table 1. Examples of transient sources and magnitude

### Characteristics of Transient Voltage Spikes

Transient voltage spikes generally exhibit a "double exponential" wave form, shown in Figure 1 for lightning and figure 2 for ESD. The exponential rise time of lightning is in the range 1.2 $\mu$ s to 10 $\mu$ s (essentially 10% to 90%) and the duration is in the range of 50 $\mu$ s to 1000 $\mu$ s (50% of peak values). ESD on the other hand, is a much shorter duration event. The rise time has been characterized at less than 1 ns. The overall duration is approximately 100ns.

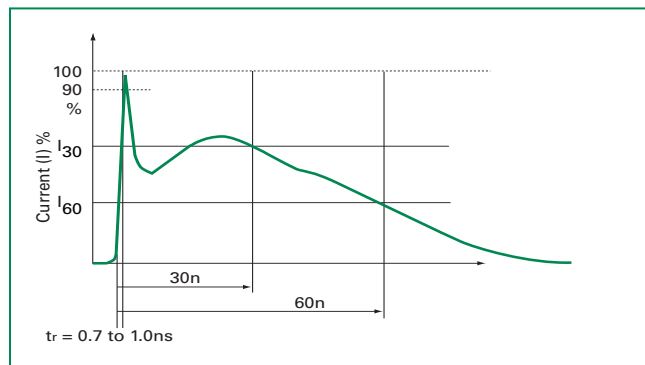


Figure 2. ESD Test Waveform

### Why are Transients of Increasing Concern?

Component miniaturization has resulted in increased sensitivity to electrical stresses. Microprocessors for example, have structures and conductive paths which are unable to handle high currents from ESD transients. Such components operate at very low voltages, so voltage disturbances must be controlled to prevent device interruption and latent or catastrophic failures. Sensitive devices such as microprocessors are being adopted at an exponential rate. Microprocessors are beginning to perform transparent operations never before imagined. Everything from home appliances, such as dishwashers, to industrial controls and even toys, have increased the use of microprocessors to improve functionality and efficiency.

Vehicles now employ many electronics systems to control the engine, climate, braking and, in some cases, steering systems. Some of the innovations are designed to improve efficiency, but many are safety related, such as ABS and traction control systems. Many of the features in appliances and automobiles use modules which present transient threats (such as electric motors). Not only is the general environment hostile, but the equipment or appliance can also be sources of threats. For this reason, careful circuit design and the correct use of overvoltage protection technology will greatly improve the reliability and safety of the end application. Table 2 shows the vulnerability of various component technologies.

Device Type	Vulnerability (volts)
VMOS	30-1800
MOSFET	100-200
GaAsFET	100-300
EPROM	100
JFET	140-7000
CMOS	250-3000
Schottky Diodes	300-2500
Bipolar Transistors	380-7000
SCR	680-1000

Table 2: Range of device vulnerability.

## Transient Voltage Scenarios

### ESD (Electrostatic Discharge)

Electrostatic discharge is characterized by very fast rise times and very high peak voltages and currents. This energy is the result of an imbalance of positive and negative charges between objects.

Below are some examples of the voltages which can be generated, depending on the relative humidity (RH):

- **Walking across a carpet:**  
35kV @ RH = 20%; 1.5kV @ RH = 65%
- **Walking across a vinyl floor:**  
12kV @ RH = 20%; 250V @ RH = 65%
- **Worker at a bench:**  
6kV @ RH = 20%; 100V @ RH = 65%
- **Vinyl envelopes:**  
7kV @ RH = 20%; 600V @ RH = 65%
- **Poly bag picked up from desk:**  
20kV @ RH = 20%; 1.2kV @ RH = 65%

Referring to Table 2 on the previous page, it can be seen that ESD that is generated by everyday activities can far surpass the vulnerability threshold of standard semiconductor technologies. Figure 2 shows the ESD waveform as defined in the IEC 61000-4-2 test specification.

### Inductive Load Switching

The switching of inductive loads generates high energy transients which increase in magnitude with increasingly heavy loads. When the inductive load is switched off, the collapsing magnetic field is converted into electrical energy which takes the form of a double exponential transient. Depending on the source, these transients can be as large as hundreds of volts and hundreds of Amps, with duration times of 400ms.

Typical sources of inductive transients are:

- **Generator**
- **Motor**
- **Relay**
- **Transformer**

These examples are extremely common in electrical and electronic systems. Because the sizes of the loads vary according to the application, the wave shape, duration, peak current and peak voltage are all variables which exist in real world transients. Once these variables can be approximated, a suitable suppressor technology can be selected.

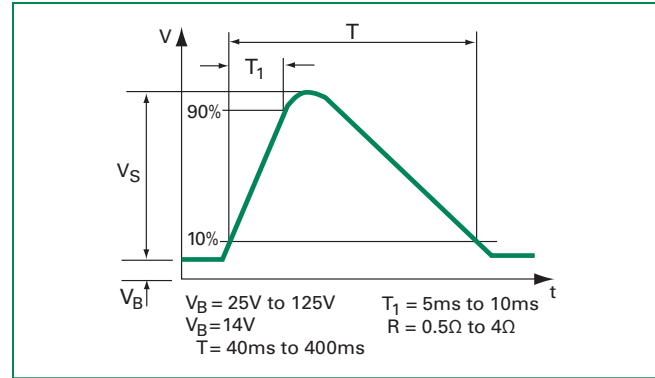


Figure 3. Automotive Load Dump

Figure 3, shows a transient which is the result of stored energy within the alternator of an automobile charging system. A similar transient can also be caused by other DC motors in a vehicle. For example, DC motors power amenities such as power locks, seats and windows. These various applications of a DC motor can produce transients that are just as harmful to the sensitive electronic components as transients created in the external environment.

### Lightning Induced Transients

Even though a direct strike is clearly destructive, transients induced by lightning are not the result of a direct strike. When a lightning strike occurs, the event creates a magnetic field which can induce transients of large magnitude in nearby electrical cables.

Figure 4, shows how a cloud-to-cloud strike will effect not only over RHead cables, but also buried cables. Even a strike 1 mile distant (1.6km) can generate 70V in electrical cables.

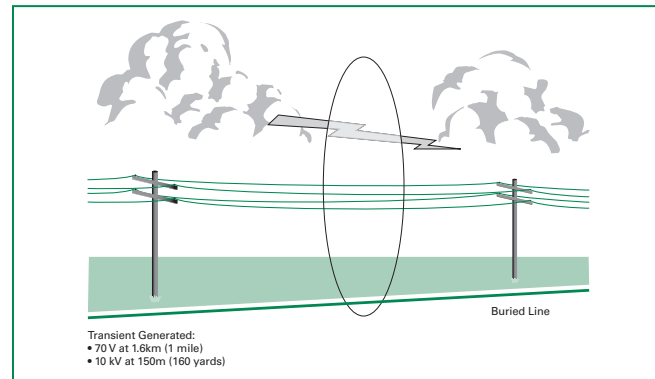


Figure 4. Cloud-to-Cloud Lightning Strike

Figure 5, on the following page, shows the effect of a cloud-to-ground strike: the transient-generating effect is far greater.

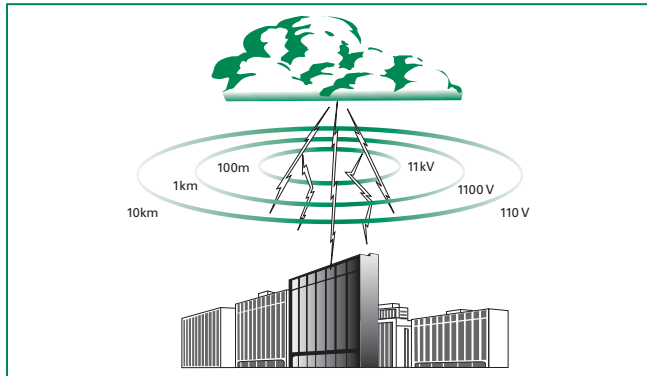


Figure 5. Cloud-to-Ground Lightning Strike

Figure 6, shows a typical current waveform for induced lightning disturbances.

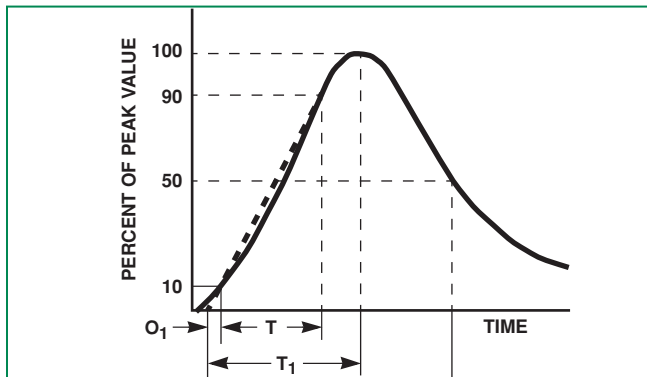


Figure 6. Peak Pulse Current Test Waveform

**Technological Solutions for Transient Threats**

Because of the various types of transients and applications, it is important to correctly match the suppression solution to the different applications. Littelfuse offers the broadest range of circuit protection technologies to ensure that you get the proper solution for your application. Please consult our online library of Application Notes and Design Notes for further information on common design issues encountered at <http://www.littelfuse.com>.

**Metal Oxide Varistors and Multi-Layered Varistors**

Varistors are voltage dependent, nonlinear devices which have electrical characteristics similar to back-to-back Zener diodes. They are composed primarily of  $Z_{N}O$  with small additions of other metal oxides such as Bismuth, Cobalt, Magnese and others. The Metal Oxide Varistor or "MOV" is sintered during the manufacturing operation into a ceramic semiconductor and results in a crystalline microstructure that allows MOVs to dissipate very high levels of transient energy across the entire bulk of the device. Therefore, MOVs are typically used for the suppression of lightning and other high energy transients found in industrial or AC line applications. Additionally, MOVs are used in DC circuits such as low voltage power supplies and automobile applications. Their manufacturing process permits many different form factors with the radial leaded disc being the most common.

Multilayer Varistors or MLVs are constructed of  $Z_{N}O$  material similar to standard MOVs, however, they are fabricated with interweaved layers of metal electrodes and supplied in leadless ceramic packages. As with standard MOVs, Multilayers transition from a high impedance to a conduction state when subjected to voltages that exceed their nominal voltage rating. MLVs are constructed in various chip form sizes and are capable of significant surge energy for their physical size. Thus, data line and power supply suppression are achieved with one technology.

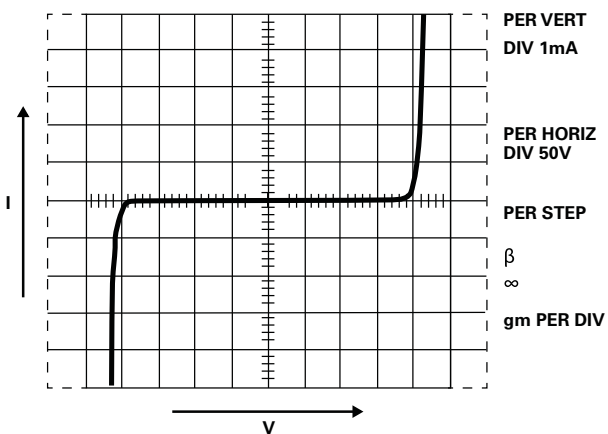
*The following parameters apply to Varistors and/or Multilayer Varistors and should be understood by the circuit designer to properly select a device for a given application.*

The three Littelfuse technologies described offer a comprehensive choice for the designer. Reviewing the attributes of each can result in a suitable ESD suppression solution for most applications. See the individual data sheets for specific electrical and mechanical information.



## Introduction to Varistor Technology

The varistor body structure consists of a matrix of conductive  $ZnO$  grains separated by grain boundaries providing P-N junction semiconductor characteristics. These boundaries are responsible for blocking conduction at low voltages and are the source of the nonlinear electrical conduction at higher voltages.



**FIGURE 1. TYPICAL VARISTOR V-I CHARACTERISTIC**

The symmetrical, sharp breakdown characteristics shown in Figure 1, enable the varistor to provide excellent transient suppression performance. When exposed to high voltage transients the varistor impedance changes many orders of magnitude from a near open circuit to a highly conductive level, thus clamping the transient voltage to a safe level. The potentially destructive energy of the incoming transient pulse is absorbed by the varistor, thereby protecting vulnerable circuit components.

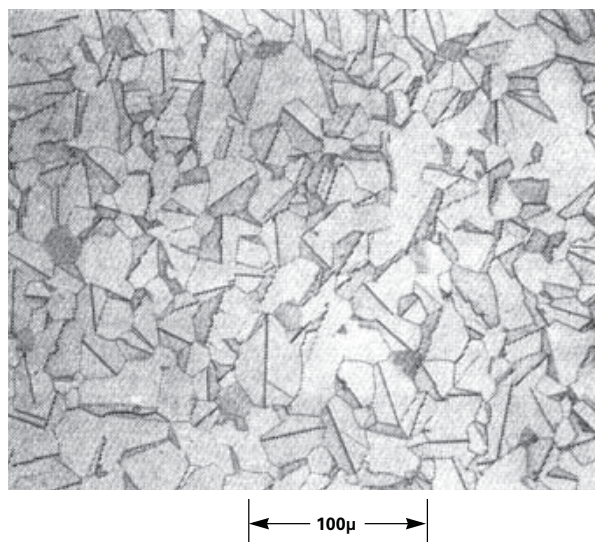
Since electrical conduction occurs, in effect, between  $ZnO$  grains distributed throughout the bulk of the device, the Littelfuse Varistor is inherently more rugged than its single P-N junction counterparts, such as Zener diodes. In the varistor, energy is absorbed uniformly throughout the body of the device with the resultant heating spread evenly through its volume. Electrical properties are controlled mainly by the physical dimensions of the varistor body which is sintered in various form factors such as discs, chips and tubes. The energy rating is determined by volume, voltage rating by thickness or current flow path length, and current capability by area measured normal to the direction of current flow.

### Physical Properties

MOVs are designed to protect sensitive circuits against external transients (lightning) and internal transients (inductive load switching, relay switching and capacitor discharges). And other high level transients found in industrial, AC line application or lower level transients found in automotive DC line applications with peak current rating ranging from 20A to 500A and peak energy rating from 0.05J – 2.5J.

An attractive property of the MOV is that the electrical characteristics are related to the bulk of the device. Each  $ZnO$  grain of the ceramic acts as if it has a semiconductor junction at the grain boundary. A cross-section of the material is shown in Figure 2, which illustrates the ceramic microstructure. Varistors are fabricated by forming and sintering Zinc Oxide-based powders into ceramic parts. These parts are then electroded with either thick film Silver or arc/flame sprayed metal.

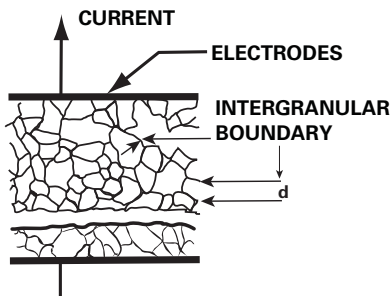
The  $ZnO$  grain boundaries can be clearly observed. Since the nonlinear electrical behavior occurs at the boundary of each semiconducting  $ZnO$  grain, the varistor can be considered a "multi-junction" device composed of many series and parallel connections of grain boundaries. Device behavior may be analyzed with respect to the details of the ceramic microstructure. Mean grain size and grain size distribution play a major role in electrical behavior.



**FIGURE 2. OPTICAL PHOTOMICROGRAPH OF A POLISHED AND ETCHED SECTION OF A VARISTOR**

**Varistor Microstructure**

The bulk of the varistor between contacts is comprised of ZnO grains of an average size "d" as shown in the schematic model of Figure 3. Resistivity of the ZnO is <0.3 Ω-cm.



**FIGURE 3. SCHEMATIC DEPICTION OF THE MICROSTRUCTURE OF A METAL-OXIDE VARISTOR, GRAINS OF CONDUCTING ZnO (AVERAGE SIZE d) ARE SEPARATED BY INTERGRANULAR BOUNDARIES.**

Designing a varistor for a given nominal varistor voltage, ( $V_N$ ), is basically a matter of selecting the device thickness such that the appropriate number of grains, ( $n$ ), are in series between electrodes. In practice, the varistor material is characterized by a voltage gradient measured across its thickness by a specific volts/mm value. By controlling composition and manufacturing conditions the gradient remains fixed. Because there are practical limits to the range of thicknesses achievable, more than one voltage gradient value is desired. By altering the composition of the metal oxide additives it is possible to change the grain size "d" and achieve the desired result.

A fundamental property of the ZnO varistor is that the voltage drop across a single interface "junction" between grains is nearly constant. Observations over a range of compositional variations and processing conditions show a fixed voltage drop of about 2V-3V per grain boundary junction. Also, the voltage drop does not vary for grains of different sizes. It follows, then, that the varistor voltage will be determined by the thickness of the material and the size of the ZnO grains. The relationship can be stated very simply as follows:

between electrodes

and, varistor thickness,  $D = (n + 1)d$

$$\approx \frac{V_N \times d}{3}$$

where,  $d =$  average grain size

$$R_x = \frac{V}{I}$$

The varistor voltage, ( $V_N$ ), is defined as the voltage across a varistor at the point on its V-I characteristic where the transition ( $v$ ) is complete from the low-level linear region to the highly nonlinear region. For standard measurement purposes, it is arbitrarily defined as the voltage at a current of 1mA. Some typical values of dimensions for Littelfuse Varistors are given in Table 1.

**TABLE 1.**

VARISTOR VOLTAGE	AVERAGE GRAIN SIZE	n	GRADIENT	DEVICE THICKNESS
VOLTS	MICRONS		V/mm AT 1mA	mm
150V <sub>RMS</sub>	20	75	150	1.5
25V <sub>RMS</sub>	80 (Note)	12	39	1.0

NOTE: Low voltage formulation.

**Theory of Operation**

Because of the polycrystalline nature of metal-oxide semiconductor varistors, the physical operation of the device is more complex than that of conventional semiconductors. Intensive measurement has determined many of the device's electrical characteristics, and much effort continues to better define the varistor's operation. However from the user's viewpoint, this is not nearly as important as understanding the basic electrical properties as they relate to device construction.

The key to explaining metal-oxide varistor operation lies in understanding the electronic phenomena occurring near the grain boundaries, or junctions between the ZnO grains. While some of the early theory supposed that electronic tunneling occurred through an insulating second phase layer at the grain boundaries, varistor operation is probably better described by a series-parallel arrangement of semiconducting diodes. In this model, the grain boundaries contain defect states which trap free electrons from the n-type semiconducting ZnO grains, thus forming a space charge depletion layer in the ZnO grains in the region adjacent to the grain boundaries. (See reference notes on the last page of this section).

Evidence for depletion layers in the varistor is shown in Figure 4, where the inverse of the capacitance per boundary squared is plotted against the applied voltage per boundary. This is the same type of behavior observed carrier concentration,  $N$ , was determined to be about  $2 \times 10^{17}$  per  $cm^3$ . In addition, the width of the depletion layer was calculated to be about 1000 Angstrom units. Single junction studies also support the diode model.

It is these depletion layers that block the free flow of carriers and are responsible for the low voltage insulating behavior in the leakage region as depicted in Figure 5. The leakage current is due to the free flow of carriers across

the field lowered barrier, and is thermally activated, at least above about 25°C. For semiconductor abrupt P-N junction diodes. The relationship is:

$$\frac{1}{C^2} = \frac{2(V_b + V)}{q\epsilon s N}$$

Where:

( $V_b$ ) = barrier voltage,

( $V$ ) = applied voltage,

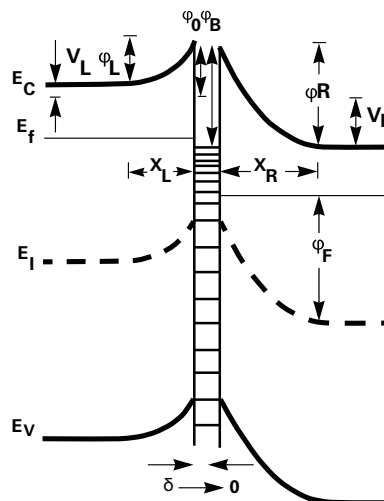
( $q$ ) = electron charge,

( $\epsilon s$ ) = semiconductor permittivity and

( $N$ ) = carrier concentration.

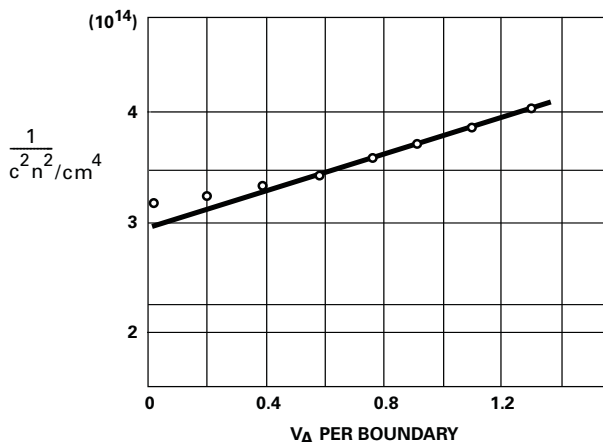
From this relationship the ZnO carrier concentration,  $N$ , was determined to be about  $2 \times 10^{17}$  per  $\text{cm}^3$ .

In addition, the width of the depletion layer was calculated to be about 1000 Angstrom units. Single junction studies also support the diode model.



**FIGURE 5. ENERGY BAND DIAGRAM OF A ZnO-GRAINBOUNDARY-ZnO JUNCTION**

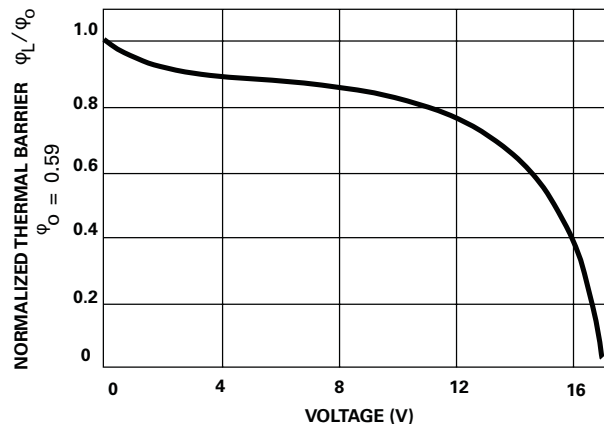
Transport mechanisms in the nonlinear region are very complicated and are still the subject of active research. Most theories draw their inspiration from semiconductor transport theory and is not covered in detail in this document.



**FIGURE 4. CAPACITANCE-VOLTAGE BEHAVIOR OF VARISTOR RESEMBLES A SEMICONDUCTOR ABRUPT-JUNCTION REVERSED BIASED DIODE**  
 $N_d \sim 2 \times 10^{17}/\text{cm}^3$

Figure 5, shows an energy band diagram for a ZnO-grain boundary-ZnO junction. The left-hand grain is forward biased,  $V_L$ , and the right side is reverse biased to  $V_R$ . The depletion layer widths are  $X_L$  and  $X_R$ , and the respective barrier heights are  $f_L$  and  $f_R$ . The zero biased barrier height is  $f_0$ . As the voltage bias is increased,  $f_L$  is decreased and  $f_R$  is increased, leading to a lowering of the barrier and an increase in conduction.

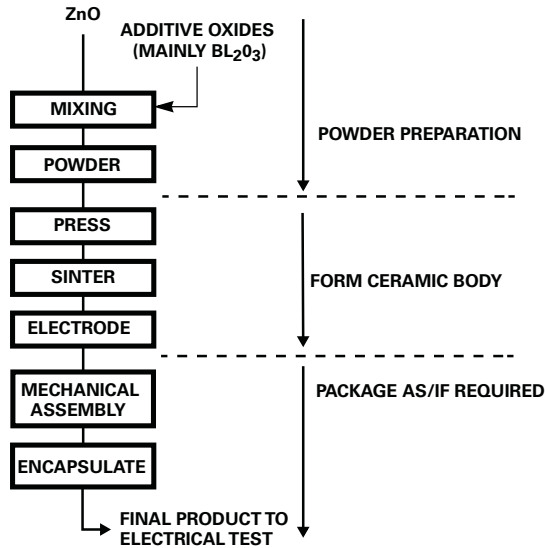
The barrier height  $f_L$  of a low voltage varistor was measured as a function of applied voltage, and is presented in Figure 6. The rapid decrease in the barrier at high voltage represents the onset of nonlinear conduction.



**FIGURE 6. THERMAL BARRIER vs APPLIED VOLTAGE**

**Varistor Construction**

The process of fabricating a Littelfuse Varistor is illustrated in the flow chart of Figure 7. The starting material may differ in the composition of the additive oxides, in order to cover the voltage range of product.



**FIGURE 7. SCHEMATIC FLOW DIAGRAM OF LITTELFUSE VARISTOR FABRICATION**

Device characteristics are determined at the pressing operation. The powder is pressed into a form of predetermined thickness in order to obtain a desired value of nominal voltage. To obtain the desired ratings of peak current and energy capability, the electrode area and mass of the device are varied. The range of diameters obtainable in disc product offerings is listed here:

Nominal Disc Diameter—mm	3	5	7	10	14	20	32	34	40	62
--------------------------	---	---	---	----	----	----	----	----	----	----

Of course, other shapes, such as rectangles, are also possible by simply changing the press dies. Other ceramic fabrication techniques can be used to make different shapes. For example, rods or tubes are made by extruding and cutting to length. After forming, the green (i.e., unfired) parts are placed in a kiln and sintered at peak temperatures in excess of 1200°C. The Bismuth oxide is molten above 825°C, assisting in the initial densification of the polycrystalline ceramic. At higher temperatures, grain growth occurs, forming a structure with controlled grain size.

Electroding is accomplished, for radial and chip devices, by means of thick film silver fired onto the ceramic surface. Wire leads or strap terminals are then soldered in place. A conductive epoxy is used for connecting leads to the axial 3mm discs. For the larger industrial devices (40mm and 60mm diameter discs) the contact material is arc sprayed Aluminum, with an overspray of Copper if necessary to give a solderable surface.

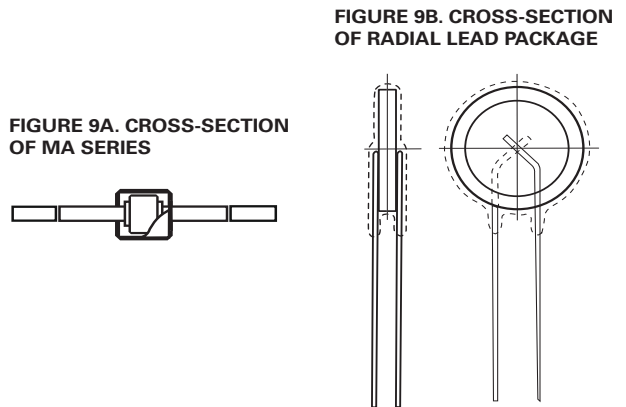
Many encapsulation techniques are used in the assembly of the various Littelfuse Varistor packages. Most radials and some industrial devices (HA Series) are epoxy coated in a fluidized bed, whereas epoxy is “spun” onto the axial device.

Radials are also available with phenolic coatings applied using a wet process. The PA Series package consists of plastic molded around a 20mm disc subassembly. The RA, DA and DB Series devices are all similar in that they all are composed of discs or chips, with tabs or leads, encased in a molded plastic shell filled with epoxy. Different package styles allow variation in energy ratings, as well as in mechanical mounting.

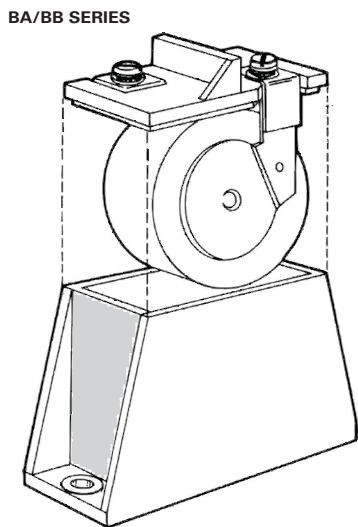
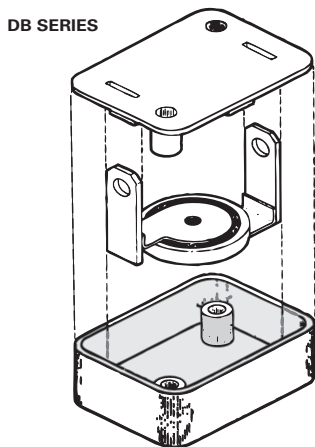
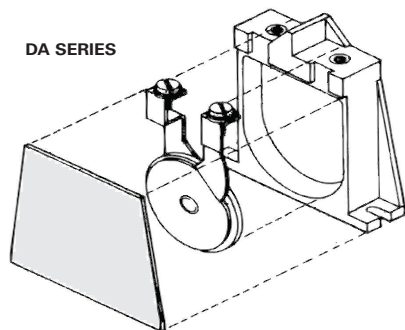
**TABLE 2. BY-TYPE CERAMIC DIMENSIONS**

PACKAGE TYPE	SERIES	CERAMIC DIMENSIONS
Leadless Surface Mount	CH, AUML†, ML†, MLE†, MLN† Series	5mm x 8mm Chip, 0603, 0805, 1206, 1210, 1812, 2220
Axial Leaded	MA Series	3mm Diameter Disc
Radial Leaded	ZA, LA, C-III, TMOV®, iTMOV®, UltraMOV™, TMOV25S® Series	5mm, 7mm, 10mm, 14mm, 20mm Diameter Discs
Boxed, Low Profile	RA Series	5mm x 8mm, 10mm x 16mm, 14 x 22 Chips
Industrial Packages	BA, BB Series DA, DB Series DHB Series HA, HB Series HC, HF Series HG Series	32mm, 40mm Diameter Disc, 34mm Square Disc, 40mm Diameter Disc, 60mm Diameter Disc
Industrial Discs	CA Series	60mm Diameter Discs

Figure 9A, 9B and 9C (next page) show construction details of some Littelfuse varistor packages. Dimensions of the ceramic, by package type, are above in Table 2.

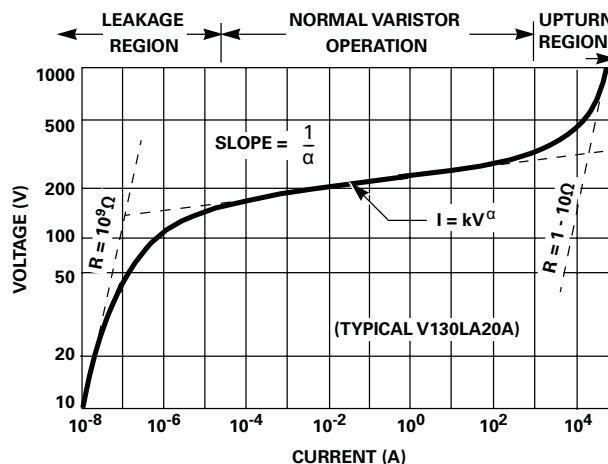


**FIGURE 9C. PICTORIAL VIEW OF HIGH ENERGY DA, DB AND BA/BB SERIES**



## Electrical Characterization Varistor V-I Characteristics

Turning now to the high current upturn region in Figure 10, we see that the V-I behavior approaches an ohmic characteristic. The limiting resistance value depends upon the electrical conductivity of the body of the semiconducting ZnO grains, which have carrier concentrations in the range of  $10^{17}$  to  $10^{18}$  per  $\text{cm}^3$ . This would put the ZnO resistivity below  $0.3\Omega\text{cm}$ .

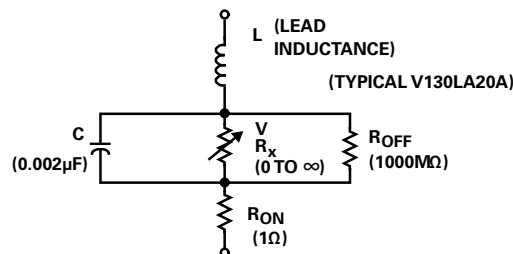


**FIGURE 10. TYPICAL VARISTOR V-I CURVE PLOTTED ON LOG-LOG SCALE**

Varistor electrical characteristics are conveniently displayed using log-log format in order to show the wide range of the V-I curve. The log format also is clearer than a linear representation which tends to exaggerate the nonlinearity in proportion to the current scale chosen. A typical V-I characteristic curve is shown in Figure 10. This plot shows a wider range of current than is normally provided on varistor data sheets in order to illustrate three distinct regions of electrical operation.

## Equivalent Circuit Model

An electrical model for the varistor can be represented by the simplified equivalent circuit of Figure 11.

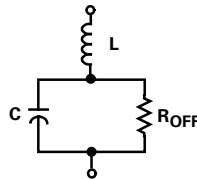


**FIGURE 11. VARISTOR EQUIVALENT CIRCUIT MODEL**



**Leakage Region of Operation**

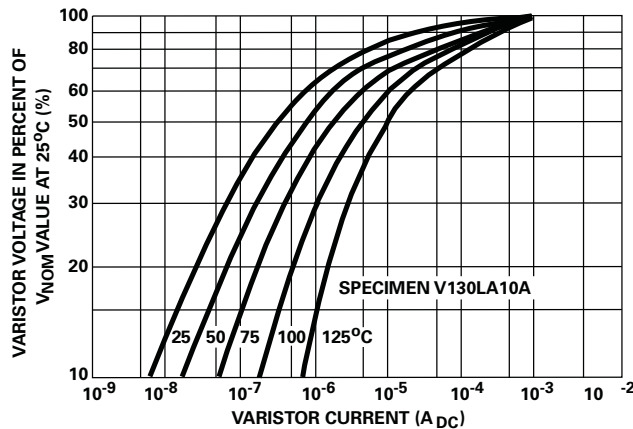
At low current levels, the V-I Curve approaches a linear (ohmic) relationship and shows a significant temperature dependence. The varistor is in a high resistance mode (approaching  $10^9\Omega$ ) and appears as an open circuit. The nonlinear resistance component ( $R_x$ ) can be ignored because ( $R_{OFF}$ ) in parallel will predominate. Also, ( $R_{ON}$ ) will be insignificant compared to ( $R_{OFF}$ ).



**FIGURE 12. EQUIVALENT CIRCUIT AT LOW CURRENTS**

For a given varistor device, capacitance remains approximately constant over a wide range of voltage and frequency in the leakage region. The value of capacitance drops only slightly as voltage is applied to the varistor. As the voltage approaches the nominal varistor voltage, the capacitance decreases. Capacitance remains nearly constant with frequency change up to 100 kHz. Similarly, the change with temperature is small, the 25°C value of capacitance being well with +/-10% from -40°C to +125°C.

The temperature effect of the V-I characteristic curve in the leakage region is shown in Figure 13. A distinct temperature dependence is noted.



**FIGURE 13. TEMPERATURE DEPENDENCE OF THE CHARACTERISTIC CURVE IN THE LEAKAGE REGION**

The relation between the leakage current ( $I$ ) and temperature ( $T$ ) is

$$I = I_0 \epsilon^{-V_B/kT}$$

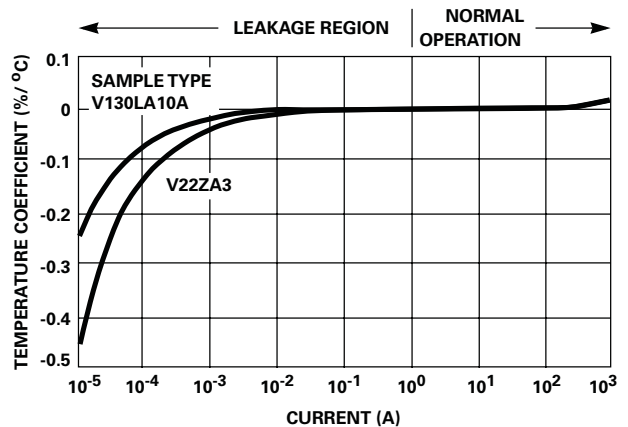
where:  $I_0 = \text{constant}$   
 $k = \text{Boltzmann's Constant}$   
 $V_B = 0.9\text{eV}$

The temperature variation, in effect, corresponds to a change in ( $R_{OFF}$ ). However, ( $R_{OFF}$ ) remains at a high resistance value even at elevated temperatures. For example, it is still in the range of  $10\text{M}\Omega$  to  $100\text{M}\Omega$  at  $125^\circ\text{C}$ .

Although ( $R_{OFF}$ ) is a high resistance it varies with frequency. The relationship is approximately linear with inverse frequency.

If however, the parallel combination of ( $R_{OFF}$ ) and ( $C$ ) is predominantly capacitive at any frequency of interest. This is because the capacitive reactance also varies approximately linearly with  $1/f$ .

At higher currents, at and above the mA range, temperature variation becomes minimal. The plot of the temperature coefficient ( $dV/dT$ ) is given in Figure 14. It should be noted that the temperature coefficient is negative (-) and decreases as current rises. In the clamping voltage range of the varistor ( $I > 1\text{A}$ ), the temperature dependency approaches zero.



**NOTE:** Typical Temperature Coefficient of Voltage vs Current, 14mm Size,  $55^\circ\text{C}$  to  $125^\circ\text{C}$ .

**FIGURE 14. RELATION OF TEMPERATURE COEFFICIENT DV/DT TO VARISTOR CURRENT**

## Nominal Varistor Region of Operation

The varistor characteristic follows the equation:  $I = kV^a$ , where (**k**) is a constant and the exponent (**a**) defines the degree of nonlinearity. Alpha is a figure of merit and can be determined from the slope of the V-I curve or calculated from the formula:

$$\alpha = \frac{\log(I_2/I_1)}{\log(V_2/V_1)}$$

$$= \frac{1}{\log(V_2/V_1)} \text{ for } I_2/I_1 = 1$$

In this region the varistor is conducting and  $R_X$  will predominate over  $C$ ,  $R_{ON}$  and  $R_{OFF}$ .  $R_X$  becomes many orders of magnitude less than  $R_{OFF}$  but remains larger than  $R_{ON}$ .

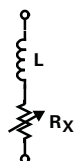


FIGURE 15. EQUIVALENT CIRCUIT AT VARISTOR CONDUCTION

During conduction the varistor voltage remains relatively constant for a change in current of several orders of magnitude. In effect, the device resistance,  $R_X$ , is changing in response to current. This can be observed by examining the static or dynamic resistance as a function of current. The static resistance is defined by:

$$R_X = \frac{V}{I}$$

and the dynamic resistance by:

$$Z_X = \frac{dv}{di} = V/\alpha I = R_X/\alpha$$

Plots of typical resistance values vs current (**I**) are given in Figure 16A and 16B.

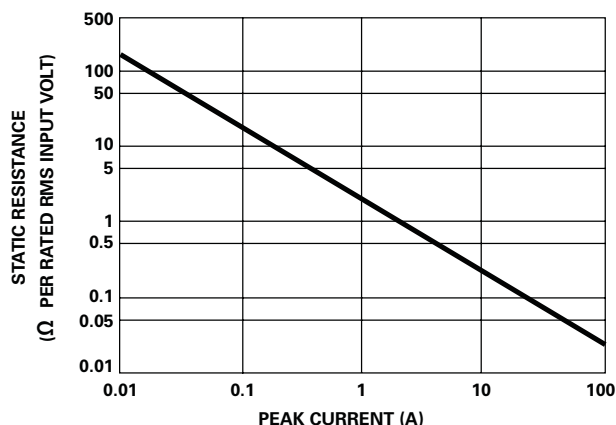


FIGURE 16A.  $R_X$  STATIC VARISTOR RESISTANCE FIGURE

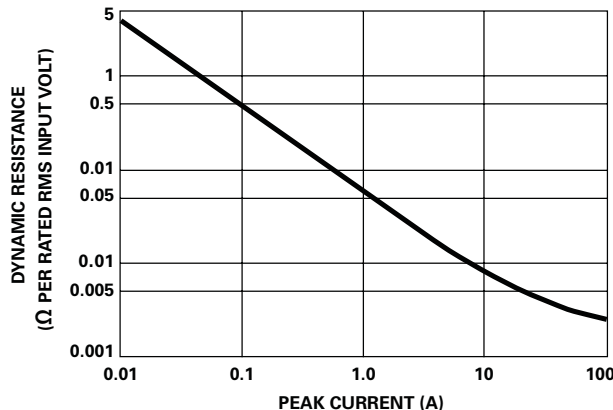


FIGURE 16B.  $Z_X$  DYNAMIC VARISTOR RESISTANCE

## Upturn Region of Operation

At high currents, approaching the maximum rating, the varistor approximates a short-circuit. The curve departs from the nonlinear relation and approaches the value of the material bulk resistance, about 1Ω-10Ω. The upturn takes place as  $R_X$  approaches the value of  $R_{ON}$ . Resistor  $R_{ON}$  represents the bulk resistance of the  $Z_{nO}$  grains. This resistance is linear (which appears as a steeper slope on the log plot) and occurs at currents 50A to 50,000A, depending on the varistor size.

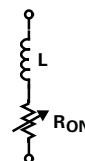
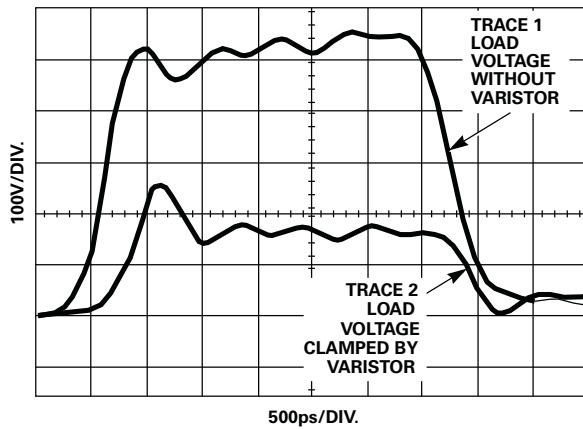


FIGURE 17. EQUIVALENT CIRCUIT AT VARISTOR UPTURN

**Speed of Response and Rate Effects**

The varistor action depends on a conduction mechanism similar to that of other semiconductor devices. For this reason, conduction occurs very rapidly, with no apparent time lag – even into the nanosecond (ns) range. Figure 18, shows a composite photograph of two voltage traces with and without a varistor inserted in a very low inductance impulse generator. The second trace (which is not synchronized with the first, but merely superimposed on the oscilloscope screen) shows that the voltage clamping effect of the varistor occurs in less than **1.0 ns**.



**FIGURE 18. RESPONSE OF A ZnO VARISTOR TO A FAST RISE TIME (500ps) PULSE**

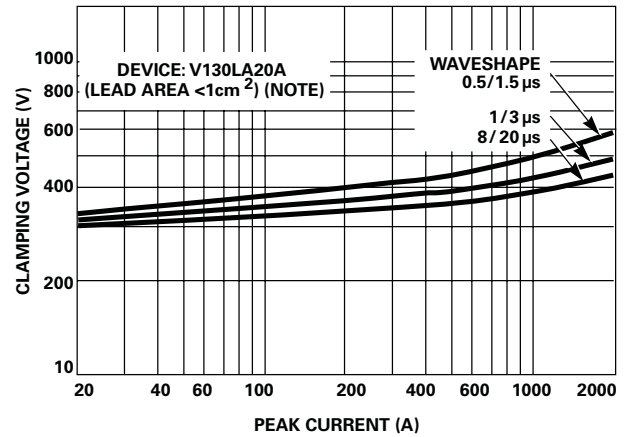
In the conventional lead-mounted devices, the inductance of the leads would completely mask the fast action of the varistor; therefore, the test circuit for Figure 18, required insertion of a small piece of varistor material in a coaxial line to demonstrate the intrinsic varistor response.

Tests made on lead-mounted devices, even with careful attention to minimizing lead length, show that the voltages induced in the loop formed by the leads contribute a substantial part of the voltage appearing across the terminals of a varistor at high current and fast current rise. Fortunately, the currents which can be delivered by a transient source are invariably slower in rise time than the observed voltage transients. The applications most frequently encountered for varistors involve current rise times longer than  $0.5\mu\text{s}$ .

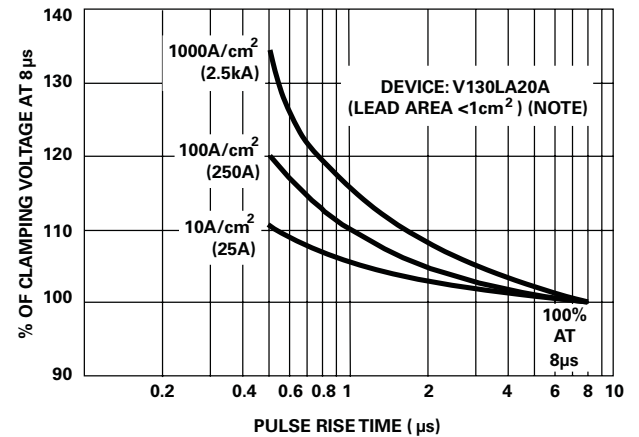
Voltage rate-of-rise is not the best term to use when discussing the response of a varistor to a fast impulse (unlike spark gaps where a finite time is involved in switching from nonconducting to conducting state). The response time of the varistor to the transient current that a circuit can deliver is the appropriate characteristic to consider.

The V-I characteristic of Figure 19A, shows how the response of the varistor is affected by the current waveform. From such data, an "overshoot" effect can be defined as being the relative increase in the maximum voltage appearing across the varistor during a fast current rise, using the conventional  $8/20\mu\text{s}$  current wave as the reference. Figure 19B, shows typical clamping voltage variation with rise time for various current levels.

**FIGURE 19. RESPONSE OF LEAD-MOUNTED VARISTORS TO CURRENT WAVEFORM**



**FIGURE 19A. V-I CHARACTERISTICS FOR VARIOUS CURRENT RISE TIMES**



**FIGURE 19B. OVERSHOOT DEFINED WITH REFERENCE TO THE BASIC  $8/20\mu\text{s}$  CURRENT PULSE**

## How to Connect a Littelfuse Varistor

Transient suppressors can be exposed to high currents for short durations in the nanoseconds to millisecond time frame.

Littelfuse Varistors are connected in parallel to the load, and any voltage drop in the leads to the varistor will reduce its effectiveness. Best results are obtained by using short leads that are close together to reduce induced voltages and a low ohmic resistance to reduce  $I \cdot R$  drops.

### Single Phase

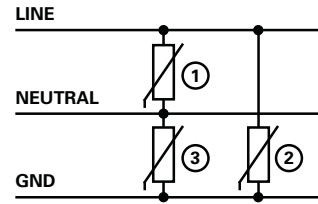


FIGURE 23.

This is the most complete protection one can select, but in many cases only Varistor 1 or Varistor 1 and 2 are selected.

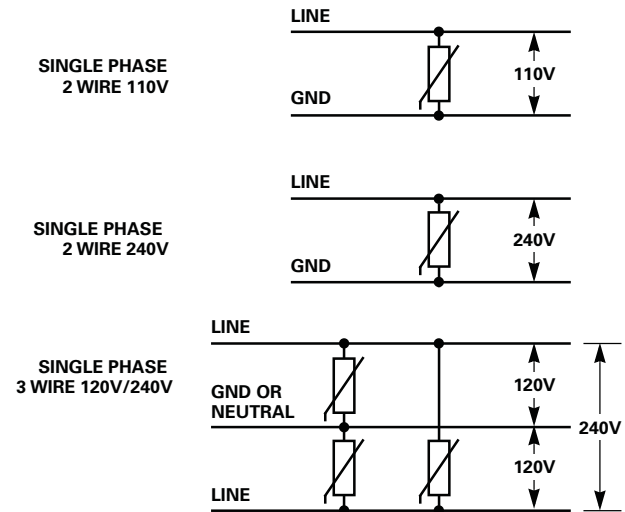
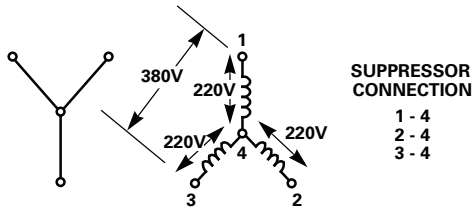
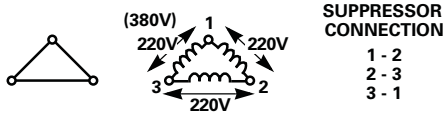


FIGURE 24.

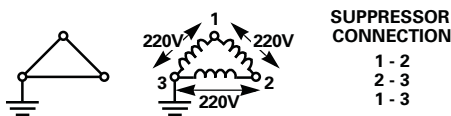
**Three Phase**



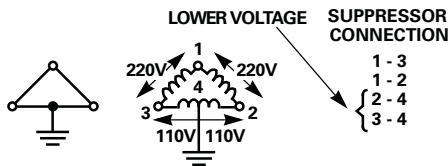
**FIGURE 25A. 3 PHASE 220V/380V, UNGROUNDED**



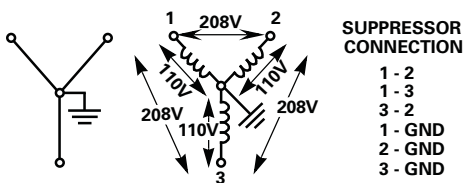
**FIGURE 25B. 3 PHASE 220V OR 380V, UNGROUNDED**



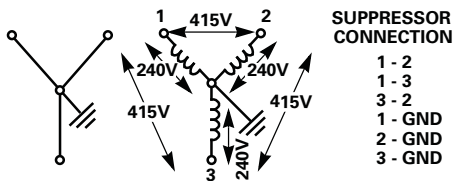
**FIGURE 25C. 3 PHASE 220V, ONE PHASE GROUNDED**



**FIGURE 25D. 3 PHASE 220V**



If only 3 suppressor use 1-GND, 2-GND, 3-GND  
**FIGURE 25E. 3 PHASE 120V/208V, 4-WIRE**



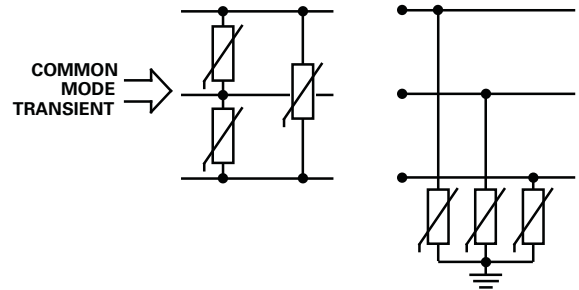
If only 3 suppressor use 1-GND, 2-GND, 3-GND  
**FIGURE 25F. 3 PHASE 240V/415V**

For higher voltages use same connections, but select varistors for the appropriate voltage rating.

**DC Application**

DC applications require connection between plus and minus or plus and ground and minus and ground.

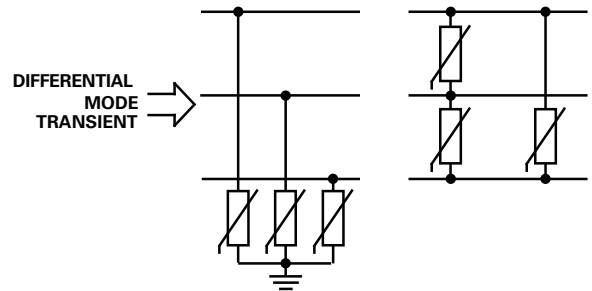
For example, if a transient towards ground exists on all 3 phases (common mode transients) only transient suppressors connected phase to ground would absorb energy. Transient suppressors connected phase to phase would not be effective.



**FIGURE 26A. INCORRECT**      **FIGURE 26B. CORRECT**

**FIGURE 26. COMMON MODE TRANSIENT AND CORRECT SOLUTION**

On the other hand if a differential mode of transient (phase to phase) exists then transient suppressors connected phase to phase would be the correct solution.



**FIGURE 27A. INCORRECT**      **FIGURE 27B. CORRECT**

**FIGURE 27. DIFFERENTIAL MODE TRANSIENT AND CORRECT SOLUTION**

This is just a selection of some of the more important variations in connecting transient suppressors.

The logical approach is to connect the transient suppressor between the points of the potential difference created by the transient. The suppressor will then equalize or reduce these potentials to lower and harmless levels.



## Varistor Terms and Definitions

### Definitions (IEEE Standard C62.33, 1982)

A characteristic is an inherent and measurable property of a device. Such a property may be electrical, mechanical, or thermal, and can be expressed as a value for stated conditions.

A rating is a value which establishes either a limiting capability or a limiting condition (either maximum or minimum) for operation of a device. It is determined for specified values of environment and operation. The ratings indicate a level of stress which may be applied to the device without causing degradation or failure. Varistor symbols are defined on the linear V-I graph illustrated in Figure 20.

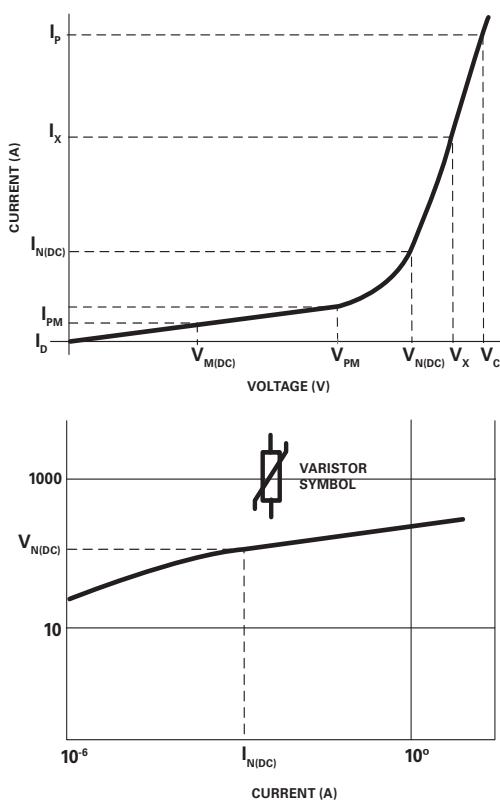


FIGURE 20 – I-V GRAPH ILLUSTRATING SYMBOLS AND DEFINITIONS

### Voltage Clamping Device

A clamping device, such as an MOV, refers to a characteristic in which the effective resistance changes from a high to low state as a function of applied voltage. In its conductive state, a voltage divider action is established between the clamping device and the source impedance of the circuit. Clamping devices are generally “dissipative” devices, converting much of the transient electrical energy to heat.

Choosing the most appropriate suppressor depends upon a balance between the application, its operation, voltage transient threats expected and sensitivity levels of the components requiring protection. Form factor/package style also must be considered.

### Test Waveform

At high current and energy levels, varistor characteristics are measured, of necessity, with an impulse waveform. Shown in Figure 21, is the ANSI Standard C62.1 wave-shape, an exponentially decaying waveform representative of lightning surges and the discharge of stored energy in reactive circuits.

The 8/20 $\mu$ s current wave (8 $\mu$ s rise and 20 $\mu$ s to 50% decay of peak value) is used as a standard, based on industry practices, for the characteristics and ratings described. One exception is the energy rating ( $W_{TM}$ ), where a longer waveform of 10/1000 $\mu$ s is used. This condition is more representative of the high energy surges usually experienced from inductive discharge of motors and transformers. Varistors are rated for a maximum pulse energy surge that results in a varistor voltage ( $V_N$ ) shift of less than +/-10% from initial value.

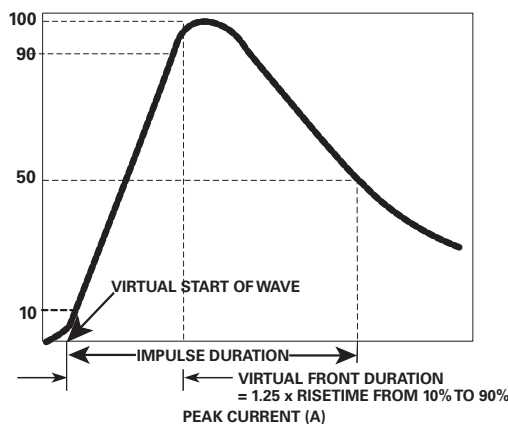


FIGURE 21. DEFINITION OF PULSE CURRENT WAVEFORM

### Power Dissipation Ratings

When transients occur in rapid succession the average power dissipation is the energy  $W_{TM}$  (watt-seconds) per pulse times the number of pulses per second. The power so developed must be within the specifications shown in the Device Ratings and Characteristics Table for the specific device. Certain parameters must be derated at high temperatures.

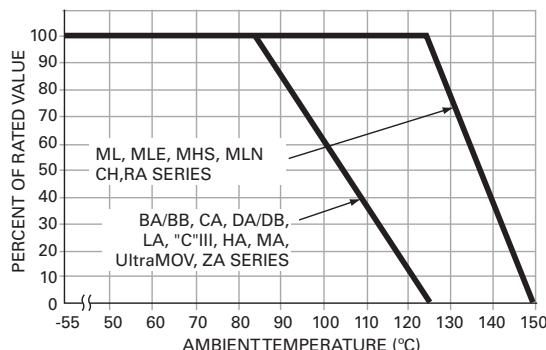


FIGURE 22. DEVICE RATINGS AND CHARACTERISTICS

**TABLE 3. VARISTOR CHARACTERISTICS (IEEE STANDARD C62.33-1982 SUBSECTION 2.3 AND 2.4)**

Terms and Descriptions	Symbol
<b>Clamping Voltage.</b> Peak voltage across the varistor measured under conditions of a specified peak $V_C$ pulse current and specified waveform. NOTE: Peak voltage and peak currents are not necessarily coincidental in time.	$V_C$
<b>Rated Peak Single Pulse Transient Currents (Varistor).</b> Maximum peak current which may be applied for a single 8/20 $\mu$ s impulse, with rated line voltage also applied, without causing device failure.	$I_{TM}$
<b>Lifetime Rated Pulse Currents (Varistor).</b> Derated values of $I_{TM}$ for impulse durations exceeding that of an 8/20 $\mu$ s waveshape, and for multiple pulses which may be applied over device rated lifetime.	-
<b>Rated RMS Voltage (Varistor).</b> Maximum continuous sinusoidal RMS voltage which may be applied.	$V_{M(AC)}$
<b>Rated DC Voltage (Varistor).</b> Maximum continuous DC voltage which may be applied.	$V_{M(DC)}$
<b>DC Standby Current (Varistor).</b> Varistor current measured at rated voltage, $V_{M(DC)}$ .	$I_D$
For certain applications, some of the following terms may be useful.	
<b>Nominal Varistor Voltage.</b> Voltage across the varistor measured at a specified pulsed DC current, $I_{N(DC)}$ , of specific duration. $I_{N(DC)}$ of specific duration. $I_{N(DC)}$ is specified by the varistor manufacturer.	$V_{N(DC)}$
<b>Peak Nominal Varistor Voltage.</b> Voltage across the varistor measured at a specified peak AC current, $I_{N(AC)}$ , of specific duration. $I_{N(AC)}$ is specified by the varistor manufacturer.	$V_{N(AC)}$
<b>Rated Recurrent Peak Voltage (Varistor).</b> Maximum recurrent peak voltage which may be applied for a specified duty cycle and waveform.	$V_{PM}$
<b>Rated Single Pulse Transient Energy (Varistor).</b> Energy which may be dissipated for a single impulse of maximum rated current at a specified waveshape, with rated RMS voltage or rated DC voltage also applied, without causing device failure.	$W_{TM}$
<b>Rated Transient Average Power Dissipation (Varistor).</b> Maximum average power which may be dissipated due to a group of pulses occurring within a specified isolated time period, without causing device failure.	
<b>Varistor Voltage.</b> Voltage across the varistor measured at a given current, $I_X$ .	$V_X$
<b>Voltage Clamping Ratio (Varistor).</b> A figure of merit measure of the varistor clamping effectiveness as defined by the symbols $(V_C) \div (V_{M(AC)})$ , $(V_C) \div (V_{M(DC)})$ .	$V_C / V_{PM}$
<b>Nonlinear Exponent.</b> A measure of varistor nonlinearity between two given operating currents, $I_1$ and $I_2$ , as described by $I = kV^a$ where $k$ is a device constant, $I_1 \leq I \leq I_2$ , and $a_{12} = (\log I_2 / I_1) \div (\log V_2 / V_1)$	$a$
<b>Dynamic Impedance (Varistor).</b> A measure of small signal impedance at a given operating point as defined by: $Z_X = (dV_X) \div (dI_X)$	$Z_X$
<b>Resistance (Varistor).</b> Static resistance of the varistor at a given operating point as defined by: $R_X = (V_X) \div (I_X)$	$R_X$
<b>Capacitance (Varistor).</b> Capacitance between the two terminals of the varistor measured at C specified frequency and bias.	$C$
<b>AC Standby Power (Varistor).</b> Varistor AC power dissipation measured at rated RMS voltage $V_{M(AC)}$ .	$P_D$
<b>Voltage Overshoot (Varistor).</b> The excess voltage above the clamping voltage of the device for a given current that occurs when current waves of less than 8 $\mu$ s virtual front duration are applied. This value may be expressed as a % of the clamping voltage ( $V_C$ ) for an 8/20 current wave.	$V_{OS}$
<b>Response Time (Varistor).</b> The time between the point at which the wave exceeds the clamping voltage level ( $V_C$ ) and the peak of the voltage overshoot. For the purpose of this definition, clamping voltage as defined with an 8/20 $\mu$ s current waveform of the same peak current amplitude as the waveform used for this response time.	-
<b>Overshoot Duration (Varistor).</b> The time between the point voltage level ( $V_C$ ) and the point at which the voltage overshoot has decayed to 50% of its peak. For the purpose of this definition, clamping voltage is defined with an 8/20 $\mu$ s current waveform of the same peak current amplitude as the waveform used for this overshoot duration.	-

## Agency Standards

Littelfuse Varistors have been investigated and evaluated and are certified, recognized or otherwise approved with pertinent safety or standards organizations. Following are descriptions of some of the applicable standards.

### Underwriters Laboratories (UL)

UL writes "Standards" to which products are investigated. Upon completion of the tests, a "Listing" or "Recognition" to the standard with conditions of acceptability is given under a unique file number. All of Littelfuse applicable Varistors are in the "Recognized Components" category to one or more of the following standards:

- **UL1449** Transient Voltage Suppressors.
- **UL1414** Across the Line Capacitors, Antenna Coupling and Line By-Pass Capacitors for Radio and Television Type Appliances.
- **UL497B** Protectors for Data and Communication and Fire Alarm Circuits.

(Note that the terms "Approved" or "Certified" are not correct in referring to devices listed or recognized by UL.)

### VDE (Verband Deutscher Electrotechniker)

Based in Germany, this is the Association of German Engineers who develop specific safety standards and test requirements. VDE tests and certifies devices or products, assigning a license number. Littelfuse Radial Varistors are currently certified under license number 104846-E having successfully met CECC standard 42 201-006 (issue 1/1996).

### CECC (CENELEC Electronic Components Committee)

Based in Brussels, CENELEC is the "European Committee for Electrotechnical Standardization" which provides harmonized standards for the European Community based upon IEC and ISO publications. All Littelfuse Radial Varistor Series are approved to Specification 42201-006.

### CSA (Canadian Standards Association)

Based in Canada, this regulatory agency writes standards to which it conducts product safety tests. Upon successful completion, a file number is established, the product is "Certified" and may display the CSA logo as indication. Specific Littelfuse Varistors have been tested to CSA Standard number 22.2, No.1-94. Littelfuse file number is LR91788.

### NSAI (National Standards Authority of Ireland)

This Irish testing organization is facilitated and authorized to evaluate products to the various Euro Norms CECC specifications thereby granting declarations of conformity.

### Electrostatic Discharge (ESD) Standards

Several industry standards and specifications exist that are used to qualify and quantify ESD events. Since many circuits or systems must demonstrate immunity to ESD, these standards are often incorporated in the testing of ESD capability. Of particular concern is the immunity level for semiconductors. The "standards" include Human Body Model (HBM) to MIL-STD-883, Machine Model (MM) such as EIAJ IC121, and Charged Device Model (CDM) such as US ESD DS 5.3. The Human Body Model, Machine Model and Charged Device Model primarily relate to manufacturing and testing process of an IC.

One of the most severe is IEC 61000-4-2 from the International Electrotechnical Commission (IEC) and referenced in the EMC directive. Level 4 of this test method is the highest level, subjecting the device under test to 8kV contact discharge method (preferred) and/or 15kV air discharge. Each Littelfuse technology is designed for this level. The recommended types are the Silicon based Silicon Protection Array SP05x and SP7X, the polymeric VVM based PulseGuard® Suppressor, and the ML, MLE, MHS or MLN Multilayers.

The designer should be aware of the ESD ratings of the semiconductors used in the circuit. For example, semiconductor manufacturers that rate their devices to MIL-STD-883 to 2kV may not pass 2kV when subjected to the more difficult IEC test method (150pF / 330Ω instead of 100pF / 1500Ω). Additionally, even if semiconductors do meet some level of ESD immunity to IEC standards, that does not imply that additional ESD suppression is not required. Real world ESD transients can exceed the peak currents and voltages as defined by the standards and can have much faster rise times.

IEC 61000-4-2 consists of four test severity levels of ESD immunity using both a Contact Discharge and Air Discharge test method. The EUT or DUT may be subjected to increasing levels of severity until failure. Or, a particular level of immunity may be prescribed for EM compatibility of an end product.

For more information about the IEC 61000-4-2 test method, see Application Note AN9734, "IEC Electromagnetic Compatibility Standards for Industrial Process Measurement and Control Equipment."

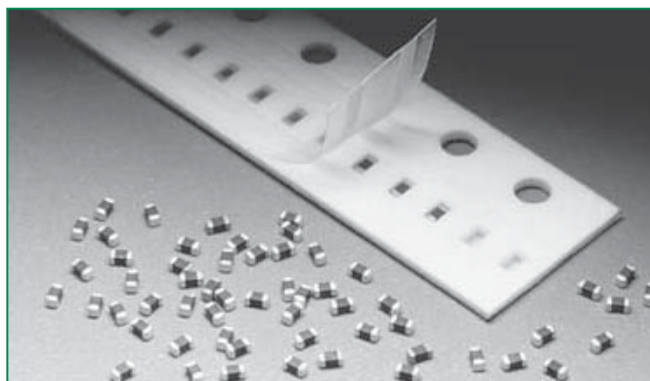
AGENCY AND SPECIFICATION NUMBER								
SERIES	PRODUCT CLASS	UL	UL	UL	CSA	VDE	NSAI	DSSC
		UL1449	UL1414	UL497B	22.2-1	CECC Spec 42201-006	CECC Spec 42201-006	MIL, QPL
BA	Industrial/MOV	X						
DA/DB	Industrial/MOV	X						
HA, HC	Industrial/Hi Energy/MOV	X	Note 1		Note 1			
LA	Radial/MOV	X	X	X	X	X	X	
BB	Industrial/MOV							
DA/DB	Industrial/MOV	X						
HA	Industrial/MOV	X			X			
HB, HF, HG, DHB,	Industrial/MOV	X	Note 1		Note 1			
TMOV® 34mm	Industrial/Hi Energy/MOV	X						
CH	Surface Mount/MOV	Note 1		X				
ZA	Radial Leaded	Note 1		X		Note 1	Note 1	
RA	Special Radial	X	Note 1	X	X			
TMOV® 14mm and 20mm	Radial/MOV	X	X		Note 1	X	X	
CA60 Disk	Industrial Hi Energy							
TMOV®25mm	Radial/MOV	Pending						
UltraMOV™	Radial Leaded	X	X		X	X	X	
25S UltraMOV™	Radial Leaded	Pending			Pending	Pending	Pending	
C-III	Radial Leaded	X			X			
MA	Special Axial							
HI REL, QPL Parts	Special Radial							X

**NOTES:**

- 1) Applies to certain models only, see specific product Data Sheet for details.
- Not all types within each series are applicable for recognition.
- Not all Littelfuse Varistors products require safety listing due to their low operating voltage and intended applications. These includes ML, MLN, MLE, MHS leadless chips.
- The information provided is accurate at the time of printing. Changes can occur based upon new products offered by Littelfuse, revision of an existing standard, or introduction of a new standard or agency requirement. Contact Littelfuse Sales for latest information.



**RoHS MHS Varistor Series**



**Size Table**

Metric	EIA
1005	0402
1608	0603

**Applications**

- Data, Diagnostic I/O Ports
- Universal Serial Bus (USB)
- Video & Audio Ports
- Portable/Hand-Held Products
- Mobile Communications
- Computer/DSP Products
- Industrial Instruments Including Medical

**Description**

The Multilayer High-Speed MHS Series is a very-low capacitance extension to the Littelfuse ML family of transient voltage surge suppression devices available in an 0402 and 0603-size surface mount chip.

The MHS Series provides protection from ESD and EFT in high-speed data line and other high frequency applications. The low capacitance of the MHS Series permits usage in analog or digital circuits where it will not attenuate or distort the desired signal or data.

Their small size is ideal for high-density printed circuit boards, being typically applied to protect intergrated circuits and other sensitive components. They are particularly well suited to suppress ESD events including those specified in IEC 61000-4-2 or other standards used for Electromagnetic Compliance (EMC) testing.

The MHS Series is manufactured from semiconducting ceramics and is supplied in a leadless, surface mount package. The MHS Series is also compatible with modern reflow and wave soldering processes.

Littelfuse Inc. manufactures other multilayer varistor series products, see the ML, MLE, MLN and AUML Series data sheets.

**Features**

- AEC - Q200 compliant
- RoHS compliant
- 3pF, 12pF, and 22pF capacitance versions suitable for high-speed data rate lines
- ESD rated to IEC 61000-4-2 (Level 4)
- EFT/B rated to IEC 61000-4-4 (Level 4)
- Low leakage currents
- -55°C to +125°C operating temp. range
- Inherently bi-directional

**Absolute Maximum Ratings**

• For ratings of individual members of a series, see device ratings and specifications table.

Continuous	MHS Series	Units
Steady State Applied Voltage:		
DC Voltage Range ( $V_{MDC}$ ) :	V0402/0603MHS03	≤ 42 V
	V0402/0603MHS12	≤ 18 V
	V0402/0603MHS22	≤ 09 V
Operating Ambient Temperature Range ( $T_A$ )	-55 to +125	°C
Storage Temperature Range ( $T_{STG}$ )	-55 to +150	°C



### Device Ratings and Specifications

Part Number	Performance Specifications (25 °C)							
	Maximum Clamping Voltage At 1A (8X20 $\mu$ s)	Maximum ESD Clamp Voltage (Note 1)		Typical Leakage Current at Specified DC Voltage		Typical Capacitance at 1MHz (1V p-p)		Typical Inductance (from Impedance Analysis)
		8kV Contact (Note 2)	15kV AIR (Note 3)	3.5V	5.5V	C (Note 4)		L
		Clamp	Clamp	P	I <sub>L</sub>	MIN	MAX	
(V <sub>c</sub> )	(V)	(V)	( $\mu$ A)	( $\mu$ A)	(pF)	(pF)	(nH)	
V0402MHS03N	135	<300	<400	0.5	1.00	1	6 (Note 5)	<1.0
V0603MHS03N	135	<300	<400	0.5	1.00	1	6	<1.0
V0402MHS12N	55	<125	<160	0.5	1.00	8	16	<1.0
V0603MHS12N	55	<125	<160	0.5	1.00	8	16	<1.0
V0402MHS22N	30	<125	<160	0.5	1.00	15	29	<1.0
V0603MHS22N	30	<65	<100	0.5	1.00	15	29	<1.0

**NOTES:**

1. Tested to IEC-61000-4-2 Human Body Model (HBM) discharge test circuit.
2. Direct discharge to device terminals (IEC preferred test method).
3. Corona discharge through air (represents actual ESD event).
4. Capacitance may be customized, contact your Littelfuse Sales Representative.
5. V0402MHS03 available with Min: 2pF, Max 5pF as 'R' packing option, i.e. V0402MHS03NR.

### Peak Current and Energy Derating Curve

For applications exceeding 125°C ambient temperature, the peak surge current and energy ratings must be reduced as shown below.

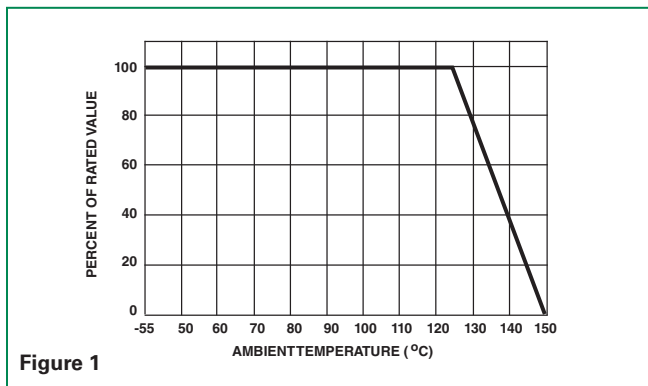


Figure 1

### Standby Current at Normalized Varistor Voltage and Temperature

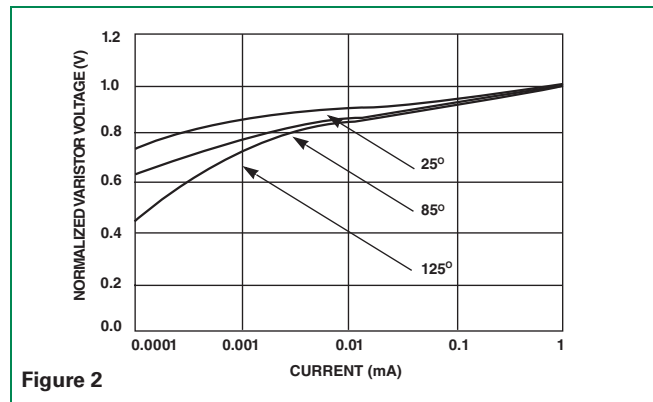


Figure 2

### Nominal Voltage Stability to Multiple ESD Impulses (8kV Contact Discharges per IEC 61000-4-2)

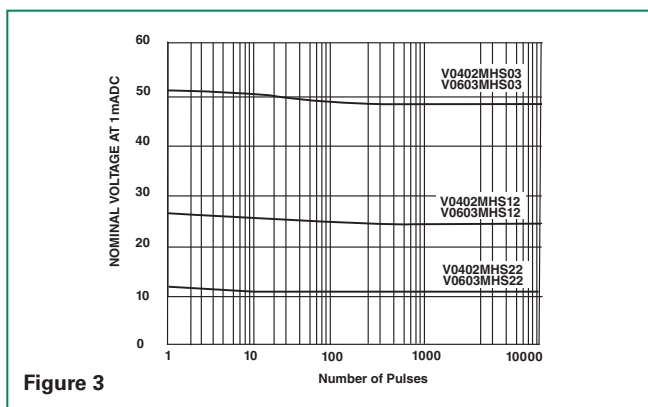


Figure 3

### Insertion Loss (S21) Characteristics

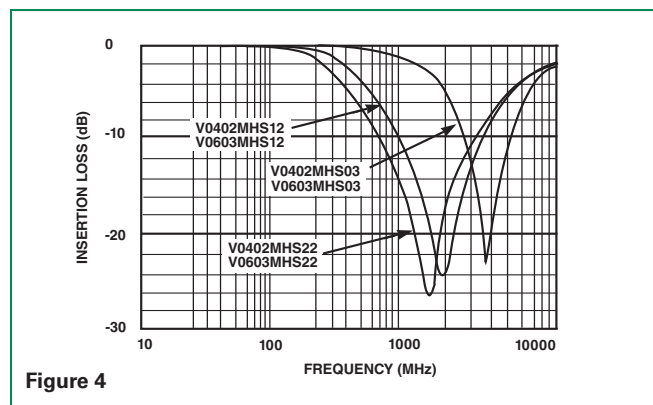
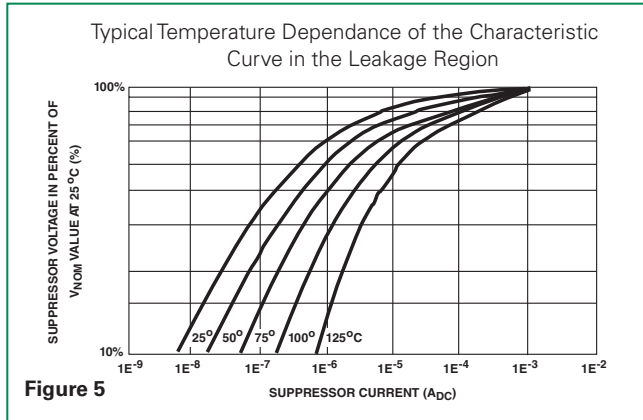


Figure 4

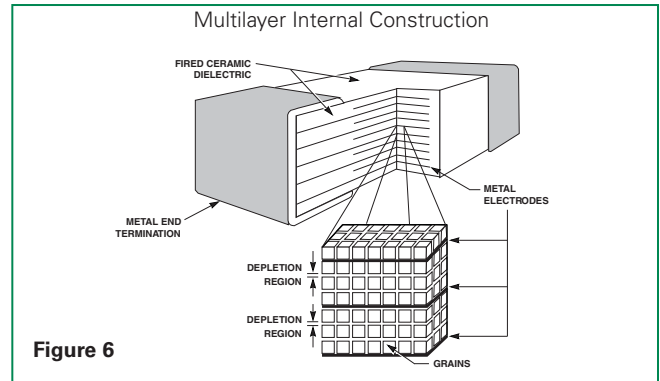
### Device Characteristics

At low current levels, the V-I curve of the multilayer transient voltage suppressor approaches a linear (ohmic) relationship and shows a temperature dependent effect. At or below the maximum working voltage, the suppressor is in a high resistance model (approaching  $10^6\Omega$  at its maximum rated working voltage). Leakage currents at maximum rated voltage are below  $100\mu\text{A}$ , typically  $25\mu\text{A}$ ; for 0402 size below  $20\mu\text{A}$ , typically  $5\mu\text{A}$ .



### Speed of Response

The Multilayer Suppressor is a leadless device. Its response time is not limited by the parasitic lead inductances found in other surface mount packages. The response time of the  $Z_{\text{N}}\text{O}$  dielectric material is less than 1ns and the MLE can clamp very fast dV/dT events such as ESD. Additionally, in "real world" applications, the associated circuit wiring is often the greatest factor effecting speed of response. Therefore, transient suppressor placement within a circuit can be considered important in certain instances.



MHS Series

### Lead (Pb) Soldering Recommendations

The principal techniques used for the soldering of components in surface mount technology are IR Re-flow and Wave soldering. Typical profiles are shown on the right.

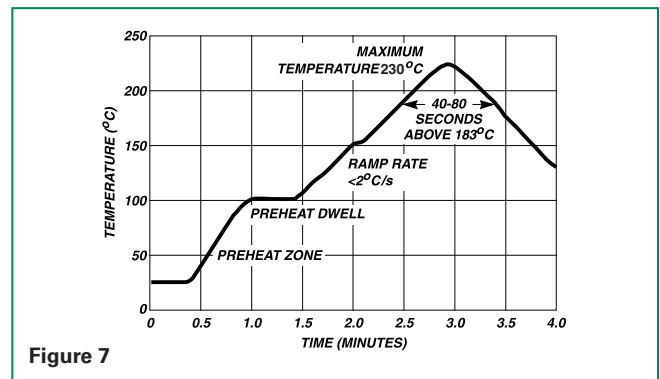
The recommended solder for the MHS suppressor is a 62/36/2 (Sn/Pb/Ag), 60/40 (Sn/Pb) or 63/37 (Sn/Pb). Littelfuse also recommends an RMA solder flux.

Wave soldering is the most strenuous of the processes. To avoid the possibility of generating stresses due to thermal shock, a preheat stage in the soldering process is recommended, and the peak temperature of the solder process should be rigidly controlled.

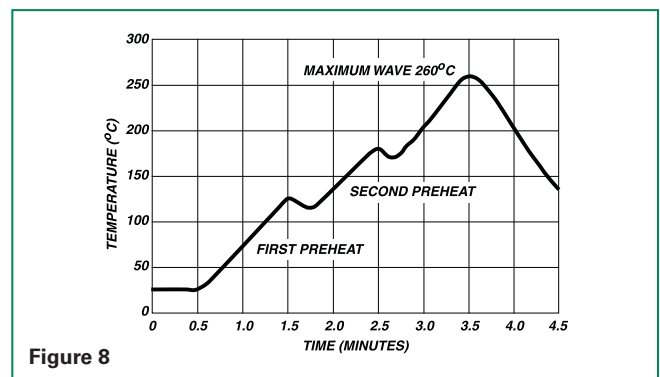
When using a reflow process, care should be taken to ensure that the MHS chip is not subjected to a thermal gradient steeper than 4 degrees per second; the ideal gradient being 2 degrees per second. During the soldering process, preheating to within 100 degrees of the solder's peak temperature is essential to minimize thermal shock.

Once the soldering process has been completed, it is still necessary to ensure that any further thermal shocks are avoided. One possible cause of thermal shock is hot printed circuit boards being removed from the solder process and subjected to cleaning solvents at room temperature. The boards must be allowed to cool gradually to less than 50°C before cleaning.

### Reflow Solder Profile



### Wave Solder Profile



### Lead-free (Pb-free) Soldering Recommendations

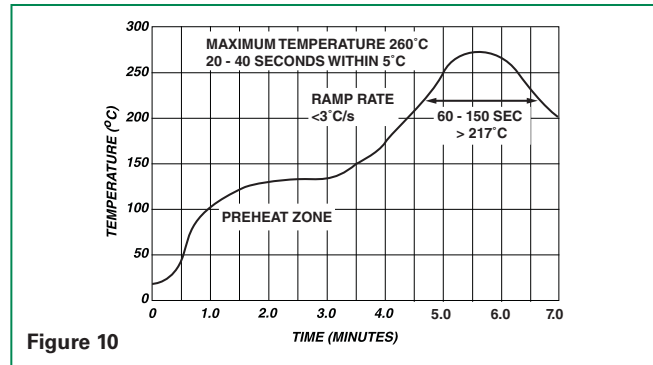
Littelfuse offers the Nickel Barrier Termination finish for the optimum Lead-free solder performance.

The preferred solder is 96.5/3.0/0.5 (SnAgCu) with an RMA flux, but there is a wide selection of pastes and fluxes available with which the Nickel Barrier parts should be compatible.

The reflow profile must be constrained by the maximums in the Lead-free Reflow Profile. For Lead-free wave soldering, the Wave Solder Profile still applies.

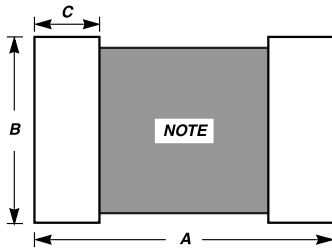
Note: the Lead-free paste, flux and profile were used for evaluation purposes by Littelfuse, based upon industry standards and practices. There are multiple choices of all three available, it is advised that the customer explores the optimum combination for their process as processes vary considerably from site to site.

### Lead-free Re-flow Profile



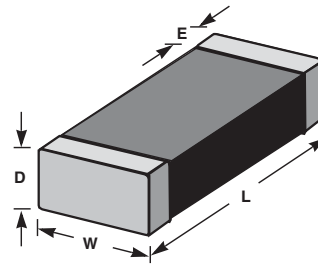
### Product Dimensions (mm)

PAD LAYOUT DIMENSIONS



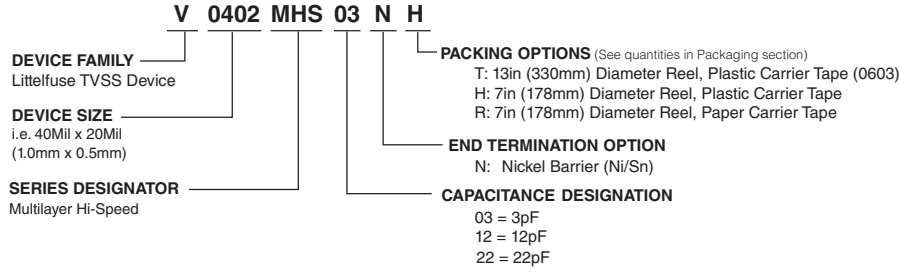
Note: Avoid metal runs in this area, parts are not recommended for use in applications using Silver (Ag) epoxy paste.

CHIP LAYOUT DIMENSIONS



Dimension	0402 Size		0603 Size	
	IN	MM	IN	MM
<b>A</b>	0.067	1.700	0.100	2.540
<b>B</b>	0.020	0.510	0.030	0.760
<b>C</b>	0.024	0.610	0.035	0.890
<b>D (max.)</b>	0.024	0.600	0.040	1.000
<b>E</b>	0.10 +/- 0.006	0.25 +/- 0.15	0.015 +/- 0.008	0.4 +/- 0.2
<b>L</b>	0.039 +/- 0.004	1.00 +/- 0.10	0.063 +/- 0.006	1.6 +/- 0.15
<b>W</b>	0.020 +/- 0.004	0.50 +/- 0.10	0.032 +/- 0.006	0.8 +/- 0.15

### Part Numbering System

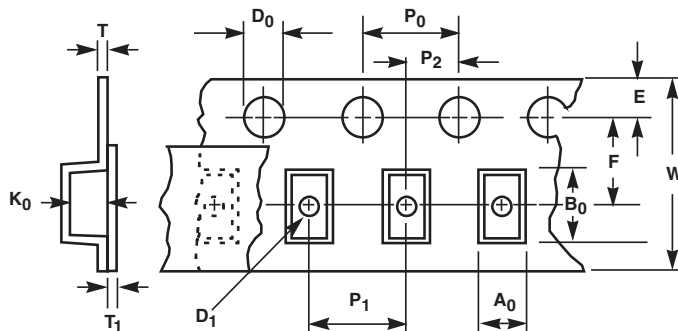


### Packaging\*

Device Size	Quantity		
	13 Inch Reel ("T" Option)	7 Inch Reel ("H" Option)	7 Inch Reel ("R" Option)
0603	10,000	2,500	4,000
0402	N/A	N/A	10,000

\*(Packaging) It is recommended that parts be kept in the sealed bag provided and that parts be used as soon as possible when removed from bags.

### Tape and Reel Specifications



Symbol	Description	Dimensions in Millimeters	
		0402 Size	0603 Size
$A_0$	Width of Cavity	Dependent on Chip Size to Minimize Rotation.	
$B_0$	Length of Cavity	Dependent on Chip Size to Minimize Rotation.	
$K_0$	Depth of Cavity	Dependent on Chip Size to Minimize Rotation.	
$W$	Width of Tape	8 +/- 0.2	8 +/- 0.3
$F$	Distance Between Drive Hole Centers and Cavity Centers	3.5 +/- .05	3.5 +/- .05
$E$	Distance Between Drive Hole Centers and Tape Edge	1.75 +/- 0.1	1.75 +/- 0.1
$P_1$	Distance Between Cavity Centers	2 +/- 0.05	4 +/- 0.1
$P_2$	Axial Drive Distance Between Drive Hole Centers & Cavity Centers	2 +/- 0.1	2 +/- 0.1
$P_0$	Axial Drive Distance Between Drive Hole Centers	4 +/- 0.1	4 +/- 0.1
$D_0$	Drive Hole Diameter	1.55 +/- 0.05	1.55 +/- 0.05
$D_1$	Diameter of Cavity Piercing	N/A	1.05 +/- 0.05
$T_1$	Top Tape Thickness	0.1 Max	0.1 Max
$T$	Nominal Carrier Tape Thickness	1.1	1.1

Notes:

- Conforms to EIA-481-1, Revision A
- Can be supplied to IEC publication 286-3

©2009 Littelfuse, Inc.

Specifications are subject to change without notice.  
Please refer to [www.littelfuse.com/series/MHS.html](http://www.littelfuse.com/series/MHS.html) for current information.



### RoHS MLE Varistor Series



#### Size Table

Metric	EIA
1005	0402
1608	0603
2012	0805
3216	1206

#### Applications

- Protection of components and circuits sensitive to ESD Transients occurring on power supplies, control and signal lines
- Suppression of ESD events such as specified in IEC-61000-4-2 or MIL-STD-883C Method-3015.7, for electromagnetic compliance (EMC)
- Used in mobile communications, computer/EDP products, medical products, hand held/portable devices, industrial equipment, including diagnostic port protection and I/O interfaces

#### Description

The MLE Series family of transient voltage suppression devices are based on the Littelfuse multilayer fabrication technology. These components are designed to suppress ESD events, including those specified in IEC 61000-4-2 or other standards used for Electromagnetic Compliance testing. The MLE Series is typically applied to protect integrated circuits and other components at the circuit board level operating at  $18V_{DC}$  or less.

The fabrication method and materials of these devices result in capacitance characteristics suitable for high frequency attenuation/low-pass filter circuit functions, thereby providing suppression and filtering in a single device.

The MLE Series is manufactured from semiconducting ceramics and is supplied in a leadless, surface mount package. The MLE Series is compatible with modern reflow and wave soldering procedures.

Littelfuse Inc. manufactures other Multilayer Series products. See the ML Series data sheet for higher energy/peak current transient applications. See the AUML Series for automotive applications and the MLN Quad Array. For high-speed applications see the MHS Series.

#### Features

- AEC - Q200 compliant
- RoHS Compliant
- Rated for ESD (IEC-61000-4-2)
- Characterized for impedance and capacitance
- 55°C to +125°C operating temp. range
- Leadless 0402, 0603, 0805, and 1206 sizes
- Operating voltages up to  $18V_{M(DC)}$
- Multilayer ceramic construction technology

#### Absolute Maximum Ratings

- For ratings of individual members of a series, see device ratings and specifications table.

Continuous	MLE Series	Units
Steady State Applied Voltage:		
DC Voltage Range ( $V_{M(DC)}$ )	≤18	V
Operating Ambient Temperature Range ( $T_A$ )	-55 to +125	°C
Storage Temperature Range ( $T_{STG}$ )	-55 to +150	C



### Device Ratings and Specifications

Part Number	Max Continuous Working Voltage -55°C to 125°C	Performance Specifications (25°C)					
		Nominal Voltage		Maximum Clamping Voltage at Specified Current (8/20µs) $V_C$	Maximum ESD Clamp Voltage (Note 2)		Typical Capacitance at 1MHz (pF)
		$V_{M(DC)}$ (Note 1) (V)	$V_{NOM}$ at 1mA DC MIN (V)   MAX (V)		8kV Contact (Note 3) (V)	15kV Air (Note 4) Clamp (V)	
V18MLE0402N	18	22	28	50 at 1A	<125	<110	<55
V18MLE0603N	18	22	28	50 at 1A	<75	<110	<125
V18MLE0603LN	18	22	28	50 at 1A	<100	<140	<100
V18MLE0805N	18	22	28	50 at 1A	<70	<75	<500
V18MLE0805LN	18	22	28	50 at 1A	<75	<135	<100
V18MLE1206N	18	22	28	50 at 1A	<65	<65	<1700

**NOTES:**

- For applications of 18V<sub>DC</sub> or less. Higher voltages available, contact your Littelfuse Sales Representative.
- Tested with IEC-61000-4-2 Human Body Model (HBM) discharge test circuit.
- Direct discharge to device terminals (IEC preferred test method).
- Corona discharge through air (represents actual ESD event).
- Capacitance may be customized, contact your Littelfuse Sales Representative.
- Leakage current ratings are at 18V<sub>DC</sub> and 25µA maximum.

### Peak Current and Energy Derating Curve

For applications exceeding 125°C ambient temperature, the peak surge current and energy ratings must be reduced as shown below.

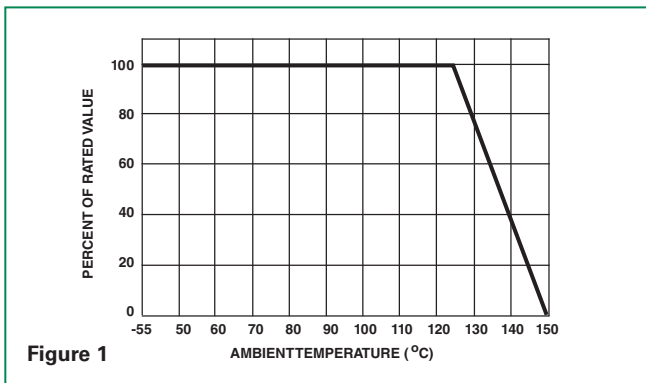


Figure 1

### Nominal Voltage Stability to Multiple ESD Impulses (8kV Contact Discharges per IEC 61000-4-2)

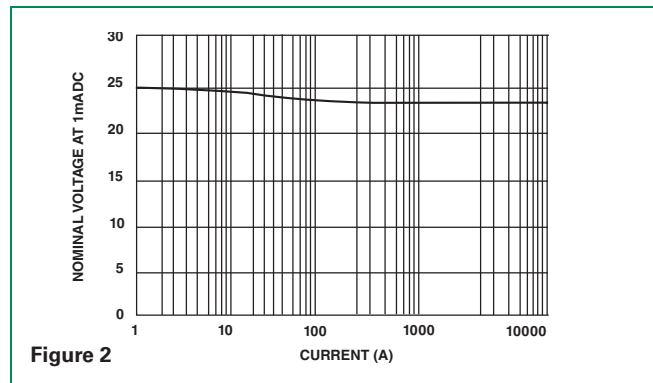


Figure 2

### Standby Current at Normalized Varistor Voltage and Temperature

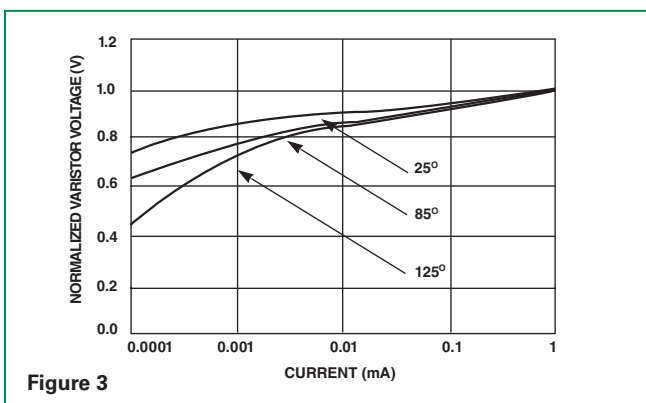


Figure 3

### Impedance (Z) vs Frequency Typical Characteristic

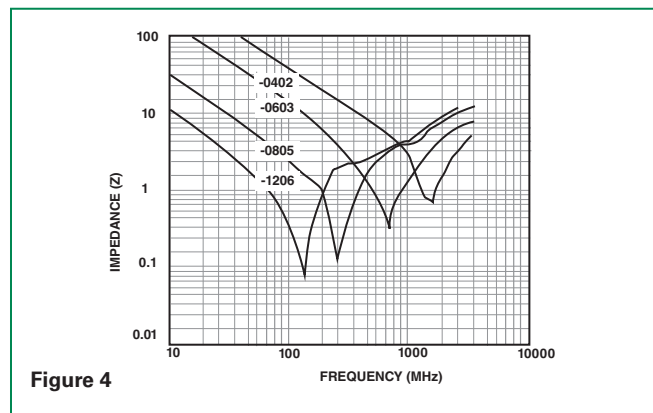


Figure 4

**Device Characteristics**

At low current levels, the V-I curve of the multilayer transient voltage suppressor approaches a linear (ohmic) relationship and shows a temperature dependent effect. At or below the maximum working voltage, the suppressor is in a high resistance model (approaching  $10^6\Omega$  at its maximum rated working voltage). Leakage currents at maximum rated voltage are below  $100\mu A$ , typically  $25\mu A$ ; for 0402 size below  $20\mu A$ , typically  $5\mu A$ .

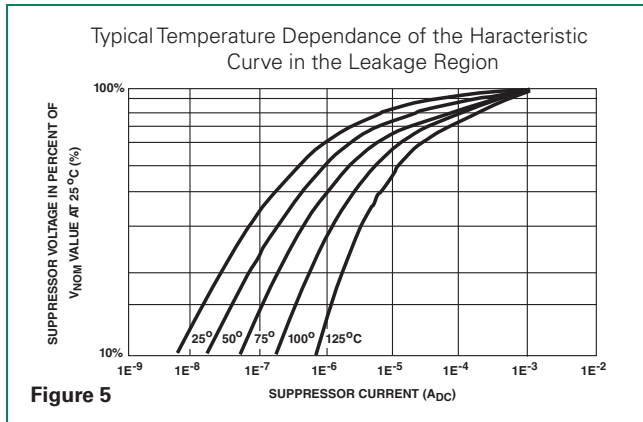


Figure 5

**Speed of Response**

The Multilayer Suppressor is a leadless device. Its response time is not limited by the parasitic lead inductances found in other surface mount packages. The response time of the  $Z_{N}O$  dielectric material is less than 1ns and the MLE can clamp very fast dV/dT events such as ESD. Additionally, in "real world" applications, the associated circuit wiring is often the greatest factor effecting speed of response. Therefore, transient suppressor placement within a circuit can be considered important in certain instances.

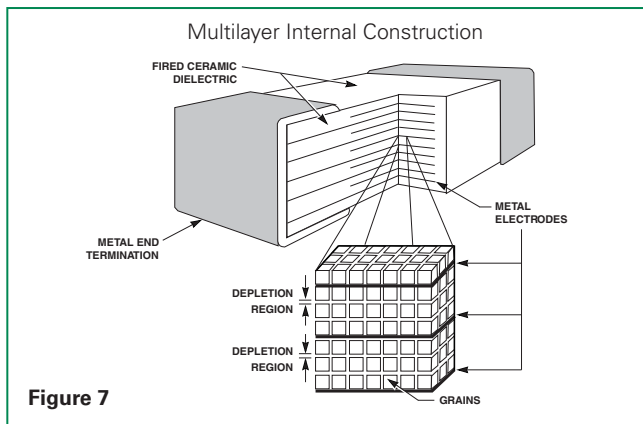


Figure 7

**Clamping Voltage Over Temperature ( $V_c$  at 10A)**

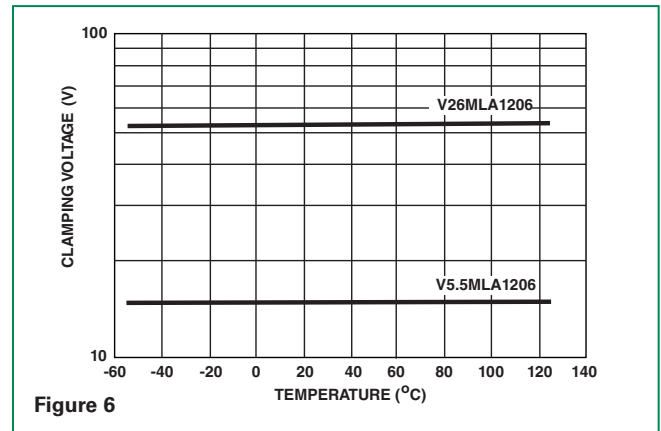


Figure 6

**Energy Absorption/Peak Current Capability**

Energy dissipated within the MLE is calculated by multiplying the clamping voltage, transient current and transient duration. An important advantage of the multilayer is its interdigitated electrode construction within the mass of dielectric material. This results in excellent current distribution and the peak temperature per energy absorbed is very low. The matrix of semiconducting grains combine to absorb and distribute transient energy (heat) (see Speed of Response). This dramatically reduces peak temperature; thermal stresses and enhances device reliability.

As a measure of the device capability in energy and peak current handling, the V26MLA1206A part was tested with multiple pulses at its peak current rating (150A, 8/20 $\mu$ s). At the end of the test, 10,000 pulses later, the device voltage characteristics are still well within specification.

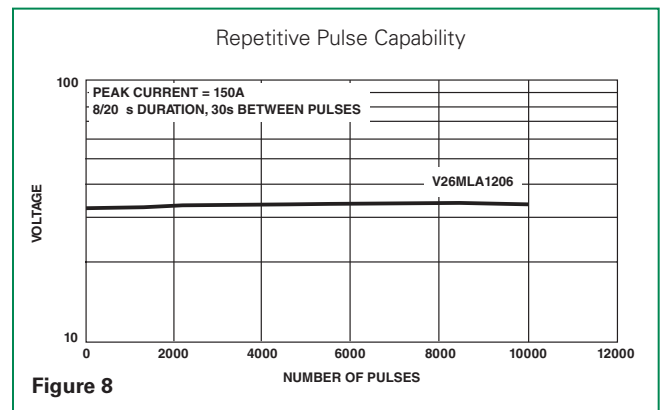


Figure 8

MLE Series

### Lead (Pb) Soldering Recommendations

The principal techniques used for the soldering of components in surface mount technology are IR Re-flow and Wave soldering. Typical profiles are shown on the right.

The recommended solder for the MLE suppressor is a 62/36/2 (Sn/Pb/Ag), 60/40 (Sn/Pb) or 63/37 (Sn/Pb). Littelfuse also recommends an RMA solder flux.

Wave soldering is the most strenuous of the processes. To avoid the possibility of generating stresses due to thermal shock, a preheat stage in the soldering process is recommended, and the peak temperature of the solder process should be rigidly controlled.

When using a reflow process, care should be taken to ensure that the MLE chip is not subjected to a thermal gradient steeper than 4 degrees per second; the ideal gradient being 2 degrees per second. During the soldering process, preheating to within 100 degrees of the solder's peak temperature is essential to minimize thermal shock.

Once the soldering process has been completed, it is still necessary to ensure that any further thermal shocks are avoided. One possible cause of thermal shock is hot printed circuit boards being removed from the solder process and subjected to cleaning solvents at room temperature. The boards must be allowed to cool gradually to less than 50°C before cleaning.

### Reflow Solder Profile

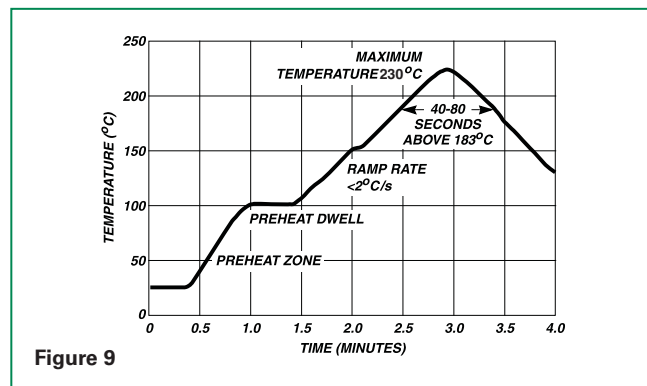


Figure 9

### Wave Solder Profile

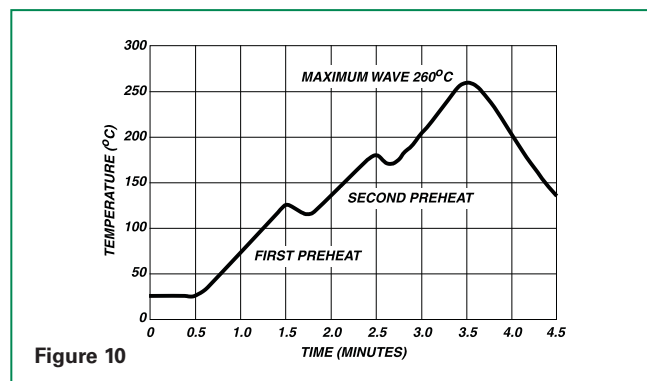


Figure 10

### Lead-free (Pb-free) Soldering Recommendations

Littelfuse offers the Nickel Barrier Termination finish for the optimum Lead-free solder performance.

The preferred solder is 96.5/3.0/0.5 (SnAgCu) with an RMA flux, but there is a wide selection of pastes and fluxes available with which the Nickel Barrier parts should be compatible.

The reflow profile must be constrained by the maximums in the Lead-free Reflow Profile. For Lead-free Wave soldering, the Wave Solder Profile still applies.

Note: the Lead-free paste, flux and profile were used for evaluation purposes by Littelfuse, based upon industry standards and practices. There are multiple choices of all three available, it is advised that the customer explores the optimum combination for their process as processes vary considerably from site to site.

### Lead-free Re-flow Profile

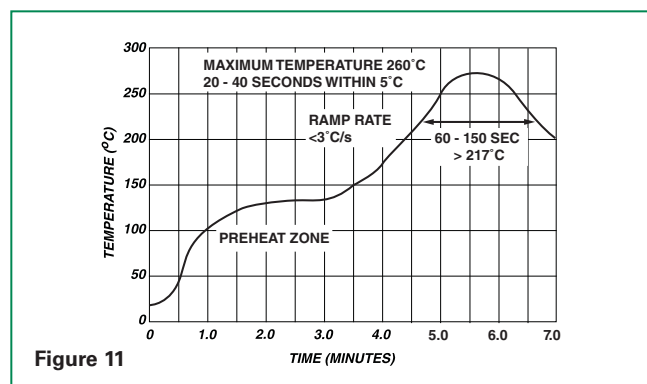
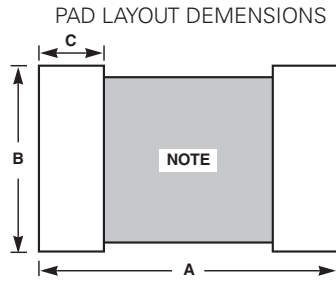
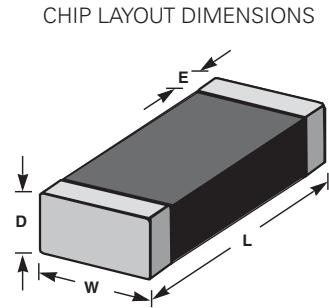


Figure 11

### Product Dimensions (mm)



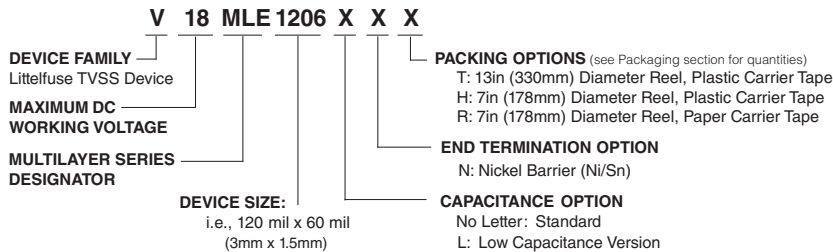
**NOTE:** Avoid metal runs in this area.  
 Note: Avoid metal runs in this area, parts are not recommended for use in applications using Silver (Ag) epoxy paste.



Dimension	1206 Size		0805 Size		0603 Size		0402 Size	
	IN	MM	IN	MM	IN	MM	IN	MM
<b>A</b>	0.160	4.06	0.120	3.05	0.100	2.54	0.067	1.70
<b>B</b>	0.065	1.65	0.050	1.27	0.030	0.76	0.020	0.51
<b>C</b>	0.040	1.02	0.040	1.02	0.035	0.89	0.024	0.61
<b>D (max.)</b>	0.071	1.80	0.043	1.10	0.040	1.00	0.024	0.60
<b>E</b>	0.02 +/- 0.01	0.50 +/- 0.25	0.02 +/- 0.01	0.50 +/- 0.25	0.015 +/- 0.008	0.4 +/- 0.2	0.010 +/- 0.006	0.25 +/- 0.15
<b>L</b>	0.125 +/- 0.012	3.20 +/- 0.03	0.079 +/- 0.008	2.01 +/- 0.2	0.063 +/- 0.006	1.6 +/- 0.15	0.039 +/- 0.004	1.0 +/- 0.1
<b>W</b>	0.06 +/- 0.011	1.60 +/- 0.28	0.049 +/- 0.008	1.25 +/- 0.2	0.032 +/- 0.006	0.8 +/- 0.15	0.020 +/- 0.004	0.5 +/- 0.1

**MLE Series**

### Part Numbering System

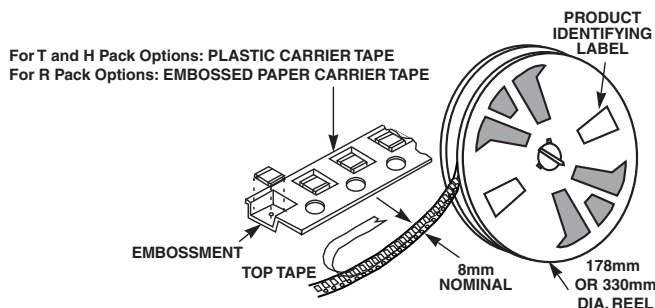
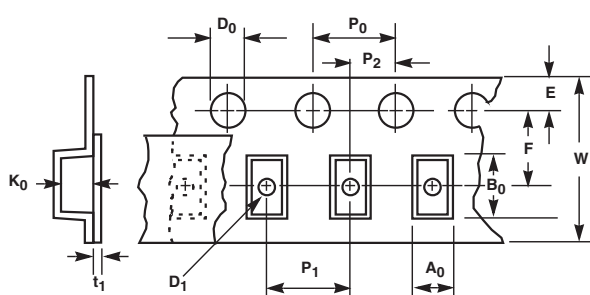


### Packaging\*

Device Size	Quantity			
	13" Inch Reel ('T' Option)	7" Inch Reel ('H' Option)	7" Inch Reel ('R' Option)	Bulk Pack ('A' Option)
1206	10,000	2,500	N/A	2500
0805	10,000	2,500	N/A	2500
0603	10,000	2,500	4,000	2500
0402	N/A	N/A	10,000	N/A

\*(Packaging) It is recommended that parts be kept in the sealed bag provided and that parts be used as soon as possible when removed from bags.

### Tape and Reel Specifications



Symbol	Description	Dimensions in Millimeters	
		0402 Size	0603, 0805 & 1206 Sizes
$A_0$	Width of Cavity	Dependent on Chip Size to Minimize Rotation.	
$B_0$	Length of Cavity	Dependent on Chip Size to Minimize Rotation.	
$K_0$	Depth of Cavity	Dependent on Chip Size to Minimize Rotation.	
$W$	Width of Tape	8 +/- 0.2	8 +/- 0.3
$F$	Distance Between Drive Hole Centers and Cavity Centers	3.5 +/- 0.05	3.5 +/- 0.05
$E$	Distance Between Drive Hole Centers and Tape Edge	1.75 +/- 0.1	1.75 +/- 0.1
$P_1$	Distance Between Cavity Centers	2 +/- 0.05	4 +/- 0.1
$P_2$	Axial Drive Distance Between Drive Hole Centers & Cavity Centers	2 +/- 0.1	2 +/- 0.1
$P_0$	Axial Drive Distance Between Drive Hole Centers	4 +/- 0.1	4 +/- 0.1
$D_0$	Drive Hole Diameter	1.55 +/- 0.05	1.55 +/- 0.05
$D_1$	Diameter of Cavity Piercing	N/A	1.05 +/- 0.05
$T_1$	Top Tape Thickness	0.1 Max	0.1 Max

- Notes :
- Conforms to EIA-481-1, Revision A
  - Can be supplied to IEC publication 286-3

### RoHS ML Varistor Series



#### Size Table

Metric	EIA
1005	0402
1608	0603
2012	0805
3216	1206
3225	1210

#### Applications

- Suppression of inductive switching or other transient events such as EFT and surge voltage at the circuit board level
- ESD protection for IEC 61000-4-2, MIL-STD-883c method 3015.7, and other industry specifications (see also the MLE or MLN Series)
- Provides on-board transient voltage protection for ICS and transistors
- Used to help achieve electromagnetic compliance of end products
- Replace larger surface mount TVS Zeners in many applications

#### Description

The ML Series family of transient voltage surge suppression devices is based on the Littelfuse Multilayer fabrication technology. These components are designed to suppress a variety of transient events, including those specified in IEC 61000-4-2 or other standards used for Electromagnetic Compliance (EMC). The ML Series is typically applied to protect integrated circuits and other components at the circuit board level.

The wide operating voltage and energy range make the ML Series suitable for numerous applications on power supply, control and signal lines.

The ML Series is manufactured from semiconducting ceramics, and is supplied in a leadless, surface mount package. The ML Series is compatible with modern reflow and wave soldering procedures.

It can operate over a wider temperature range than Zener diodes, and has a much smaller footprint than plastic-housed components.

Littelfuse Inc. manufactures other multilayer series products. See the MLE Series data sheet for ESD applications, MHS Series data sheet for high-speed ESD applications, the MLN Series for multilayer protection and the AUML Series for automotive applications.

#### Features

- AEC - Q200 compliant
- RoHS compliant
- Leadless 0402, 0603, 0805, 1206 and 1210 chip sizes
- Multilayer ceramic construction technology
- -55°C to +125°C operating temp. range
- Operating voltage range  $V_{M(DC)} = 5.5V$  to 120V
- Rated for surge current ( $8 \times 20\mu s$ )
- Rated for energy ( $10 \times 1000\mu s$ )
- Inherent bi-directional clamping
- No plastic or epoxy packaging assures better than UL94V-0 flammability rating
- Standard low capacitance types available

#### Absolute Maximum Ratings

For ratings of individual members of a series, see device ratings and specifications table.

Continuous	ML Series	Units
<b>Steady State Applied Voltage:</b>		
DC Voltage Range ( $V_{M(DC)}$ )	3.5 to 120	V
AC Voltage Range ( $V_{M(ACRMS)}$ )	2.5 to 107	V
<b>Transient:</b>		
Non-Repetitive Surge Current, 8/20 $\mu s$ Waveform, ( $I_{TM}$ )	4 to 500	A
Non-Repetitive Surge Energy, 10/1000 $\mu s$ Waveform, ( $W_{TM}$ )	0.02 to 2.5	J
Operating Ambient Temperature Range ( $T_A$ )	-55 to +125	°C
Storage Temperature Range ( $T_{STG}$ )	-55 to +150	°C
Temperature Coefficient ( $\alpha V$ ) of Clamping Voltage ( $V_C$ ) at Specified Test Current	<0.01	%/°C



### Device Ratings and Specifications

Part Number	Maximum Ratings (125° C)					Specifications (25°C)		
	Maximum Continuous Working Voltage		Maximum Non-repetitive Surge Current (8/20 $\mu$ s)	Maximum Non-repetitive Surge Energy (10/1000 $\mu$ s)	Maximum Clamping Voltage at 1A (or as Noted) (8/20 $\mu$ s)	Nominal Voltage at 1mA DC Test Current		Typical Capacitance at f = 1MHz
	V <sub>M(DC)</sub>	V <sub>M(AC)</sub>	I <sub>TM</sub>	W <sub>TM</sub>	V <sub>C</sub>	V <sub>N(DC) Min</sub>	V <sub>N(DC) Max</sub>	C
	(V)	(V)	(A)	(J)	(V)	(V)	(V)	(pF)
V3.5MLA0603N <sup>5</sup>	3.5	2.5	30	0.100	13.0	3.7	7.0	1270
V3.5MLA0805N	3.5	2.5	120	0.300	13.0	3.7	7.0	2530
V3.5MLA0805LN	3.5	2.5	40	0.100	13.0	3.7	7.0	1380
V3.5MLA1206N	3.5	2.5	100	0.300	13.0	3.7	7.0	6000
V5.5MLA0402N	5.5	4.0	20	0.050	21.0	7.1	10.8	220
V5.5MLA0402LN	5.5	4.0	20	0.050	39.0	15.9	21.5	70
V5.5MLA0603N <sup>5</sup>	5.5	4.0	30	0.100	17.5	7.1	9.3	760
V5.5MLA0603LN <sup>4</sup>	5.5	4.0	30	0.100	17.5	7.1	9.3	450
V5.5MLA0805N	5.5	4.0	120	0.300	17.5	7.1	9.3	1840
V5.5MLA0805LN	5.5	4.0	40	0.100	17.5	7.1	9.3	990
V5.5MLA1206N	5.5	4.0	150	0.400	17.5	7.1	9.3	3500
V9MLA0402N	9.0	6.5	20	0.050	30.0	11.0	16.0	120
V9MLA0402LN	9.0	6.5	4	0.020	35.0	11.0	16.0	33
V9MLA0603N <sup>5</sup>	9.0	6.5	30	0.100	25.5	11.0	16.0	490
V9MLA0603LN <sup>4</sup>	9.0	6.5	30	0.100	25.5	11.0	16.0	360
V9MLA0805LN	9.0	6.5	40	0.100	25.5	11.0	16.0	520
V12MLA0805LN	12.0	9.0	40	0.100	29.0	14.0	18.5	410
V14MLA0402N	14.0	10.0	20	0.050	39.0	15.9	21.5	70
V14MLA0603N	14.0	10.0	30	0.100	34.5	15.9	21.5	180
V14MLA0805N	14.0	10.0	120	0.300	32.0	15.9	20.3	560
V14MLA0805LN	14.0	10.0	40	0.100	32.0	15.9	20.3	320
V14MLA1206N	14.0	10.0	150	0.400	32.0	15.9	20.3	1400
V18MLA0402N	18.0	14.0	20	0.050	50.0	22.0	28.0	40
V18MLA0603N	18.0	14.0	30	0.100	50.0	22.0	28.0	120
V18MLA0805N	18.0	14.0	120	0.300	44.0	22.0	28.0	520
V18MLA0805LN	18.0	14.0	40	0.100	44.0	22.0	28.0	290
V18MLA1206N	18.0	14.0	150	0.400	44.0	22.0	28.0	1270
V18MLA1210N	18.0	14.0	500	2.500	44.0 at 2.5	22.0	28.0	1440
V26MLA0603N	26.0	20.0	30	0.100	60.0	31.0	38.0	110
V26MLA0805N	26.0	20.0	100	0.300	60.0	29.5	38.5	220
V26MLA0805LN	26.0	20.0	40	0.100	60.0	29.5	38.5	140
V26MLA1206N	26.0	20.0	150	0.600	60.0	29.5	38.5	600
V26MLA1210N	26.0	20.0	300	1.200	60.0 at 2.5	29.5	38.5	1040
V30MLA0603N	30.0	25.0	30	0.100	74.0	37.0	46.0	90
V30MLA0805LN	30.0	25.0	30	0.100	72.0	37.0	46.0	90
V30MLA1210N	30.0	25.0	280	1.200	68.0 at 2.5	35.0	43.0	1820
V30MLA1210LN	30.0	25.0	220	0.900	68.0 at 2.5	35.0	43.0	1760
V33MLA1206N	33.0	26.0	180	0.800	75.0	38.0	49.0	500
V42MLA1206N	42.0	30.0	180	0.800	92.0	46.0	60.0	425
V48MLA1210N	48.0	40.0	250	1.200	105.0 at 2.5	54.5	66.5	520
V48MLA1210LN	48.0	40.0	220	0.900	105.0 at 2.5	54.5	66.5	500
V56MLA1206N	56.0	40.0	180	1.000	120.0	61.0	77.0	180
V60MLA1210N	60.0	50.0	250	1.500	130.0 at 2.5	67.0	83.0	440
V68MLA1206N	68.0	50.0	180	1.000	140.0	76.0	90.0	100
V85MLA1210N	85.0	67.0	250	2.500	180.0 at 2.5	95.0	115.0	260
V120MLA1210N	120.0	107.0	125	2.000	260.0 at 2.5	135.0	165.0	80

**NOTES:**

- 1 'L' suffix is a low capacitance and energy version; Contact your Littelfuse sales representative for custom capacitance requirements
- 2 Typical leakage at 25°C < 25 $\mu$ A, maximum leakage 100 $\mu$ A at V<sub>M(DC)</sub>; for 0402 size, typical leakage < 5 $\mu$ A, maximum leakage < 20 $\mu$ A at V<sub>M(DC)</sub>
- 3 Average power dissipation of transients for 0402, 0603, 0805, 1206 and 1210 sizes not to exceed 0.03W, 0.05W, 0.1W, 0.1W and 0.15W respectively
- 4 Only available in 'R' packing option
- 5 Only available in 'H', 'T' and 'A' packing options

**Peak Current and Energy Derating Curve**

When transients occur in rapid succession, the average power dissipation is the energy (watt-seconds) per pulse times the number of pulses per second. The power so developed must be within the specifications shown on the Device Ratings and Specifications Table for the specific device. For applications exceeding 125°C ambient temperature, the peak surge current and energy ratings must be derated as shown below.

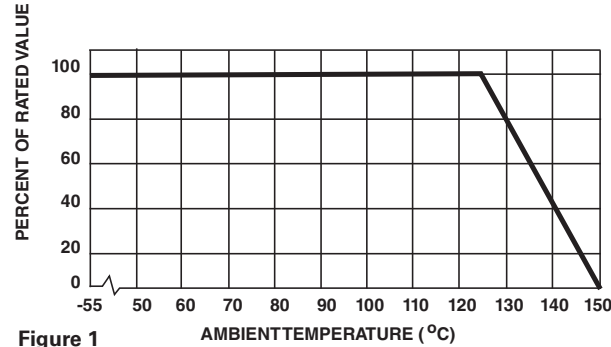


Figure 1

**Peak Pulse Current Test Waveform for Clamping Voltage**

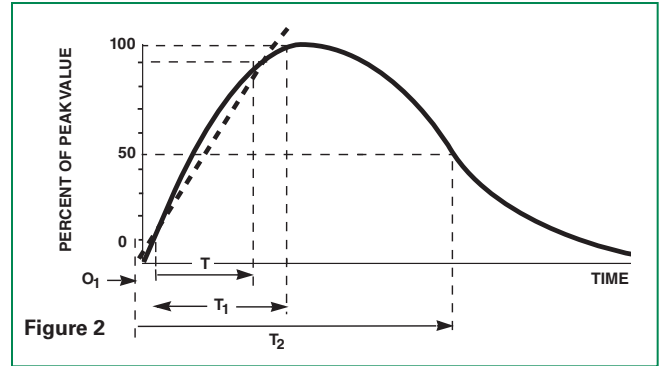


Figure 2

$O_1$  = Virtual Origin of Wave  
 $T$  = Time from 10% to 90% of Peak  
 $T_1$  = Rise Time =  $1.25 \times T$   
 $T_2$  = Decay Time

**Example** - For an  $8/20 \mu s$  Current Waveform:

$8 \mu s = T_1 = \text{Rise Time}$   
 $20 \mu s = T_2 = \text{Decay Time}$

**Limit V-I Characteristic for V5.5MLA0402 to V18MLA0402**

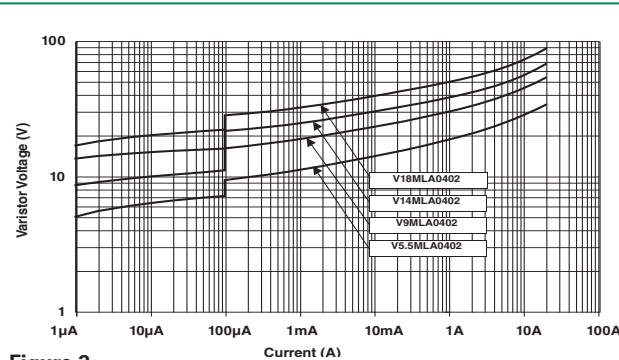


Figure 3

**Limit V-I Characteristic for V9MLA0402L**

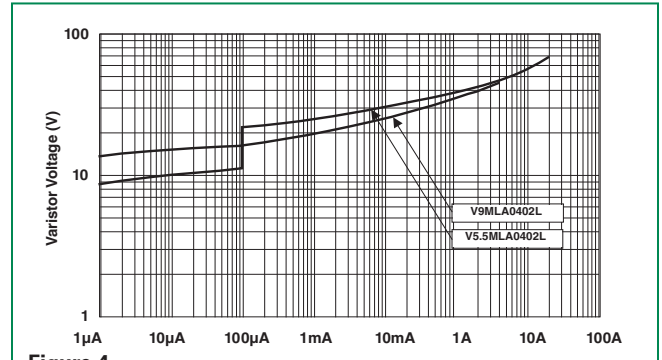


Figure 4

**Limit V-I Characteristic for V3.5MLA0603 to V30MLA0603**

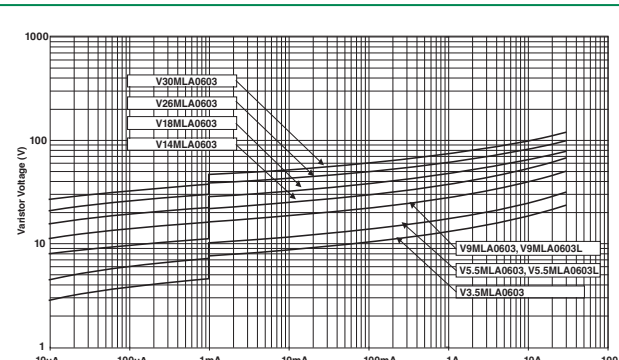


Figure 5

**Limit V-I Characteristic for V3.5MLA0805L to V30MLA0805L**

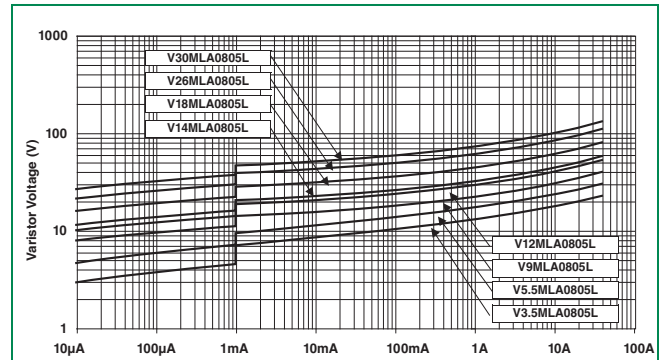
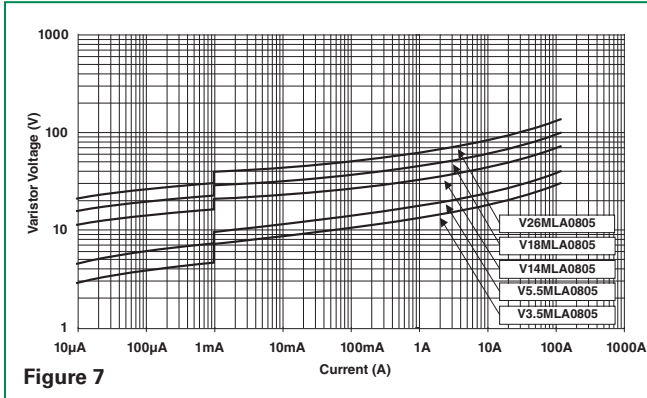
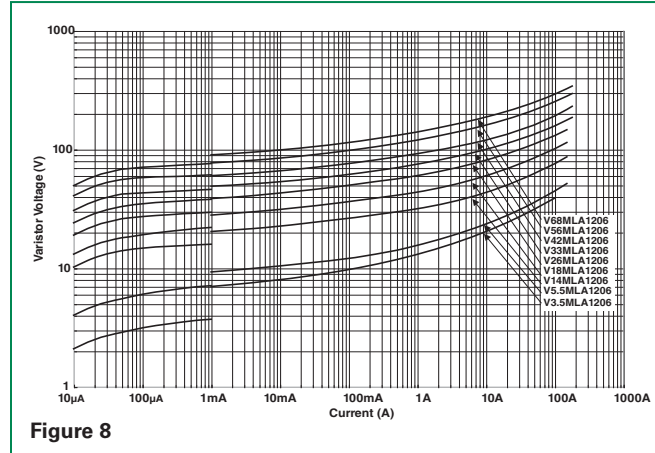


Figure 6

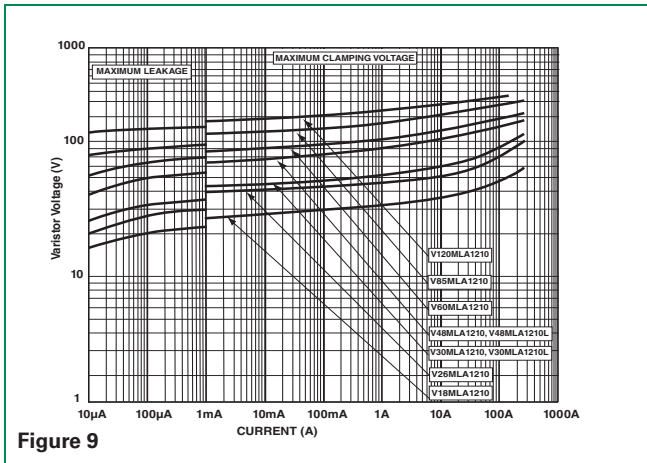
### Limit V-I Characteristic for V3.5MLA0805 to V26MLA0805



### Limit V-I Characteristic for V3.5MLA1206 to V68MLA1206

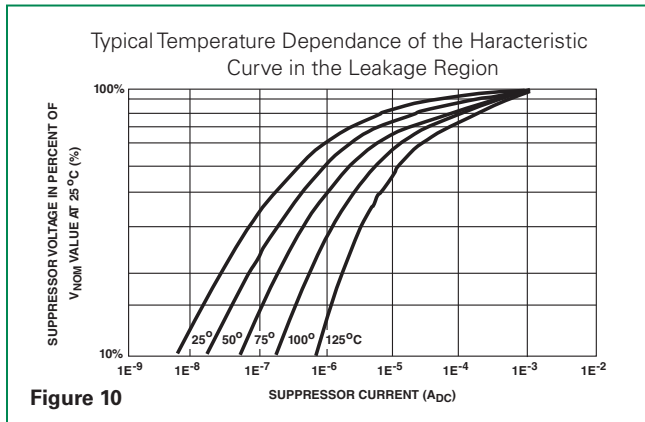


### Limit V-I Characteristic for V18MLA1210 to V120MLA1210



**Device Characteristics**

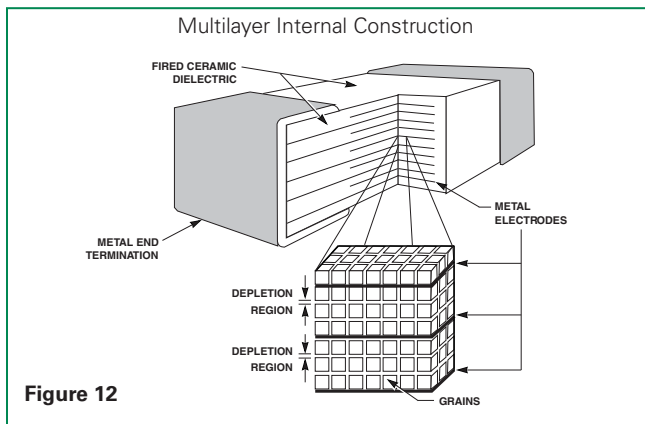
At low current levels, the V-I curve of the multilayer transient voltage suppressor approaches a linear (ohmic) relationship and shows a temperature dependent effect. At or below the maximum working voltage, the suppressor is in a high resistance modex (approaching  $10^6\Omega$  at its maximum rated working voltage). Leakage currents at maximum rated voltage are below  $100\mu A$ , typically  $25\mu A$ ; for 0402 size below  $20\mu A$ , typically  $5\mu A$ .



**Figure 10**

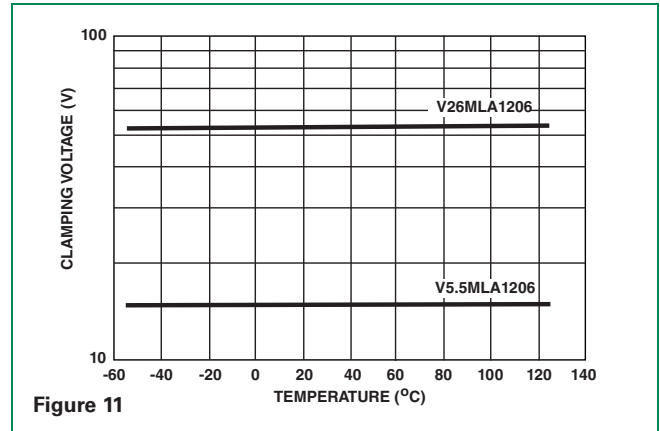
**Speed of Response**

The Multilayer Suppressor is a leadless device. Its response time is not limited by the parasitic lead inductances found in other surface mount packages. The response time of the  $Z_{N}O$  dielectric material is less than 1ns and the ML can clamp very fast dV/dT events such as ESD. Additionally, in "real world" applications, the associated circuit wiring is often the greatest factor effecting speed of response. Therefore, transient suppressor placement within a circuit can be considered important in certain instances.



**Figure 12**

**Clamping Voltage Over Temperature ( $V_c$  at 10A)**

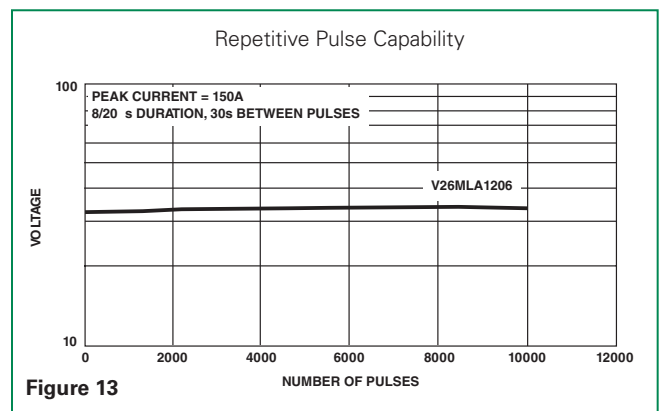


**Figure 11**

**Energy Absorption/Peak Current Capability**

Energy dissipated within the ML Series is calculated by multiplying the clamping voltage, transient current and transient duration. An important advantage of the multilayer is its interdigitated electrode construction within the mass of dielectric material. This results in excellent current distribution and the peak temperature per energy absorbed is very low. The matrix of semiconducting grains combine to absorb and distribute transient energy (heat) (see Speed of Response). This dramatically reduces peak temperature; thermal stresses and enhances device reliability.

As a measure of the device capability in energy and peak current handling, the V26MLA1206A part was tested with multiple pulses at its peak current rating ( $150A$ ,  $8/20\mu s$ ). At the end of the test, 10,000 pulses later, the device voltage characteristics are still well within specification.



**Figure 13**

ML Series

### Lead (Pb) Soldering Recommendations

The principal techniques used for the soldering of components in surface mount technology are IR Re-flow and Wave soldering. Typical profiles are shown on the right.

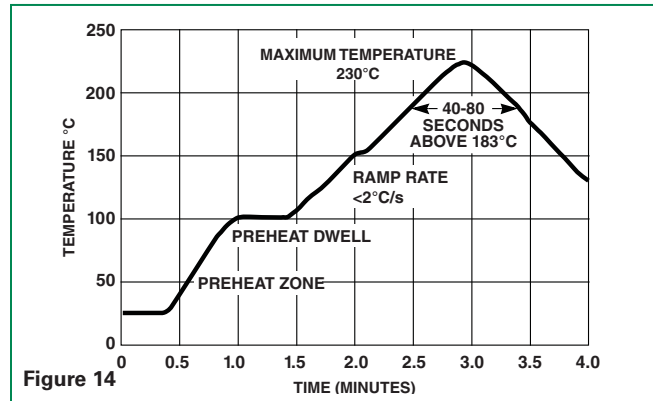
The recommended solder for the ML suppressor is a 62/36/2 (Sn/Pb/Ag), 60/40 (Sn/Pb) or 63/37 (Sn/Pb). Littelfuse also recommends an RMA solder flux.

Wave soldering is the most strenuous of the processes. To avoid the possibility of generating stresses due to thermal shock, a preheat stage in the soldering process is recommended, and the peak temperature of the solder process should be rigidly controlled.

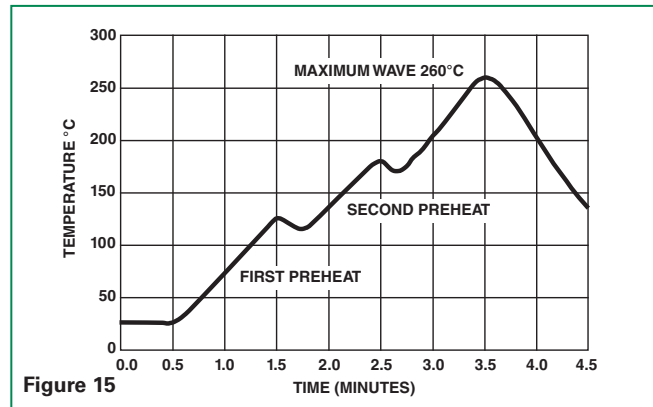
When using a reflow process, care should be taken to ensure that the ML chip is not subjected to a thermal gradient steeper than 4 degrees per second; the ideal gradient being 2 degrees per second. During the soldering process, preheating to within 100 degrees of the solder's peak temperature is essential to minimize thermal shock.

Once the soldering process has been completed, it is still necessary to ensure that any further thermal shocks are avoided. One possible cause of thermal shock is hot printed circuit boards being removed from the solder process and subjected to cleaning solvents at room temperature. The boards must be allowed to cool gradually to less than 50° C before cleaning.

### Reflow Solder Profile



### Wave Solder Profile



### Lead-free (Pb-free) Soldering Recommendations

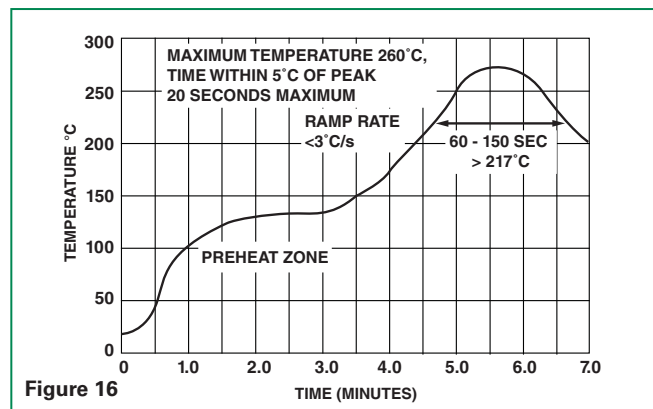
Littelfuse offers the Nickel Barrier Termination option (see "N" suffix in Part Numbering System for ordering) for the optimum Lead-free solder performance, consisting of a Matte Tin outer surface plated on Nickel underlayer, plated on Silver base metal.

The preferred solder is 96.5/3.0/0.5 (SnAgCu) with an RMA flux, but there is a wide selection of pastes and fluxes available with which the Nickel Barrier parts should be compatible.

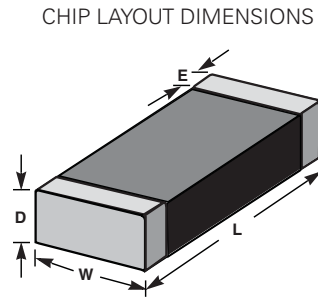
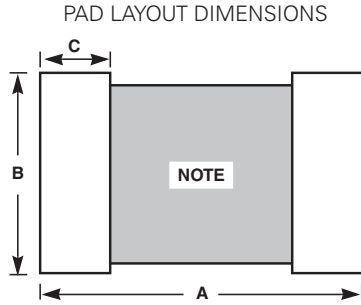
The reflow profile must be constrained by the maximums in the Lead-free Reflow Profile. For Lead-free wave soldering, the Wave Solder Profile still applies.

Note: the Lead-free paste, flux and profile were used for evaluation purposes by Littelfuse, based upon industry standards and practices. There are multiple choices of all three available, it is advised that the customer explores the optimum combination for their process as processes vary considerably from site to site.

### Lead-free Re-flow Solder Profile



### Product Dimensions (mm)

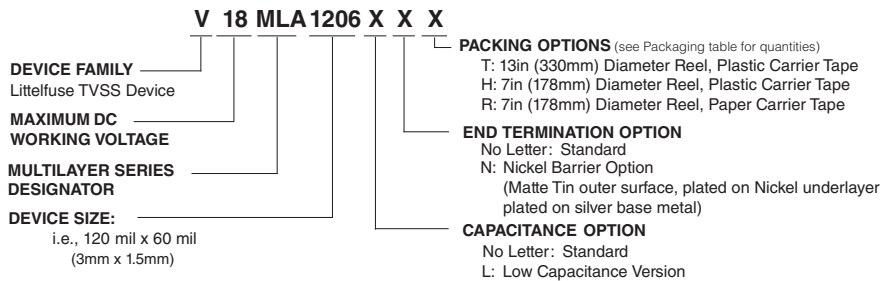


NOTE : Avoid metal runs in this area, parts not recommended for use in applications using Silver (Ag) epoxy paste.

Dimension	1210 Size		1206 Size		0805 Size		0603 Size		0402 Size	
	IN	MM	IN	MM	IN	MM	IN	MM	IN	MM
<b>A</b>	0.160	4.06	0.160	4.06	0.120	3.05	0.100	2.54	0.067	1.70
<b>B</b>	0.100	2.54	0.065	1.65	0.050	1.27	0.030	0.76	0.020	0.51
<b>C</b>	0.040	1.02	0.040	1.02	0.040	1.02	0.035	0.89	0.024	0.61
<b>D (max.)</b>	0.113	2.87	0.071	1.80	0.043	1.10	0.040	1.00	0.024	0.60
<b>E</b>	0.020 -/+0.010	0.50 -/+0.25	0.020 -/+0.010	0.50 -/+0.25	0.020 +/- 0.010	0.50 +/- 0.25	0.015 -/+0.008	0.4 -/+0.20	0.010 -/+0.006	0.25 -/+0.15
<b>L</b>	0.125 -/+0.012	3.20 -/+0.30	0.125 -/+0.012	3.20 -/+0.30	0.079 -/+0.008	2.01 -/+0.20	0.063 -/+0.006	1.6 -/+0.15	0.039 -/+0.004	1.00 -/+0.10
<b>W</b>	0.100 -/+0.012	2.54 -/+0.30	0.060 -/+0.011	1.60 -/+0.28	0.049 -/+0.008	1.25 -/+0.20	0.032 -/+0.060	0.8 -/+0.15	0.020 -/+0.004	0.50 -/+0.10

ML Series

### Part Numbering System



**\*NOTES:**

1 V120MLA1210 standard shipping quantities are 1000 pieces per reel for the "H" option and 4000 pieces per reel for "T" option.  
 2 V3.5 MLA0603, V5.5MLA0603 and V9MLA0603 only available in "H," "T" and "A" packing options.

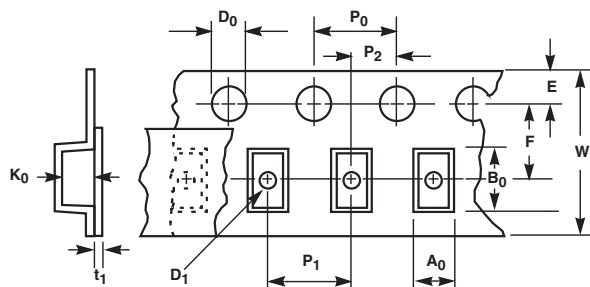
### Packaging\*

Device Size	Quantity			
	13" Inch Reel ("T" Option)	7" Inch Reel ("H" Option)	7" Inch Reel ("R" Option)	Bulk Pack ("A" Option)
1210	8,000	2,000	N/A	2,000
1206	10,000	2,500	N/A	2,500
0805	10,000	2,500	N/A	2,500
0603	10,000	2,500	4,000	2,500
0402	N/A	N/A	10,000	N/A

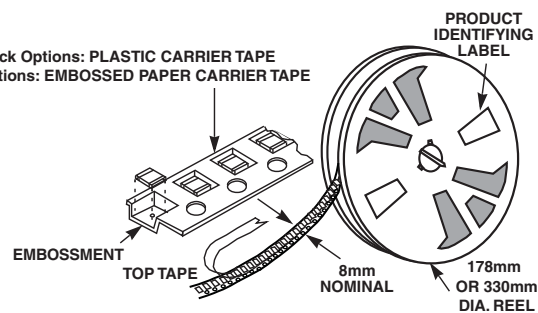
\*(Packaging) It is recommended that parts be kept in the sealed bag provided and that parts be used as soon as possible when removed from bags.



### Tape and Reel Specifications



For T and H Pack Options: PLASTIC CARRIER TAPE  
 For R Pack Options: EMBOSSED PAPER CARRIER TAPE

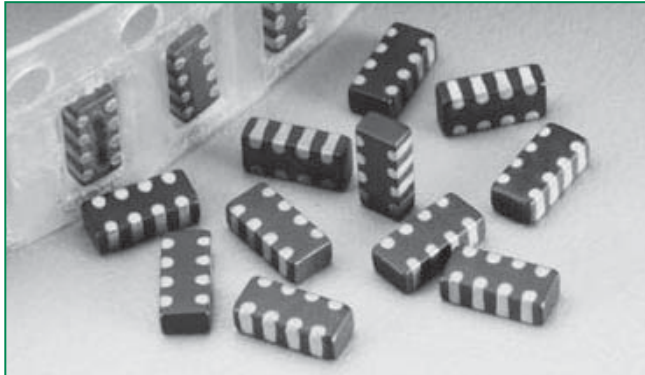


Symbol	Description	Dimensions in Millimeters	
		0402 Size	0603, 0805, 1206 & 1210 Sizes
$A_0$	Width of Cavity	Dependent on Chip Size to Minimize Rotation.	
$B_0$	Length of Cavity	Dependent on Chip Size to Minimize Rotation.	
$K_0$	Depth of Cavity	Dependent on Chip Size to Minimize Rotation.	
$W$	Width of Tape	8 $\pm$ 0.2	8 $\pm$ 0.3
$F$	Distance Between Drive Hole Centers and Cavity Centers	3.5 $\pm$ 0.05	3.5 $\pm$ 0.05
$E$	Distance Between Drive Hole Centers and Tape Edge	1.75 $\pm$ 0.1	1.75 $\pm$ 0.1
$P_1$	Distance Between Cavity Centers	2 $\pm$ 0.05	4 $\pm$ 0.1
$P_2$	Axial Drive Distance Between Drive Hole Centers & Cavity Centers	2 $\pm$ 0.1	2 $\pm$ 0.1
$P_0$	Axial Drive Distance Between Drive Hole Centers	4 $\pm$ 0.1	4 $\pm$ 0.1
$D_0$	Drive Hole Diameter	1.55 $\pm$ 0.05	1.55 $\pm$ 0.05
$D_1$	Diameter of Cavity Piercing	N/A	1.05 $\pm$ 0.05
$T_1$	Top Tape Thickness	0.1 Max	0.1 Max

NOTES:

- Conforms to EIA-481-1, Revision A
- Can be supplied to IEC publication 286-3

### RoHS MLN SurgeArray™ Suppressor



#### Size Table

Metric	EIA
3216	1206

#### Applications

- Data, Diagnostic I/O Ports
- Analog Signal/Sensor Lines
- Portable/Hand-Held Products
- Mobile
- Communications/Cellular Phones
- Computer/DSP Products
- Industrial Instruments Including Medical

#### Description

The MLN SurgeArray™ Suppressor is designed to help protect components from transient voltages that exist at the circuit board level. This device provides four independent suppressors in a single leadless chip in order to reduce part count and placement time as well as save space on printed circuit boards.

SurgeArray™ devices are intended to suppress ESD, EFT and other transients in order to protect integrated circuits or other sensitive components operating at any voltage up to 18V<sub>DC</sub>. SurgeArray™ devices are rated to the IEC 61000-4-2 human body model ESD to help products attain EMC compliance. The array offers excellent isolation and low crosstalk between sections.

The inherent capacitance of the SurgeArray™ Suppressor permits it to function as a filter/suppressor, thereby replacing separate Zener/capacitor combinations.

The MLN array is manufactured using the Littelfuse Multilayer technology process and is similar to the Littelfuse ML and MLE Series of discrete leadless chips.

#### Features

- RoHS Compliant
- Four individual devices in one chip
- ESD rated to IEC 61000-4-2 (Level 4)
- AC characterized for impedance and capacitance
- Low adjacent channel crosstalk, -55dB at 10MHz (Typ)
- Low leakage
- Operating voltage up to 18V<sub>(MDC)</sub>
- -55°C to 125°C operating temp range
- Low-profile, PCMCIA compatible

#### Absolute Maximum Ratings

• For ratings of individual members of a series, see device ratings and specifications table.

Continuous	MLN Series	Units
Steady State Applied Voltage:		
DC Voltage Range (V <sub>MDC</sub> )	5.5 - 18	V
Operating Ambient Temperature Range (T <sub>A</sub> )	-55 to +125	°C
Storage Temperature Range (T <sub>STG</sub> )	-55 to +150	°C

### Device Ratings and Specifications Any Single Section

Part Number	Maximum Ratings (125°C)			Specifications (25°C)							
	Maximum Continuous Working Voltage	Maximum Non-repetitive Surge Current (8/20 $\mu$ s)	Maximum Non-repetitive Surge Energy (10/1000 $\mu$ s)	Maximum Clamping Voltage (at Noted 8/20 $\mu$ s Current)	Typical ESD Suppression Voltage (Note1)			Nominal Voltage at 1mA DC Test Current		Capacitance at 1 MHz (1V p-p)	
	$V_{M(DC)}$	$I_{TM}$	$W_{TM}$	$V_C$	(Note 2) 8kV Contact		(Note 3) 15kV Air	$V_{N(DC)}$ Min	$V_{N(DC)}$ Max	(Note 4) C	
	(V)	(A)	(J)	(V)	Peak	Clamp	Peak	(V)	(V)	TYP	MAX
	(V)	(A)	(J)	(V)	(V)	(V)	(V)	(V)	(V)	(pF)	(pF)
V5.5MLN41206	5.5	30	0.10	15.5 at 2A	60	35	45	7.10	10.8	430	520
V9MLN41206	9.0	30	0.10	23.0 at 2A	95	50	75	11.0	16.0	250	300
V14MLN41206	14.0	30	0.10	30.0 at 2A	110	55	85	15.9	20.3	140	175
V18MLN41206	18.0	30	0.10	40.0 at 2A	165	63	100	22.0	28.0	100	125
V18MLN41206L	18.0	30	0.05	50.0 at 1A	200	95	130	25.0	35.0	45	75

**NOTES:**

- Tested to IEC61000-4-2 Human Body Model (HBM) discharge test circuit.
- Direct discharge to device terminals (IEC preferred test method).
- Corona discharge through air (represents actual ESD event)
- Capacitance may be customized, contact Sales.

### Peak Current and Energy Derating Curve

For applications exceeding 125°C ambient temperature, the peak surge current and energy ratings must be reduced.

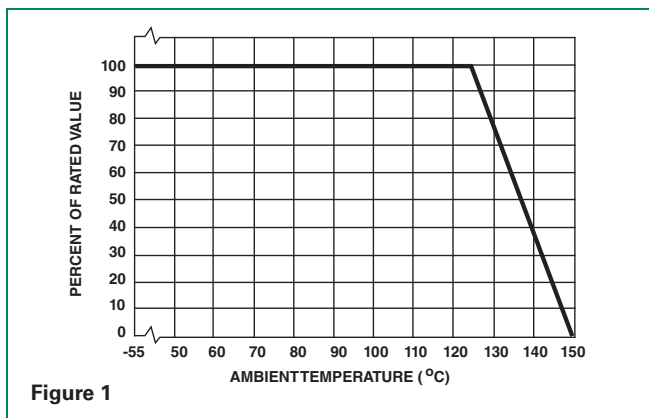


Figure 1

### Peak Pulse Current Test Waveform for Clamping Voltage

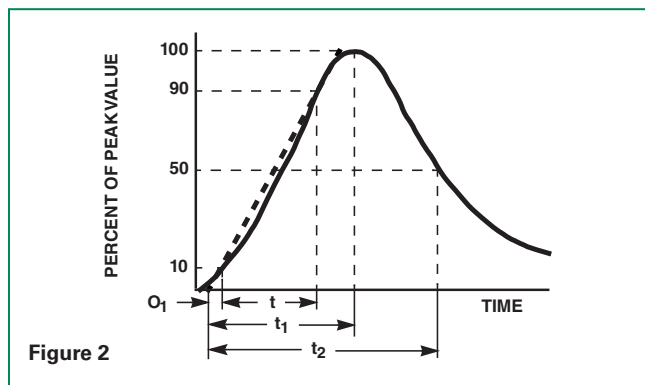


Figure 2

$O_1$  = Virtual Origin of Wave  
 $T$  = Time from 10% to 90% of Peak  
 $T_1$  = Rise Time =  $1.25 \times T$   
 $T_2$  = Decay Time (Impulse Duration)

**Example:**  
 For an 8/20  $\mu$ s Current Waveform:  
 $8\mu s = T_1 =$  Rise Time  
 $20\mu s = T_2 =$  Virtual Time to Half Value

### Typical Performance Curves

#### Equivalent Series Resistance

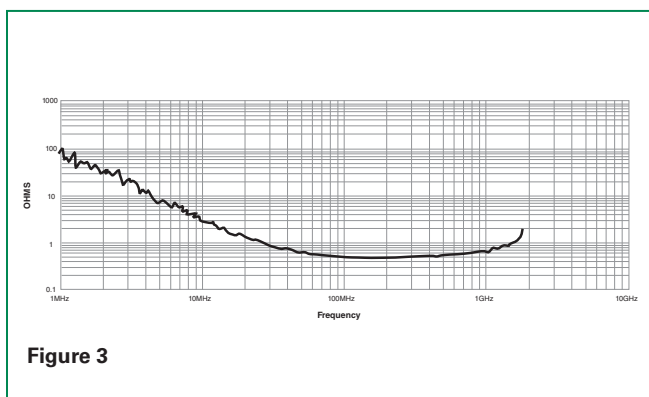


Figure 3

#### Impedance vs Frequency, 1206 Size

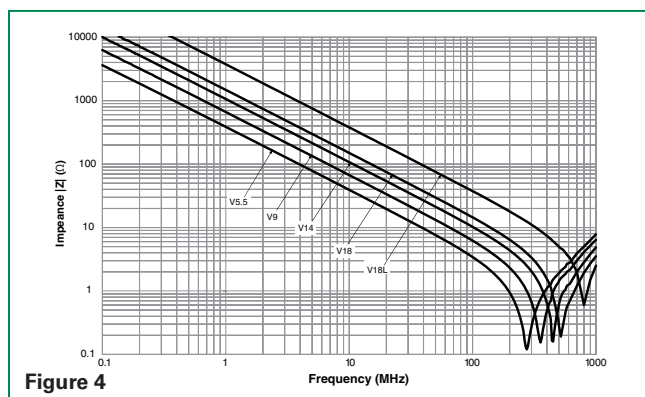


Figure 4

**Typical Performance Curves (continued)**

**Nominal Voltage Stability to IEC 1000-4-2 (8kV Contact Method, One Section)**

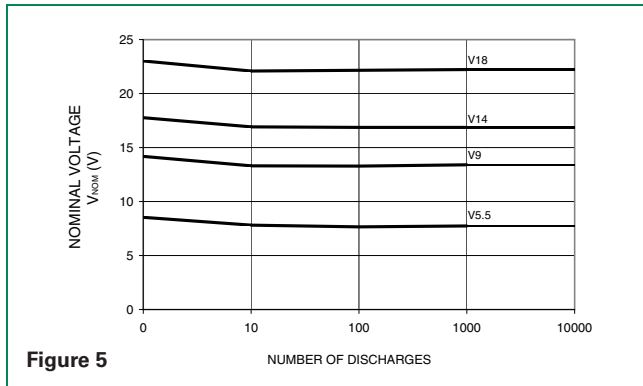


Figure 5

**1206 Size Pulse Rating for Long Duration Surges (Any Single Section)**

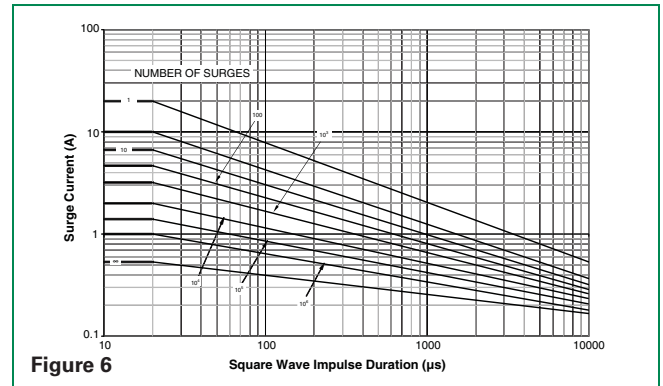


Figure 6

**V-I Characteristic, 1206 size**

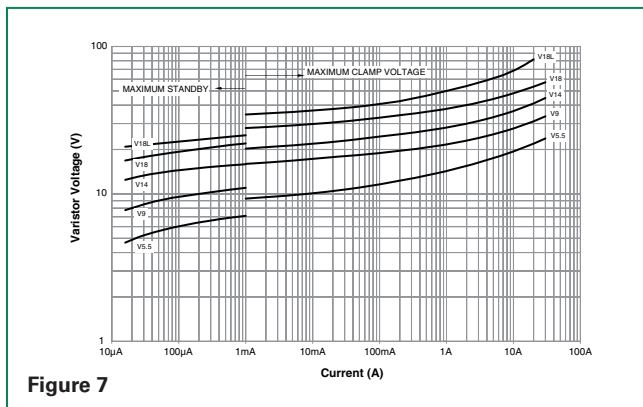


Figure 7

**Capacitance vs Frequency, 1206 Size**

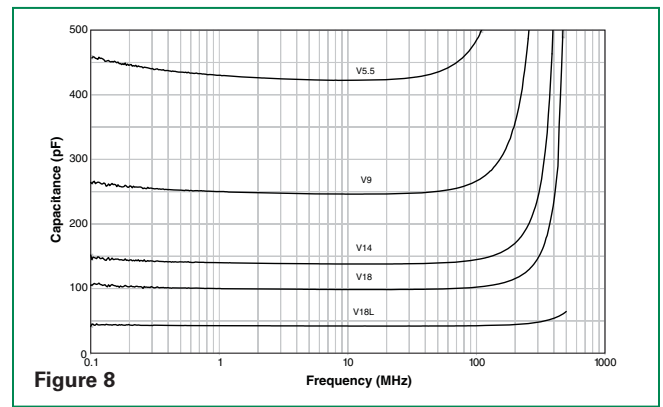


Figure 8

**Adjacent Channel Crosstalk**

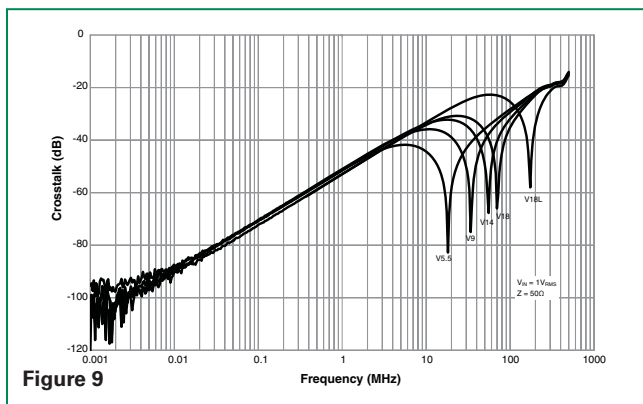


Figure 9

### Lead (Pb) Soldering Recommendations

The principal techniques used for the soldering of components in surface mount technology are IR Re-flow and Wave soldering. Typical profiles are shown on the right.

The recommended solder for the MLN suppressor is a 62/36/2 (Sn/Pb/Ag), 60/40 (Sn/Pb) or 63/37 (Sn/Pb). Littelfuse also recommends an RMA solder flux.

Wave soldering is the most strenuous of the processes. To avoid the possibility of generating stresses due to thermal shock, a preheat stage in the soldering process is recommended, and the peak temperature of the solder process should be rigidly controlled.

When using a reflow process, care should be taken to ensure that the MLN chip is not subjected to a thermal gradient steeper than 4 degrees per second; the ideal gradient being 2 degrees per second. During the soldering process, preheating to within 100 degrees of the solder's peak temperature is essential to minimize thermal shock.

Once the soldering process has been completed, it is still necessary to ensure that any further thermal shocks are avoided. One possible cause of thermal shock is hot printed circuit boards being removed from the solder process and subjected to cleaning solvents at room temperature. The boards must be allowed to cool gradually to less than 50°C before cleaning.

### Reflow Solder Profile

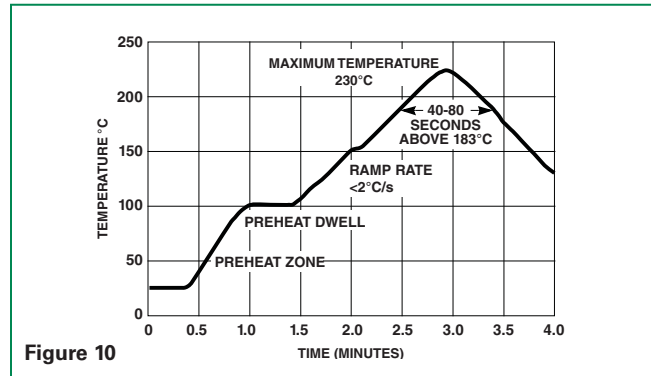


Figure 10

### Wave Solder Profile

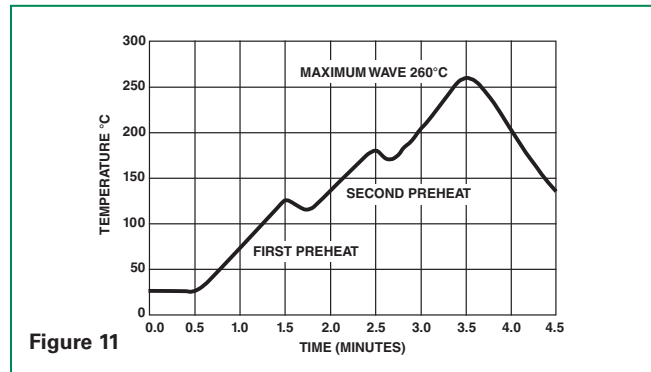
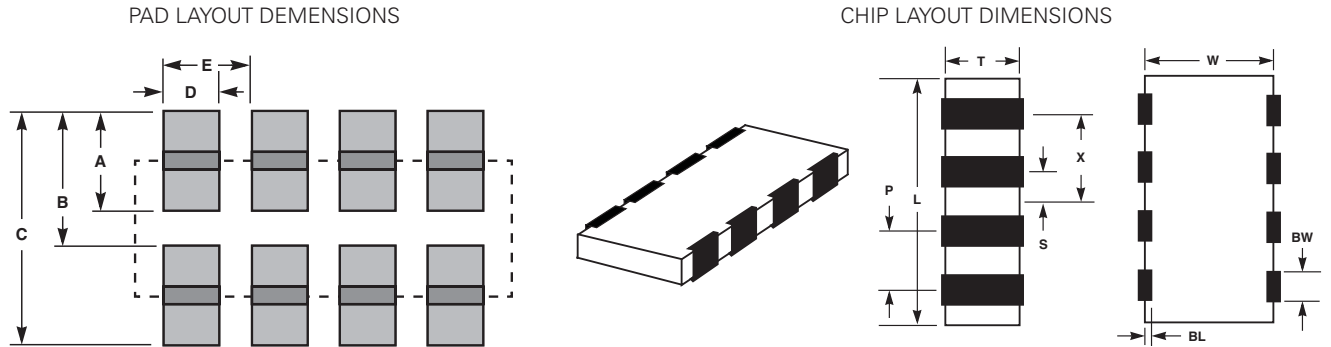


Figure 11

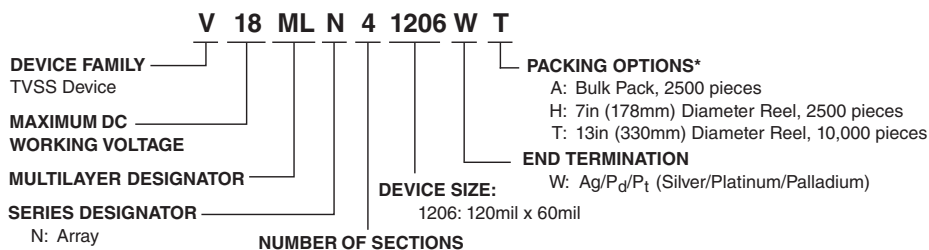
### Product Dimensions (mm)



Dimension	1206 Size	
	IN	MM
<b>A</b>	0.890	0.035
<b>B</b>	1.650	0.065
<b>C</b>	2.540	0.100
<b>D</b>	0.460	0.018
<b>E</b>	0.790	0.030
<b>L</b>	0.126 $\pm$ 0.008	3.200 $\pm$ 0.200
<b>W</b>	0.063 $\pm$ 0.008	1.600 $\pm$ 0.200
<b>T</b>	0.053 Max	1.350 Max
<b>BW</b>	0.016 $\pm$ 0.004	0.410 $\pm$ 0.100
<b>BL</b>	0.007 +0.01/- 0.002	0.180 +0.25/-0.050
<b>P</b>	0.030 Ref	0.760 Ref
<b>X</b>	0.045 $\pm$ 0.004	1.400 $\pm$ 0.100
<b>S</b>	0.015 $\pm$ 0.004	0.380 $\pm$ 0.100

MLN Series

### Part Numbering System

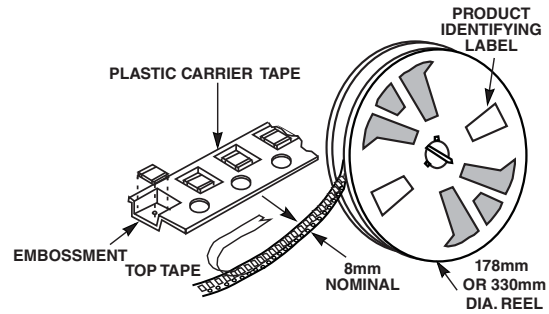
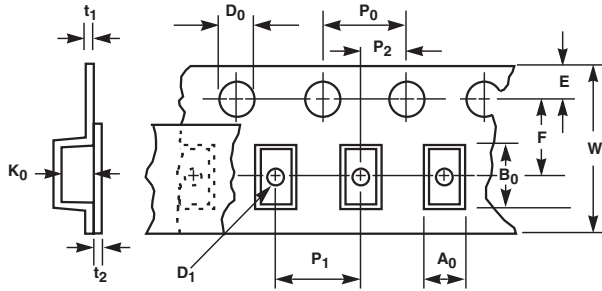


### Packaging\*

Device Size	Quantity		
	13" Inch Reel ("T" Option)	7" Inch Reel ("H" Option)	Bulk Pack ("A" Option)
1206	10,000	2,500	2,500

\*(Packaging) It is recommended that parts be kept in the sealed bag provided and that parts be used as soon as possible when removed from bags.

### Tape and Reel Specifications



Symbol	Description	Dimensions in Millimeters
$A_0$	Width of Cavity	Dependent on Chip Size to Minimize Rotation.
$B_0$	Length of Cavity	Dependent on Chip Size to Minimize Rotation.
$K_0$	Depth of Cavity	Dependent on Chip Size to Minimize Rotation.
$W$	Width of Tape	8 -/+0.2
$F$	Distance Between Drive Hole Centers and Cavity Centers	3.5 -/+0.5
$E$	Distance Between Drive Hole Centers and Tape Edge	1.75 -/+0.1
$P_1$	Distance Between Cavity Center	4 -/+0.1
$P_2$	Axial Distance Between Drive Hole Centers and Cavity Centers	2 -/+0.1
$P_0$	Axial Distance Between Drive Hole Centers	4 -/+0.1
$D_0$	Drive Hole Diameter	1.55 -/+0.05
$D_1$	Diameter of Cavity Piercing	1.05 -/+0.05
$T_1$	Embossed Tape Thickness	0.3 Max
$T_2$	Top Tape Thickness	0.1 Max

Notes :

- Conforms to EIA-481-1, Revision A
- Can be supplied to IEC publication 286-3



### RoHS AUML Varistor Series



#### Size Table

Metric	EIA
3216	1206
3225	1210
4532	1812
5650	2220

#### Applications

- Suppression of inductive switching or other transient events such as EFT and surge voltage at the circuit board level
- ESD protection for components sensitive to IEC 61000-4-2, MIL-STD-883C, Method 3015.7, and other industry specifications (See Also the MLE or MLN Series)
- Provides on-board transient voltage protection for ICs and transistors
- Used to help achieve electromagnetic compliance of end products
- Replace larger surface mount TVS Zeners in many applications

#### Description

The AUML Series of Multilayer Transient Surge Suppressors was specifically designed to suppress the destructive transient voltages found in an automobile. The most common transient condition results from large inductive energy discharges. The electronic systems in the automobile, e.g. antilock brake systems, direct ignition systems, engine control, airbag control systems, wiper motor controls, etc., are susceptible to damage from these voltage transients and thus require protection. The AUML transient suppressors have temperature independent suppression characteristics affording protection from -55°C to 125°C.

The AUML suppressor is manufactured from semiconducting ceramics which offer rugged protection and excellent transient energy absorption in a small package. The devices are available in ceramic leadless chip form, eliminating lead inductance and assuring fast speed of response to transient surges. These Suppressors require significantly smaller space and land pads than Silicon TVS diodes, offering greater circuit board layout flexibility for the designer.

Also see the Littelfuse ML, MLN and MLE Series of Multilayer Suppressors.

#### Features

- AEC - Q200 compliant
- RoHS Compliant
- Load Dump energy rated per SAE Specification J1113
- Leadless, surface mount chip form
- "Zero" Lead Inductance
- Variety of energy ratings available
- No temperature derating up to 125°C ambient
- High peak surge current capability
- Low Profile, compact industry standard chip size; (1206, 1210, 1812 and 2220 Sizes)
- Inherent bidirectional clamping
- No Plastic or epoxy packaging assures better than 94V-0 flammability rating

#### Absolute Maximum Ratings

• For ratings of individual members of a series, see Device Ratings and Specifications chart.

Continuous	AUML Series	Units
Steady State Applied Voltage:		
DC Voltage Range ( $V_{MIDC}$ )	18	V
Transient:		
Load Dump Energy, ( $W_{LD}$ )	1.5 to 25	J
Jump Start Capability (5 minutes), ( $V_{JUMP}$ )	24.5	V
Operating Ambient Temperature Range ( $T_A$ )	-55 to +125	°C
Storage Temperature Range ( $T_{STG}$ )	-55 to +150	°C
Temperature Coefficient ( $\alpha V$ ) of Clamping Voltage ( $V_C$ ) at Specified Test Current	<0.01	%/°C

**CAUTION:** Stresses above those listed in "Absolute Maximum Ratings" may cause permanent damage to the device. This is a stress only rating and operation of the device at these or any other conditions above those indicated in the operational sections of this specification is not implied.

©2009 Littelfuse, Inc.

Specifications are subject to change without notice.

Please refer to [www.littelfuse.com/series/AUML.html](http://www.littelfuse.com/series/AUML.html) for current information.

### Device Ratings and Specifications

Part Number	Maximum Ratings (125°C)			Specifications (25°C)				
	Maximum Continuous DC Voltage	Jump Start Voltage (5 Min)	Load Dump Energy (10 Pulses)	Nominal Varistor Voltage at 10mA DC Test Current		Maximum Standby Leakage (at 13V DC)	Maximum Clamping Voltage (V <sub>C</sub> ) at Test Current (8/20μs)	
	V <sub>M(DC)</sub> (V)	V <sub>JUMP</sub> (V)	W <sub>LD</sub> (J)	V <sub>N(DC)</sub> Min (V)	V <sub>N(DC)</sub> Max (V)	I <sub>L</sub> (μA)	V <sub>C</sub> (V)	I <sub>P</sub> (A)
V18AUMLA1206	18	24.5	1.5	23	32	50	40	1.5
V18AUMLA1210	18	24.5	3.0	23	32	50	40	1.5
V18AUMLA1812	18	24.5	6.0	23	32	100	40	5.0
V18AUMLA2220	18	24.5	25	23	32	200	40	10.0

For automotive 24V and 42V applications please contact your Littelfuse representative or visit [www.littelfuse.com](http://www.littelfuse.com) for the latest product update.

**NOTES:**

1. Average power dissipation of transients not to exceed 0.1W, 0.15W, 0.3W and 1W for model sizes 1206, 1210, 1812 and 2220 respectively.
2. Load Dump energy rating (into the suppressor) of a voltage transient with a resultant time constant of 115ms to 230ms.
3. Thermal shock capability per Mil-Std-750, Method 1051: -55°C to 125°C, 5 minutes at 25°C, 25 Cycles: 15 minutes at each extreme.
4. For application specific requirements, please contact Littelfuse.

### Current, Energy and Power Derating Curve

When transients occur in rapid succession, the average power dissipation is the energy (watt-seconds) per pulse times the number of pulses per second. The power so developed must be within the specifications shown on the Device Ratings and Characteristics Table for the specific device. Certain parameter ratings must be derated at high temperatures as shown below.

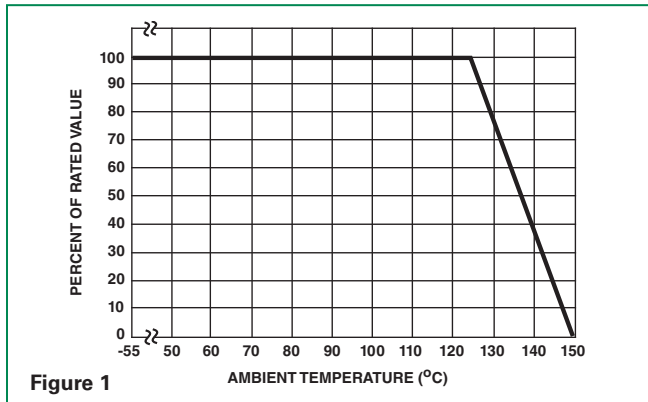


Figure 1

### Peak Pulse Current Test Waveform for Clamping Voltage

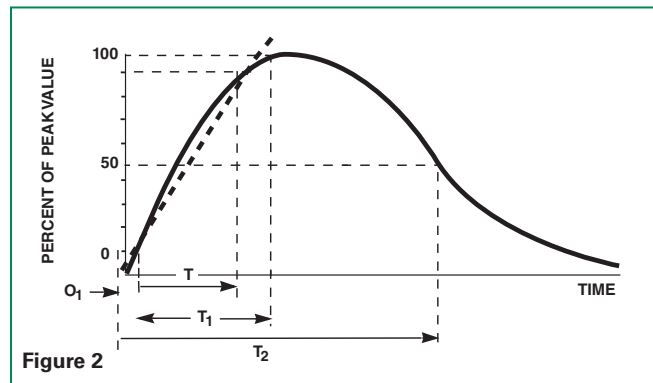


Figure 2

- O<sub>1</sub> = Virtual Origin of Wave
- T = Time from 10% to 90% of Peak
- T<sub>1</sub> = Rise Time = 1.25 × T
- T<sub>2</sub> = Decay Time

**Example** - For an 8/20 μs Current Waveform:

- 8μs = T<sub>1</sub> = Rise Time
- 20μs = T<sub>2</sub> = Decay Time

### Maximum Leakage Current/Clamping Voltage Curve for AUML Series at 25°C

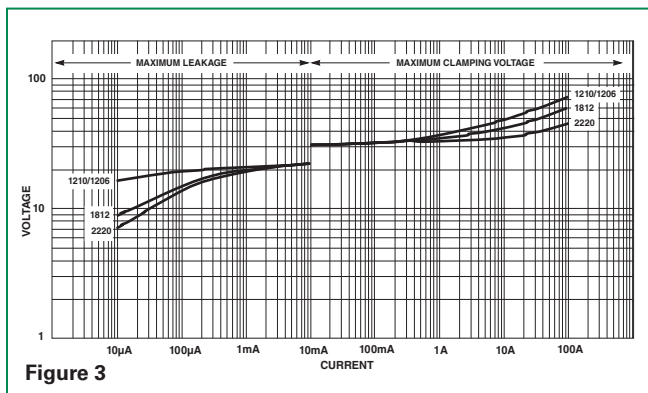


Figure 3

### Typical V-I Characteristics of the V18AUMLA2220 at -40°C, 25°C, 85°C and 125°C

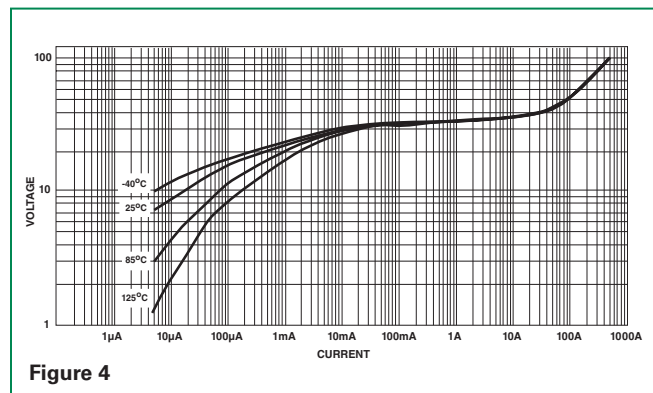


Figure 4

### Temperature Effects

In the leakage region of the AUML suppressor, the device characteristics approaches a linear (ohmic) relationship and shows a temperature dependent affect. In this region the suppressor is in a high resistance mode (approaching  $10^6\Omega$ ) and appears as a near open-circuit. Leakage currents at maximum rated voltage are in the microamp range. When clamping transients at higher currents (at and above

the 10mA range), the AUML suppressor approaches a 1-10 characteristic. In this region the characteristics of the AUML are virtually temperature independent. Figure 3 shows the typical effect of temperature on the V-I characteristics of the AUML suppressor.

### Load Dump Energy Capability

A Load Dump transient occurs when the alternator load in the automobile is abruptly reduced. The worst case scenario of this transient occurs when the battery is disconnected while operating at full rated load. There are a number of different Load Dump specifications in existence in the automotive industry, with the most common one being that recommended by the Society of Automotive Engineers, specification #SAE J1113. Because of the diversity of these Load Dump specifications Littelfuse defines the Load Dump energy capability of the AUML suppressor range as that energy dissipated by the device itself, independent of the test circuit setup. The resultant Load Dump energy handling capability serves as an excellent figure of merit for the AUML suppressor. Standard Load Dump specifications require a device capability of 10 pulses at rated energy, across a temperature range of  $-40^\circ\text{C}$  to  $+125^\circ\text{C}$ . This capability requirement is well within the ratings of all of the AUML Series (Figure 6 on next page).

Further testing on the AUML Series has concentrated on extending the number of Load Dump pulses, at rated energy, which are applied to the devices. The reliability information thus generated gives an indication of the inherent capability of these devices. As an example of device durability the 1210 size has been subjected to over 2000 pulses at its rated energy of 3 joules (J); the 1812 size has been pulsed over 1000 times at 6J and 2220 size has been pulsed at its rated energy of 25J over 300 times. In all cases there has been little or no change in the device characteristics (Figure 7 on next page).

The very high energy absorption capability of the AUML suppressor is achieved by means of a highly controlled manufacturing process. This technology ensures that a large volume of suppressor material, with an interdigitated layer construction, is available for energy absorption in an extremely small package. Unlike equivalent rated Silicon TVS diodes, the entire AUML device volume is available to dissipate the Load Dump energy.

Hence, the peak temperatures generated by the Load Dump transient are significantly lower and evenly dissipated throughout the complete device (Figure 5 below). This even energy dissipation ensures that there are lower peak temperatures generated at the P-N grain boundaries of the AUML suppressor.

There are a number of different size devices available in the AUML Series, each one with a load dump energy rating, which is size dependent.

Experience has shown that while the effects of a load dump transient is of real concern, its frequency of occurrence is much less than that of low energy inductive spikes. Such low energy inductive spikes may be generated as a result of motors switching on and off, from ESD occurrences, fuse blowing, etc. It is essential that the suppression technology selected also has the capability to suppress such transients. Testing on the V18AUMLA2220 has shown that after being subjected to a repetitive energy pulse of 2J, over 6000 times, no characteristic changes have occurred (Figure 8 on next page).

### Speed of Response

The clamping action of the AUML suppressor depends on a conduction mechanism similar to that of other semiconductor devices (i.e. P-N Junctions). The apparent slow response time often associated with transient voltage suppressors (Zeners, MOVs) is often due to parasitic inductance in the package and leads of the device and less dependent of the basic material (Silicon,  $Z_{\text{N}}\text{O}$ ). Thus, the single most critical element affecting the response time of any suppressor is its lead inductance. The AUML suppressor is a surface mount device, with no leads or external packaging, and thus, it has virtually zero inductance. The actual response time of a AUML surge suppressor is in the 1 to 5 ns range, more than sufficient for the transients which are likely to be encountered in an automotive environment.

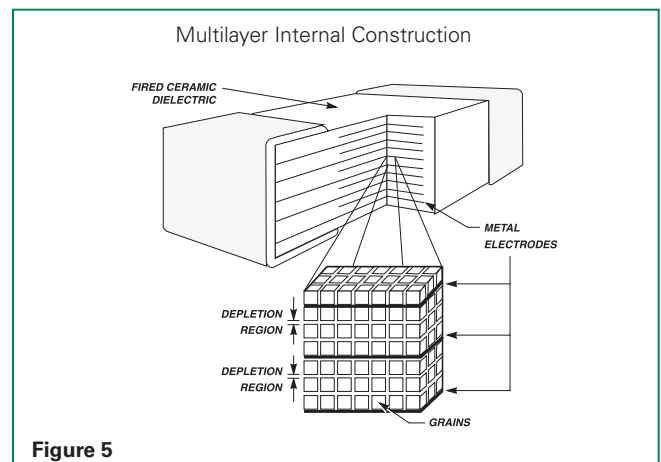


Figure 5

**AUML Load Dump Pulsing over a Temperature Range of -55°C to +125°C**

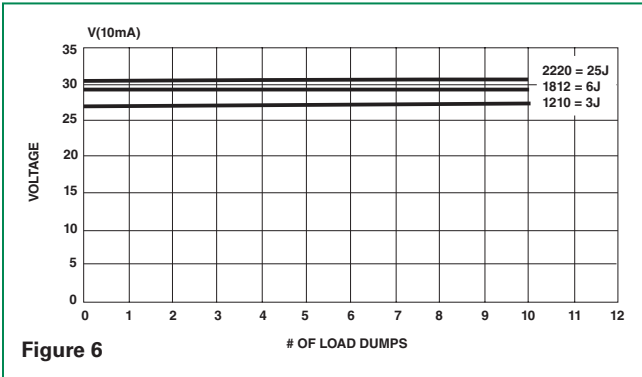


Figure 6

**Repetitive Load Dump Pulsing at Rated Energy**

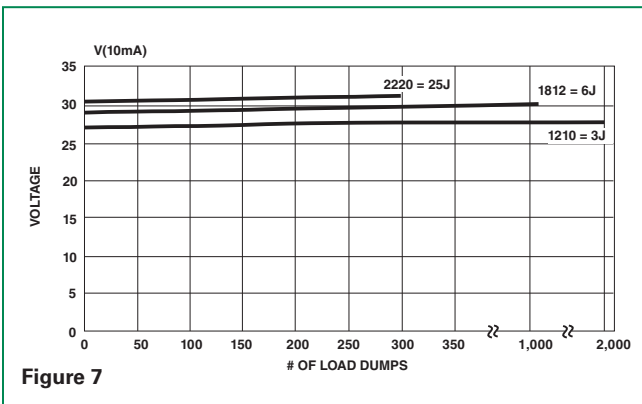


Figure 7

**Repetitive Energy Testing of V18AUMLA2220 at an Energy Level of 2 Joules**

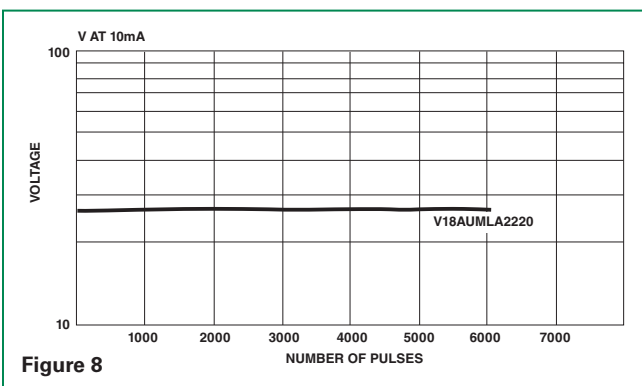


Figure 8

### Lead (Pb) Soldering Recommendations

The principal techniques used for the soldering of components in surface mount technology are IR Re-flow and Wave soldering. Typical profiles are shown on the right.

The termination option available for each solder technique is:

Reflow	Wave
1. Nickel Barrier (preferred)	1. Nickel Barrier (preferred)
2. Silver/Platinum	

The recommended solder for the AUML suppressor is a 62/36/2 (Sn/Pb/Ag), 60/40 (Sn/Pb) or 63/37 (Sn/Pb). Littelfuse also recommends an RMA solder flux.

Wave soldering is the most strenuous of the processes. To avoid the possibility of generating stresses due to thermal shock, a preheat stage in the soldering process is recommended, and the peak temperature of the solder process should be rigidly controlled.

When using a reflow process, care should be taken to ensure that the AUML chip is not subjected to a thermal gradient steeper than 4 degrees per second; the ideal gradient being 2 degrees per second. During the soldering process, preheating to within 100 degrees of the solder's peak temperature is essential to minimize thermal shock.

Once the soldering process has been completed, it is still necessary to ensure that any further thermal shocks are avoided. One possible cause of thermal shock is hot printed circuit boards being removed from the solder process and subjected to cleaning solvents at room temperature. The boards must be allowed to cool gradually to less than 50°C before cleaning.

### Reflow Solder Profile

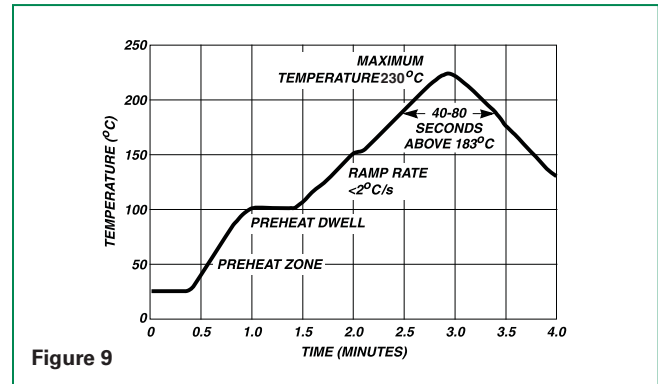


Figure 9

### Wave Solder Profile

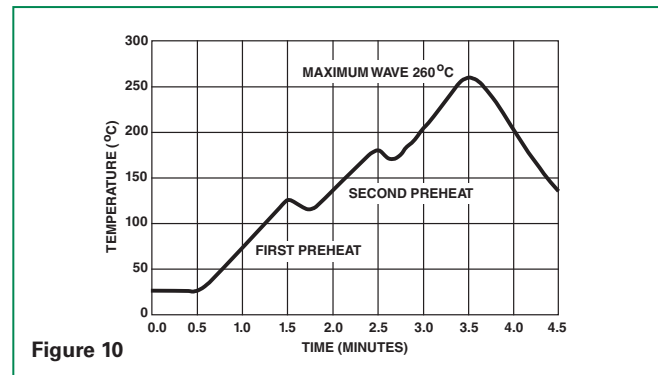


Figure 10

### Lead-free (Pb-free) Soldering Recommendations

Littelfuse offers the Nickel Barrier Termination finish for the optimum Lead-free solder performance.

The preferred solder is 96.5/3.0/0.5 (SnAgCu) with an RMA flux, but there is a wide selection of pastes and fluxes available with which the Nickel Barrier parts should be compatible.

The reflow profile must be constrained by the maximums in the Lead-free Reflow Profile. For Lead-free Wave soldering, the Wave Solder Profile still applies.

Note: the Lead-free paste, flux and profile were used for evaluation purposes by Littelfuse, based upon industry standards and practices. There are multiple choices of all three available, it is advised that the customer explores the optimum combination for their process as processes vary considerably from site to site.

### Lead-free Re-flow Solder Profile

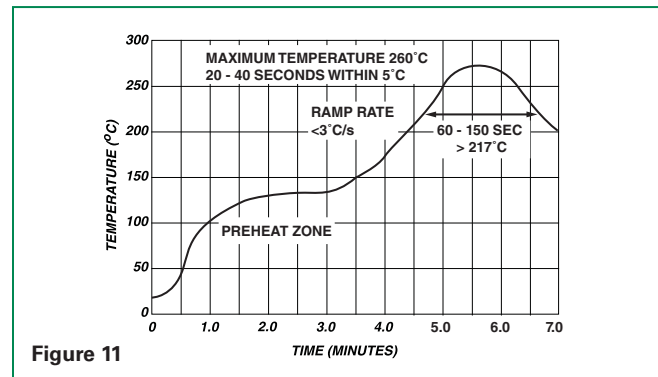
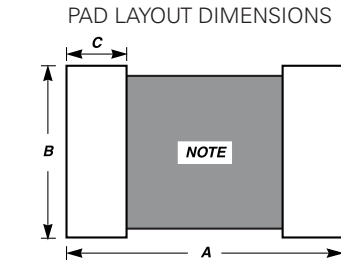
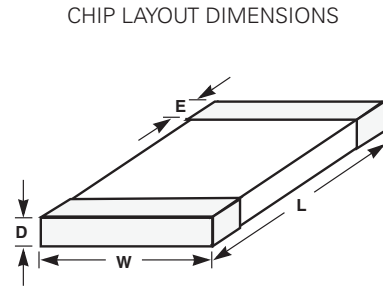


Figure 11

### Product Dimensions (mm)



Note: Avoid metal runs in this area, parts are not recommended for use in applications using Silver (Ag) epoxy paste.



SYMBOL	1206 Size		1210 Size		1812 Size		2220 Size	
	IN	MM	IN	MM	IN	MM	IN	MM
<b>A</b>	0.203	5.150	0.219	5.510	0.272	6.910	0.315	8.000
<b>B</b>	0.103	2.620	0.147	3.730	0.172	4.360	0.240	6.190
<b>C</b>	0.065	1.650	0.073	1.850	0.073	1.850	0.073	1.850
<b>D (max.)</b>	0.071	1.80	0.070	1.80	0.07	1.80	0.118	3.00
<b>E</b>	0.020 +/- 0.010	0.50 +/- 0.25	0.020 +/- 0.010	0.50 +/- 0.25	0.020 +/- 0.010	0.50 +/- 0.25	0.030 +/- 0.010	0.75 +/- 0.25
<b>L</b>	0.125 +/- 0.012	3.20 +/- 0.03	0.125 +/- 0.012	3.20 +/- 0.30	0.180 +/- 0.014	4.50 +/- 0.35	0.225 +/- 0.016	5.70 +/- 0.40
<b>W</b>	0.060 +/- 0.011	1.60 +/- 0.28	0.100 +/- 0.012	2.54 +/- 0.30	0.125 +/- 0.012	3.20 +/- 0.30	0.197 +/- 0.016	5.00 +/- 0.40

A Load Dump transient occurs when the alternator load in the automobile is abruptly reduced. The worst case scenario of this transient occurs when the battery is disconnected while operating at full rated load. There are a number of different Load Dump specifications in existence in the automotive industry, with the most common one being that recommended by the Society of Automotive Engineers, specification #SAE J1113. Because of the diversity of these Load Dump specifications Littelfuse defines the Load Dump energy capability of

the AUML suppressor range as that energy dissipated by the device itself, independent of the test circuit setup. The resultant Load Dump energy handling capability serves as an excellent figure of merit for the AUML suppressor. Standard Load Dump specifications require a device capability of 10 pulses at rated energy, across a temperature range of -40°C to +125°C. This capability requirement is well within the ratings of all of the AUML Series (Figure 5).

### Explanation of Terms

#### Maximum Continuous DC Working Voltage (\* $V_{M(DC)+}$ )

This is the maximum continuous DC voltage which may be applied, up to the maximum operating temperature (125°C), to the ML suppressor. This voltage is used as the reference test point for leakage current and is always less than the breakdown voltage of the device.

#### Load Dump Energy Rating \* $W_{LD+}$

This is the actual energy the part is rated to dissipate under Load Dump conditions (not to be confused with the "source energy" of a Load Dump test specification).

#### Maximum Clamping Voltage \* $V_{C+}$

This is the peak voltage appearing across the suppressor when measured at conditions of specified pulse current and specified waveform (8/20µs). It is important to note that the peak current and peak voltage may not necessarily be coincidental in time.

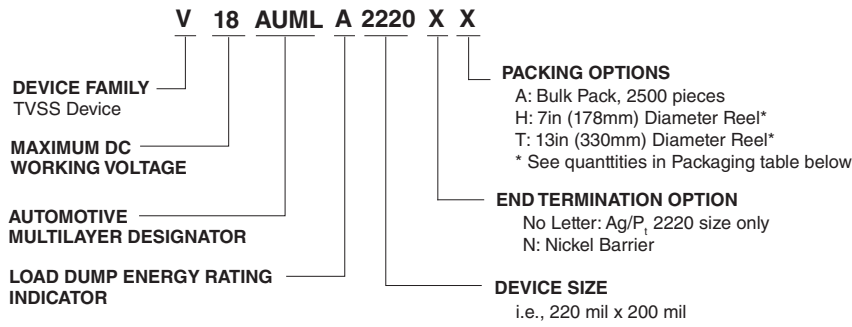
#### Leakage Current \* $I_{L+}$

In the nonconducting mode, the device is at a very high impedance (approaching 10<sup>9</sup>Ω at its rated working voltage) and appears as an almost open circuit in the system. The leakage current drawn at this level is very low (<25µA at ambient temperature) and, unlike the Zener diode, the multilayer TVS has the added advantage that, when operated up to its maximum temperature, its leakage current will not increase above 500µA.

#### Nominal Voltage \* $V_{N(DC)+}$

This is the voltage at which the AUML enters its conduction state and begins to suppress transients. In the automotive environment this voltage is defined at the 10mA point and has a minimum ( $V_{N(DC) MIN}$ ) and maximum ( $V_{N(DC) MAX}$ ) voltage specified.

**Part Numbering System**



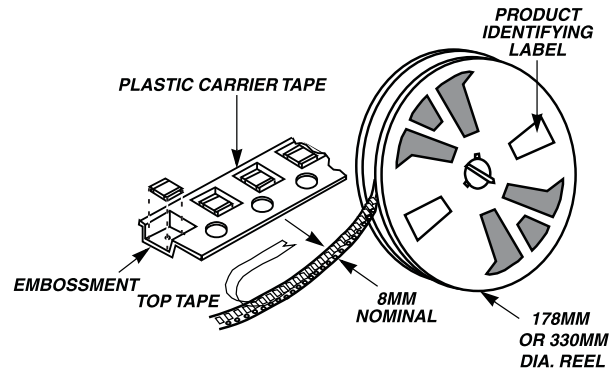
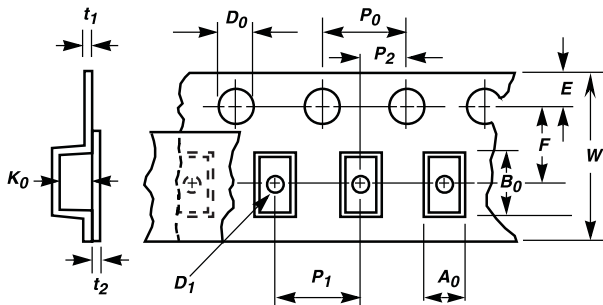
**Packaging\***

Device Size	Quantity		
	13" Inch Reel ('T' Option)	7" Inch Reel ('H' Option)	Bulk Pack ('A' Option)
1206	10,000	2,500	2,500
1210	8,000	2,000	2,000
1812	4,000	1,000	1,000
2220	4,000	1,000	1,000

\*(Packaging) It is recommended that parts be kept in the sealed bag provided and that parts be used as soon as possible when removed from bags.



### Tape and Reel Specifications



Symbol	Description	Dimensions in Millimeters	
$A_0$	Width of Cavity	Dependent on Chip Size to Minimize Rotation.	
$B_0$	Length of Cavity	Dependent on Chip Size to Minimize Rotation.	
$K_0$	Depth of Cavity	Dependent on Chip Size to Minimize Rotation.	
$W$	Width of Tape	8 +/- 0.2	12 +/- 0.2
$F$	Distance Between Drive Hole Centers and Cavity Centers	3.5 +/- 0.5	5.4 +/- 0.5
$E$	Distance Between Drive Hole Centers and Tape Edge	1.75 +/- 0.1	1.75 +/- 0.1
$P_1$	Distance Between Cavity Center	4 +/- 0.1	8 +/- 0.1
$P_2$	Axial Distance Between Drive Hole Centers and Cavity Centers	2 +/- 0.1	2 +/- 0.1
$P_0$	Axial Distance Between Drive Hole Centers	8 +/- 0.1	8 +/- 0.1
$D_0$	Drive Hole Diameter	1.55 +/- 0.05	1.55 +/- 0.05
$D_1$	Diameter of Cavity Piercing	1.05 +/- 0.05	1.55 +/- 0.05
$T_1$	Embossed Tape Thickness	0.3 Max	0.4 Max
$T_2$	Top Tape Thickness	0.1 Max	0.1 Max

NOTE: Dimensions in millimeters.

- Conforms to EIA-481-1, Revision A
- Can be supplied to IEC publication 286-3

Tape	8mm Wide Tape		12mm Wide Tape	
Chip Size	1206	1210	1812	2220

### Standard Packaging

Tape and reel is the standard packaging method of the AUML Series. The standard 300 millimeter (13-inch) reel utilized contains 4000 pieces for the 2200 and 1812 chips, 8000 pieces for the 1210 chip and 10,000 pieces for the 1206 size.

To order: add 'T' to the standard part number, e.g. V18AUMLA2220T.

### Special Packaging

**Option 1:** 178 millimeter (7-inch) reels containing 1000 (2220, 1812), 2000 (1210), 2500 (1206), pieces are available. To order add 'H' to the standard part number, e.g. V18AUMLA2220H.

**Option 2** For small sample quantities (less than 100 pieces) the units are shipped bulk pack. To order add 'A' to the standard part number, e.g. V18AUMLA2220A.

**RoHS CH Varistor Series**



**Description**

CH Series transient surge suppressors are small, metal-oxide varistors (MOVs) manufactured in leadless chip form. They are intended for use in a variety of applications from low voltage DC to off-line board-level protection. These devices, which have significantly lower profiles than traditional radial lead varistors, permit designers to reduce the size and weight and increase the reliability of their equipment designs.

CH Series varistors are available in a voltage range from 14V to 275V ( $V_{M(AC)RMS}$ ), and energy ratings up to 8J.

See the Littelfuse Multilayer Suppressor Series also.

**Agency Approvals**

Recognized under the components program of Underwriters Laboratories.

AGENCY	AGENCY FILE NUMBER
	UL E320116

**Features**

- Lead-free
- Leadless, surface mount chip in 5 x 8mm Size
- Voltage ratings  $V_{M(AC)RMS}$  14V to 275V
- Supplied in tape and reel or bulk pack
- No derating up to 125°C ambient

**Absolute Maximum Ratings**

• For ratings of individual members of a series, see Device Ratings and Specifications chart

Continuous	CH Series	Units
Steady State Applied Voltage:		
AC Voltage Range ( $V_{M(AC)RMS}$ )	14 to 275	V
DC Voltage Range ( $V_{M(DC)}$ )	18 to 369	V
Transient:		
Peak Pulse Current ( $I_{TM}$ )		
For 8/20 $\mu$ s Current (See Figure 2)	100 to 250	A
Single Pulse Energy Range		
For 10/1000 $\mu$ s Current Wave ( $W_{TM}$ )	1.0 to 8.0	J
Operating Ambient Temperature Range ( $T_A$ )	-55 to +125	°C
Storage Temperature Range ( $T_{STG}$ )	-55 to +150	°C
Temperature Coefficient ( $\alpha V$ ) of Clamping Voltage ( $V_C$ ) at Specified Test Current	<0.01	%/°C

*CAUTION: Stresses above those listed in "Absolute Maximum Ratings" may cause permanent damage to the device. This is a stress only rating and operation of the device at these or any other conditions above those indicated in the operational sections of this specification is not implied.*

CH Series

### Device Ratings and Specifications

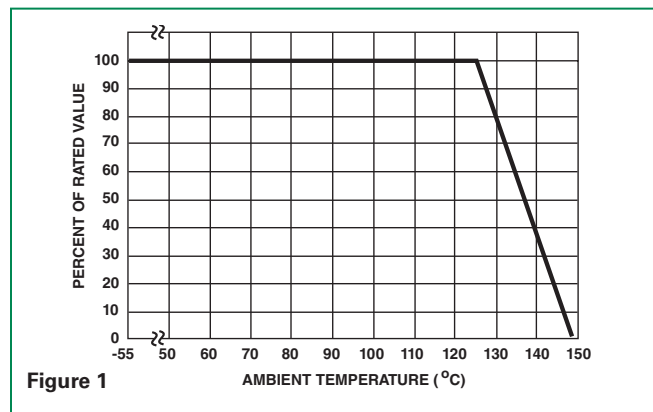
Part Number	Maximum Ratings (125°C)				Specifications (25°C)					
	Continuous		Transient		Varistor Voltage at 1 mA DC Test Current			Max Clamping Volt $V_C$ at Test Current (8/20 $\mu$ s)		Typical Capacitance
	$V_{RMS}$	$V_{DC}$	Energy (10/1000 $\mu$ s)	Peak Current (8/20 $\mu$ s)						
	$V_{M(AC)}$	$V_{M(DC)}$	$W_{TM}$	$I_{TM}$	MIN	$V_{N(DC)}$	MAX	$V_C$	$I_P$	f=1MHz
(V)	(V)	(J)	(A)	(V)	(V)	(V)	(V)	(A)	(pF)	
V22CH8	14	18 (Note 3)	1.0 (Note2)	100	18.7	22.0	26.0	47	5	1600
V27CH8	17	22	1.0	100	23.0	27.0	31.1	57	5	1300
V33CH8	20	26	1.0	100	29.5	33.0	36.5	68	5	1100
V39CH8	25	31	1.0	100	35.0	39.0	43.0	79	5	900
V47CH8	30	38	1.2	100	42.0	47.0	52.0	92	5	800
V56CH8	35	45	1.4	100	50.0	56.0	62.0	107	5	700
V68CH8	40	56	1.5	100	61.0	68.0	75.0	127	10	600
V120CH8	75	102	2.0	250	108.0	120.0	132.0	200	10	300
V150CH8	95	127	3.0	250	135.0	150.0	165.0	250	10	250
V180CH8	115	153	4.0	250	162.0	180.0	198.0	295	10	200
V200CH8	130	175	4.0	250	184.0	200.0	228.0	340	10	180
V220CH8	140	180	5.0	250	198.0	220.0	242.0	360	10	160
V240CH8	150	200	5.0	250	212.0	240.0	268.0	395	10	150
V360CH8	230	300	6.0	250	324.0	360.0	396.0	595	10	100
V390CH8	250	330	7.0	250	354.0	390.0	429.0	650	10	90
V430CH8	275	369	8.0	250	389.0	430.0	473.0	710	10	80

**NOTES:**

1. Power dissipation of transients not to exceed 0.25W.
2. Energy rating for impulse duration of 30ms minimum to one half of peak current value.
3. Also rated to withstand 24V for 5 minutes.
4. All Littelfuse CH Series Varistors are recognized under UL file #E320116 as a recognized component.

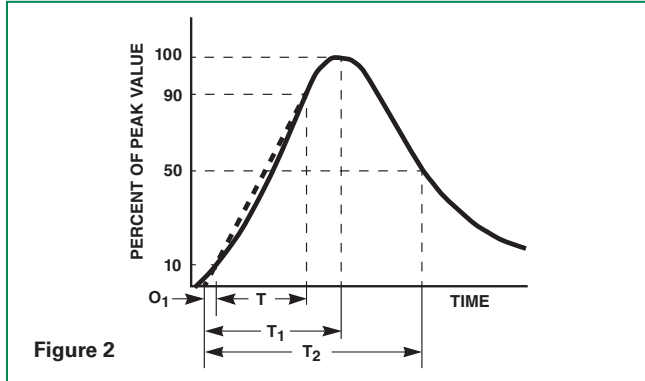
### Current, Energy and Power Derating Curve

Continuous power dissipation capability is not an applicable design requirement for a suppressor, unless transients occur in rapid succession. Under this condition, the average power dissipation required is simply the energy (watt-seconds) per pulse times the number of pulses per second. The power so developed must be within the specifications shown on the Device Ratings and Specifications Table for the specific device. Furthermore, the operating values need to be derated at high temperatures as shown in this diagram. Because varistors can only dissipate a relatively small amount of average power they are, therefore, not suitable for repetitive applications that involve substantial amounts of average power dissipation.



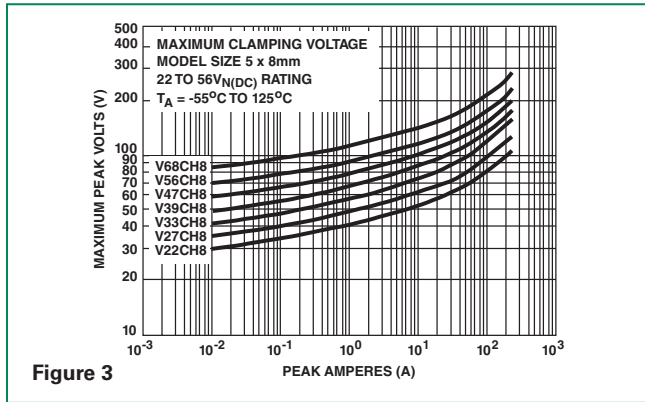
**Figure 1**

**Peak Pulse Current Test Waveform**

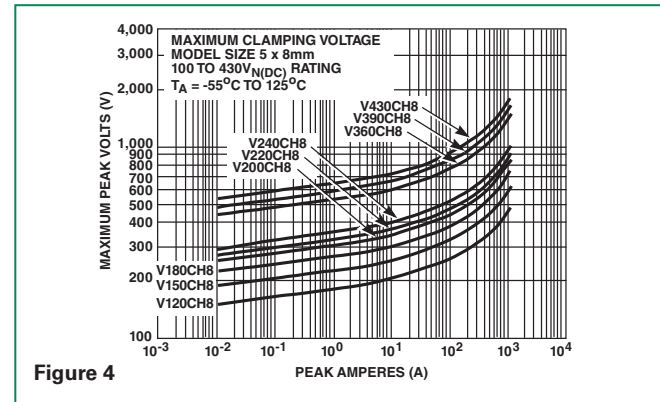


$O_1$  = Virtual Origin of Wave  
 $T$  = Time from 10% to 90% of Peak  
 $T_1$  = Rise Time =  $1.25 \times T$   
 $T_2$  = Decay Time  
**Example:**  
 For an  $8/20 \mu s$  Current Waveform:  
 $8 \mu s = T_1$  = Rise Time  
 $20 \mu s = T_2$  = Decay Time

**Clamping Voltage for V22CH8 – V68CH8**

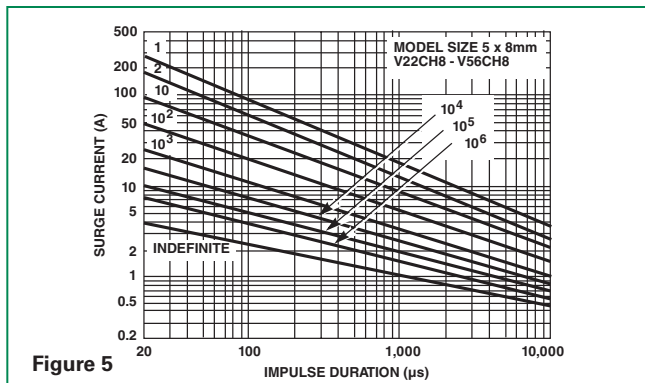


**Clamping Voltage for V120CH8 – V430CH8**

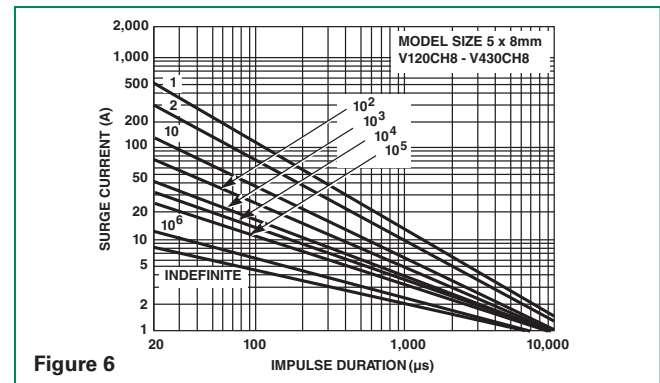


**Pulse Rating Curves**

**Surge Current Rating Curves for V22CH8 - V56CH8**



**Surge Current Rating Curves for V120CH8 - V430CH8**



NOTE: If pulse ratings are exceeded, a shift of  $V_{N(DC)}$  (at specified current) of more than  $\pm 10\%$  could result. This type of shift, which normally results in a decrease of  $V_{N(DC)}$ , may result in the device not meeting the original published specifications, but it does not prevent the device from continuing to function, and to provide ample protection.

### Lead (Pb) Soldering Recommendations

The principal techniques used for the soldering of components in surface mount technology are IR Re-flow and Wave soldering. Typical profiles are shown on the right.

The terminals of CH series devices are Platinum plated Silver (Ag/Pt), and the recommended solder is 62/36/2 (Sn/Pb/Ag), 60/40 (Sn/Pb) or 63/37 (Sn/Pb). Littelfuse also recommends an RMA solder flux.

Wave soldering is the most strenuous of the processes. To avoid the possibility of generating stresses due to thermal shock, a preheat stage in the soldering process is recommended, and the peak temperature of the solder process should be rigidly controlled.

When using a reflow process, care should be taken to ensure that the CH chip is not subjected to a thermal gradient steeper than 4 degrees per second; the ideal gradient being 2 degrees per second. During the soldering process, preheating to within 100 degrees of the solder's peak temperature is essential to minimize thermal shock.

Once the soldering process has been completed, it is still necessary to ensure that any further thermal shocks are avoided. One possible cause of thermal shock is hot printed circuit boards being removed from the solder process and subjected to cleaning solvents at room temperature. The boards must be allowed to cool gradually to less than 50°C before cleaning.

### Reflow Solder Profile

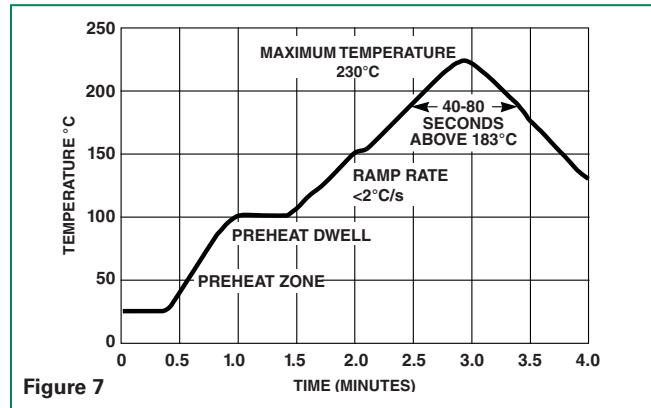


Figure 7

### Wave Solder Profile

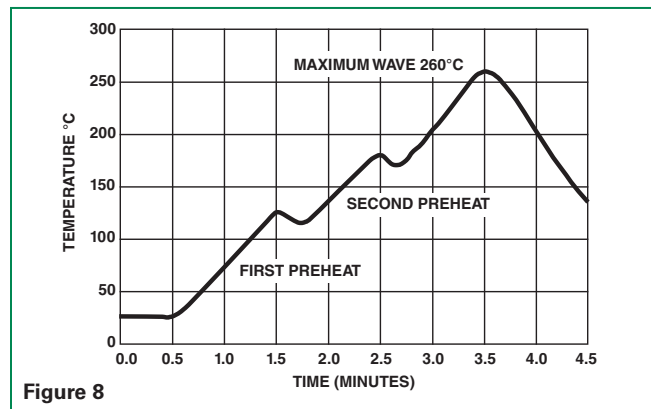


Figure 8

### Lead-free (Pb-free) Soldering Recommendations

The terminals of CH series devices are Platinum plated Silver (Ag/Pt), and the recommended Lead-free solder is 96.5/3.0/0.5 (SnAgCu) with an RMA flux, though there is a wide selection of pastes and fluxes available that should be compatible.

The reflow profile must be constrained by the maximums in the Lead-free Reflow Profile. For Lead-free Wave soldering, the Wave Solder Profile still applies.

Note: the Lead-free paste, flux and profile were used for evaluation purposes by Littelfuse, based upon industry standards and practices. There are multiple choices of all three available, it is advised that the customer explores the optimum combination for their process as processes vary considerably from site to site.

### Lead-free Re-flow Solder Profile

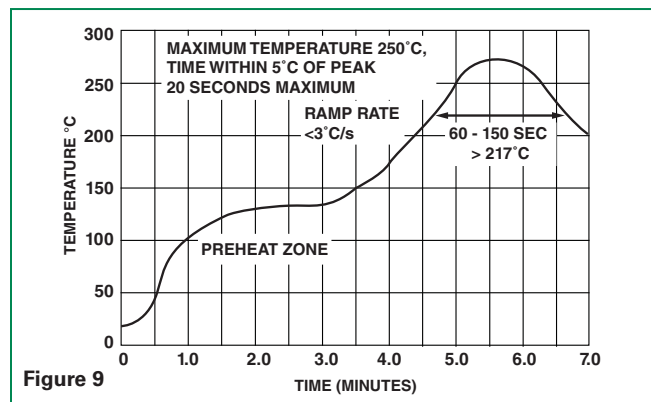
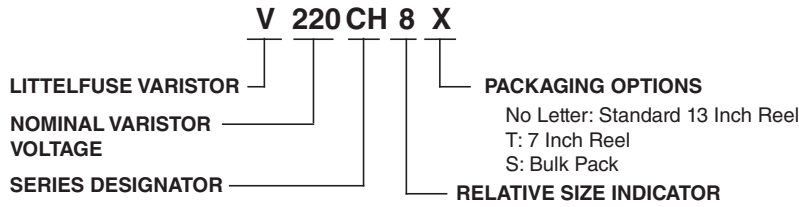


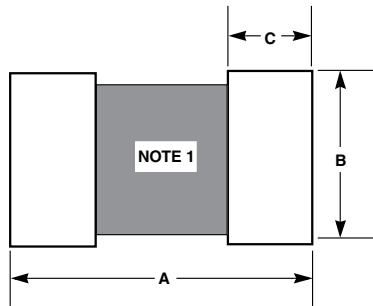
Figure 9

**Part Numbering System**



**Dimensions**

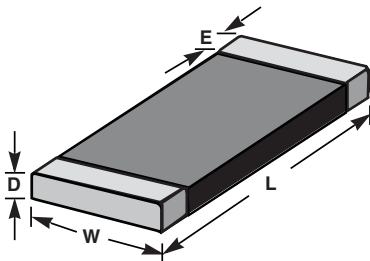
PAD LAYOUT DIMENSIONS



Symbol	Inches		Millimeters	
	Min	Max	Min	Max
A	0.402		10.210	
B	0.216		5.500	
C	0.087		2.210	
D	-	0.080	-	2.03
E	0.016	0.050	0.41	1.27
L	0.311	0.335	7.90	8.51
W	0.185	0.207	4.70	5.26

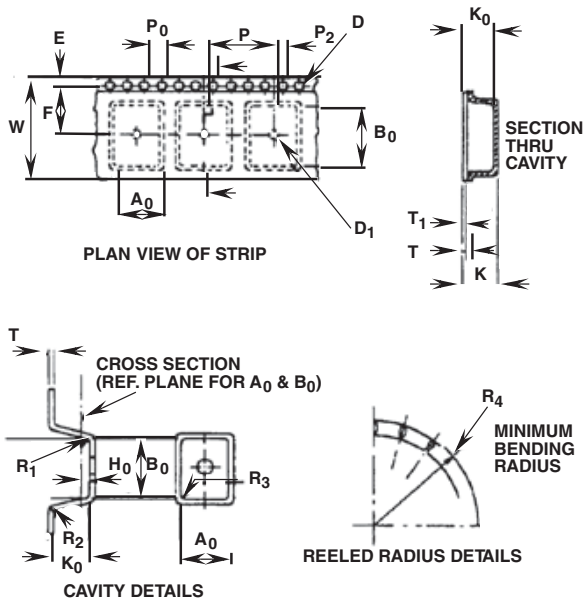
NOTE: Avoid metal runs in this area. Soldering recommendations: Material - 62/36/2 Sn/Pb/Ag or equivalent. Temperature – 230°C Max., 5s. Max. Flux - R.M.A.

CHIP LAYOUT DIMENSIONS



CH Series

### Tape and Reel Specifications



Symbol	Parameter	Size (mm)
$B_0$	Cavity Length	8.5 -/+ 0.1
$A_0$	Cavity Width	5.5 -/+ 0.1
$K_0$	Cavity Depth	2.0 Min.
$H_0$	Ref. Plane for $A_0$ and $B_0$	+ 0.10 0.3 - 0.05
$R_1, R_2, R_3$	Tape Cavity Radii	0.5 Max.
$T$	Carrier Tape Thickness	1.0 Max.
$T_1$	Cover Tape Thickness	0.1 Max.
$E$	Sprocket Hole from Edge	1.75 -/+ 0.1
$P_0$	Sprocket Hole Pitch	4.0 -/+ 0.1
$D$	Sprocket Hole Diameter	+ 0.1 1.5 - 0.0
$P_2$	Hole Centre to Component Centre	2.0 -/+ 0.15
$R_4$	Min. Bending Radius	30.5 Min.
$D_1$	Ejection Hole Diameter	1.5 Min.
$K$	Overall Thickness	3.0 Min.
$P$	Pitch Of Component	8.0 -/+ 0.1
$F$	Sprocket Hole to Ejection Hole	7.5 -/+ 0.1
$W$	Carrier Tape Width	16.0 -/+ 0.3

Notes :

- Conforms to EIA-481-1, Revision A
- Can be supplied to IEC Publication 286-3

### Standard Packaging\*

CH Series varistors are always shipped in tape and reel. The standard 13-inch reel utilized contains 4000 pieces.

Note also that the CH Series receives no branding on the chip itself.

\*NOTE: It is recommended that parts be kept in the sealed bag provided and that parts be used as soon as possible when removed from bags.

### Special Packaging

**Option 1** 7-inch reels containing 1000 pieces are available. To order 7-inch reels add a 'T' suffix to the part number; e.g., V47CH8T.

**Option 2** For small quantities (less than 100 pieces) the units are shipped bulk pack. To order, add a 'S' suffix to the part number; e.g., V47CH8S.



**RoHS**  **SM7 Varistor Series**

**Description**

The Littelfuse SM7 Series is a plastic-encapsulated surface-mount metal oxide varistor (MOV) transient voltage surge suppressor that is designed to be operated continuously across AC power lines.

The series comprises a Nylon molded package with tin plated lead frame for soldering to board. The surface mount SM7 Series is based on radial 7mm internal varistor element with similar characteristics to the Littelfuse LA / ZA series of varistor.

**Agency Approvals**

Agency	Agency File Number
	E320116

**Features**

- Electrical equivalent to leaded types LA/ZA series
- AC Voltage Rating 275 V to 510VAC rms
- No De-Rating up to 85°C ambient
- Good solderability
- Available in tape and reel
- Application of AC power meters

**Absolute Maximum Ratings**

• For ratings of individual members of a series, see Device Ratings and Specifications chart

Continuous	LA Series	Units
<b>Steady State Applied Voltage:</b>		
AC Voltage Range ( $V_{MI(AC)RMS}$ )	275 to 510	V
DC Voltage Range ( $V_{MI(DC)}$ )	369 to 675	V
<b>Transients:</b>		
Peak Pulse Current ( $I_{TM}$ )		
For 8/20 $\mu$ s Current Wave (See Figure 2)	1200	A
Single Pulse Energy Range		
For 10/1000 $\mu$ s Current Wave ( $W_{TM}$ )	23 to 40	J
Operating Ambient Temperature Range ( $T_A$ )	-40 to +85	°C
Storage Temperature Range ( $T_{STG}$ )	-55 to +125	°C
Temperature Coefficient ( $\alpha^v$ ) of Clamping Voltage ( $V_C$ ) at Specified Test Current	<0.01	%/°C
Hi-Pot Encapsulation (COATING Isolation Voltage Capability) (Dielectric must withstand indicated DC voltage for one minute per MIL-STD 202, Method 301)	2500	V
COATING Insulation Resistance	1000	M $\Omega$

**CAUTION:** Stresses above those listed in "Absolute Maximum Ratings" may cause permanent damage to the device. This is a stress only rating and operation of the device at these or any other conditions above those indicated in the operational sections of this specification is not implied.

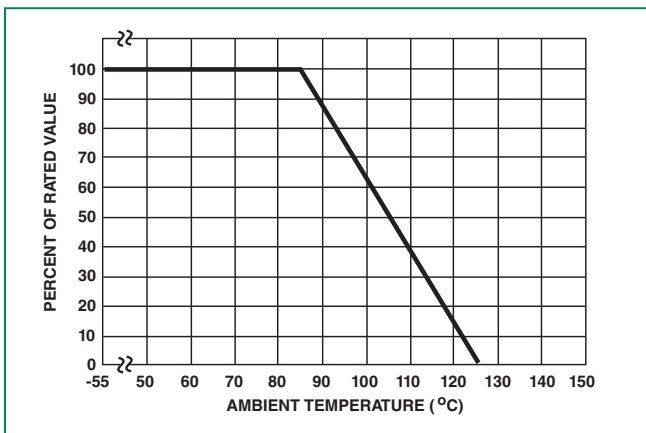
### LA Series Ratings & Specifications

Part Number	Maximum Rating (85°C)				Specifications (25°C)				
	Continuous		Transient		Varistor Voltage at 1mA DC Test Current		Maximum Clamping Voltage 8 x 20 μs		Typical Capacitance f = 1MHz
	V <sub>RMS</sub>	V <sub>DC</sub>	Energy 10 x 1000 μs	Peak Current 8 x 20 μs					
V <sub>M(AC)</sub> (V)	V <sub>M(DC)</sub> (V)	W <sub>TM</sub> (J)	I <sub>TM</sub> (A)	V <sub>NOM</sub> Min (V)	V <sub>NOM</sub> Max (V)	V <sub>C</sub> (V)	I <sub>PK</sub> (A)	C (pF)	
V275SM7 *	275	369	23	1200	389	473	710	10	80
V300SM7	300	405	25	1200	420	517	775	10	70
V320SM7	320	420	25	1200	462	565	850	10	65
V385SM7	385	505	27	1200	558	682	1025	10	60
V420SM7	420	560	30	1200	610	748	1120	10	55
V460SM7	460	615	37	1200	640	790	1190	10	55
V480SM7	480	640	35	1200	670	825	1240	10	50
V510SM7	510	675	40	1200	735	910	1200	10	45

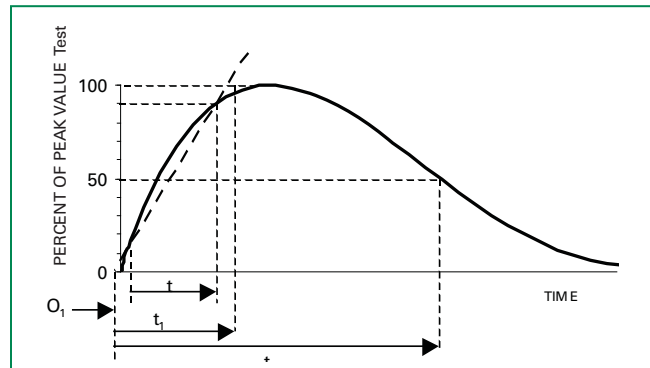
NOTE: V300-V510SM7 are recognized under UL file # E320116, agency certification in progress for V275SM7.

### Peak Current, Energy and Power Derating Curve

For applications exceeding 85°C ambient temperature, the peak surge current and energy ratings must be reduced as shown below



### Peak Pulse Current Test Waveform for Clamping Voltage

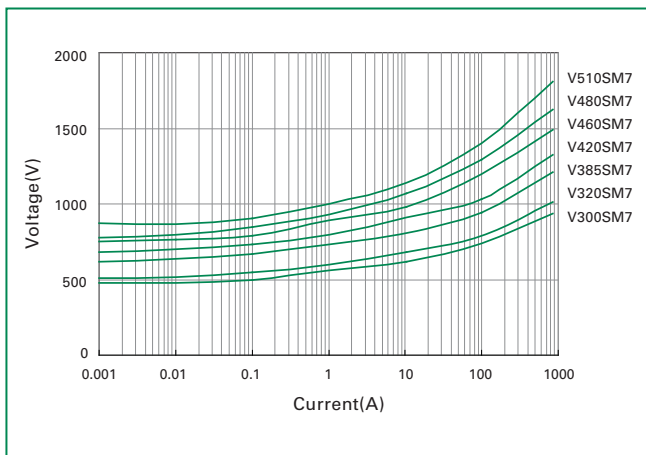


O<sub>1</sub> = Virtual Origin of Wave  
 T = Time from 10% to 90% of Peak  
 T<sub>1</sub> = Rise Time = 1.25 x T  
 T<sub>2</sub> = Decay Time

**Example** - For an 8/20 μs Current Waveform:

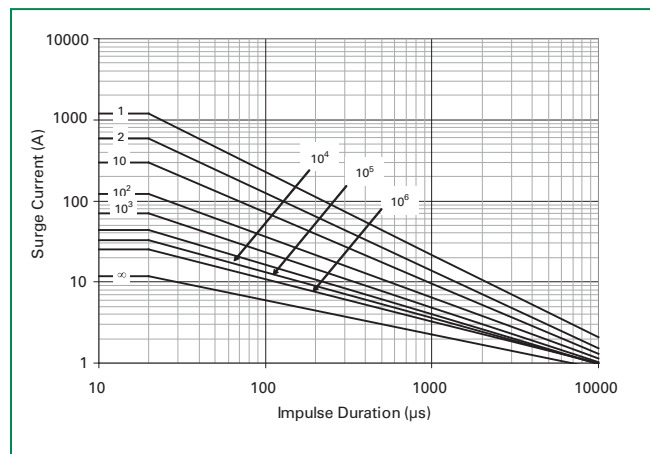
8 μs = T<sub>1</sub> = Rise Time  
 20 μs = T<sub>2</sub> = Decay Time

### V-I Limit Curves



NOTE: If pulse ratings are exceeded, a shift of V<sub>N(DC)</sub> (at specified current) of more than ±10% could result. This type of shift, which normally results in a decrease of V<sub>N(DC)</sub>, may result in the device not meeting the original published specifications, but it does not prevent the device from continuing to function, and to provide ample protection.

### Pulse Rating Curves



**Lead (Pb) Soldering Recommendations**

The principal techniques used for the soldering of components in surface mount technology are IR Re-flow and Wave soldering. Typical profiles are shown on the right.

The terminals of SM7 series devices are tin plated copper, and the recommended solder is 62/36/2 (Sn/Pb/Ag), 60/40 (Sn/Pb) or 63/37 (Sn/Pb). Littelfuse also recommends an RMA solder flux.

Wave soldering is the most strenuous of the processes. To avoid the possibility of generating stresses due to thermal shock, a preheat stage in the soldering process is recommended, and the peak temperature of the solder process should be rigidly controlled.

When using a reflow process, care should be taken to ensure that the SM7 chip is not subjected to a thermal gradient steeper than 4 degrees per second; the ideal gradient being 2 degrees per second. During the soldering process, preheating to within 100 degrees of the solder's peak temperature is essential to minimize thermal shock.

Once the soldering process has been completed, it is still necessary to ensure that any further thermal shocks are avoided. One possible cause of thermal shock is hot printed circuit boards being removed from the solder process and subjected to cleaning solvents at room temperature. The boards must be allowed to cool gradually to less than 50°C before cleaning.

**Reflow Solder Profile**

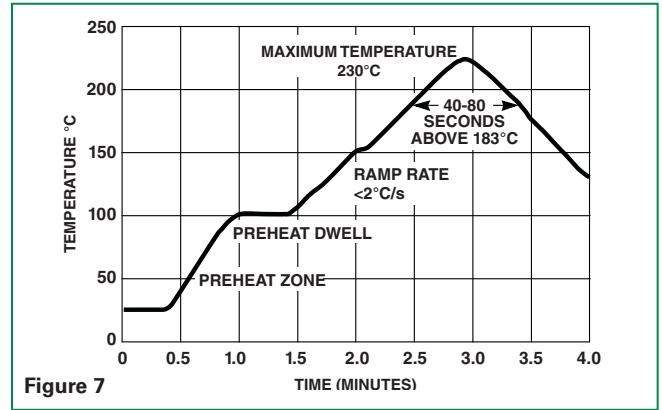


Figure 7

**Wave Solder Profile**

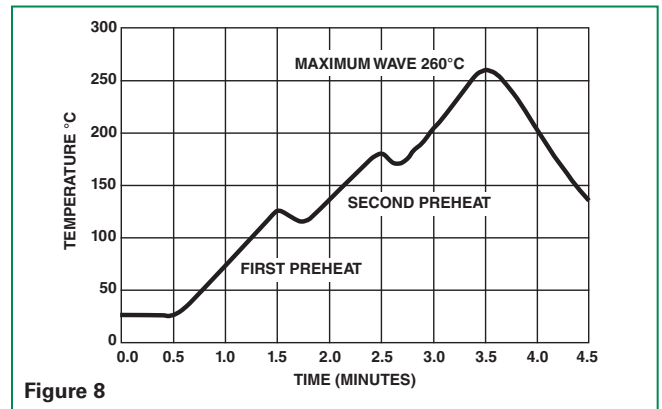


Figure 8

**Lead-free (Pb-free) Soldering Recommendations**

The terminals of SM7 series devices are tin plated copper, and the recommended Lead-free solder is 96.5/3.0/0.5 (SnAgCu) with an RMA flux, though there is a wide selection of pastes and fluxes available that should be compatible.

The reflow profile must be constrained by the maximums in the Lead-free Reflow Profile. For Lead-free Wave soldering, the Wave Solder Profile still applies.

Note: the Lead-free paste, flux and profile were used for evaluation purposes by Littelfuse, based upon industry standards and practices. There are multiple choices of all three available, it is advised that the customer explores the optimum combination for their process as processes vary considerably from site to site.

**Lead-free Re-flow Solder Profile**

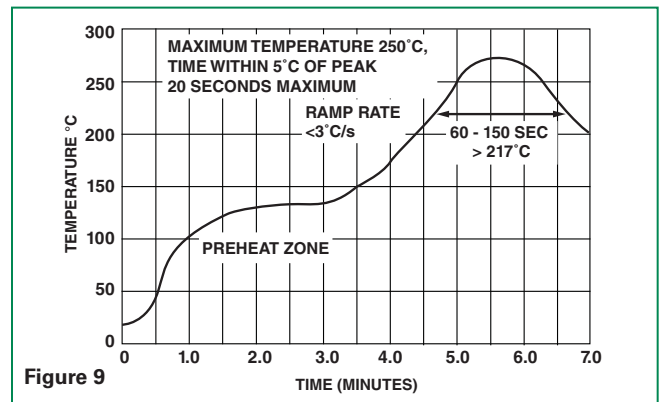
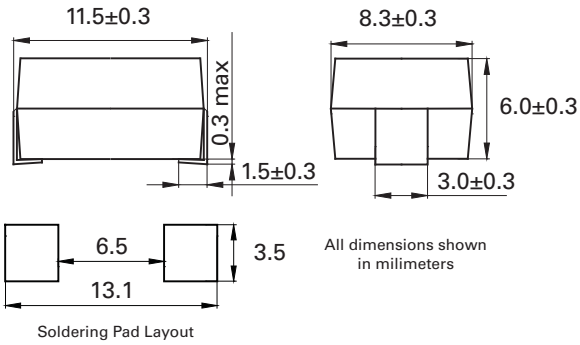
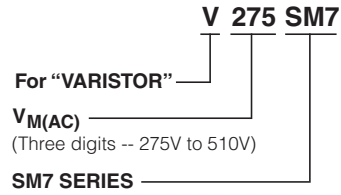


Figure 9

Product Dimensions

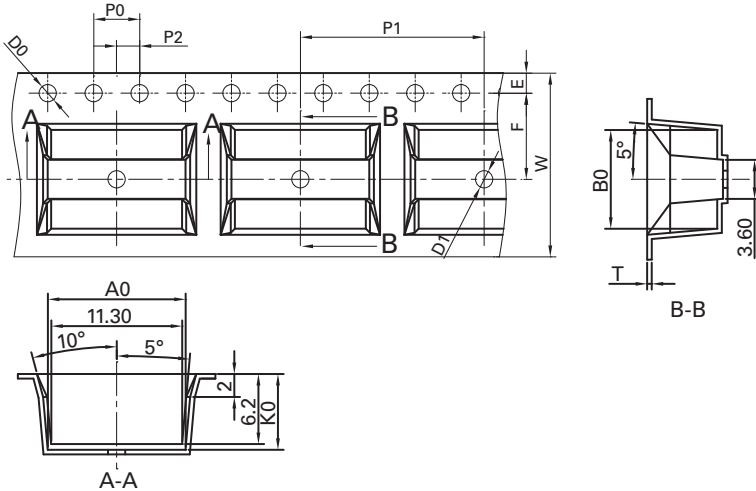


Part Numbering System



Tape & Reel Specifications

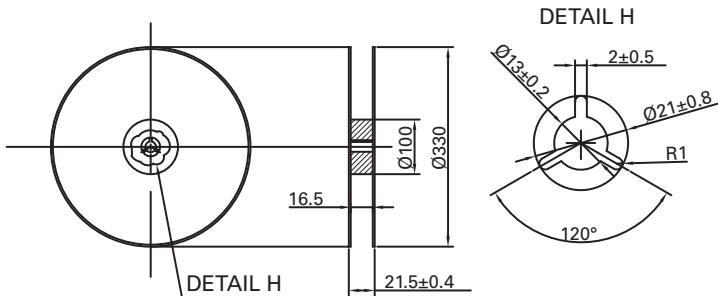
Carrier Tape



	mm
<b>W</b>	$16.00 \pm 0.30$
<b>T</b>	$0.40 \pm 0.05$
<b>A0</b>	$11.80 \pm 0.10$
<b>B0</b>	$8.60 \pm 0.10$
<b>K0</b>	$6.80 \pm 0.10$
<b>E</b>	$1.75 \pm 0.10$
<b>F</b>	$7.50 \pm 0.10$
<b>P0</b>	$4.00 \pm 0.10$
<b>P1</b>	$16.00 \pm 0.10$
<b>P2</b>	$2.00 \pm 0.10$
<b>D0</b>	$\phi 1.50 +0.10/-0$
<b>D1</b>	$\phi 1.50 +0.10/-0$

- NOTES:
- 1) All dimensions per EIA-481-c
  - 2) 10 pitches cumulative tolerance on tape  $\pm 0.20$ mm
  - 3) Quantity per 13 inch (330 mm) reel: 600 pcs

Plastic Reel



### RoHS TMOV® and iTMOV® Varistor Series



#### Description


The Littelfuse TMOV® and iTMOV® thermally protected varistors represent a new development in integrated circuit protection. Both versions are comprised of radial leaded MOVs (Metal Oxide Varistors) with an integrated thermally activated element designed to open in the event of overheating due to the abnormal overvoltage, limited current, conditions outlined in UL1449. The TMOV® and iTMOV® varistor's integrated thermal element, in conjunction with appropriate enclosure design, helps facilitate TVSS module compliance to UL1449 for both cord connected and permanently connected applications.

The TMOV® and iTMOV® varistors offer quick thermal response due to the close proximity of the integrated thermal element to the MOV body. The integrated configuration also offers lower inductance than most discrete solutions resulting in improved clamping performance to fast overvoltage transients.

The iTMOV® varistor differs from the TMOV® varistor by the inclusion of a third lead for the purpose of indicating that the MOV has been disconnected from the circuit. This lead facilitates connection to monitoring circuitry.

Additionally TMOV® and iTMOV® varistors are wave solderable, thus simplifying end product assembly by reducing the the expense and rework associated with hand soldering operations.

#### Agency Approvals

Agency Approval	Agency File Number	Standard		RoHS and Lead-free	
		14mm	20mm	14mm	20mm
 UL1414	E56529	√	√	√	√
 UL1449 <sup>4</sup>	E75961	√	√ <sup>1</sup>	√	√
 UL60691 (selected Tests)	E75961SP	N/A	√ <sup>2</sup>	N/A	No.3
 22.2-1	LR91788	√	√	Pending	Pending
 IEC - CECC Spec	QC42201-X0001	√	√ <sup>3</sup>	√	√
 IEC - CECC Spec	40021525	√	√	√	√

1. Devices with ratings greater than 420VAC are not affected by these abnormal voltage conditions.

2. Regarding thermal cut-offs for ratings up to 420VAC.

3. Under evaluation

4. 'Compliant to UL1449 2nd Edition. 3rd edition pending'.

Accelerated Age Testing: Devices comply with Accelerated aging test requirements per ANSI/IEEE C62.11 and may be used in secondary surge arresters without repeating this test.

#### Applications

- TVSS Products
- AC Panel Protection Modules
- AC Line Power Supplies
- Surge Protected Strip Connectors
- AC Power Meters
- Relocatable AC Power Taps
- GFCI (Ground Fault Current Interrupter)
- UPS (Uninterruptable Power Supply)
- White Goods
- Plug-in TVSS
- Inverters
- AC/DC Power Supplies

#### Features

- RoHS compliant and Lead-free available
- Patented integrated thermal protection device - Patent #US6636403
- Designed to facilitate compliance to UL1449 2nd Edition for TVSS product
- High peak surge current rating up to 10kA
- Wave solderable
- Standard lead form and spacing option
- Low leakage
- -55°C to +85°C operating temp range
- Three-lead version available for indication purposes

### Absolute Maximum Ratings

• For ratings of individual members of a series, see Device Ratings and Specifications chart

Continuous	TMOV® and iTMOV® Series	Units
Steady State Applied Voltage:		
AC Voltage Range ( $V_{M(A)C(R)M(S)}$ )	115 to 750	V
Transient:		
Peak Pulse Current ( $I_{TM}$ )		
For 8x20µs Current Wave, single pulse	6,000 to 10,000	A
Single-Pulse Energy Capability		
For 2ms Current Wave	35 to 480	J
Operating Ambient Temperature Range ( $T_A$ )	-55 to +85	°C
Storage Temperature Range ( $T_{STG}$ )	-55 to +125	°C
Temperature Coefficient ( $\alpha V$ ) of Clamping Voltage ( $V_C$ ) at Specified Test Current	<0.01	%/°C
Hi-Pot Encapsulation (COATING Isolation Voltage Capability)	2,500	V
Thermal Protection Isolation Voltage Capability (when operated)	600	V
COATING Insulation Resistance	1,000	MΩ
Indicator Lead Rating (Lead-3 - iTMOV® varistor only):		
Continuous RMS current	100	mA
Surge Current, 8/20µs	10,000	A

**CAUTION:** Stresses above those listed in "Absolute Maximum Ratings" may cause permanent damage to the device. This is a stress only rating and operation of the device at these or any other conditions above those indicated in the operational sections of this specification is not implied.

### TMOV® Ratings & Specifications

Lead-free and RoHS Compliant Models		Standard Models		Disc Dia-Meter	Maximum Rating (85°C)					Specifications (25 °C)				
					Continuous		Transient			Varistor Voltage at 1mA Test Current		Maximum Clamping Voltage 8/20µs		Typical Capacitance $f = 1\text{MHz}$
					AC Volts	Suppressed Voltage Rating	Energy 2ms	Peak Surge Current 8/20µs						
Part Number	Branding	Part Number	Branding	(mm)	$V_{M(A)C(R)M(S)}$ (V)	UL 1449 Table 60.1 (V)	$W_{TM}$ (J)	$I_{TM} 1 \times \text{Pulse}$ (A)	$I_{TM} 2 \times \text{Pulse}$ (A)	$V_{N(D)C} \text{ Min}$ (V)	$V_{N(D)C} \text{ Max}$ (V)	$V_C$ (V)	$I_{PK}$ (A)	C (pF)
TMOV14RP115E	P4T115E	TMOV14R115E	4T115E	14	115	300	35	6000	4500	162	198	300	50	1100
TMOV20RP115E	P2T115E	TMOV20R115E	20T115E	20	115	300	52	10000	6500	162	198	300	100	2400
TMOV14RP130E	P4T130E	TMOV14R130E	4T130E	14	130	400	50	6000	4500	184	226	340	50	1000
TMOV20RP130E	P2T130E	TMOV20R130E	20T130E	20	130	400	100	10000	6500	184	226	340	100	1900
TMOV14RP140E	P4T140E	TMOV14R140E	4T140E	14	140	500	55	6000	4500	200	240	360	50	900
TMOV20RP140E	P2T140E	TMOV20R140E	20T140E	20	140	400	110	10000	6500	200	240	360	100	1750
TMOV14RP150E	P4T150E	TMOV14R150E	4T150E	14	150	500	60	6000	4500	216	264	395	50	800
TMOV20RP150E	P2T150E	TMOV20R150E	20T150E	20	150	400	120	10000	6500	216	264	395	100	1600
TMOV14RP175E	P4T175E	TMOV14R175E	4T175E	14	175	700	70	6000	4500	243	297	455	50	700
TMOV20RP175E	P2T175E	TMOV20R175E	20T175E	20	175	700	135	10000	6500	243	297	455	100	1400
TMOV14RP200E	P4T200E	TMOV14R200E	4T200E	14	200	700	75	6000	4500	281	344	530	50	630
TMOV20RP200E	P2T200E	TMOV20R200E	20T200E	20	200	700	154	10000	6500	281	344	530	100	1250
TMOV14RP230E	P4T230E	TMOV14R230E	4T230E	14	230	700	80	6000	4500	324	396	595	50	550
TMOV20RP230E	P2T230E	TMOV20R230E	20T230E	20	230	700	160	10000	6500	324	396	595	100	1100
TMOV14RP250E	P4T250E	TMOV14R250E	4T250E	14	250	800	100	6000	4500	351	429	650	50	500
TMOV20RP250E	P2T250E	TMOV20R250E	20T250E	20	250	700	170	10000	6500	351	429	650	100	1000
TMOV14RP275E	P4T275E	TMOV14R275E	4T275E	14	275	900	110	6000	4500	387	473	710	50	450
TMOV20RP275E	P2T275E	TMOV20R275E	20T275E	20	275	700	190	10000	6500	387	473	710	100	900
TMOV14RP300E	P4T300E	TMOV14R300E	4T300E	14	300	900	125	6000	4500	423	517	775	50	400
TMOV20RP300E	P2T300E	TMOV20R300E	20T300E	20	300	900	250	10000	6500	423	517	775	100	800
TMOV14RP320E	P4T320E	TMOV14R320E	4T320E	14	320	900	136	6000	4500	459	561	840	50	380
TMOV20RP320E	P2T320E	TMOV20R320E	20T320E	20	320	900	372	10000	6500	459	561	840	100	750
TMOV14RP385E	P4T385E	TMOV14R385E	4T385E	14	385	1200	150	6000	4500	558	682	1025	50	360
TMOV20RP385E	P2T385E	TMOV20R385E	20T385E	20	385	1200	300	10000	6500	558	682	1025	100	700
TMOV14RP420E	P4T420E	TMOV14R420E	4T420E	14	420	1200	160	6000	4500	612	748	1120	50	300
TMOV20RP420E	P2T420E	TMOV20R420E	20T420E	20	420	1200	320	10000	6500	612	748	1120	100	600
TMOV20RP460E	P2T460E	TMOV20R460E	20T460E	20	460	n/a	360	10000	6500	675	825	1240	100	200



### TMOV® Ratings & Specifications (Continued...)

Lead-free and RoHS Compliant Models		Standard Models		Disc Diameter	Maximum Rating (85°C)					Specifications (25°C)				
					Continuous	Transient			Varistor Voltage at 1mA Test Current	Maximum Clamping Voltage 8/20µs	Typical Capacitance f = 1MHz			
Part Number	Branding	Part Number	Branding	V <sub>MIA/CIRMS</sub>	UL 1449 Table 60.1	W <sub>TM</sub>	I <sub>TM</sub> 1 x Pulse	I <sub>TM</sub> 2 x Pulse				V <sub>N(DC)</sub> Min	V <sub>N(DC)</sub> Max	V <sub>C</sub>
									(mm)	(V)	(V)			
TMOV20RP510E	P2T510E	TMOV20R510E	20T510E	20	510	n/a	325	10000	6500	738	902	1355	100	350
TMOV20RP550E	P2T550E	TMOV20R550E	20T550E	20	550	n/a	360	10000	6500	819	1001	1500	100	300
TMOV20RP575E	P2T575E	TMOV20R575E	20T575E	20	575	n/a	375	10000	6500	856	1047	1568	100	275
TMOV20RP625E	P2T625E	TMOV20R625E	20T625E	20	625	n/a	400	10000	6500	900	1100	1650	100	250
TMOV20RP750E	P2T750E	TMOV20R750E	20T750E	20	750	n/a	480	10000	6500	1080	1320	1980	100	175

NOTE: For 14mm devices with a voltage rating greater than 420V, please contact factory regarding availability.

### iTMOV® Ratings & Specifications

Lead-free And RoHS Compliant Models		Standard Models		Disc Diameter	Maximum Rating (85°C)					Specifications (25°C)				
					Continuous	Transient			Varistor Voltage at 1mA Test Current	Maximum Clamping Voltage 8/20µs	Typical Capacitance f = 1MHz			
Part Number	Branding	Part Number	Branding	V <sub>MIA/CIRMS</sub>	UL 1449 Table 60.1	W <sub>TM</sub>	I <sub>TM</sub> 1 x Pulse	I <sub>TM</sub> 2 x Pulse				V <sub>N(DC)</sub> Min	V <sub>N(DC)</sub> Max	V <sub>C</sub>
									(mm)	(V)	(V)			
TMOV14RP115M	P4T115M	TMOV14R115M	4T115M	14	115	300	35	6000	4500	162	198	300	50	1100
TMOV20RP115M	P2T115M	TMOV20R115M	20T115M	20	115	300	52	10000	6500	162	198	300	100	2400
TMOV14RP130M	P4T130M	TMOV14R130M	4T130M	14	130	400	50	6000	4500	184	226	340	50	1000
TMOV20RP130M	P2T130M	TMOV20R130M	20T130M	20	130	400	100	10000	6500	184	226	340	100	1900
TMOV14RP140M	P4T140M	TMOV14R140M	4T140M	14	140	500	55	6000	4500	200	240	360	50	900
TMOV20RP140M	P2T140M	TMOV20R140M	20T140M	20	140	400	110	10000	6500	200	240	360	100	1750
TMOV14RP150M	P4T150M	TMOV14R150M	4T150M	14	150	500	60	6000	4500	216	264	395	50	800
TMOV20RP150M	P2T150M	TMOV20R150M	20T150M	20	150	400	120	10000	6500	216	264	395	100	1600
TMOV14RP175M	P4T175M	TMOV14R175M	4T175M	14	175	700	70	6000	4500	243	297	455	50	700
TMOV20RP175M	P2T175M	TMOV20R175M	20T175M	20	175	700	135	10000	6500	243	297	455	100	1400
TMOV14RP200M	P4T200M	TMOV14R200M	4T200M	14	200	700	75	6000	4500	281	344	530	50	630
TMOV20RP200M	P2T200M	TMOV20R200M	20T200M	20	200	700	154	10000	6500	281	344	530	100	1250
TMOV14RP230M	P4T230M	TMOV14R230M	4T230M	14	230	700	80	6000	4500	324	396	595	50	550
TMOV20RP230M	P2T230M	TMOV20R230M	20T230M	20	230	700	160	10000	6500	324	396	595	100	1100
TMOV14RP250M	P4T250M	TMOV14R250M	4T250M	14	250	800	100	6000	4500	351	429	650	50	500
TMOV20RP250M	P2T250M	TMOV20R250M	20T250M	20	250	700	170	10000	6500	351	429	650	100	1000
TMOV14RP275M	P4T275M	TMOV14R275M	4T275M	14	275	900	110	6000	4500	387	473	710	50	450
TMOV20RP275M	P2T275M	TMOV20R275M	20T275M	20	275	700	190	10000	6500	387	473	710	100	900
TMOV14RP300M	P4T300M	TMOV14R300M	4T300M	14	300	900	125	6000	4500	423	517	775	50	400
TMOV20RP300M	P2T300M	TMOV20R300M	20T300M	20	300	900	250	10000	6500	423	517	775	100	800
TMOV14RP320M	P4T320M	TMOV14R320M	4T320M	14	320	900	136	6000	4500	459	561	840	50	380
TMOV20RP320M	P2T320M	TMOV20R320M	20T320M	20	320	900	372	10000	6500	459	561	840	100	750
TMOV14RP385M	P4T385M	TMOV14R385M	4T385M	14	385	1200	150	6000	4500	558	682	1025	50	360
TMOV20RP385M	P2T385M	TMOV20R385M	20T385M	20	385	1200	300	10000	6500	558	682	1025	100	700
TMOV14RP420M	P4T420M	TMOV14R420M	4T420M	14	420	1200	160	6000	4500	612	748	1120	50	300
TMOV20RP420M	P2T420M	TMOV20R420M	20T420M	20	420	1200	320	10000	6500	612	748	1120	100	600
TMOV20RP460M	P2T460M	TMOV20R460M	20T460M	20	460	n/a	360	10000	6500	675	825	1240	100	200
TMOV20RP510M	P2T510M	TMOV20R510M	20T510M	20	510	n/a	325	10000	6500	738	902	1355	100	350
TMOV20RP550M	P2T550M	TMOV20R550M	20T550M	20	550	n/a	360	10000	6500	819	1001	1500	100	300
TMOV20RP575M	P2T575M	TMOV20R575M	20T575M	20	575	n/a	375	10000	6500	856	1047	1568	100	275
TMOV20RP625M	P2T625M	TMOV20R625M	20T625M	20	625	n/a	400	10000	6500	900	1100	1650	100	250
TMOV20RP750M	P2T750M	TMOV20R750M	20T750M	20	750	n/a	480	10000	6500	1080	1320	1980	100	175

NOTE: For 14mm devices with a voltage rating greater than 420V, please contact factory regarding availability.



### Thermal Characteristics

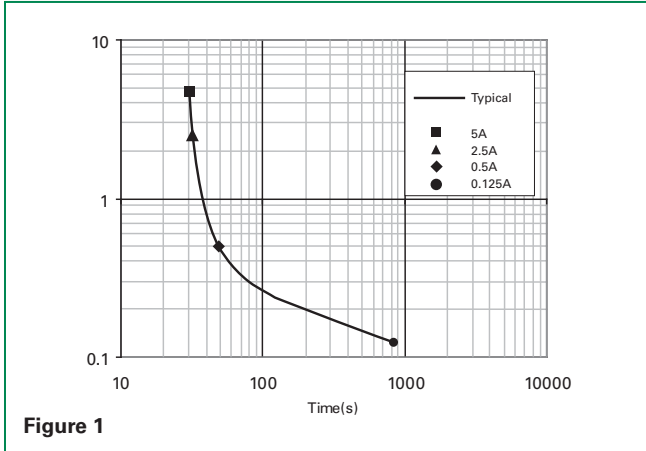


Figure 1

Note : The TMOV® and iTMOV® varistors are intended, in conjunction with appropriate enclosure design, to help facilitate TVSS module compliance to UL 1449, 2nd Edition Section 37.4 (abnormal overvoltage limited current requirements). Under these extreme abnormal overvoltage conditions, some units will exhibit substantial heating, arcing and venting prior to opening. Modules should be designed to contain this possibility. Application testing is strongly recommended.

### Current, Energy, Power Derating Curve

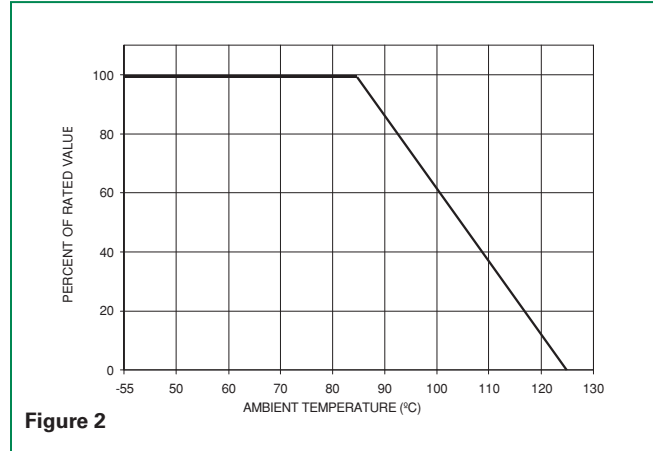


Figure 2

For applications exceeding 85°C ambient temperature, the peak surge current and energy ratings must be reduced as shown above.

### Maximum Clamping Voltage for 14mm Parts

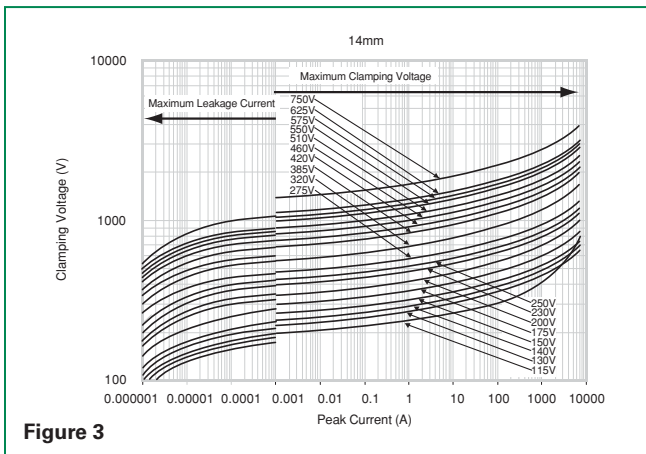


Figure 3

### Maximum Clamping Voltage for 20mm Parts

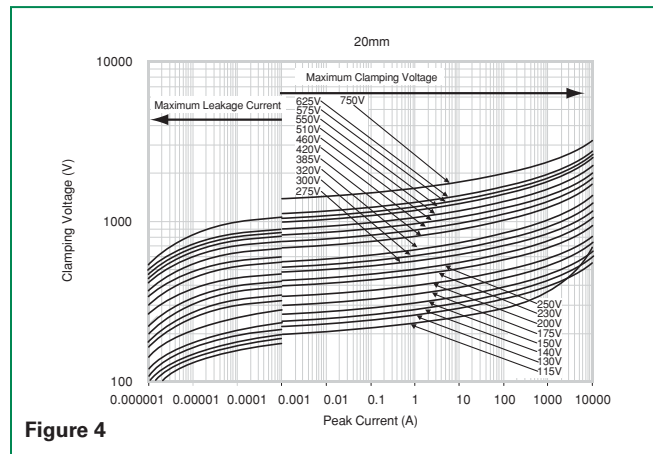
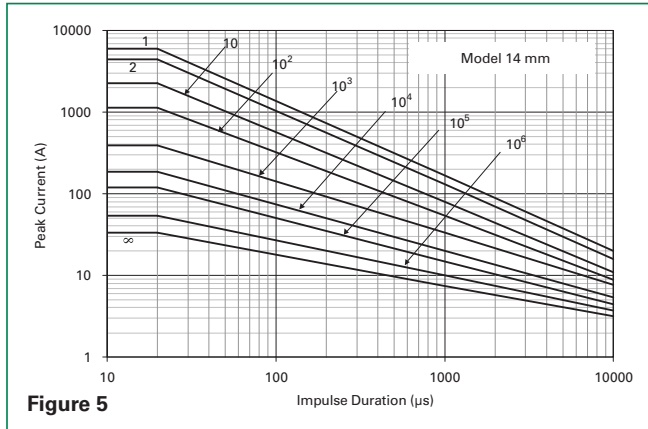


Figure 4

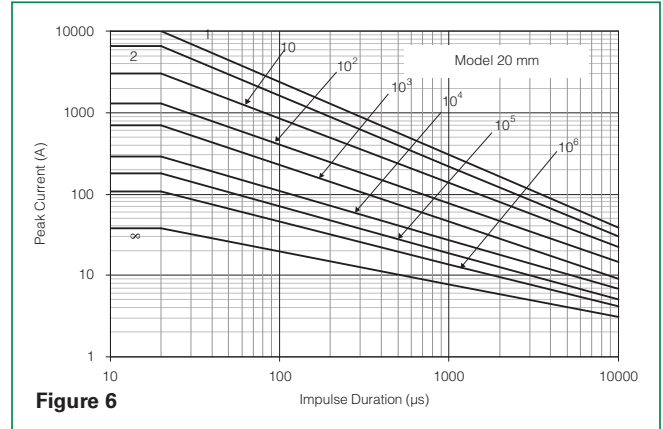
**Repetitive Surge Capability for 14mm Parts**



**Figure 5**

NOTE: Average power dissipation of transients should not exceed 0.6W

**Repetitive Surge Capability for 20mm Parts**



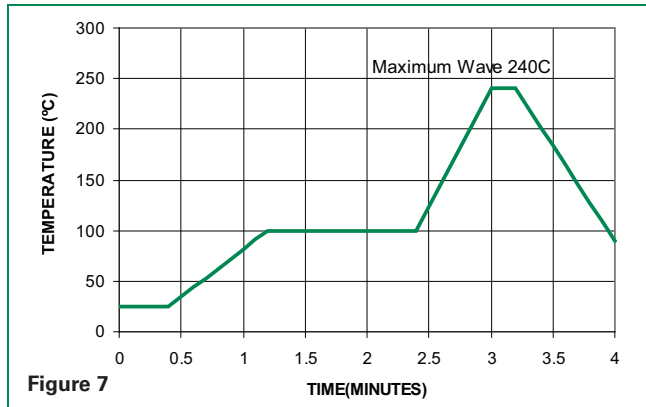
**Figure 6**

NOTE: Average power dissipation of transients should not exceed 1.0W

**Wave Solder Profile**

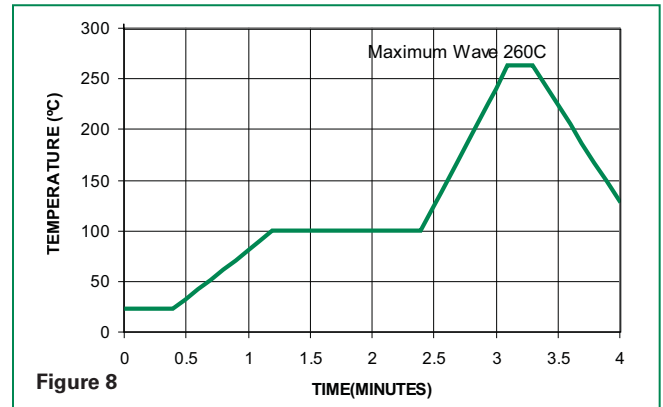
Because the TMOV® and iTMOV® varistors contain a thermal protection device, care must be taken when soldering the devices into place. Two soldering methods are possible. Firstly, hand soldering: It is recommended to heat-sink the leads of the device. Secondly, wave soldering: It is critically important that all preheat stage and the solder bath temperatures are rigidly controlled.

**Non Lead-free Profile**



**Figure 7**

**Lead-free Profile**



**Figure 8**

**Physical Specifications**

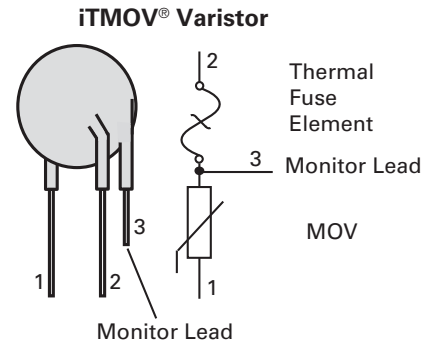
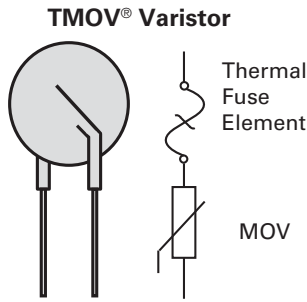
<b>Lead Material</b>	Non Lead-free parts: Solder coated Copper wire, or Tin-coated Copper wire Lead-free parts: Tin-coated Copper wire
<b>Soldering Characteristics</b>	Solderability per MIL-STD-202, Method 208E
<b>Insulating Material</b>	Cured, flame retardant epoxy polymer meets UL94V-0 requirements
<b>Device Labeling</b>	Marked with LF, voltage, UL/CSA logos, and date code

**Environmental Specifications**

<b>Operating/Storage Temperature</b>	-40°C to +85°C
<b>Passive Aging</b>	+85°C, 1000 hours +/-10% typical voltage change
<b>Humidity Aging</b>	+85°C, 85% RH, 1000 hours +/-10% typical voltage change
<b>Thermal Shock</b>	+85°C to -40°C 5 times +/-10% typical voltage change
<b>Solvent Resistance</b>	MIL-STD-202, Method 215F
<b>Moisture Sensitivity</b>	Level 1, J-STD-020C

TMOV®/iTMOV® Series

### Lead Configurations



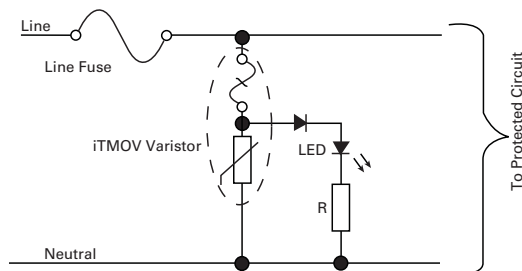
Note: MOVs are non-polarized passive elements

### iTMOV® Varistor Application Examples

The application examples below show how the indicator lead on the iTMOV® can be used to indicate that the thermal element has been opened. This signifies that the circuit is no longer protected from transients by the MOV.

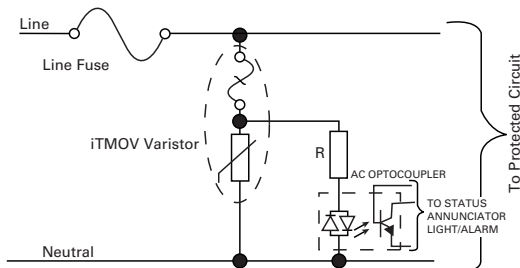
#### Application Example 1

In this case, the LED is normally on, and is off when the thermal element opens.



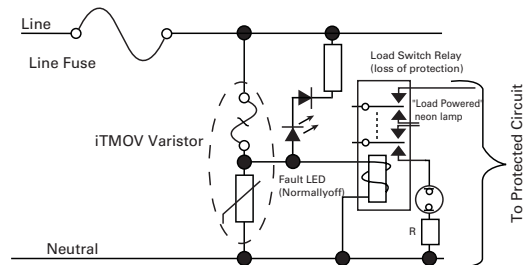
#### Application Example 2

This circuit utilizes an optocoupler to provide galvanic isolations between the iTMOV® varistor and the indicating or alarm circuitry.



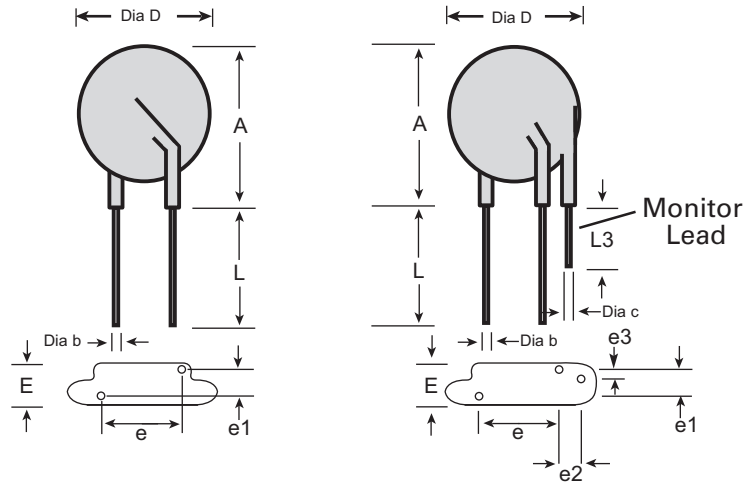
#### Application Example 3

This circuit illustrates the use of the monitoring lead of the iTMOV® varistor to ensure that equipment is only operated when overvoltage protection is present. In normal operation the load switch relay solenoid is powered via the indicator lead of the iTMOV® varistor. In the event of the thermal element being activated, the relay will de-activate, cutting power to the protected circuit and the fault LED will illuminate.



Please note: Indicator circuits are provided as a guideline only. Verification of actual indicator circuitry is the responsibility of the end user. Component values selected must be appropriate for the specific AC line voltage service and application.

**Dimensions**



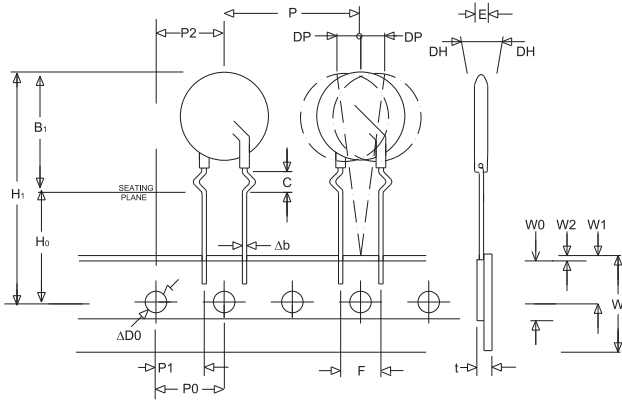
Dimension	V <sub>RMS</sub> Voltage Model	TMOV® Varistor				iTMOV® Varistor			
		14mm Size		20mm Size		14mm Size		20mm Size	
		Min. mm (in)	Max. mm (in)	Min. mm (in)	Max. mm (in)	Min. mm (in)	Max. mm (in)	Min. mm (in)	Max. mm (in)
<b>A</b>	ALL	17.0 (0.669)	22.0 (0.866)	23.0 (0.906)	28.0 (1.10)	17.0 (0.669)	22.0 (0.866)	23.0 (0.906)	28.0 (1.10)
<b>Dia D</b>	ALL	13.5 (0.531)	17.0 (0.669)	19.0 (0.748)	23.0 (0.906)	13.5 (0.531)	17.0 (0.669)	19.0 (0.748)	23.0 (0.906)
<b>e</b>	ALL	6.5 (0.256)	8.5 (0.335)	6.5 (0.256)	8.5 (0.335)	6.5 (0.256)	8.5 (0.335)	6.5 (0.256)	8.5 (0.335)
<b>e1</b>	115-175	1.5 (0.059)	4.0 (0.157)	1.5 (0.059)	4.0 (0.157)	1.5 (0.059)	4.0 (0.157)	1.5 (0.059)	4.0 (0.157)
	200-420	2.0 (0.079)	6.0 (0.236)	2.0 (0.079)	6.0 (0.236)	2.0 (0.079)	6.0 (0.236)	2.0 (0.079)	6.0 (0.236)
	460-750	n/a	n/a	0	2.0 (0.079)	n/a	n/a	0	2.0 (0.079)
<b>e2</b>	ALL	n/a	n/a	n/a	n/a	4.0 (0.138)	6.0 (0.236)	4.0 (0.157)	6.0 (0.236)
<b>e3</b>	ALL	n/a	n/a	n/a	n/a	0	2.0 (0.079)	0	2.0 (0.079)
<b>E</b>	115-175	--	9.0 (0.335)	--	9.0 (0.335)	--	9.0 (0.335)	--	9.0 (0.335)
	200-275	--	9.5 (0.374)	--	9.5 (0.374)	--	9.5 (0.374)	--	9.5 (0.374)
	300-460	--	11.0 (0.433)	--	11.0 (0.433)	--	11.0 (0.433)	--	11.0 (0.433)
	510-575	--	n/a	--	12.0 (0.472)	--	n/a	--	12.0 (0.472)
	625-750	--	n/a	--	13.0 (0.512)	--	n/a	--	13.0 (0.512)
<b>L</b>	ALL	25.4 (1.00)	--	25.4 (1.00)	--	25.4 (1.00)	--	25.4 (1.00)	--
<b>L3</b>	ALL	n/a	n/a	n/a	n/a	6.0 (0.236)	--	6.0 (0.236)	--
<b>Dia b</b>	115-420	0.76 (0.030)	0.86 (0.034)	0.76 (0.030)	0.86 (0.034)	0.76 (0.030)	0.86 (0.034)	0.76 (0.030)	0.86 (0.034)
	460-750	n/a	n/a	0.95 (0.037)	1.05 (0.041)	n/a	n/a	0.95 (0.037)	1.05 (0.041)
<b>Dia c</b> Outside Lead Only	ALL	n/a	n/a	n/a	n/a	0.76 (0.030)	0.86 (0.034)	0.76 (0.030)	0.86 (0.034)

For 14mm ratings above 420 V<sub>RMS</sub> contact factory for specifications.

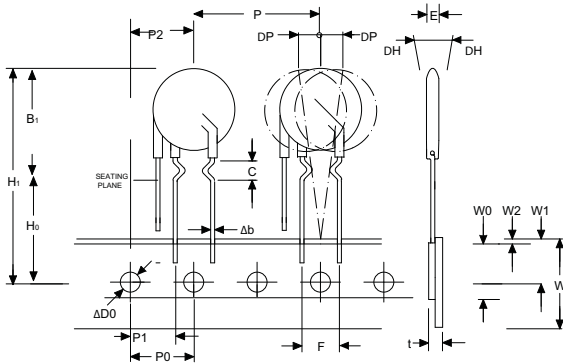
TMOV®/iTMOV® Series

### Tape and Reel Specification

TMOV® VARISTOR WITH OUTER CRIMP



iTMOV® VARISTOR WITH INNER CRIMP



- Reel capacity varies with voltage.
- Leads are crimped and in-line. This excludes the monitor lead on iTMOV® devices which are not crimped and not in-line.
- To order tape and reel option please add suffix 'L2T7' to end of standard part number.
- Tape and reel option is available for rated voltages up to 420V. Contact factory regarding availability of higher voltages.

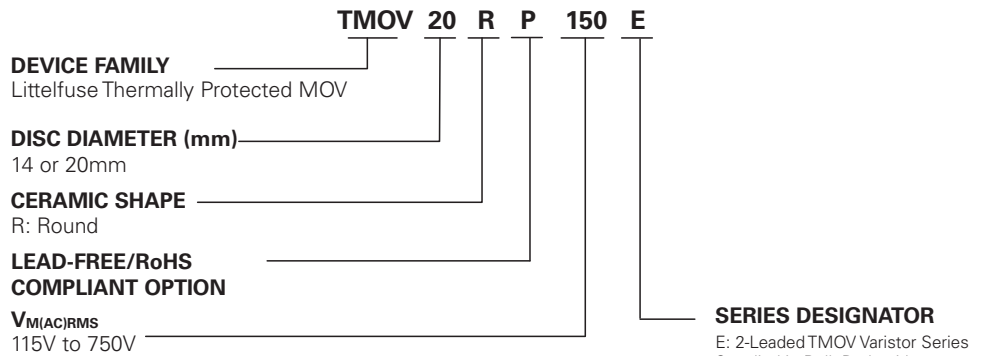
Contact Littelfuse for additional details.

	DESCRIPTION	MODEL SIZE	
		14mm	20mm
<b>B<sub>1</sub></b>	Component Top to Seating Plane	22.5 Max	31 Max
<b>P</b>	Pitch of Component	25.4 +/- 1.0	25.4 +/- 1.0
<b>P<sub>0</sub></b>	Feed Hole Pitch	12.7 +/- 0.2	12.7 +/- 0.2
<b>P<sub>1</sub></b>	Feed Hole Center to Pitch	8.95 +/- 0.7	8.95 +/- 0.7
<b>P<sub>2</sub></b>	Hole Center to Component Center	12.7 +/- 0.7	12.7 +/- 0.7
<b>F</b>	Lead to Lead Distance	7.5 +/- 0.8	7.5 +/- 0.8
<b>Δh</b>	Component Alignment	2.0 Max	2.0 Max
<b>W</b>	Tape Width	18.0 +1.0/-0.5	18.0 +1.0/-0.5
<b>W<sub>0</sub></b>	Hold Down Tape Width	12.0 +/- 0.3	12.0 +/- 0.3
<b>W<sub>1</sub></b>	Hole Position	9.0 +0.75/-0.50	9.0 +0.75/-0.50
<b>W<sub>2</sub></b>	Hold Down Tape Position	0.5 Max	0.5 Max
<b>H<sub>1</sub></b>	Component Height	40.0 Max	46.5 Max
<b>D<sub>0</sub></b>	Feed Hole Diameter	4.0 +/- 0.2	4.0 +/- 0.2
<b>t</b>	Total Tape Thickness	0.7 +/- 0.2	0.7 +/- 0.2
<b>L</b>	Length of Clipped Lead	11.0 Max	11.0 Max
<b>Δp</b>	Component Alignment	3 Max. 1.00mm	3 Max
<b>C</b>	Crimp Length	2.6 typ	2.6 typ
<b>H<sub>0</sub></b>	Seating Plane Height	16.0 +/- 0.5	16.0 +/- 0.5

Dimensions in mm

**Part Numbering System**

**Standard Parts**



NOTE: By ordering the standard part number, i.e. TMOV20R150E or TMOV20RP150E, standard straight lead styles, standard bulk packing and standard lead spacing will be supplied. These specifications are as follows:

- Straight Leads
- Bulk Packed
- 7.5mm Lead Spacing
- Leads not in-line except parts > 420 V

(Available in 20mm only)

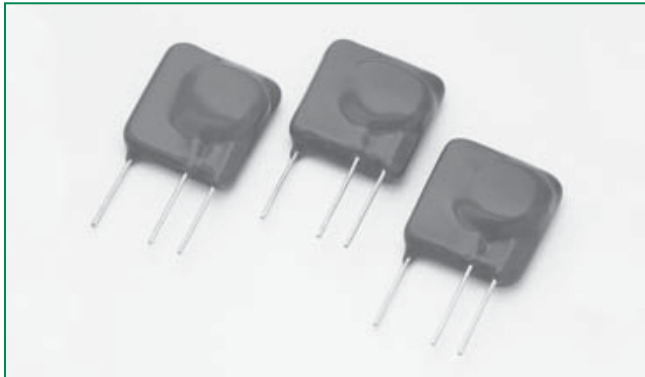
**Pack Quantities**

Rated Voltage	Pack Quantities			
	Bulk Pack		Tape and Reel	
	Model Size		Model Size	
	14mm	20mm	14mm	20mm
115-250	600	400	500	400
275-550	500	300	400	300
575-750	400	200	n/a	n/a

NOTE: Tape and Reel available up to 420V only - please contact factory regarding availability of higher voltage parts.







### Description


Metal Oxide Varistors (MOVs) are rated for specific AC line operating voltages. Exceeding these limits through the application of a sustained abnormal over-voltage condition could result in overheating and damage to the MOV. This condition is specifically identified and addressed in the UL 1449 TVSS Standard – called Limited Current Abnormal Overvoltage test.

The Littelfuse TMOV25S™ (Thermal MOV) Series addresses this test condition in a single integrated package. The TMOV® Series is based on the Littelfuse UltraMOV™ Series which meets the surge suppressor component recognition requirements of UL 1449 for both cord connected and permanently connected TVSS end products. Additionally, the TMOV® Varistor incorporates a patented integrated thermally responsive element within the body of the device which will open-circuit the varistor in case of overheating due to the abnormal over-voltages per UL 1449 requirements–Note 1.

The TMOV® Series is designed to meet the Abnormal Over-voltage requirements of UL 1449 (Abnormal Over-voltage Limited Current requirements up to and including the 10A/7hrs requirement).

The TMOV® Varistor can be wave soldered without any need for special or expensive assembly processes.

### Agency Approvals

Agency	Agency File Number	Status
	UL1449 <sup>4</sup> “Ed. 3	Pending

- Under UL1449 limited current testing parts rated >420V will not open due to 600V voltage limit. Devices with ratings >420V have not yet been evaluated.
- Regarding thermal cut-offs for ratings up to 420VAC.

CAUTION: Stresses above those listed in “Absolute Maximum Ratings” may cause permanent damage to the device. This is a stress only rating and operation of the device at these or other conditions above those indicated in the operational sections of this specification is not implied.

### Applications

- TVSS Products
- AC Panel Protection Modules
- AC Line Power Supplies
- Surge Protected Strip Connectors
- AC Power Meters
- Inverters, AC/DC power supplies, etc.
- UPS (Uninterruptible Power Supply)

### Features

- RoHS Compliant and Lead-free
- Patented integrated thermal protection device - Patent #US6636403
- Designed to facilitate compliance to UL1449 3rd Edition for TVSS product
- Standard Operating Voltage Range Compatible with Common AC Line Voltages (115VAC to 750VAC)
- Wave solderable
- High peak surge current rating up to 20kA at single 8/20µS impulse
- Meets UL 1449 Abnormal Over-voltage test (Conforms to limited current testing at 0.5A, 2.5A, 5A and 10A)
- Standard lead form and spacing option
- Low leakage
- -55°C to +85°C operating temperature range

### Absolute Maximum Ratings

• For ratings of individual members of a series, see Device Ratings and Specifications chart.

	TMOV25S™ Series	Units
<b>Continuous:</b>		
AC Voltage Range ( $V_{M(A)C(R)M(S)}$ )	115 to 750	V
<b>Transient:</b>		
<b>Peak Pulse Current (<math>I_{TM}</math>)</b>		
For 8x20µs Current Wave, single pulse	20,000	A
<b>Single-Pulse Energy Capability</b>		
For 2ms Current Wave	170 to 670	J
Operating Ambient Temperature Range ( $T_A$ )	-55 to +85	°C
Storage Temperature Range ( $T_{STG}$ )	-55 to +125	°C
Temperature Coefficient ( $\alpha_V$ ) of Clamping Voltage ( $V_C$ ) at Specified Test Current	<0.01	%/°C
Hi-Pot Encapsulation (COATING Isolation Voltage Capability)	2,500	V
Under UL 1449 Limited Current Test Procedure-see NOTE#1	600	V
COATING Insulation Resistance	1,000	MΩ

Note#1 - Under UL1449 limited current testing parts rated >420V will not open due to 600V voltage limit. Devices with ratings >420V have not yet been evaluated.

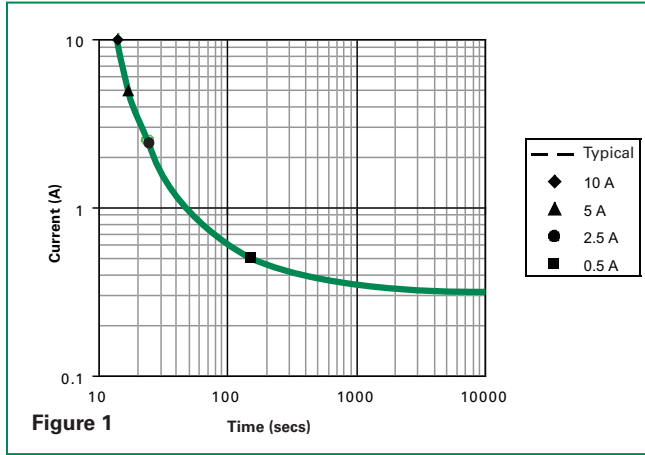
CAUTION: Stresses above those listed in "Absolute Maximum Ratings" may cause permanent damage to the device. This is a stress only rating and operation of the device at these or any other conditions above those indicated in the operational sections of this specification is not implied.

### Device Ratings & Specifications

Part Number		Maximum Rating (85°C)			Specifications (25 °C)					
		Continuous		Transient	Varistor Voltage at 1mA Test Current		Clamping Voltage at 100A Current 8/20µs	UL 1449 3 <sup>rd</sup> Edition	Nominal Discharge Current	Typical Capacitance
		AC Volts	Energy 2ms	Peak Current 8/20µs						
Part Number	Branding	$V_{M(A)C(R)M(S)} / MCOV$	$W_{TM}$	$I_{TM} \times 1 \times \text{Pulse}$	$V_{N(DC)} \text{ Min}$	$V_{N(DC)} \text{ Max}$	$V_C$	VPR <sup>2</sup>	$I_N$	C
		(V)	(J)	(A)	(V)		(V)	(V)	(A)	(pF)
TMOV25SP115M	P25T115M	115	170	20000	162	198	295	400	5800	3200
TMOV25SP130M	P25T130M	130	190	20000	184	226	335	500	5800	2800
TMOV25SP140M	P25T140M	140	210	20000	200	240	355	500	5800	2500
TMOV25SP150M	P25T150M	150	220	20000	216	264	390	500	5800	2300
TMOV25SP175M	P25T175M	175	250	20000	243	297	450	600	5800	1900
TMOV25SP230M	P25T230M	230	300	20000	324	396	585	700	5800	1500
TMOV25SP250M	P25T250M	250	330	20000	351	429	640	800	5800	1400
TMOV25SP275M	P25T275M	275	350	20000	387	473	700	900	5800	1250
TMOV25SP300M	P25T300M	300	370	20000	423	517	765	1000	5800	1150
TMOV25SP320M	P25T320M	320	390	20000	459	561	825	1000	5800	1080
TMOV25SP385M	P25T385M	385	430	20000	558	682	1010	1200	5800	900
TMOV25SP420M1	P25T420M	420	460	20000	612	748	1100	1500	5800	820
TMOV25SP440M1	P25T440M	440	470	20000	643	787	1160	n/a	5800	790
TMOV25SP460M1	P25T460M	460	490	20000	675	825	1220	n/a	5800	750
TMOV25SP510M1	P25T510M	510	520	20000	738	902	1335	n/a	5800	680
TMOV25SP550M1	P25T550M	550	550	20000	819	1001	1475	n/a	5800	630
TMOV25SP625M1	P25T625M	625	600	20000	900	1100	1625	n/a	5800	550
TMOV25SP750M1	P25T750M	750	670	20000	1080	1320	1950	n/a	5800	460

**Thermal Characteristics**

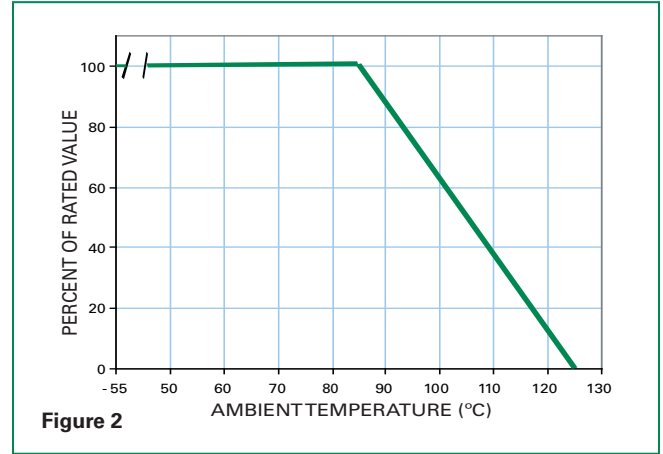
Typical time to open circuit under UL 1449 Abnormal Overvoltage Limited Current Test:



**Figure 1**

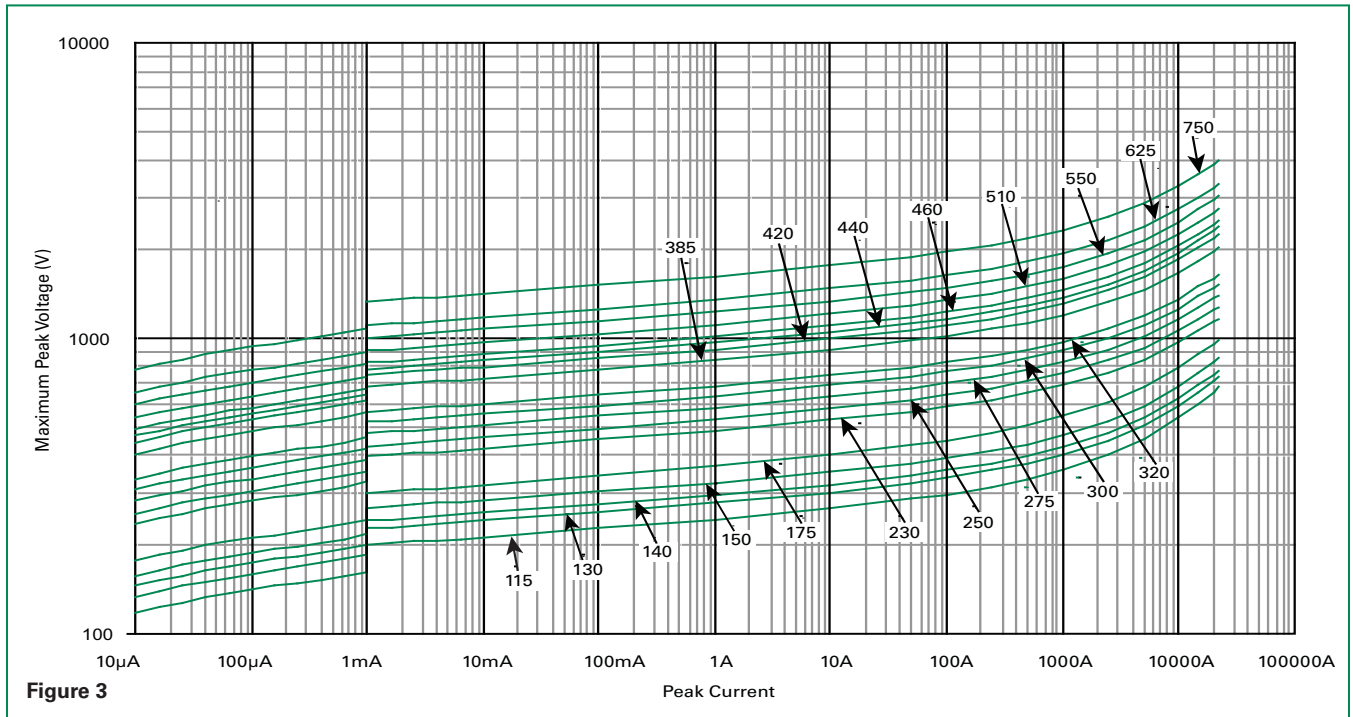
**Current, Energy, Power Derating Curve**

For applications exceeding 85°C ambient temperature, the peak surge current and energy ratings must be reduced as shown below.



**Figure 2**

**Transient V-I Characteristic Curves**



**Figure 3**

TMOV25S™ Series

**Pulse Rating Curve**

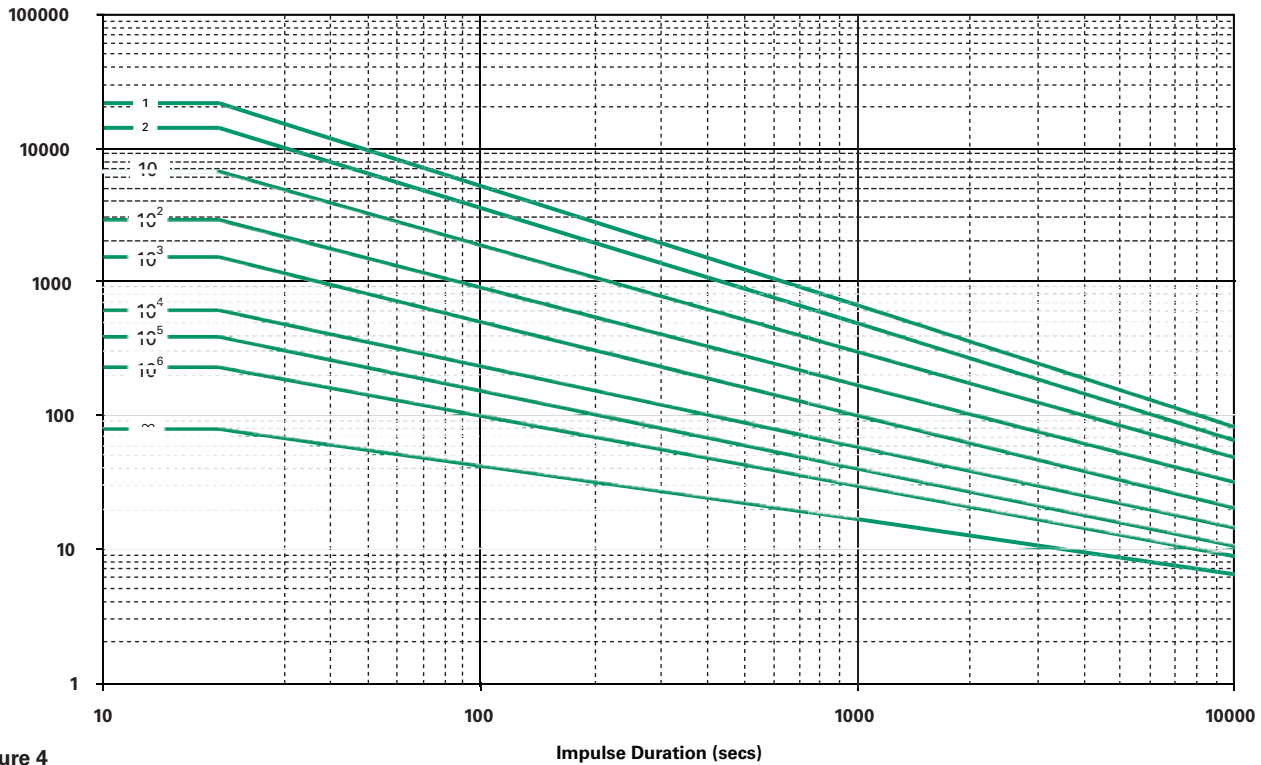


Figure 4

**Wave Solder Profile**

Because the TMOV25S™ Series contains a thermally responsive device, care must be taken when soldering the device into place. Two soldering methods are possible. Firstly, hand soldering: We recommend the use of pliers to heat-sink the leads of the device. Secondly, wave-soldering: This is a strenuous process requiring pre-heat stages to reduce the stresses on devices.

It is critically important that all preheat stage and the solder bath temperatures are rigidly controlled. The recommended solder for the TMOV® Series is a 62/36/2 (Sn/Pb/Ag), 60/40 (Sn/Pb) or 63/37 (Sn/Pb). Littelfuse also recommends an RMA solder flux. SAC solders (SnAgCu) are recommended for Lead-free applications.

**Soldering Profile**

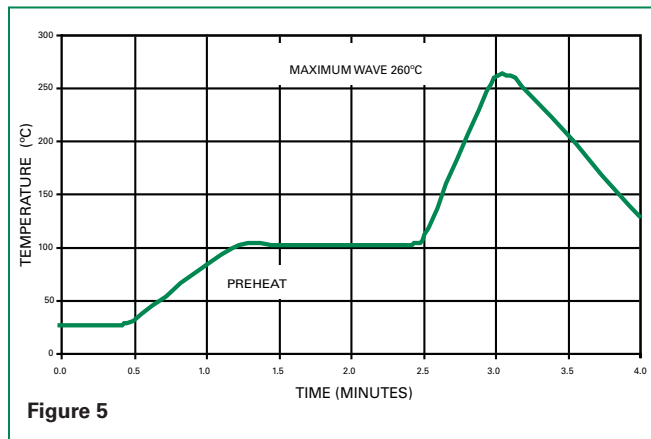


Figure 5

**Physical Specifications**

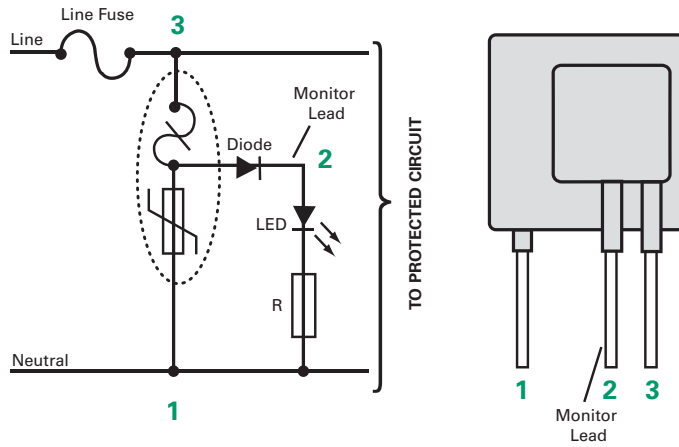
<b>Lead Material</b>	Tin-coated Copper wire
<b>Soldering Characteristics</b>	Solderability per MIL-STD-202, Method 208E
<b>Insulating Material</b>	Cured, flame retardant epoxy polymer meets UL94V-0 requirements
<b>Device Labeling</b>	Marked with LF, voltage, UL logos, and date code

**Environmental Specifications**

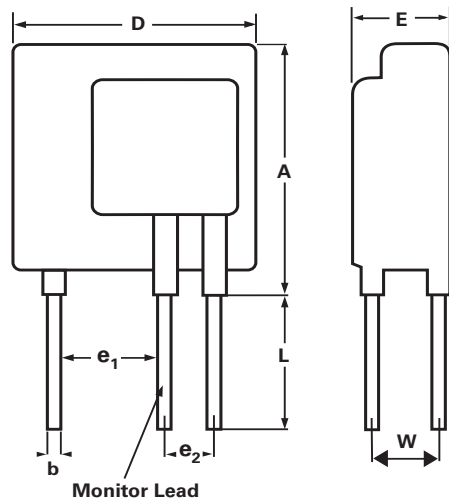
<b>Operating/Storage Temperature</b>	-40°C to +85°C
<b>Passive Aging</b>	+85°C, 1000 hours -/+10% typical voltage change
<b>Humidity Aging</b>	+85°C, 85%R.H., 1000 hours -/+10% typical voltage change
<b>Thermal Shock</b>	+85°C to -40°C 5 times -/+10% typical voltage change
<b>Solvent Resistance</b>	MIL-STD-202, Method 215F
<b>Moisture Sensitivity</b>	Level 1, J-STD-020C

**Application Example**

The application example left shows how the indicator lead on the TMOV® can be used to indicate that thermal element has been opened. This signifies that the circuit is no longer protected from transients by the MOV.



### Dimensions

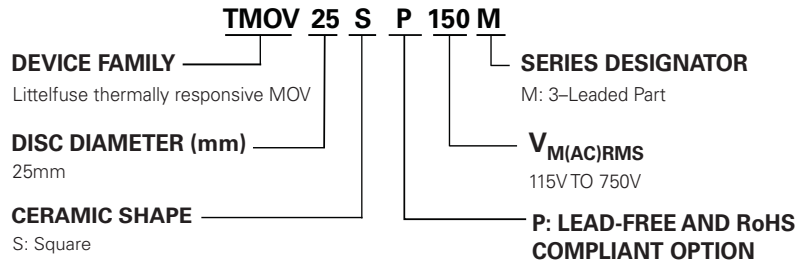


### Product Dimensions (mm)

Part Number	$A_{MAX}$	$B_{MIN}$	$B_{MAX}$	$D_{MAX}$	$e_1$	$e_2$	L	$W_{MIN}$	$W_{MAX}$	E
TMOV25SP115M	32.5	0.95	1.05	28	12.7+/-1	6.5+/-1	12.7 Min.	1.5	2.7	11.7
TMOV25SP130M	32.5	0.95	1.05	28	12.7+/-1	6.5+/-1	12.7 Min.	1.6	2.9	11.9
TMOV25SP140M	32.5	0.95	1.05	28	12.7+/-1	6.5+/-1	12.7 Min.	1.7	3.0	12.0
TMOV25SP150M	32.5	0.95	1.05	28	12.7+/-1	6.5+/-1	12.7 Min.	1.8	3.1	12.1
TMOV25SP175M	32.5	0.95	1.05	28	12.7+/-1	6.5+/-1	12.7 Min.	1.9	3.3	12.3
TMOV25SP230M	32.5	0.95	1.05	28	12.7+/-1	6.5+/-1	12.7 Min.	2.0	3.4	12.4
TMOV25SP250M	32.5	0.95	1.05	28	12.7+/-1	6.5+/-1	12.7 Min.	2.1	3.5	12.5
TMOV25SP275M	32.5	0.95	1.05	28	12.7+/-1	6.5+/-1	12.7 Min.	2.3	3.7	12.7
TMOV25SP300M	32.5	0.95	1.05	28	12.7+/-1	6.5+/-1	12.7 Min.	2.4	3.9	12.9
TMOV25SP320M	32.5	0.95	1.05	28	12.7+/-1	6.5+/-1	12.7 Min.	2.6	4.1	13.1
TMOV25SP385M	32.5	0.95	1.05	28	12.7+/-1	6.5+/-1	12.7 Min.	3.0	4.7	13.7
TMOV25SP420M	32.5	0.95	1.05	28	12.7+/-1	6.5+/-1	12.7 Min.	3.3	5.0	14.0
TMOV25SP440M	32.5	0.95	1.05	28	12.7+/-1	6.5+/-1	12.7 Min.	3.4	5.2	14.2
TMOV25SP460M	32.5	0.95	1.05	28	12.7+/-1	6.5+/-1	12.7 Min.	3.6	5.4	14.4
TMOV25SP510M	32.5	0.95	1.05	28	12.7+/-1	6.5+/-1	12.7 Min.	3.9	5.7	14.7
TMOV25SP550M	32.5	0.95	1.05	28	12.7+/-1	6.5+/-1	12.7 Min.	4.2	6.2	15.2
TMOV25SP625M	32.5	0.95	1.05	28	12.7+/-1	6.5+/-1	12.7 Min.	4.6	6.6	15.6
TMOV25SP750M	32.5	0.95	1.05	28	12.7+/-1	6.5+/-1	12.7 Min.	5.4	7.7	16.7

For 14mm ratings above 420 V<sub>RMS</sub> contact factory for specifications.

**Part Numbering System**



**Term Definitions**

**Rated AC Voltage (V<sub>M(AC)RMS</sub>) – MCOV**

This is the maximum continuous sinusoidal RMS voltage that may be applied. This voltage may be applied at any temperature up to the maximum operating temperature of the device.

**Maximum Non-Repetitive Surge Current (I<sub>TM</sub>)**

This is the maximum peak current which may be applied for a single 8/20µs impulse, with rated line voltage also applied, without causing device failure. The pulse can be applied to the device in either polarity with the same confidence factor.

**Nominal Discharge Current (I<sub>N</sub>)**

Peak value of the current, selected by the manufacturer, through the SPD having a current waveshape of 8/20µs where the SPD remains functional after 15 surges.

**Voltage Protection Rating (V<sub>PR</sub>)**

A rating selected from a list of preferred values as given in UL 1449 and assigned to each mode of protection. The value of VPR is determined as the nearest highest value taken from UL 1449 to the measured limiting voltage determined during the transient-voltage surge suppression test using the combination wave generator at a setting of 6kV, 3kA.

**UL 1449**

An Underwriters Laboratory standard covering the safety requirements for Surge Protective Devices intended for permanently connected, cord-connected and direct plug-in applications.

**Limited Current Abnormal Over-voltage Test**

An AC over-voltage condition applied to a Surge Protective Device according to UL 1449, Section 39.4. The short circuit current is limited by series connected resistors to 10A, 5A, 2.5A, 0.5A and 0.125A. The condition is maintained for 7 hours or until the device under test is disconnected from the AC supply or the current or temperature reaches equilibrium.

**Maximum Non-Repetitive Surge Energy (W<sub>TM</sub>)**

This is the maximum rated transient energy which may be dissipated for a single current pulse at a specified impulse duration, with the rated RMS voltage applied, without causing device failure.

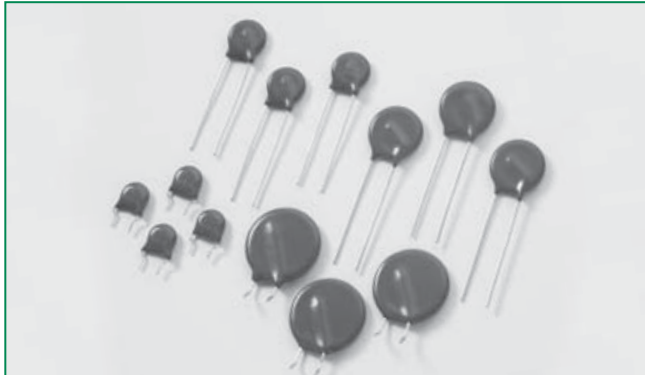
**Nominal Voltage (V<sub>N(DC)</sub>)**

This is the voltage at which the device changes from the off (standby state) to the on (clamping state) and enters its conduction mode of operation. The voltage value is usually characterised at the 1mA point and has a specified minimum and maximum voltage range.





RoHS (Pb) **UltraMOV™ Varistor Series**



**Description**

The UltraMOV™ Metal Oxide Varistor Series is designed for applications requiring high peak surge current ratings and high energy absorption capability. UltraMOV™ varistors are primarily intended for use in AC Line Voltage applications such as Transient Voltage Surge Suppressors (TVSS), Uninterruptable Power Supplies (UPS), AC Power Taps, AC Power Meters, or other products that require voltage clamping of high transient surge currents from sources such as lightning, inductive load switching, or capacitor bank switching.

These devices are produced in radial lead package sizes of 7, 10, 14 and 20mm and offered in a variety of lead forms. UltraMOV™s are manufactured with recognized epoxy encapsulation and are rated for ambient temperatures up to 85°C with no derating. This Series is LASER-branded and is supplied in bulk, ammo pack (fan-fold), or tape and reel packaging.

**Agency Approvals**

Agency	Agency File Number
	E320116
	116895E
	LR91788
	42201-006

**Features**

- Lead-free and RoHS compliant option available. Please see the device and ratings specifications table for more information
- High peak surge current rating ( $I_{TM}$ ) up to 10kA, single 8 x 20 pulse, (20mm)
- Standard operating voltage range compatible with common AC line voltages (130  $V_{AC}$  to 625  $V_{AC}$ )
- Characterized for maximum standby current (Leakage)
- Custom voltage types available
- Standard lead form and lead space options

ULTRAMOV™ Series

**Absolute Maximum Ratings**

• For ratings of individual members of a series, see Device Ratings and Specifications chart

Continuous	UltraMOV™ Series	Units
Steady State Applied Voltage:		
DC Voltage Range ( $V_{M(AC)RMS}$ )	130 to 625	V
Transients:		
Single-Pulse Peak Current ( $I_{TM}$ ) 8x20 $\mu$ s Wave (See Figure 2)	1,750 to 10,000	A
Single-Pulse Energy Range ( $W_{TM}$ ) 2ms Square Wave	12.5 to 400	J
Operating Ambient Temperature Range ( $T_A$ )	-55 to +85	°C
Storage Temperature Range ( $T_{STG}$ )	-55 to +125	°C
Temperature Coefficient ( $\alpha^V$ ) of Clamping Voltage ( $V_C$ ) at Specified Test Current	<0.01	%/°C
Hi-Pot Encapsulation (COATING Isolation Voltage Capability)	2500	V
COATING Insulation Resistance	1000	M $\Omega$

*CAUTION: Stresses above those listed in "Absolute Maximum Ratings" may cause permanent damage to the device. This is a stress only rating and operation of the device at these or any other conditions above those indicated in the operational sections of this specification is not implied.*

### UltraMOV™ Series Ratings & Specifications

Lead-free and RoHS Compliant Models		Standard Models		Maximum Rating (85°C)					Specifications (25°C)				
				Continuous		Transient			Varistor Voltage at 1mA DC Test Current		Maximum Clamping Voltage 8 x 20µs		Typical Capacitance
				RMS Volts	DC Volts	Energy 2ms	Peak Current 8 x 20µs						
Part Number	Branding	Part Number	Branding	V <sub>M(AC)</sub> (V)	V <sub>M(DC)</sub> (V)	W <sub>TM</sub> (J)	I <sub>TM</sub> 1 x Pulse (A)	I <sub>TM</sub> 2 x Pulse (A)	V <sub>NOM</sub> Min (V)	V <sub>NOM</sub> Max (V)	V <sub>C</sub> (V)	I <sub>PK</sub> (A)	f = 1MHz (pF)
V07E130P	P7V130	V07E130	7V130	130	170	12.5	1750	1200	184	226	340	10	180
V10E130P	P10V130	V10E130	10V130	130	170	25	3500	2500	184	226	340	25	450
V14E130P	P14V130	V14E130	14V130	130	170	50	6000	4500	184	226	340	50	1000
V20E130P	P20V130	V20E130	20V130	130	170	100	10000	6500	184	226	340	100	1900
V07E140P	P7V140	V07E140	7V140	140	180	13.5	1750	1200	200	240	360	10	160
V10E140P	P10V140	V10E140	10V140	140	180	27.5	3500	2500	200	240	360	25	400
V14E140P	P14V140	V14E140	14V140	140	180	55	6000	4500	200	240	360	50	900
V20E140P	P20V140	V20E140	20V140	140	180	110	10000	6500	200	240	360	100	1750
V07E150P	P7V150	V07E150	7V150	150	200	15	1750	1200	216	264	395	10	150
V10E150P	P10V150	V10E150	10V150	150	200	30	3500	2500	216	264	395	25	360
V14E150P	P14V150	V14E150	14V150	150	200	60	6000	4500	216	264	395	50	800
V20E150P	P20V150	V20E150	20V150	150	200	120	10000	6500	216	264	395	100	1600
V07E175P	P7V175	V07E175	7V175	175	225	17	1750	1200	243	297	455	10	130
V10E175P	P10V175	V10E175	10V175	175	225	35	3500	2500	243	297	455	25	350
V14E175P	P14V175	V14E175	14V175	175	225	70	6000	4500	243	297	455	50	700
V20E175P	P20V175	V20E175	20V175	175	225	135	10000	6500	243	297	455	100	1400
V07E230P	P7V230	V07E230	7V230	230	300	20	1750	1200	324	396	595	10	100
V10E230P	P10V230	V10E230	10V230	230	300	42	3500	2500	324	396	595	25	250
V14E230P	P14V230	V14E230	14V230	230	300	80	6000	4500	324	396	595	50	550
V20E230P	P20V230	V20E230	20V230	230	300	160	10000	6500	324	396	595	100	1100
V07E250P	P7V250	V07E250	7V250	250	320	25	1750	1200	351	429	650	10	90
V10E250P	P10V250	V10E250	10V250	250	320	50	3500	2500	351	429	650	25	220
V14E250P	P14V250	V14E250	14V250	250	320	100	6000	4500	351	429	650	50	500
V20E250P	P20V250	V20E250	20V250	250	320	170	10000	6500	351	429	650	100	1000
V07E275P	P7V275	V07E275	7V275	275	350	28	1750	1200	387	473	710	10	80
V10E275P	P10V275	V10E275	10V275	275	350	55	3500	2500	387	473	710	25	200
V14E275P	P14V275	V14E275	14V275	275	350	110	6000	4500	387	473	710	50	450
V20E275P	P20V275	V20E275	20V275	275	350	190	10000	6500	387	473	710	100	900
V07E300P	P7V300	V07E300	7V300	300	385	30	1750	1200	423	517	775	10	70
V10E300P	P10V300	V10E300	10V300	300	385	60	3500	2500	423	517	775	25	180
V14E300P	P14V300	V14E300	14V300	300	385	125	6000	4500	423	517	775	50	400
V20E300P	P20V300	V20E300	20V300	300	385	250	10000	6500	423	517	775	100	800
V07E320P	P7V320	V07E320	7V320	320	420	32	1750	1200	459	561	840	10	65
V10E320P	P10V320	V10E320	10V320	320	420	67	3500	2500	459	561	840	25	170
V14E320P	P14V320	V14E320	14V320	320	420	136	6000	4500	459	561	840	50	380
V20E320P	P20V320	V20E320	20V320	320	420	273	10000	6500	459	561	840	100	750
V07E385P	P7V385	V07E385	7V385	385	505	36	1750	1200	558	682	1025	10	60
V10E385P	P10V385	V10E385	10V385	385	505	75	3500	2500	558	682	1025	25	160
V14E385P	P14V385	V14E385	14V385	385	505	150	6000	4500	558	682	1025	50	360
V20E385P	P20V385	V20E385	20V385	385	505	300	10000	6500	558	682	1025	100	700
V07E420P	P7V420	V07E420	7V420	420	560	40	1750	1200	612	748	1120	10	55
V10E420P	P10V420	V10E420	10V420	420	560	80	3500	2500	612	748	1120	25	140
V14E420P	P14V420	V14E420	14V420	420	560	160	6000	4500	612	748	1120	50	300
V20E420P	P20V420	V20E420	20V420	420	560	320	10000	6500	612	748	1120	100	600
V07E440P	P7V440	V07E440	7V440	440	585	44	1750	1200	643	787	1180	10	50
V10E440P	P10V440	V10E440	10V440	440	585	85	3500	2500	643	787	1180	25	130
V14E440P	P14V440	V14E440	14V440	440	585	170	6000	4500	643	787	1180	50	260
V20E440P	P20V440	V20E440	20V440	440	585	340	10000	6500	643	787	1180	100	500
V07E460P	P7V460	V07E460	7V460	460	615	48	1750	1200	675	825	1240	10	45

**UltraMOV™ Series Ratings & Specifications (Continued...)**

Lead-free and RoHS Compliant Models		Standard Models		Maximum Rating (85°C)					Specifications (25°C)				
				Continuous		Transient			Varistor Voltage at 1mA DC Test Current		Maximum Clamping Voltage 8 x 20µs		Typical Capacitance
				RMS Volts	DC Volts	Energy 2ms	Peak Current 8 x 20µs						
Part Number	Branding	Part Number	Branding	V <sub>M(AC)</sub> (V)	V <sub>M(DC)</sub> (V)	W <sub>TM</sub> (J)	I <sub>TM</sub> 1 x Pulse (A)	I <sub>TM</sub> 2 x Pulse (A)	V <sub>NOM</sub> Min (V)	V <sub>NOM</sub> Max (V)	V <sub>C</sub> (V)	I <sub>PK</sub> (A)	f = 1MHz (pF)
V10E460P	P10V460	V10E460	10V460	460	615	90	3500	2500	675	825	1240	25	120
V14E460P	P14V460	V14E460	14V460	460	615	180	6000	4500	675	825	1240	50	220
V20E460P	P20V460	V20E460	20V460	460	615	360	10000	6500	675	825	1240	100	400
V10E510P	P10V510	V10E510	10V510	510	670	80	3500	2500	738	902	1355	25	110
V14E510P	P14V510	V14E510	14V510	510	670	165	6000	4500	738	902	1355	50	200
V20E510P	P20V510	V20E510	20V510	510	670	325	10000	6500	738	902	1355	100	350
V10E550P	P10V550	V10E550	10V550	550	745	90	3500	2500	819	1001	1500	25	100
V14E550P	P14V550	V14E550	14V550	550	745	180	6000	4500	819	1001	1500	50	180
V20E550P	P20V550	V20E550	20V550	550	745	360	10000	6500	819	1001	1500	100	300
V10E625P	P10V625	V10E625	10V625	625	825	100	3500	2500	900	1100	1650	25	90
V14E625P	P14V625	V14E625	14V625	625	825	200	6000	4500	900	1100	1650	50	160
V20E625P	P20V625	V20E625	20V625	625	825	400	10000	6500	900	1100	1650	100	250

NOTE:

1. Average power dissipation of transients should not exceed 0.25W, 0.4W, 0.6W and 1.0W for 7mm, 10mm, 14mm, and 20mm model sizes, respectively.

**Power Dissipation Ratings**

Should transients occur in rapid succession, the average power dissipation is the energy (watt-seconds) per pulse times the number of pulses per second. The power so developed must be within the specifications shown on the Device Ratings and Specifications Table for the specific device. Furthermore, the operating values need to be derated at high temperatures as shown in above. Because varistors can only dissipate a relatively small amount of average power they are, therefore, not suitable for repetitive applications that involve substantial amounts of average power dissipation.

**Current Energy and Power Derating Curve**

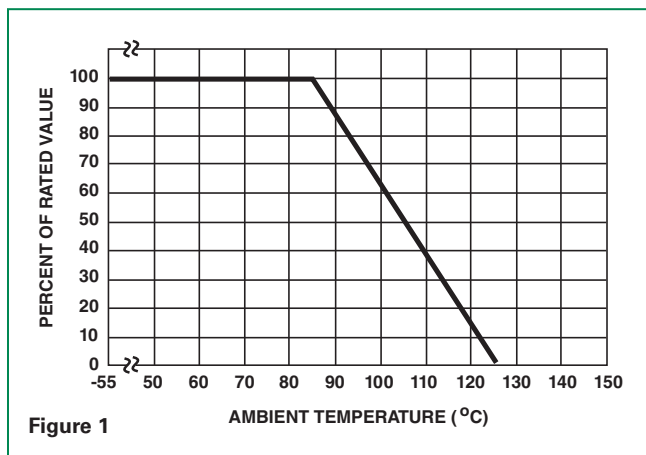


Figure 1

**Peak Pulse Current Test Waveform**

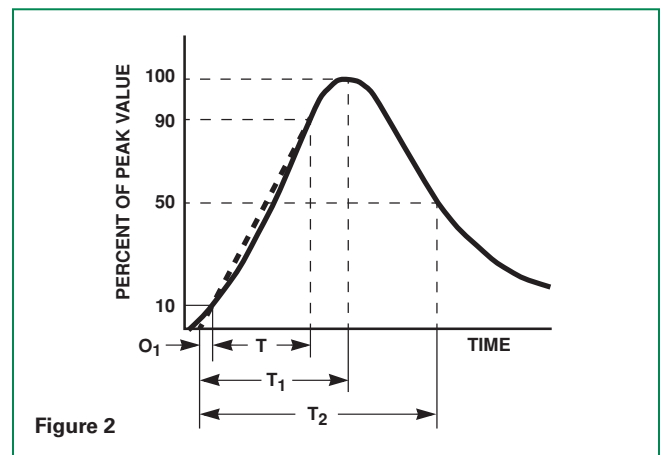


Figure 2

O<sub>1</sub> = Virtual Origin of Wave  
 T = Time from 10% to 90% of Peak  
 T<sub>1</sub> = Rise Time = 1.25 x T  
 T<sub>2</sub> = Decay Time

**Example** - For an 8/20 µs Current Waveform:

8µs = T<sub>1</sub> = Rise Time  
 20µs = T<sub>2</sub> = Decay Time

Transient V-I Characteristics Curves

Maximum Clamping Voltage for 7mm Parts

V7E130(P)-V7E460(P)

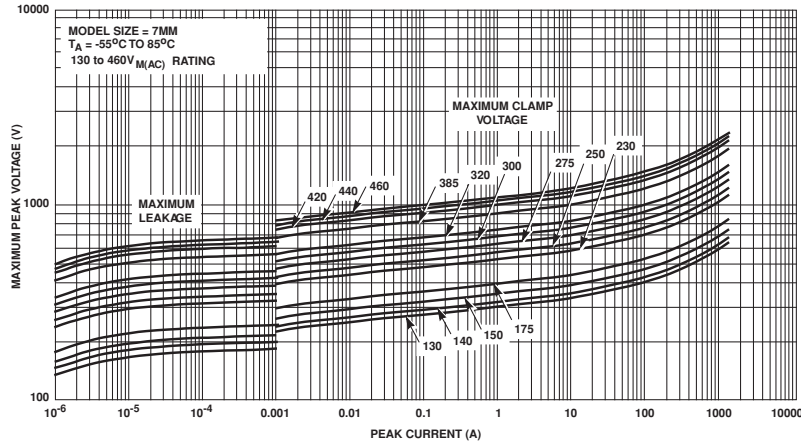


Figure 3

Maximum Clamping Voltage for 10mm Parts

V10E130(P)-V10E625(P)

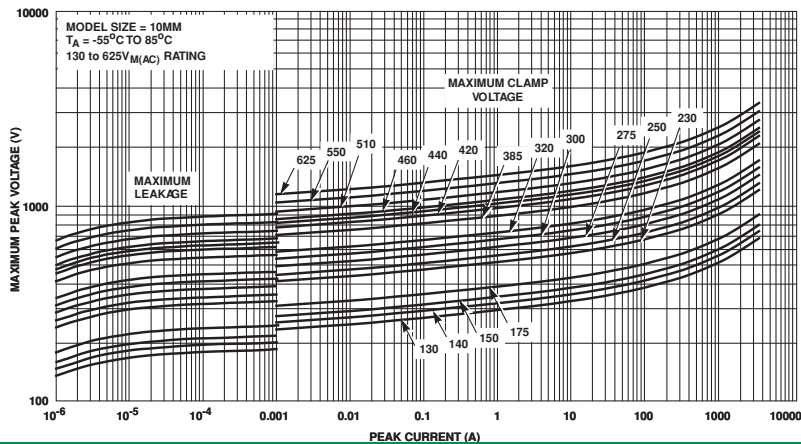


Figure 4

Maximum Clamping Voltage for 14mm Parts

V14E130(P) - V14E625(P)

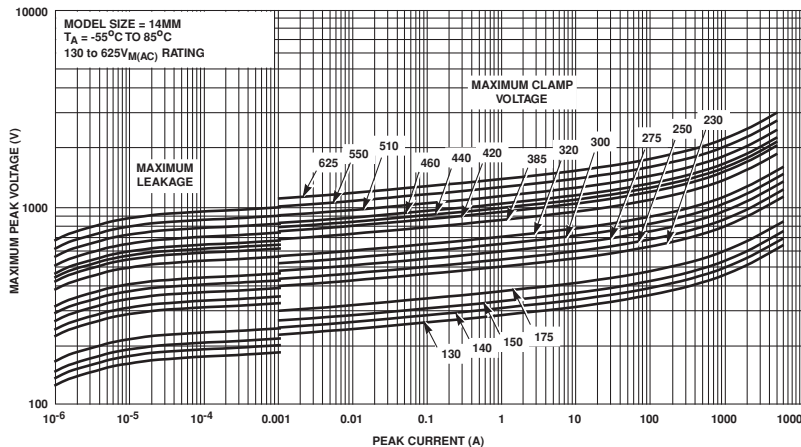
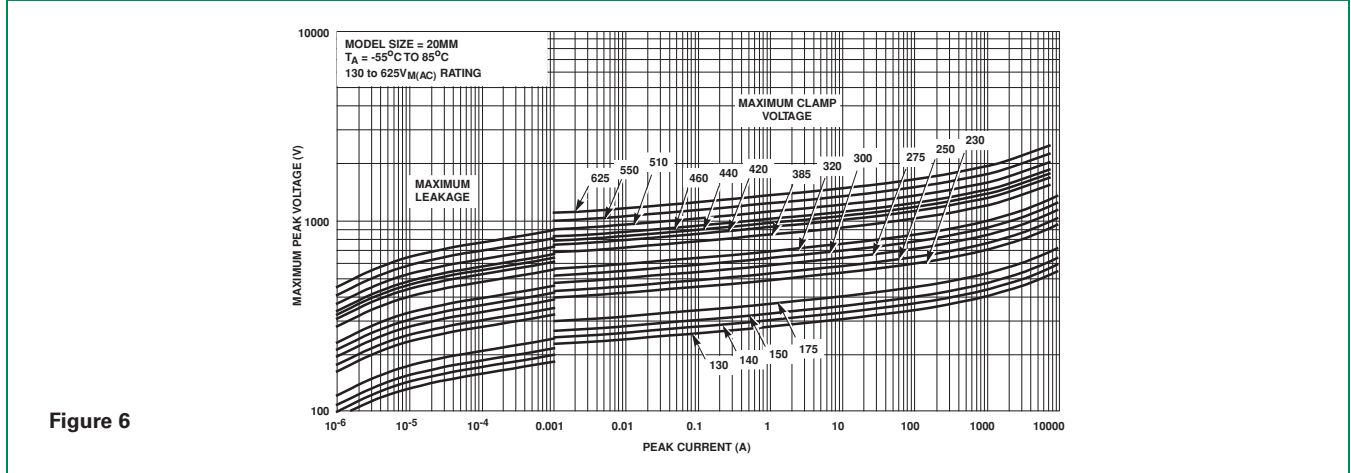


Figure 5

Transient V-I Characteristics Curves (Continued...)

Maximum Clamping Voltage for 20mm Parts

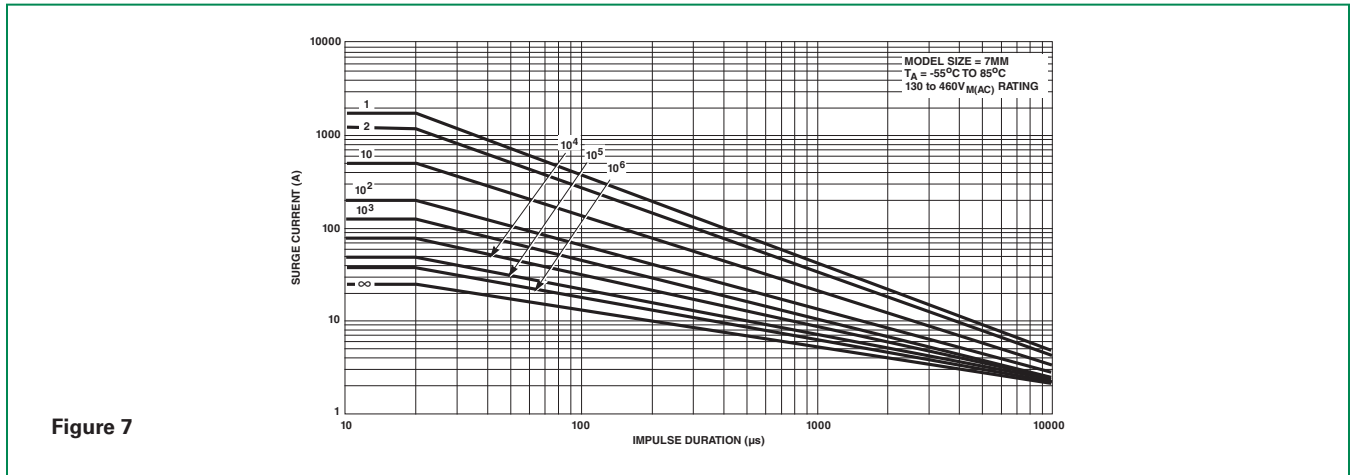
V20E130(P) - V20E625(P)



Pulse Rating Curves

Repetitive Surge Capability for 7mm Parts

V7E130(P) - V7E460(P)



Pulse Rating Curves (Continued...)

Repetitive Surge Capability for 10mm Parts

V10E130(P) - V10E625(P)

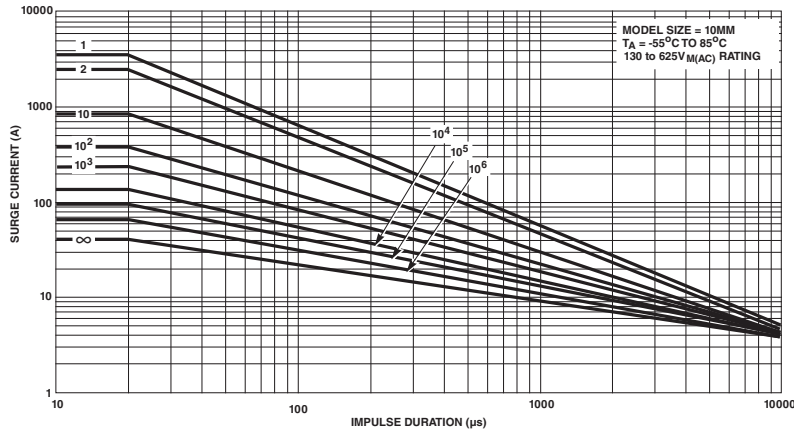


Figure 8

Repetitive Surge Capability for 14mm Parts

V14E130(P) - V14E625(P)

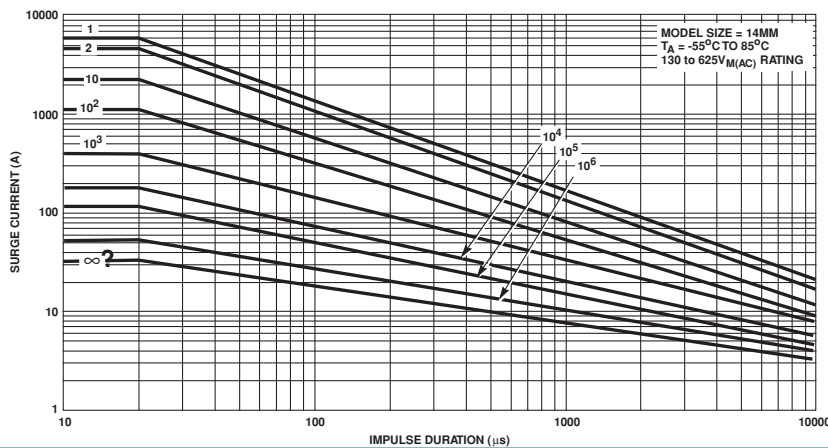


Figure 9

Repetitive Surge Capability for 20mm Parts

V20E130(P) - V20E625(P)

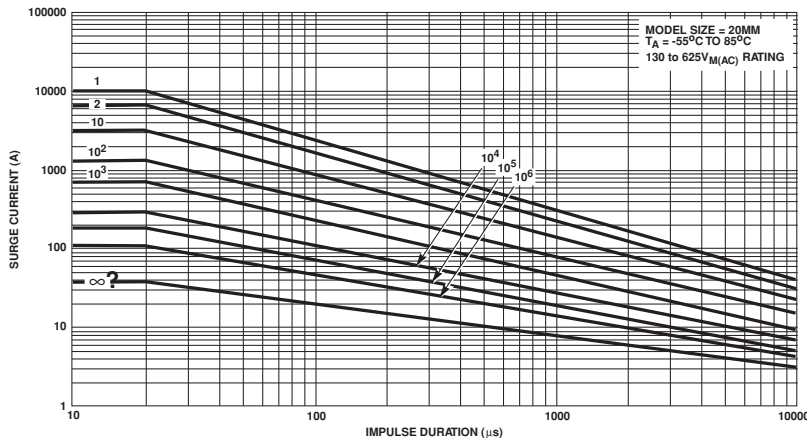


Figure 10



### Wave Solder Profile

#### Non Lead-free Profile

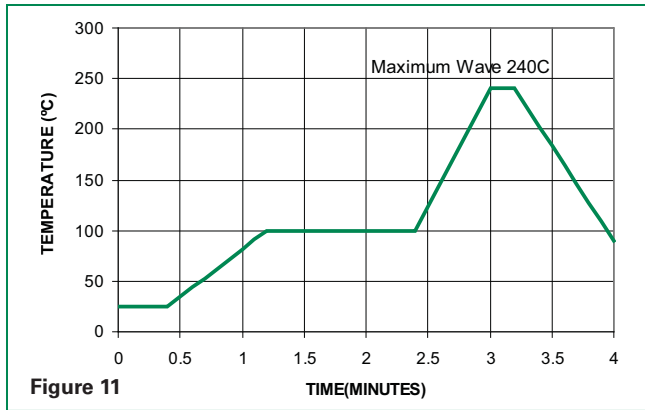


Figure 11

#### Lead-free Profile

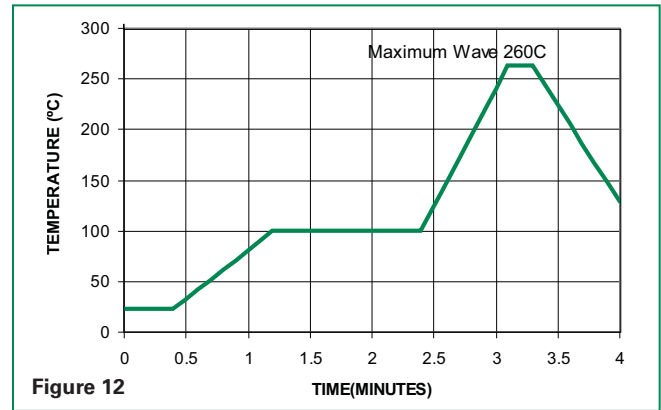


Figure 12

### Physical Specifications

<b>Lead Material</b>	Tin-C coated Copper Wire
<b>Soldering Characteristics</b>	Solderability per MIL-STD-202, Method 208E
<b>Insulating Material</b>	Cured, flame retardant epoxy polymer meets UL94V-0 requirements
<b>Device Labeling</b>	Marked with LF, voltage, UL/CSA logos, and date code

### Environmental Specifications

<b>Operating/Storage Temperature</b>	-55°C to +85°C/-55°C to +125°C
<b>Humidity Aging</b>	+85°C, 85% RH, 1000 hours +/-10% typical voltage change
<b>Thermal Shock</b>	+85°C to -40°C 5 times +/-10% typical voltage change
<b>Solvent Resistance</b>	MIL-STD-202, Method 215F
<b>Moisture Sensitivity</b>	Level 1, J-STD-020C

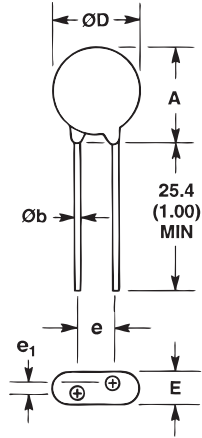
ULTRAMOV™ Series

### UltraMOV™ Series Varistors for Hi-Temperature Operating Conditions:

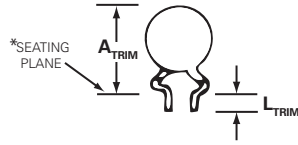
- Phenolic Coated UltraMOV™ Series devices are available with improved maximum operating temperature 125°C.
- These devices also have improved temperature cycling performance capability.
- Ratings and Specifications are as per standard UltraMOV™ Series except Hi-Pot Encapsulation (Isolation Voltage Capability) = 500V.
- Phenolic Coating is HALOGEN FREE. To order: change 'E' (Epoxy coating) in part number to 'P' (Phenolic coating; e.g. V20P230). See Part Numbering System section of this series for more information.
- UL Approval for Phenolic Coating parts to E75961 Pending.
- Contact factory for further details.

### Product Dimensions (mm)

#### Lead form options L1 and L3 (refer to table below)



#### Lead form options L2 and L4 (refer to table below)



\*Seating plane interpretation per IEC-717  
(not available on tape or ammo pack)

Dimension	V <sub>RMS</sub> Voltage Model	7mm Size		10mm Size		14mm Size		20mm Size	
		Min. mm (in)	Max. mm (in)	Min. mm (in)	Max. mm (in)	Min. mm (in)	Max. mm (in)	Min. mm (in)	Max. mm (in)
A	130-320	-	12 (0.472)	-	16 (0.630)	-	20 (0.787)	-	26.5 (1.043)
	385-625	-	13 (0.512)	-	17 (0.689)	-	20.5 (0.807)	-	28 (1.102)
ØD	All	-	9 (0.354)	-	12.5 (0.492)	-	17 (0.669)	-	23 (0.906)
e (Note 2)	All	4 (0.157)	6 (0.236)	6.5 (0.256)	8.5 (0.335)	6.5 (0.256)	8.5 (0.335)	9 (0.354)	11 (0.433)
e <sub>1</sub> (Note 3)	130-320	1.5 (0.059)	3.5 (0.138)	1.5 (0.059)	3.5 (0.138)	1.5 (0.059)	3.5 (0.138)	1.5 (0.059)	3.5 (0.138)
	385-625	2.5 (0.098)	5.5 (0.217)	2.5 (0.098)	5.5 (0.217)	2.5 (0.098)	5.5 (0.217)	2.5 (0.098)	5.5 (0.217)
E	130-320	-	5.6 (0.220)	-	5.6 (0.220)	-	5.6 (0.220)	-	5.6 (0.220)
	385-510	-	7.3 (0.287)	-	7.3 (0.287)	-	7.3 (0.287)	-	7.3 (0.287)
	550-625	-	8.3 (0.327)	-	8.3 (0.327)	-	8.3 (0.327)	-	8.3 (0.327)
ø b	All	0.585 (0.023)	0.685 (0.027)	0.76 (0.030)	0.86 (0.034)	0.76 (0.030)	0.86 (0.034)	0.76 (0.030) (Note 2)	0.86 (0.034) (Note 2)
A <sub>TRIM</sub>	All	-	15 (0.591)	-	19.5 (0.768)	-	22.5 (0.886)	-	29.0 (1.142)
L (L2)	All	25.4 (1.00)	-	25.4 (1.00)	-	25.4 (1.00)	-	25.4 (1.00)	-
*L (L4)	All	2.41 (0.095)	4.69 (0.185)	2.41 (0.095)	4.69 (0.185)	2.41 (0.095)	4.69 (0.185)	2.41 (0.095)	4.69 (0.185)

NOTES:

1. Measurements displayed in Millimeters (Inches in parentheses).
2. Standard lead space.
3. For in-line lead option L3, dimension e, is "zero". Straight lead form option L1 shown.

For information about bulk packaging quantities, please refer to the Ordering Notes section at the end of this document.

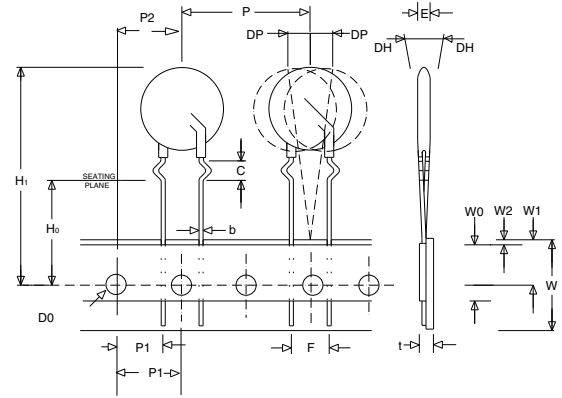
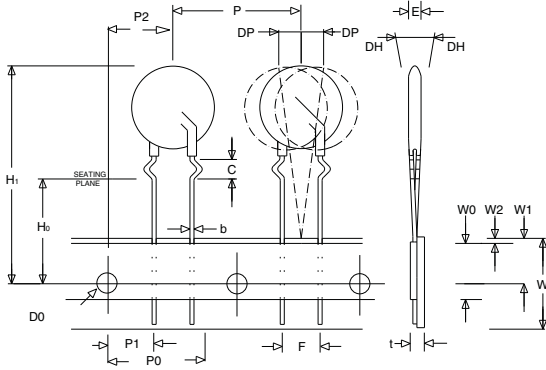
**Tape Specifications for Reel and Ammo Pack Items** (Refer to dimensions on following page)

**7mm Devices**

**10, 14 and 20mm Devices**

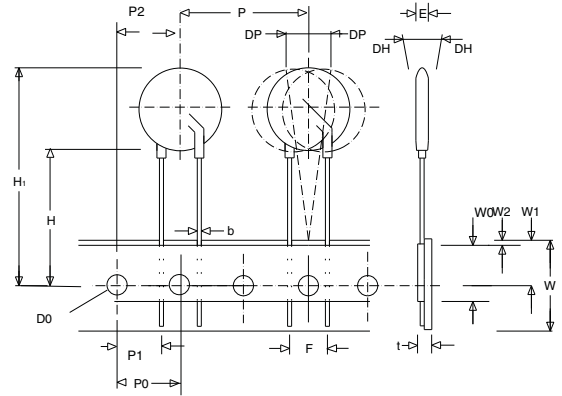
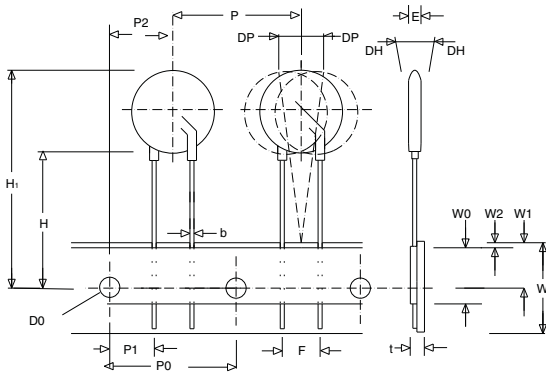
CRIMPED LEADS "L2"

CRIMPED LEADS "L2"



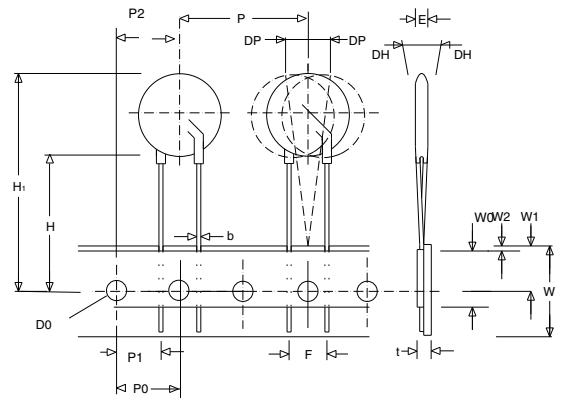
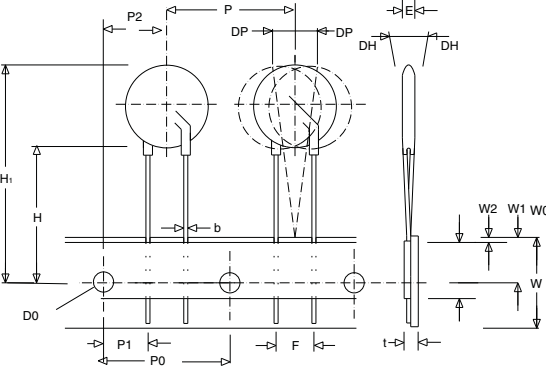
INLINE LEADS "L3"

INLINE LEADS "L3"



STRAIGHT LEADS "L1"

STRAIGHT LEADS "L1"



ULTRAMOV™ Series

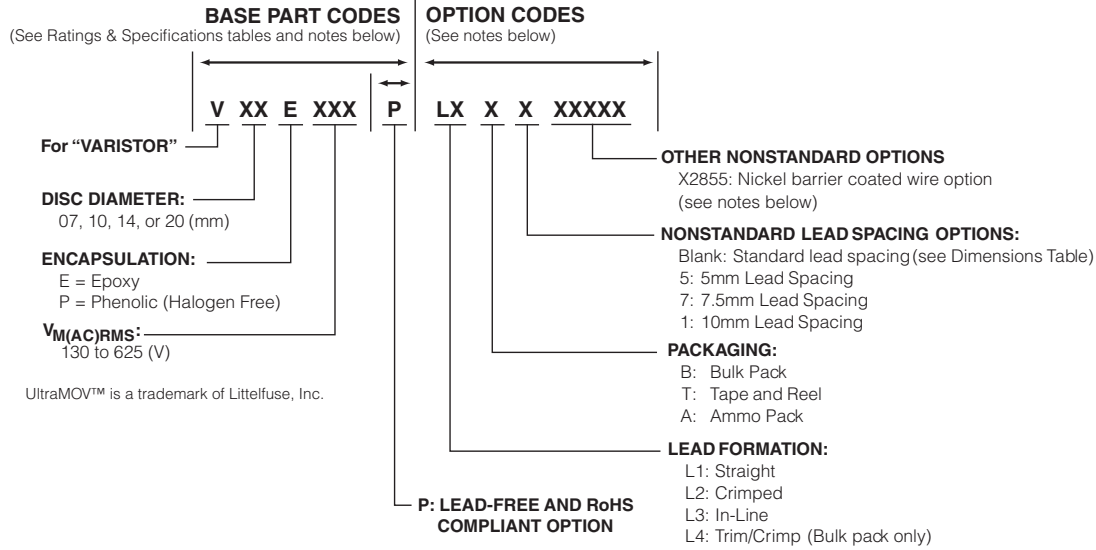
### Tape Specifications for Reel and Ammo Pack Items (Refer to drawings on previous page)

- Conforms to ANSI and EIA specifications.
- Can be supplied to IEC Publication 286-2.
- Radial devices on tape are offered with crimped leads, straight leads, or in-line leads. See Ordering Information.
- For 10mm devices 'P' (component pitch) is 12.7mm when 'F' (lead space) is 5mm.
- 7mm parts are available on tape and reel up to 460 VAC only
- 10mm parts are available on tape and reel up to 510 VAC only
- 14mm and 20mm parts are available on tape and reel up to 550 VAC only
- 7mm devices with 7.5mm lead spacing option will be taped at 25.4mm component pitch and 500 pieces per reel
- 10mm devices with 5.0mm lead spacing option will be taped at 12.7mm component pitch and 1000 pieces per reel

Symbol	Description	Model Size			
		7mm	10mm	14mm	20mm
<b>B<sub>1</sub></b>	Component Top to Seating Plane	15 Max	19.5 Max	22.5 Max	29 Max
<b>C</b>	Crimp Length	2.4 Typ	2.6 Typ	2.6 Typ	2.6 Typ
<b>P</b>	Pitch of Component	12.7 +/- 1.0	25.4 +/- 1.0	25.4 +/- 1.0	25.4 +/- 1.0
<b>P<sub>0</sub></b>	Feed Hole Pitch	12.7 +/- 0.2	12.7 +/- 0.2	12.7 +/- 0.2	12.7 +/- 0.2
<b>P<sub>1</sub></b>	Feed Hole Center to Pitch	3.85 +/- 0.7	8.85 +/- 0.7	8.85 +/- 0.7	7.70 +/- 0.7
<b>P<sub>2</sub></b>	Hole Center to Component Center	6.35 +/- 0.7	12.7 +/- 0.7	12.7 +/- 0.7	12.7 +/- 0.7
<b>F</b>	Lead to Lead Distance	5.0 +/- 0.8	7.5 +/- 0.8	7.5 +/- 0.8	10.0 +/- 0.8
<b>Δh</b>	Component Alignment	2.0 Max	2.0 Max	2.0 Max	2.0 Max
<b>W</b>	Tape Width	18.0 +1.0 / -0.5	18.0 +1.0 / -0.52	18.0 +1.0 / -0.5	18.0 +1.0 / -0.5
<b>W<sub>0</sub></b>	Hold Down Tape Width	12.0 +/- 0.3	12.0 +/- 0.3	12.0 +/- 0.3	12.0 +/- 0.3
<b>W<sub>1</sub></b>	Hole Position	9.0 +0.75 / -0.50	9.0 +0.75 / - 0.50	9.0 +0.75 / 0.50	9.0 +0.75 / -0.50
<b>W<sub>2</sub></b>	Hold Down Tape Position	0.5 Max	0.5 Max	0.5 Max	0.5 Max
<b>H</b>	Height from Tape Center to Component Base	18.0 +2.0 / -0.0	18.0 +2.0 / -0.0	18.0 +2.0 / -0.0	18.0 +2.0 / -0.0
<b>H<sub>0</sub></b>	Seating Plane Height	16.0 +/- 0.5	16.0 +/- 0.5	16.0 +/- 0.5	16.0 +/- 0.5
<b>H<sub>1</sub></b>	Component Height	32.0 Max	36.0 Max	40.0 Max	46.5 Max
<b>D<sub>0</sub></b>	Feed Hole Diameter	4.0 +/- 0.2	4.0 +/- 0.2	4.0 +/- 0.2	4.0 +/- 0.2
<b>t</b>	Total Tape Thickness	0.7 +/- 0.2	0.7 +/- 0.2	0.7 +/- 0.2	0.7 +/- 0.2
<b>Δp</b>	Component Alignment	3° Max, 1.00mm	3° Max, 1.00mm	3° Max, 1.00mm	3° Max, 1.00mm

For information on tape and reel packaging quantities, please refer to the Ordering Notes section at the end of this document.

### Part Numbering System



### Ordering Notes:

For standard parts, use the **BASE PART** designator only.

For parts with non-standard options (such as additional form, packaging and lead space options) use, **BASE PART + OPTION CODE**.

**OPTION CODE** items are subject to availability and minimum order requirements. Please contact a Littelfuse representative if you require additional information

### BASE PART CODES:

#### Lead-free/RoHS Designator:

For Lead-free and RoHS compliant parts add "P" after the **BASE PART** number and before any other **OPTION CODE**:

Standard Model	Order As
V07E130	V07E130 <b>P</b>

Standard Model with Option	Order As
V07E130L1B5	V07E130 <b>PL</b> 1B5

### OPTION CODES:

#### X2855: Nickel Barrier COATED WIRE OPTION

All standard parts use Tin-coated Copper Wire Nickel Barrier Coated Wire is available as an option, consisting of Copper Wire with a flashing of Nickel followed by a top coating of Tin.

**To order:** append standard model **BASE PART** number with "X2855." Example:

Standard Model	Order As
V18ZA40	V18ZA40 <b>X2855</b>

### PACKAGING:

Littelfuse UltraMOV™ varistors are shipped standard in bulk pack with straight leads and lead spacing outlined in the dimensions sections of this document. Contact a Littelfuse representative to discuss non-standard options.

### Standard Part Default Conditions

Device Size	Part #	Lead Space	Packaging
7mm	V07E-	5.0-/±1	Bulk
10mm	V10E-	7.5-/±1	Bulk
14mm	V14E-	7.5-/±1	Bulk
20mm	V20E-	10.0-/±1	Bulk

### Standard Bulk Pack Quantity

Varistor Voltage	Standard Bulk Pack Quantity			
	Varistor Model Size			
	7mm	10mm	14mm	20mm
130 – 275	1500	1000	700	500
300 – 460	1500	700	600	400
510 – 625	1500	700	500	400

### Tape & Reel Quantity

Varistor Voltage	Shipping Quantity Per Reel			
	7mm	10mm	14mm	20mm
130 – 275	1000	500	500	500
300 – 625	1000	500	400	400





**RoHS** **Pb** **UltraMOV™ 25S Varistor Series**

**Description**

The UltraMOV™ 25S Varistor Series is designed for applications requiring high peak surge current ratings and high energy absorption capability. UltraMOV™ varistors are primarily intended for use in AC Line Voltage applications such as Surge Protective Devices (SPD), Uninterruptable Power Supplies (UPS), AC Power Taps, AC Power Meters, or other products that require voltage clamping of high transient surge currents from sources such as lightning, inductive load switching, or capacitor bank switching.

These devices have 25mm square forms are produced in a radial lead package and offered with straight leads. UltraMOVs are manufactured with recognized epoxy encapsulation and are rated for ambient temperatures up to 85°C with no derating. This 25S Series is LASER-branded and is supplied in bulk packaging.

**Agency Approvals**

Agency	Agency File Number	Status
	E320116	Approved
	091788	Approved

**Features**

- Lead-free and RoHS compliant.
- High peak surge current rating ( $I_{TM}$ ) 22kA, single 8/20 $\mu$ s pulse, (25mm)
- 40kA rating when 2 devices paralleled (VN(DC) matched within +/- 5%, contact factory for special selections
- Standard operating voltage range compatible with common AC line voltages (115 to 750VAC)
- Characterized for maximum standby current (Leakage)
- Custom voltage types available
- Standard lead form and lead space options

**ULTRAMOV™ 25S Series**
**Absolute Maximum Ratings**

• For ratings of individual members of a series, see Device Ratings and Specifications chart

Continuous	UltraMOV™ 25S Series	Units
Steady State Applied Voltage:		
AC Voltage Range ( $V_{MIACIRMS}$ )	115 to 750	V
DC Voltage Range ( $V_{MDC}$ )	150 to 970	V
Transients:		
Peak Pulse Current ( $I_{TM}$ ) 8x20 $\mu$ s Current Wave Single Pulse	22,000	A
Single-Pulse Energy Capability ( $W_{TM}$ ) 2ms Current Wave	230 to 890	J
Operating Ambient Temperature Range ( $T_A$ )	-55 to +85	°C
Storage Temperature Range ( $T_{STG}$ )	-55 to +125	°C
Temperature Coefficient (a') of Clamping Voltage ( $V_C$ ) at Specified Test Current	<0.01	%/C
Hi-Pot Encapsulation (COATING Isolation Voltage Capability)	2500	V
Dielectric Withstand DC for 1 min per MIL-STD-202, Method 301	1000	M $\Omega$

**CAUTION:** Stresses above those listed in "Absolute Maximum Ratings" may cause permanent damage to the device. This is a stress only rating and operation of the device at these or any other conditions above those indicated in the operational sections of this specification is not implied.

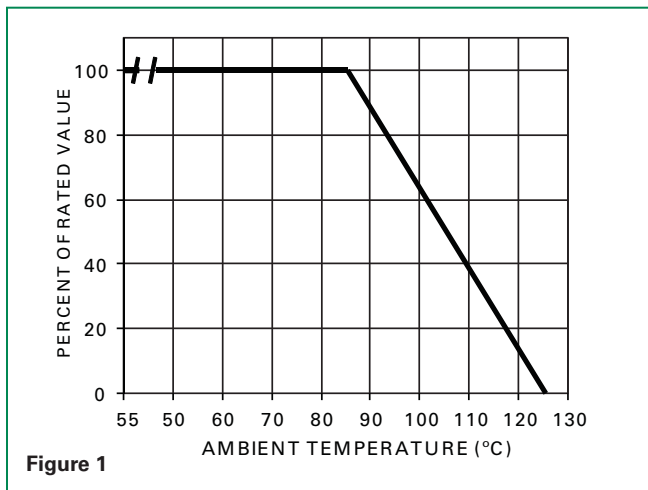


### UltraMOV™ 25S Series Ratings & Specifications

Part Number	Branding	Maximum Rating (85°C)				Specifications (25°C)				
		Continuous		Transient		Varistor Voltage at 1mA DC Test Current		Maximum Clamping Voltage at 100A, 8 x 20µs	UL 1449 ed.3 Voltage Protection Rating	Typical Capacitance f = 1MHz
		AC Volts	DC Volts	Energy 2ms	Peak Surge Current 8 x 20µs					
		V <sub>M(AC)RMS</sub>	V <sub>M(DC)</sub>	W <sub>TM</sub> 1 x Pulse	I <sub>TM</sub> 1 x Pulse	V <sub>NOM</sub> Min	V <sub>NOM</sub> Max	V <sub>C</sub>	VPR	C
(V)	(V)	(J)	(A)	(V)		(V)		(pF)		
V25S115P	P25S115	115	150	230	22000	162	198	295	400	4500
V25S130P	P25S130	130	170	255	22000	184	226	335	500	3900
V25S140P	P25S140	140	180	285	22000	200	240	355	500	3500
V25S150P	P25S150	150	200	300	22000	216	264	390	500	3200
V25S175P	P25S175	175	225	315	22000	243	297	450	600	2550
V25S230P	P25S230	230	300	400	22000	324	396	585	700	1900
V25S250P	P25S250	250	320	435	22000	351	429	640	800	1750
V25S275P	P25S275	275	350	470	22000	387	473	700	900	1610
V25S300P	P25S300	300	385	500	22000	423	517	765	1000	1450
V25S320P	P25S320	320	420	540	22000	459	561	825	1000	1350
V25S385P	P25S385	385	505	630	22000	558	682	1010	1200	1080
V25S420P	P25S420	420	560	655	22000	612	748	1100	1500	1000
V25S440P	P25S440	440	585	675	22000	643	787	1160	n/a	900
V25S460P	P25S460	460	615	690	22000	675	825	1220	n/a	870
V25S510P	P25S510	510	670	700	22000	738	902	1335	n/a	820
V25S550P	P25S550	550	745	765	22000	819	1001	1475	n/a	750
V25S625P	P25S625	625	825	800	22000	900	1100	1625	n/a	660
V25S750P	P25S750	750	970	890	22000	1080	1320	1950	n/a	550

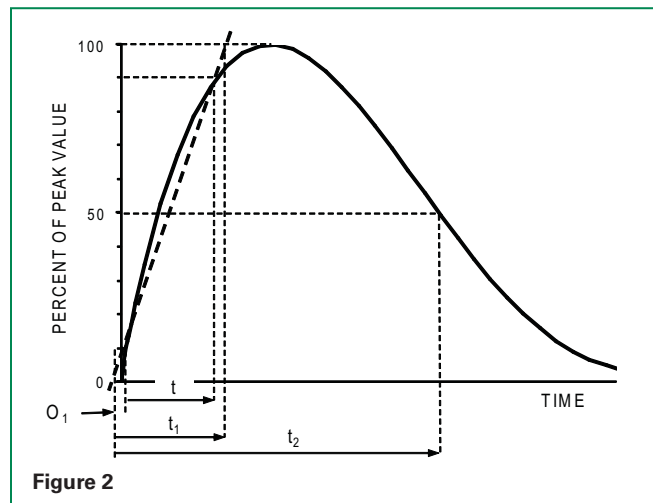
### Transient V-I Characteristics Curves

#### Peak Current, Energy and Power Derating Curve



For applications exceeding 85°C ambient temperature, the peak surge current and energy ratings must be reduced as shown above.

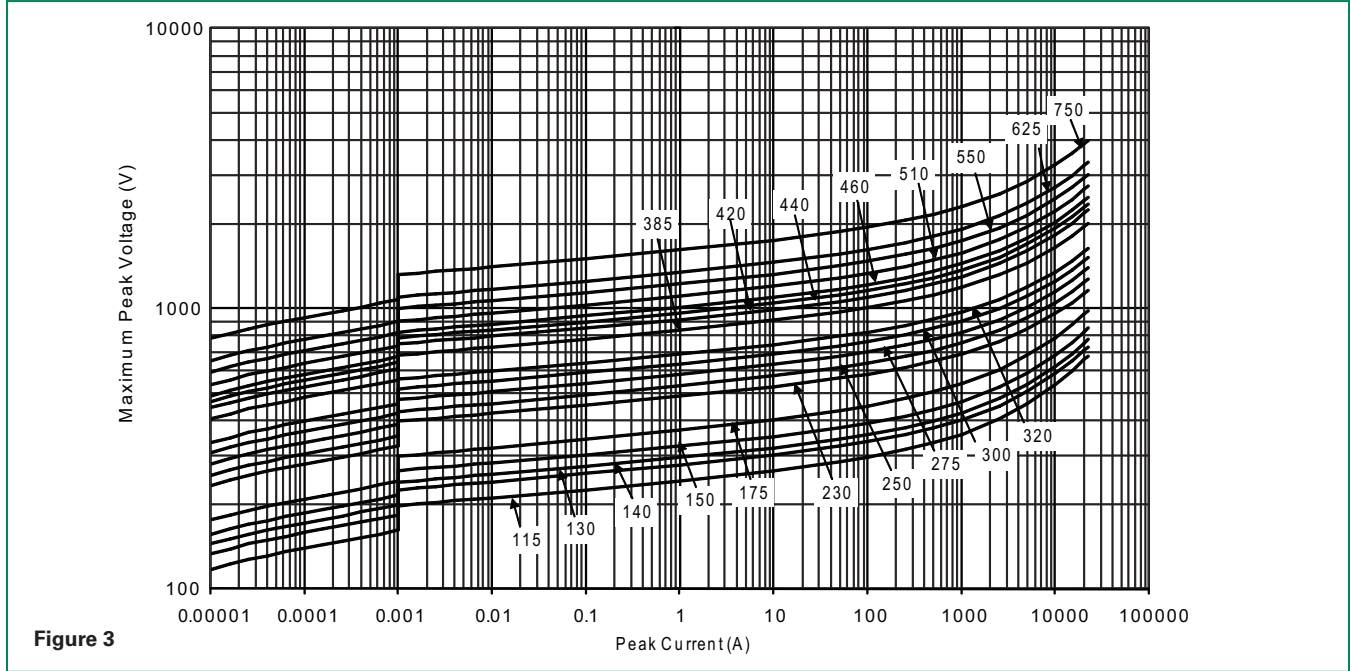
#### Peak Pulse Current Test Waveform for Clamping Voltage



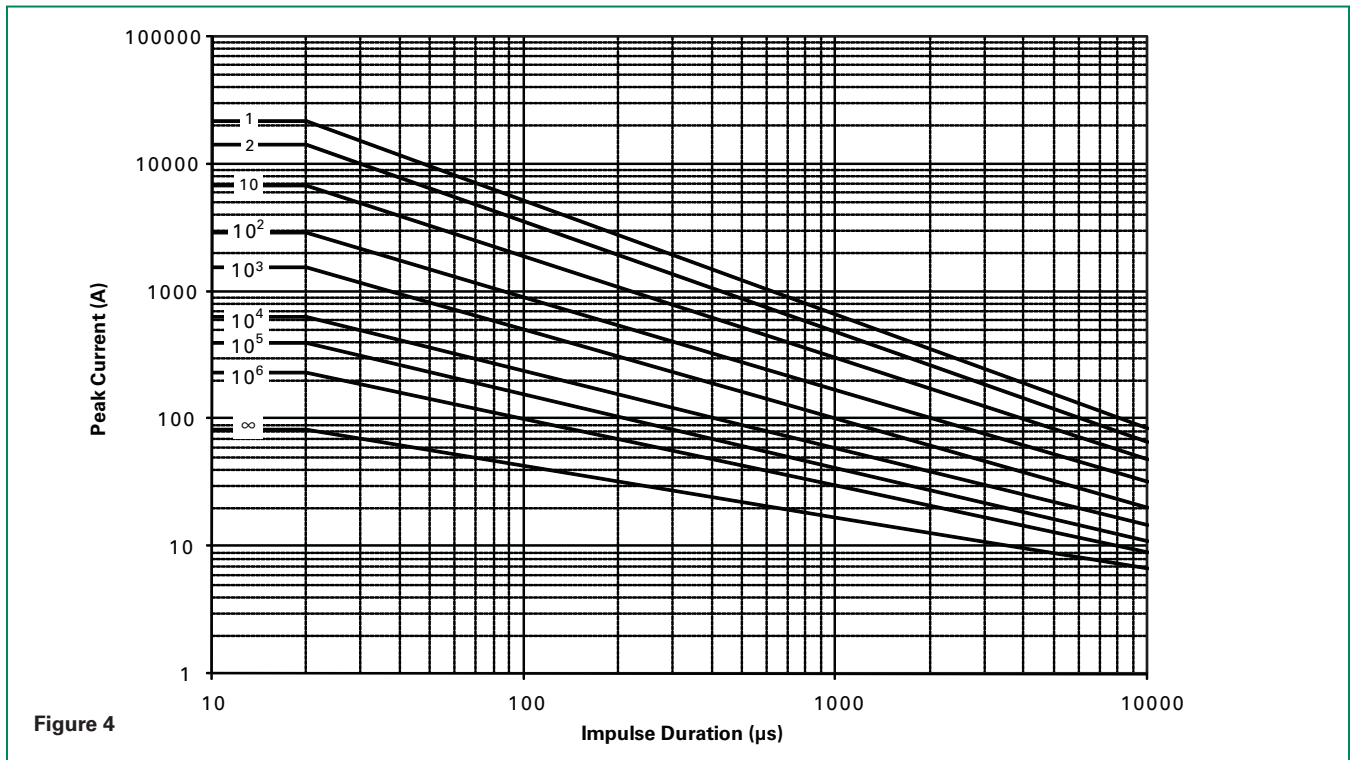
O<sub>1</sub> = Virtual Origin of Wave  
 T = Time from 10% to 90% of Peak  
 T<sub>1</sub> = Rise Time = 1.25 x T  
 T<sub>2</sub> = Decay Time

**Example** - For an 8/20 µs Current Waveform:  
 8µs = T<sub>1</sub> = Rise Time  
 20µs = T<sub>2</sub> = Decay Time

**V-I Limit Curves**



**Pulse Rating Curves**



ULTRAMOV™ 25S Series

**Wave Solder Profile**

**Non Lead-free Wave Solder Profile**

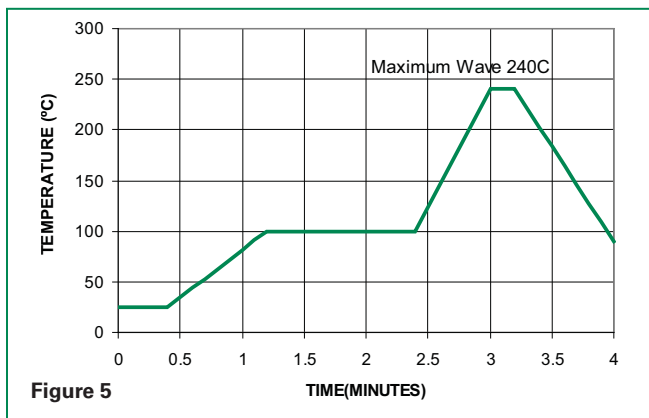


Figure 5

**Lead-free Wave Solder Profile**

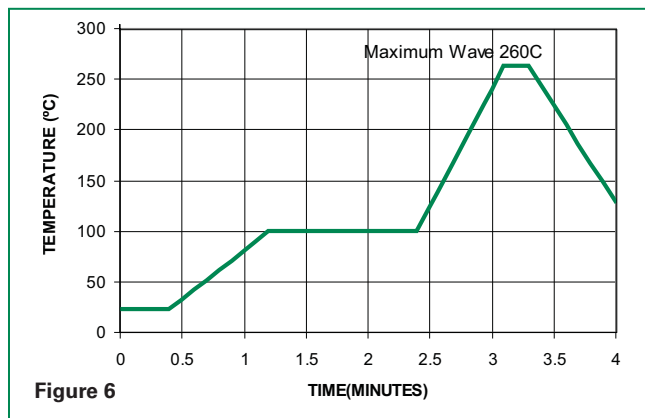


Figure 6

**Physical Specifications**

<b>Lead Material</b>	Tin-coated Copper wire
<b>Soldering Characteristics</b>	Solderability per MIL-STD-202, Method 208E
<b>Insulating Material</b>	Cured, flame retardant epoxy polymer meets UL94V-0 requirements
<b>Device Labeling</b>	Marked with LF, voltage, UL/CSA Logos, and date code

**Environmental Specifications**

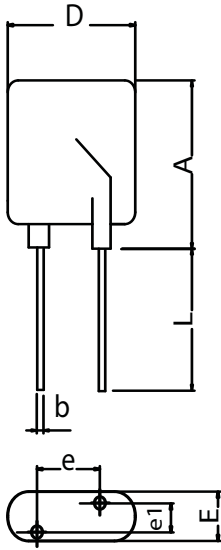
<b>Operating/Storage Temperature</b>	-55°C to +85°C/ -55°C to +125°C
<b>Passive Aging</b>	+85°C, 1000 hours +/-10% typical voltage change
<b>Humidity Aging</b>	+85°C, 85% RH, 1000 hours +/-10% typical voltage change
<b>Thermal Shock</b>	+85°C to -40°C 5 times +/-10% typical voltage change
<b>Solvent Resistance</b>	MIL-STD-202, Method 215F
<b>Moisture Sensitivity</b>	Level 1, J-STD-020C

**UltraMOV™ 25S Series Varistors for High-Temperature Operating Conditions:**

Phenolic coated devices are available with improved maximum operating temperature 125°C. These devices also have improved temperature cycling capability. Ratings and specifications are per standard series except Hi-Pot Encapsulation (Isolation Voltage Capability) = 500V.

**To order:** add 'X1347' to part number (e.g. V25S150PX1347). These devices are NOT UL, CSA, CECC or VDE certified. Contact factory for further details.

### Product Dimensions (mm)



	A max	b min	b max	D max	e min	e max	e1 min	e1 max	E max	L min
V25S115P	32.5	0.95	1.05	28	11.7	13.7	1.5	2.7	5.7	25.4
V25S130P							1.6	2.9	5.9	
V25S140P							1.7	3.0	6.0	
V25S150P							1.8	3.1	6.1	
V25S175P							1.9	3.3	6.3	
V25S230P							2.0	3.4	6.4	
V25S250P							2.1	3.5	6.5	
V25S275P							2.3	3.7	6.7	
V25S300P							2.4	3.9	6.9	
V25S320P							2.6	4.1	7.1	
V25S385P							3.0	4.7	7.7	
V25S420P							3.3	5.0	8.0	
V25S440P							3.4	5.2	8.2	
V25S460P							3.6	5.4	8.4	
V25S510P							1.6	3.4	8.7	
V25S550P							1.9	3.9	9.2	
V25S625P							2.3	4.3	9.6	
V25S750P	3.1	5.4	10.7							

### Notes

1. Additional optional lead form, packaging and lead spacing requirements are subject to availability and to minimum order requirements. Please contact factory for details.
2. Nickel Barrier Wire option (Suffix 'X2855') Standard parts use Tin-Coated Copper wire. Nickel Barrier Coated Wire is available as an option. This is Copper Wire with a flashing of Nickel, followed by a top coat of Tin. To order please add suffix 'X2855' to end of standard part number. Contact factory for more details if required.
3. UltraMOV 25S have been qualified as type 1 application by UL1449 edition 3, which allows Permanent Connection between the secondary of the service transformer and the line side of the service equipment overcurrent device, as well as the load side, including watt-hour meter socket enclosures and intended to be installed without an external overcurrent protective device.



RoHS  **C-III Varistor Series**







**Description**

The C-III Series of Metal-Oxide Varistors (MOVs) are specifically designed for applications requiring high surge energy absorption ratings and superior multiple pulse absorption rating. This is achieved through a special dielectric material formulation which also results in higher repetitive surge ratings than other MOV types.

The C-III Series is primarily intended for use in AC line Transient Voltage Surge Suppressor (TVSS) product environment and other similar applications requiring high transient energy and peak current capability in a relatively small package size.

**Agency Approvals**

Agency	Agency File Number
	E320116
	LR91788
	116895E
	42201-006

**Features**

- Lead-free and RoHS compliant option available. Please see the device and ratings specifications table for more information
- High energy absorption capability  $W_{TM}$  40J to 530J (2ms)
- High pulse life rating
- High peak pulse current capability  $I_{TM}$  3500A to 9000A (8/20 $\mu$ s)
- Wide operating voltage range  $V_{M(AC)RMS}$  130V to 680V
- Available in tape and reel for automatic insertion; Also available with crimped and/or trimmed lead styles
- No derating up to 85°C ambient
- The C-III Series is supplied in 10mm, 14mm and 20mm disc versions with various lead options

C-III Series

**Absolute Maximum Ratings**

• For ratings of individual members of a series, see Device Ratings and Specifications chart

Continuous	C-III Series	Units
Steady State Applied Voltage:		
DC Voltage Range ( $V_{M(AC)RMS}$ )	130 to 660	V
Transients:		
Single-Pulse Peak Current ( $I_{TM}$ ) 8/20 $\mu$ s Wave (See Peak Pulse Current Test Waveform)	3500 to 9000	A
Single-Pulse Energy Range ( $W_{TM}$ ) 2ms Rectangular Wave	40 to 530	J
Operating Ambient Temperature Range ( $T_A$ )	-55 to +85	°C
Storage Temperature Range ( $T_{STG}$ )	-55 to +125	°C
Temperature Coefficient (a%) of Clamping Voltage ( $V_C$ ) at Specified Test Current	<0.0	%/°C
Hi-Pot Encapsulation (COATING Isolation Voltage Capability)	5000	V
COATING Insulation Resistance	1000	M $\Omega$

*CAUTION: Stresses above those listed in "Absolute Maximum Ratings" may cause permanent damage to the device. This is a stress only rating and operation of the device at these or any other conditions above those indicated in the operational sections of this specification is not implied.*

### C-III Series Ratings

Lead-free and RoHS Compliant Models		Standard Models		Maximum Ratings (85 °C)			
Part Number	Branding	Part Number	Branding	Continuous	Transient		
				Maximum $V_{RMS}$ $V_{M(AC)}$	Withstanding Energy (2ms) $W_{TM}$ (J)	Peak Current (8/20 $\mu$ s)	
						$I_{TM1}$ 1 Pulse (A)	$I_{TM2}$ 2 Pulses (A)
V130LA5CP	P130L5C	V130LA5C	130L5C	130	40	3500	3000
V130LA10CP	P130L10C	V130LA10C	130L10C	130	80	6000	5000
V130LA20CP	P130L20C	V130LA20C	130L20C	130	200	9000	7000
V130LA20CPX325	P130X325	V130LA20CX325	130CX325	130	200	9000	7000
V140LA5CP	P140L5C	V140LA5C	140L5C	140	45	3500	3000
V140LA10CP	P140L10C	V140LA10C	140L10C	140	90	6000	5000
V140LA20CP	P140L20C	V140LA20C	140L20C	140	210	9000	7000
V140LA20CPX340	P140X340	V140LA20CX340	140CX340	140	210	9000	7000
V150LA5CP	P150L5C	V150LA5C	150L5C	150	50	3500	3000
V150LA10CP	P150L10C	V150LA10C	150L10C	150	100	6000	5000
V150LA20CP	P150L20C	V150LA20C	150L20C	150	215	9000	7000
V150LA20CPX360	P150X360	V150LA20CX360	150CX360	150	215	9000	7000
V175LA5CP	P175L5C	V175LA5C	175L5C	175	55	3500	3000
V175LA10CP	P175L10C	V175LA10C	175L10C	175	110	6000	5000
V175LA20CP	P175L20C	V175LA20C	175L20C	175	220	9000	7000
V175LA20CPX425	P175X425	V175LA20CX425	175CX425	175	220	9000	7000
V230LA10CP	P230L10C	V230LA10C	230L10C	230	60	3500	3000
V230LA20CP	P230L20C	V230LA20C	230L20C	230	125	6000	5000
V230LA40CP	P230L40C	V230LA40C	230L40C	230	280	9000	7000
V230LA40CPX570	P230X570	V230LA40CX570	230X570	230	280	9000	7000
V250LA10CP	P250L10C	V250LA10C	250L10C	250	65	3500	3000
V250LA20CP	P250L20C	V250LA20C	250L20C	250	135	6000	5000
V250LA40CP	P250L40C	V250LA40C	250L40C	250	300	9000	7000
V250LA40CPX620	P250X620	V250LA40CX620	250CX620	250	300	9000	7000
V275LA10CP	P275L10C	V275LA10C	275L10C	275	70	3500	3000
V275LA20CP	P275L20C	V275LA20C	275L20C	275	145	6000	5000
V275LA40CP	P275L40C	V275LA40C	275L40C	275	320	9000	7000
V275LA40CPX680	P275X680	V275LA40CX680	275CX680	275	320	9000	7000
V300LA10CP	P300L10C	V300LA10C	300L10C	300	75	3500	3000
V300LA20CP	P300L20C	V300LA20C	300L20C	300	155	6000	5000
V300LA40CP	P300L40C	V300LA40C	300L40C	300	335	9000	7000
V300LA40CPX745	P300X745	V300LA40CX745	300CX745	300	335	9000	7000
V320LA10CP	P320L10C	V320LA10C	320L10C	320	80	3500	3000
V320LA20CP	P320L20C	V320LA20C	320L20C	320	165	6000	5000
V320LA40CP	P320L40C	V320LA40C	320L40C	320	345	9000	7000
V320LA40CPX810	P320X810	V320LA40CX810	320CX810	320	345	9000	7000
V385LA20CP	P385L20C	V385LA20C	385L20C	385	175	6000	5000
V385LA40CP	P385L40C	V385LA40C	385L40C	385	370	9000	7000
V420LA20CP	P420L20C	V420LA20C	420L20C	420	185	6000	5000
V420LA40CP	P420L40C	V420LA40C	420L40C	420	390	9000	7000
V460LA10CP	P460L10C	V460LA10C	460L10C	460	95	3500	3000
V460LA20CP	P460L20C	V460LA20C	460L20C	460	190	6000	5000
V460LA40CP	P460L40C	V460LA40C	460L40C	460	430	9000	7000
V480LA80CP	P480L80C	V480LA80C	480L80C	480	420	9000	7000
V510LA80CP	P510L80C	V510LA80C	510L80C	510	440	9000	7000
V550LA80CP	P550L80C	V550LA80C	550L80C	550	450	9000	7000
V575LA80CP	P575L80C	V575LA80C	575L80C	575	460	9000	7000
V625LA80CP	P625L80C	V625LA80C	625L80C	625	490	9000	7000
V660LA80CP	P660L80C	V660LA80C	660L80C	660	510	9000	7000
V680LA100CP	P680L100C	V680LA100C	680L100C	680	520	9000	7000



### C-III Series Specifications

Lead-free And RoHS Compliant Models	Standard Models	Model Size Disc Diameter (mm)	Specifications (25 °C)					
			Varistor Voltage at 1mA DC Test Current		Maximum Clamping Voltage (8/20µs)		Duty Cycle Surge Rating	
			V <sub>N</sub> Min (V)	V <sub>N</sub> Max (V)	V <sub>C</sub> (V)	I <sub>b</sub> (A)	3kA (8/20µs) # Pulses	750A (8/20µs) # Pulses
Part Number	Part Number							
V130LA5CP	V130LA5C	10	184	228	340	25	2	100
V130LA10CP	V130LA10C	14	184	228	340	50	40	600
V130LA20CP	V130LA20C	20	184	228	340	100	80	1600
V130LA20CPX325	V130LA20CX325	20	184	220	325	100	80	1600
V140LA5CP	V140LA5C	10	198	242	360	25	2	100
V140LA10CP	V140LA10C	14	198	242	360	50	40	600
V140LA20CP	V140LA20C	20	198	242	360	100	80	1600
V140LA20CPX340	V140LA20CX340	20	198	230	340	100	80	1600
V150LA5CP	V150LA5C	10	212	268	395	25	2	100
V150LA10CP	V150LA10C	14	212	268	395	50	40	600
V150LA20CP	V150LA20C	20	212	268	395	100	80	1600
V150LA20CPX360	V150LA20CX360	20	212	243	360	100	80	1600
V175LA5CP	V175LA5C	10	247	303	455	25	2	100
V175LA10CP	V175LA10C	14	247	303	455	50	40	600
V175LA20CP	V175LA20C	20	247	303	455	100	80	1600
V175LA20CPX425	V175LA20CX425	20	247	285	425	100	80	1600
V230LA10CP	V230LA10C	10	324	396	595	25	2	100
V230LA20CP	V230LA20C	14	324	396	595	50	40	600
V230LA40CP	V230LA40C	20	324	396	595	100	80	1600
V230LA40CPX570	V230LA40CX570	20	324	384	570	100	80	1600
V250LA10CP	V250LA10C	10	354	429	650	25	2	100
V250LA20CP	V250LA20C	14	354	429	650	50	40	600
V250LA40CP	V250LA40C	20	354	429	650	100	80	600
V250LA40CPX620	V250LA40CX620	20	354	413	620	100	80	1600
V275LA10CP	V275LA10C	10	389	473	710	25	2	100
V275LA20CP	V275LA20C	14	389	473	710	50	40	600
V275LA40CP	V275LA40C	20	389	473	710	100	80	1600
V275LA40CPX680	V275LA40CX680	20	389	453	680	100	80	1600
V300LA10CP	V300LA10C	10	420	517	775	25	2	100
V300LA20CP	V300LA20C	14	420	517	775	50	40	600
V300LA40CP	V300LA40C	20	420	517	775	100	80	1600
V300LA40CPX745	V300LA40CX745	20	420	490	745	100	80	1600
V320LA10CP	V320LA10C	10	462	565	850	25	2	100
V320LA20CP	V320LA20C	14	462	565	850	50	40	600
V320LA40CP	V320LA40C	20	462	565	850	100	80	1600
V320LA40CPX810	V320LA40CX810	20	462	540	810	100	80	1600
V385LA20CP	V385LA20C	14	558	682	1025	50	40	600
V385LA40CP	V385LA40C	20	558	682	1025	100	80	1600
V420LA20CP	V420LA20C	14	610	748	1120	50	40	600
V420LA40CP	V420LA40C	20	610	748	1120	100	80	1600
V460LA10CP	V460L10C	10	640	790	1190	25	2	100
V460LA20CP	V460L20C	14	640	790	1190	50	40	600
V460LA40CP	V460LA40C	20	640	790	1190	100	80	1600
V480LA80CP	V480LA80C	20	670	825	1240	100	80	1600
V510LA80CP	V510LA80C	20	735	910	1350	100	80	1600
V550LA80CP	V550LA80C	20	780	970	1435	100	80	1600
V575LA80CP	V575LA80C	20	805	1000	1500	100	80	1600
V625LA80CP	V625LA80C	20	900	1100	1725	100	80	1600
V660LA80CP	V660LA80C	20	940	1210	1820	100	80	1600
V680LA100CP	V680LA100C	20	990	1130	1700	100	80	1600

1 Average power dissipation of transients not to exceed 0.6W and 1W for model sizes 14mm and 20mm, respectively.

2 7mm parts also available-contact factory for further information

3 For additional or intermediary voltage ratings contact factory

©2009 Littelfuse, Inc.

Specifications are subject to change without notice.

Please refer to [www.littelfuse.com/series/c-iii.html](http://www.littelfuse.com/series/c-iii.html) for current information.

### Power Dissipation Ratings

Should transients occur in rapid succession, the average power dissipation is the energy (watt-seconds) per pulse times the number of pulses per second. The power so developed must be within the specifications shown on the Device Ratings and Specifications Table for the specific device. The operating values of a MOV need to be derated at high temperatures as shown above. Because varistors only dissipate a relatively small amount of average power they are not suitable for repetitive applications that involve substantial amounts of average power dissipation.

### Current Energy and Power Derating Curve

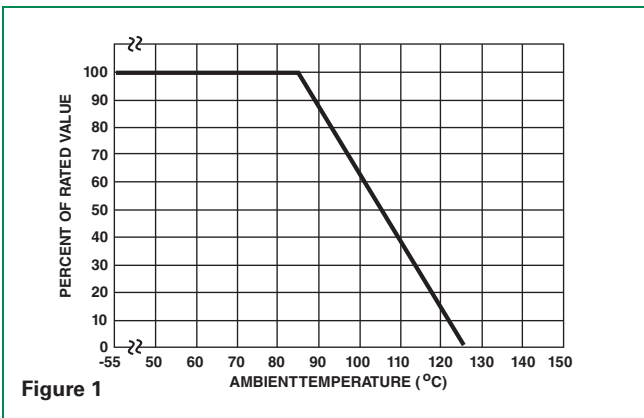


Figure 1

### Transient V-I Characteristics Curves

### Maximum Clamping Voltage for 10mm Parts

V130LA5C(P) – V460LA10C(P)

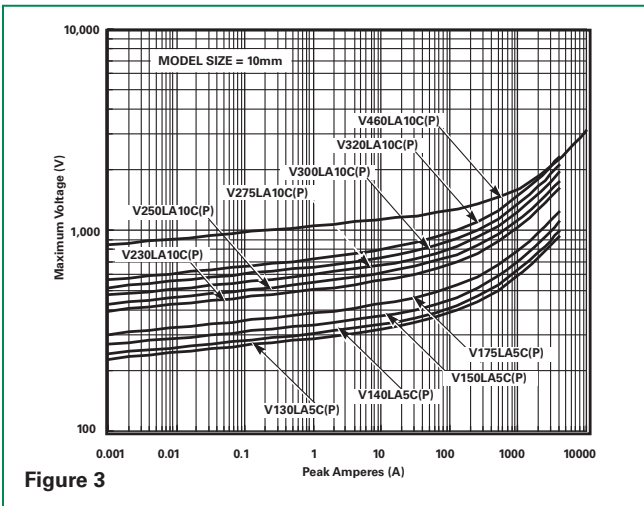


Figure 3

### Peak Pulse Current Test Waveform

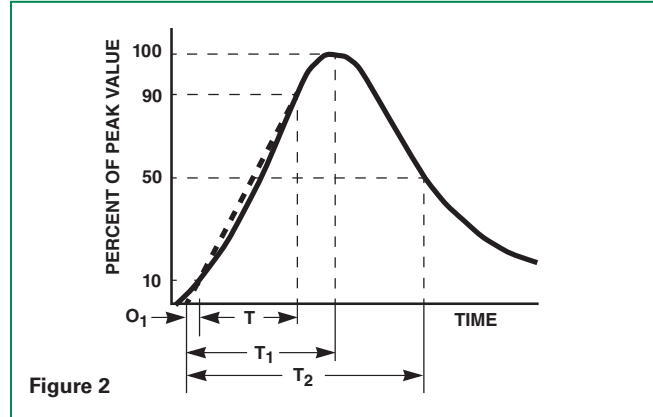


Figure 2

$O_1$  = Virtual Origin of Wave  
 $T$  = Time from 10% to 90% of Peak  
 $T_1$  = Rise Time =  $1.25 \times T$   
 $T_2$  = Decay Time

**Example** - For an  $8/20 \mu s$  Current Waveform:

$8 \mu s = T_1$  = Rise Time  
 $20 \mu s = T_2$  = Decay Time

### Pulse Rating Curves

### Repetitive Surge Capability for 10mm Parts

V130LA5C(P)-V320LA10C(P)

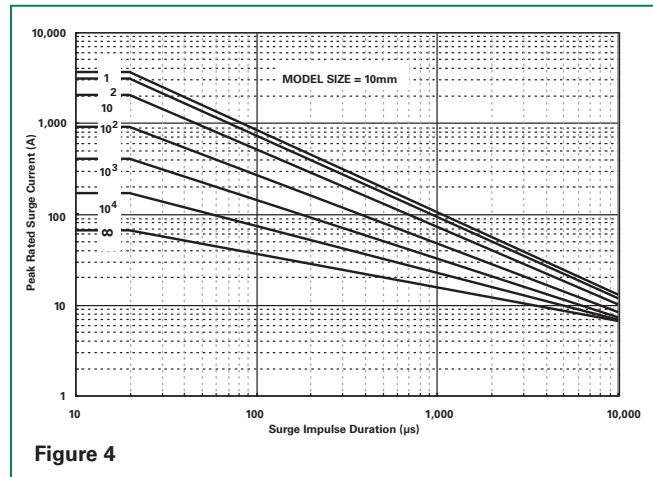


Figure 4

**Transient V-I Characteristics Curves (continued)**

**Maximum Clamping Voltage for 14mm Parts**

V130LA10C(P) – V420LA20C(P)

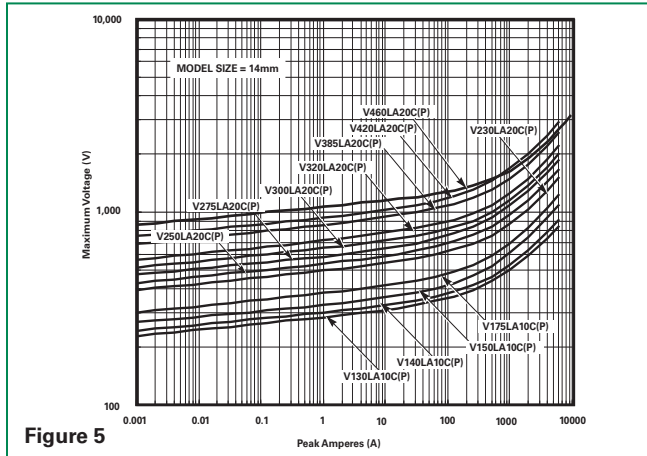


Figure 5

**Pulse Rating Curves**

**Repetitive Surge Capability for 14mm Parts**

V130LA10C(P)-V420LA20C(P)

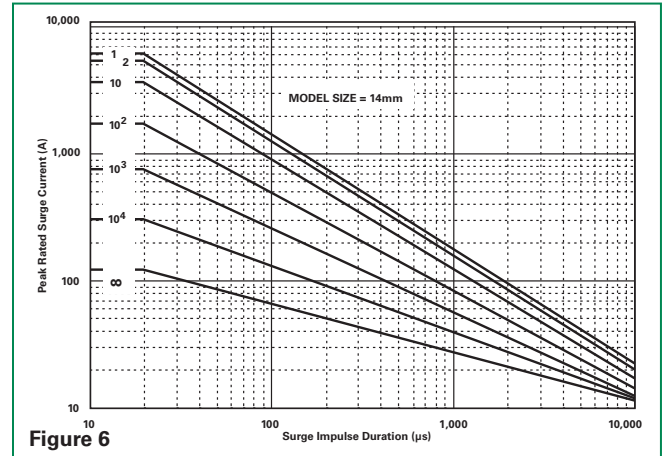


Figure 6

**Maximum Clamping Voltage for 20mm Parts**

V130LA5C(P) - V320LA10C (P)

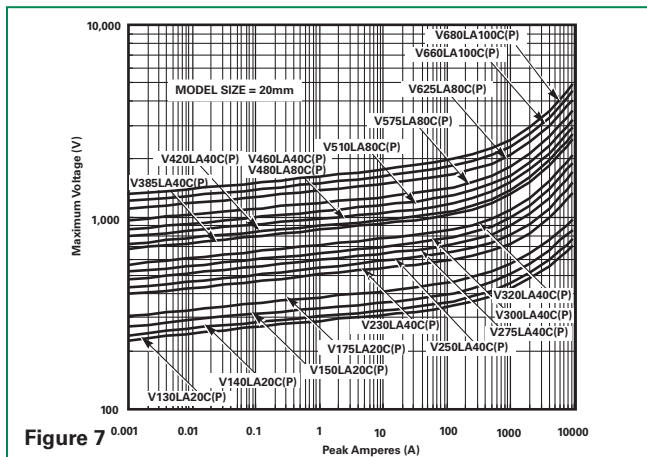


Figure 7

**Repetitive Surge Capability for 20mm Parts**

V130LA20C(P)-V680LA100C(P)

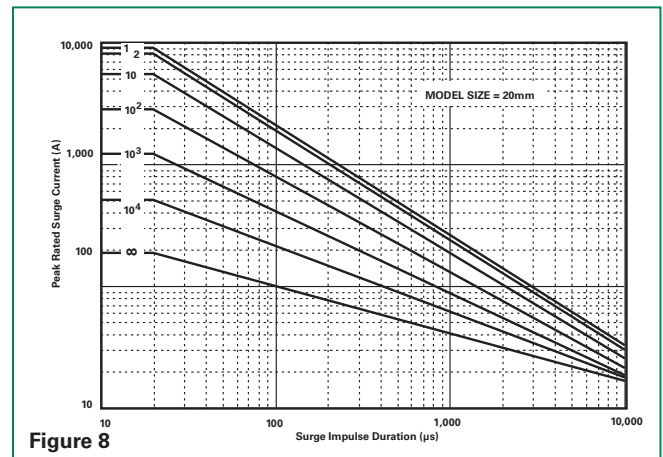


Figure 8

**Maximum Clamping Voltage for Low Clamping Voltage Parts**

V130LA20CX325(P) - V300LA40CX245 (P)

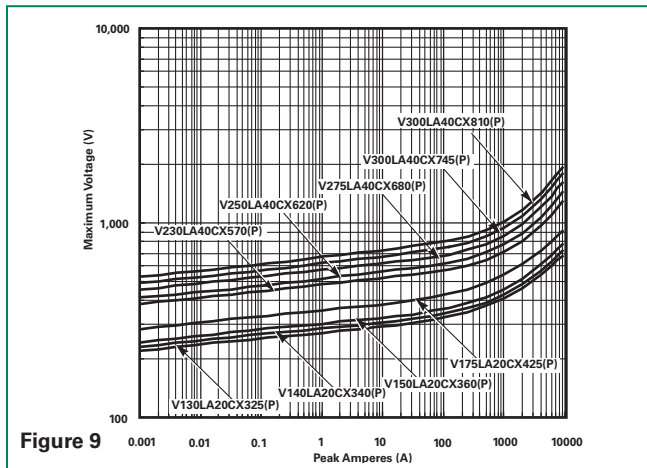


Figure 9

C-III Series

### Wave Solder Profile

### Non Lead-free Profile

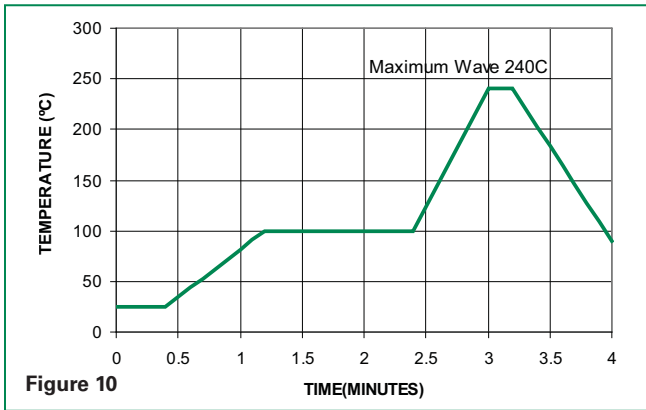


Figure 10

### Lead-free Profile

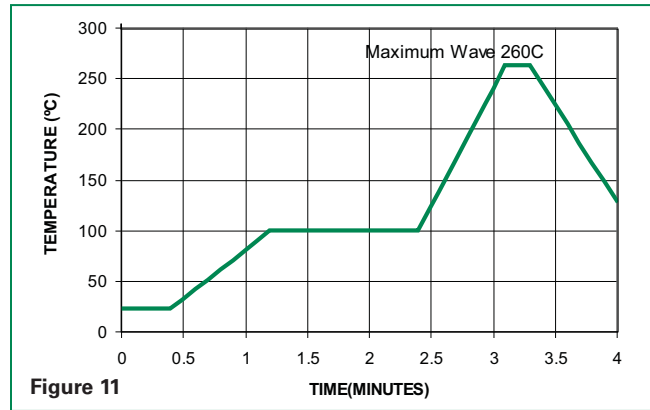


Figure 11

### Physical Specifications

<b>Lead Material</b>	Tin-Coated Copper Wire
<b>Soldering Characteristics</b>	Solderability per MIL-STD-202, Method 208E
<b>Insulating Material</b>	Cured, flame retardant epoxy polymer meets UL94V-0 requirements
<b>Device Labeling</b>	Marked with LF, voltage, UL/CSA Logos, and date code

### Environmental Specifications

<b>Operating/Storage Temperature</b>	-55°C to +85°C/-55°C to +125°C
<b>Humidity Aging</b>	+85°C, 85% RH, 1000 hours +/-10% typical voltage change
	+85°C to -40°C 10 times +/-10% typical voltage change
<b>Solvent Resistance</b>	MIL-STD-202, Method 215F
<b>Moisture Sensitivity</b>	Level 1, J-STD-020C

### C-III Series Varistors for Hi-Temperature Operating Conditions:

- Phenolic Coated CIII Series devices are available with improved maximum operating maximum temperature 125°C
- These devices also have improved temperature cycling performance capability.
- Ratings and Specifications are as per standard CIII Series except Hi-Pot Encapsulation (Isolation Voltage Capability)=500V.
- To order: add X1347 to part number (e.g. V230LA40CX1347)
- These devices are not UL, CSA, VDE or CECC certified.
- Contact factory for further details.

### AC Bias Reliability

The C-III Series MOVs were designed for use on the AC line. The varistor is connected across the AC line and is biased with a constant amplitude sinusoidal voltage. It should be noted that the definition of failure is a shift in the nominal varistor voltage ( $V_N$ ) exceeding +/-10%. Although this type of varistor is still functioning normally after this magnitude of shift, devices at the lower extremities of  $V_N$  tolerance will begin to dissipate more power.

Because of this possibility, an extensive series of statistically designed tests were performed to determine the reliability of the C-III type of varistor under AC bias combined with high levels of temperature stress. To date, this test has generated over 50,000 device hours of operation at a temperature of 125°C, although only rated at 85°C. Changes in the nominal varistor voltage, measured at 1mA, of less than 2% have been recorded, as displayed in the diagram at right.

### High Temperature Operating Life 125°C for 1000 Hours at Rated Bias

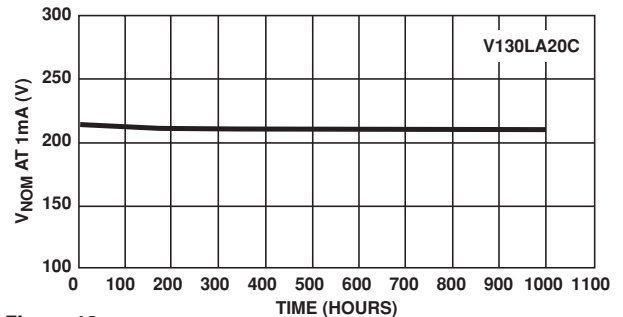


Figure 12

### Transient Surge Current/Energy Transient Capability

The transient surge rating serves as an excellent figure of merit for the C-III varistor. This inherent surge handling capability is one of the C-III varistor's best features.

The enhanced surge absorption capability results from improved process uniformity and enhanced construction. The homogeneity of the raw material powder and improved control over the sintering and assembly processes are contributing factors to this improvement.

In the low power AC mains environment, industry standards (UL, IEC, NEMA and IEEE) all suggest that the worst case surge occurrence will be 3kA. Such a transient event may occur up to five times over the equipment life time (approximately 10 years). While the occurrences of five 3kA transients is the required capability, the rated, repetitive surge current for the C-III Series is 80 pulses for the 20mm units and 40 pulses for the 14mm Series.

As a measure of the inherent device capability, samples of the 20mm V130LA20C devices were subjected to a worst case repetitive transient surges test. After 100 pulses, each of 3kA, there was negligible change in the device characteristics. Changes in the clamping voltage, measured at 100A, of less than 3% were recorded, as shown in the upper diagram at right.

Samples of the 14mm Series V175LA20C were subjected to repetitive surge occurrences of 750A. Again, there was negligible changes in any of the device characteristics after 2000 pulses, as shown in the lower diagram at right.

In both cases the inherent device capability is far in excess of the expected worst case scenario.

### Typical Repetitive Surge Current Capability of C-III Series MOVs

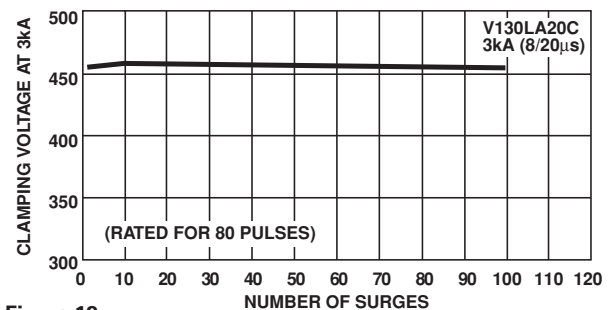


Figure 13

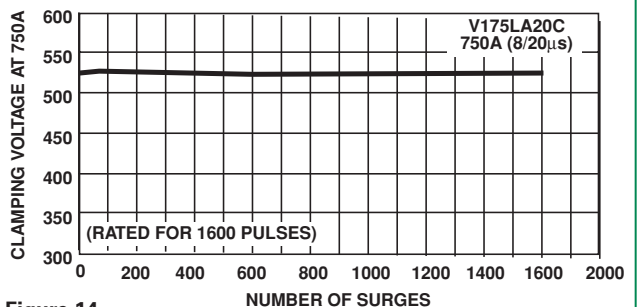
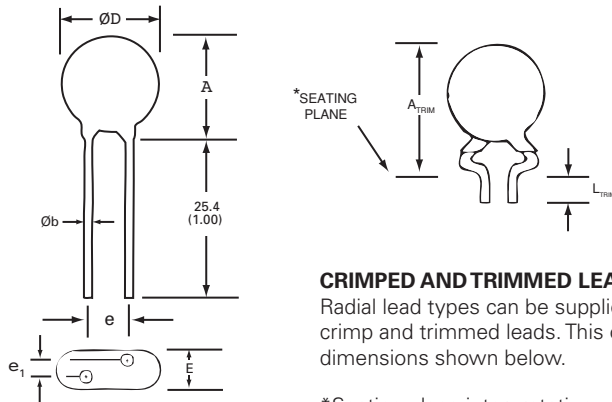


Figure 14

### Product Dimensions (mm)



#### CRIMPED AND TRIMMED LEADS

Radial lead types can be supplied with combination preformed crimp and trimmed leads. This option is supplied to the dimensions shown below.

\*Seating plane interpretation per IEC-60717

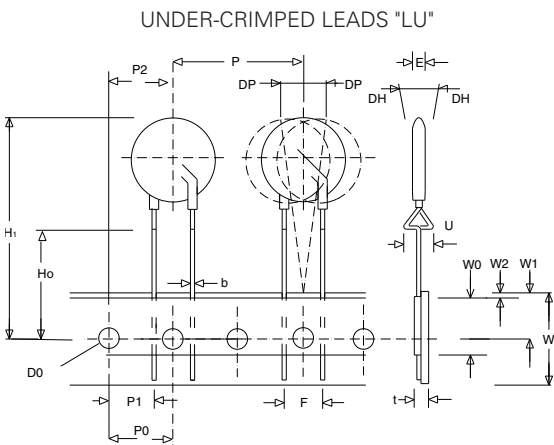
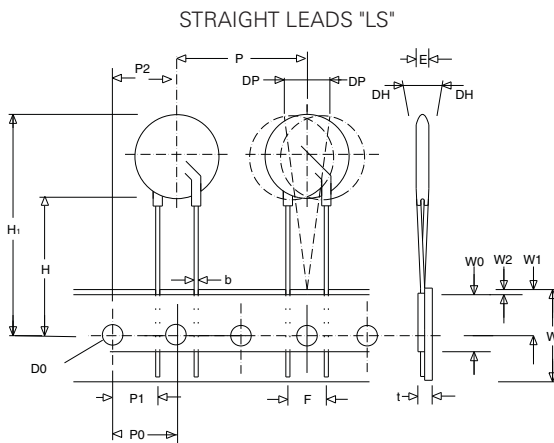
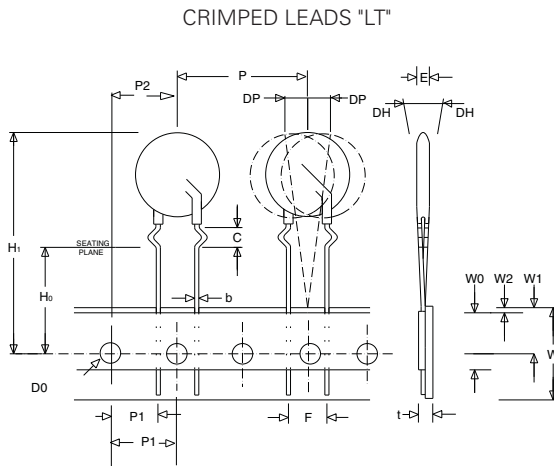
Dimension	V <sub>RMS</sub> Voltage Model	10mm Size		14mm Size		20mm Size	
		Min.	Max.	Min.	Max.	Min.	Max.
<b>A</b>	All	12.0 (0.472)	16.0 (0.630)	13.5 (0.531)	20.0 (0.787)	17.5 (0.689)	28.0 (1.102)
<b>ØD</b>	All	10.0 (0.394)	12.5 (0.492)	13.5 (0.531)	17.0 (0.669)	17.5 (0.689)	23.0 (0.906)
<b>e</b>	All	6.5 (0.256)	8.5 (0.335)	6.5 (0.256)	8.5 (0.335)	6.5 (0.256)	8.5 (0.335)
<b>e<sub>1</sub></b>	130 - 320	2.5 (0.098)	5.5 (0.216)	2.5 (0.098)	5.5 (0.216)	2.5 (0.098)	5.5 (0.216)
	>320			4.5 (0.177)	9.0 (0.354)	4.5 (0.177)	9.0 (0.354)
<b>E</b>	130 - 320	-	7.3 (0.287)	-	7.3 (0.287)	-	7.3 (0.287)
	>320				11.0 (0.433)		11.0 (0.433)
<b>Øb</b>	130 - 320	0.76 (0.030)	0.86 (0.034)	0.76 (0.030)	0.86 (0.034)	0.76 (0.030)	0.86 (0.034)
	>660					0.95 (0.037)	1.05 (0.041)
<b>A<sub>TRIM</sub></b>	All	-	19.5 (0.768)	-	23.5 (0.925)	-	30.0 (1.18)
<b>L<sub>TRIM</sub></b>	All	2.41 (0.095)	4.69 (0.185)	2.41 (0.095)	4.69 (0.185)	2.41 (0.095)	4.69 (0.185)

Dimensions are in millimeters (inches)

- 10mm lead spacing also available. See additional lead style options.
- 7mm and 12mm devices also available upon request. Contact factory for details.

**Tape and Reel Specifications**

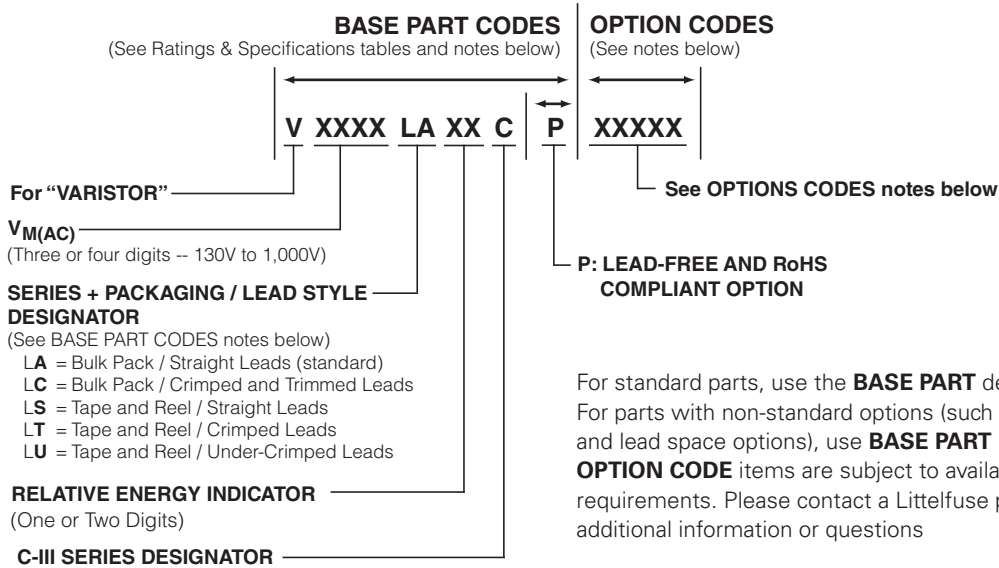
- (available for voltage ratings up to 320V only)



Symbol	Description	Model Size		
		10mm	14mm	20mm
<b>P</b>	Pitch of Component	25.4 -/+1.0		
<b>P<sub>0</sub></b>	Feed Hole Pitch	12.7 -/+ 0.2		
<b>P<sub>1</sub></b>	Feed Hole Center to Pitch	8.85 -/+ 0.8		
<b>P<sub>2</sub></b>	Hole Center to Component Center	12.7 -/+ 0.7		
<b>F</b>	Lead to Lead Distance	7.50 -/+ 0.8		
<b>h</b>	Component Alignment	2.00 Max		
<b>W</b>	Tape Width	18.25 -/+ 0.75		
<b>W<sub>0</sub></b>	Hold Down Tape Width	12.0 -/+ 0.3		
<b>W<sub>1</sub></b>	Hole Position	9.125 -/+ 0.625		
<b>W<sub>2</sub></b>	Hold Down Tape Position	0.5 Max		
<b>H</b>	Height From Tape Center To Component Base	19.0 -/+1.0		
<b>H<sub>0</sub></b>	Seating Plane Height	16.0 -/+ 0.5		
<b>H<sub>1</sub></b>	Component Height	36 Max	40 Max	46.5 Max
<b>D<sub>0</sub></b>	Feed Hole Diameter	4.0 -/+ 0.2		
<b>t</b>	Total Tape Thickness	0.7 -/+ 0.2		
<b>p</b>	Component Alignment	3° Max		
<b>U</b>	Under crimp Width	8.0 Max		



### Part Numbering System



For standard parts, use the **BASE PART** designator only.  
 For parts with non-standard options (such as additional form, packaging and lead space options), use **BASE PART + OPTION CODE**.  
**OPTION CODE** items are subject to availability and minimum order requirements. Please contact a Littelfuse products representative for additional information or questions

### Ordering Notes:

#### BASE PART CODES:

##### Series + Packaging / Lead Style Designators:

Ordering examples:

Straight Lead Bulk Pack (standard)	Straight Lead Tape & Reel	Crimped Lead Tape & Reel	Crimped & Trimmed Lead Bulk Pack	Under-Crimp Lead Tape & Reel
V130LA20C	V130LS20C	V130LT20C	V130LC20C	V130LU20C

Crimped leads are standard on LA Series varistors supplied in tape and reel, denoted with "LT."

"LC" style is supplied in bulk only.

"LU" style is supplied in tape & reel only.

For crimped leads without trimming and any variations other than that described above, please contact Littelfuse.

##### Lead-free / RoHS Designator:

For Lead-free and RoHS compliant parts add "P" after the **BASE PART** number and before any other **OPTION CODE**:

Standard Model	Order As
V130LA20C	V130LA20CP

Standard Model with Option	Order As
V420LA20CX1347	V420LA20CPX1347

#### OPTION CODES:

##### X10: 10MM LEAD SPACING OPTION --

For 10 (-/+1)mm lead spacing (available on 20mm diameter models only), append standard model BASE PART number with "X10." Example:

Standard Model	Order As
V130LA20C	V130LA20CX10

##### X2855: Nickel Barrier COATED WIRE OPTION --

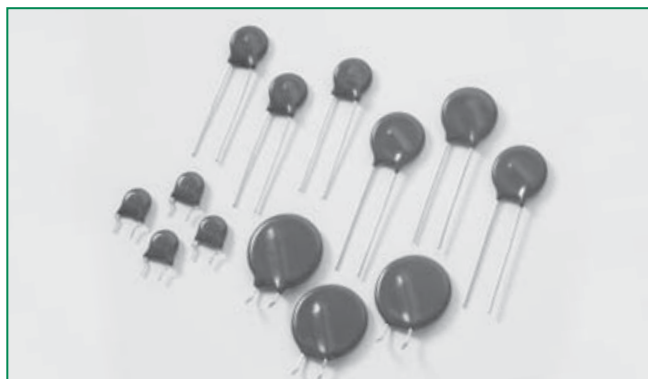
All standard parts use Tin-Coated Copper wire. Nickel Barrier Coated wire is available as an option, consisting of Copper wire with a flashing of Nickel followed by a top coating of Tin. To order append standard model BASE PART number with "X2855." Example:

Standard Model	Order As
V130LA20C	V130LA20CX2855

Littelfuse C-III Series varistors are shipped standard in bulk pack with straight leads and lead spacing outlined in the Package Dimensions section of this data sheet. Contact a Littelfuse representative to discuss non-standard options.

#### TAPE & REEL QUANTITIES:





Device Size	Voltage	Quantity Per Reel		
		"T" Reel	"S" Reel	"U" Reel
10mm	ALL	500	500	500
14mm	≤ 275V	500	500	500
	≥ 275V	400	400	400
20mm	≤ 275V	500	500	500
	≥ 275V	400	400	400

**RoHS**  **LA Varistor Series**

**Description**

The LA Series of transient voltage surge suppressors are radial leaded varistors (MOVs) that are designed to be operated continuously across AC power lines. These UL recognized varistors require very little mounting space, and are offered in various standard lead form options.

The LA Series varistors are available in four model sizes: 7mm, 10mm, 14mm and 20mm; and have a  $V_{M(AC)RMS}$  voltage range from 130V to 1000V, and an energy absorption capability up to 360J. Some LA Series model numbers are available with clamping voltage selections, designated by a model number suffix of either A or B. The 'A' selection is the standard model; the 'B' selection provides a lower clamping voltage. See LA Series Device Ratings and Specifications Table for part number and brand information.

**Agency Approvals**

Agency	Agency File Number
	E320116, E56529, E135010
	116895E
	LR91788
	42201-006

**Features**

- Lead-free and RoHS compliant option available. Please see the device and ratings specifications table for more information.
- Energy absorption capability ( $W_{TM}$ ) up to 360J
- Wide operating voltage range  $V_{M(AC)RMS}$  130V to 1000V
- No derating up to 85°C ambient
- Available in tape and reel or bulk pack

**Absolute Maximum Ratings**

• For ratings of individual members of a series, see Device Ratings and Specifications chart

Continuous	LA Series	Units
<b>Steady State Applied Voltage:</b>		
AC Voltage Range ( $V_{M(AC)RMS}$ )	130 to 1000	V
DC Voltage Range ( $V_{M(DC)}$ )	175 to 1200	V
<b>Transients:</b>		
Peak Pulse Current ( $I_{TM}$ )		
For 8/20 $\mu$ s Current Wave (See Figure 2)	1200 to 6500	A
Single Pulse Energy Range		
For 10/1000 $\mu$ s Current Wave ( $W_{TM}$ )	11 to 360	J
Operating Ambient Temperature Range ( $T_A$ )	-55 to +85	°C
Storage Temperature Range ( $T_{STG}$ )	-55 to +125	°C
Temperature Coefficient ( $\alpha_V$ ) of Clamping Voltage ( $V_C$ ) at Specified Test Current	<0.01	%/°C
Hi-Pot Encapsulation (COATING Isolation Voltage Capability) (Dielectric must withstand indicated DC voltage for one minute per MIL-STD 202, Method 301)	2500	V
COATING Insulation Resistance	1000	M $\Omega$

**CAUTION:** Stresses above those listed in "Absolute Maximum Ratings" may cause permanent damage to the device. This is a stress only rating and operation of the device at these or any other conditions above those indicated in the operational sections of this specification is not implied.

### LA Series Ratings & Specifications

Lead-free and RoHS Compliant Models		Standard Models		Model Size Disc Dia. (mm)	Maximum Rating (85°C)				Specifications (25°C)				
					Continuous		Transient		Varistor Voltage at 1mA DC Test Current		Maximum Clamping Voltage 8 x 20 μs		Typical Capacitance f = 1MHz
Part Number	Branding	Part Number	Branding	V <sub>RMS</sub>	V <sub>DC</sub>	Energy 10 x 1000 μs	Peak Current 8 x 20 μs	V <sub>NOM Min</sub>					
				V <sub>M(AC)</sub> (V)	V <sub>M(DC)</sub> (V)	W <sub>TM</sub> (J)	I <sub>TM</sub> (A)	(V)	(V)	(V)	(A)	(pF)	
V130LA1P	P1301	V130LA1	1301	7	130	175	11	1200	184	255	390	10	180
V130LA2P	P1302	V130LA2	1302	7	130	175	11	1200	184	228	340	10	180
V130LA5P	P1305	V130LA5	1305	10	130	175	20	2500	184	228	340	25	450
V130LA10AP	P130L10	V130LA10A	130L10	14	130	175	38	4500	184	228	340	50	1000
V130LA20AP	P130L20	V130LA20A	130L20	20	130	175	70	6500	184	228	340	100	1900
V130LA20BP	P130L20B	V130LA20B	130L20B	20	130	175	70	6500	184	220	325	100	1900
V140LA2P	P1402	V140LA2	1402	7	140	180	12	1200	198	242	360	10	160
V140LA5P	P1405	V140LA5	1405	10	140	180	22	2500	198	242	360	25	400
V140LA10AP	P140L10	V140LA10A	140L10	14	140	180	42	4500	198	242	360	50	900
V140LA20AP	P140L20	V140LA20A	140L20	20	140	180	75	6500	198	242	340	100	1750
V150LA1P	P1501	V150LA1	1501	7	150	200	13	1200	212	284	430	10	150
V150LA2P	P1502	V150LA2	1502	7	150	200	13	1200	212	268	395	10	150
V150LA5P	P1505	V150LA5	1505	10	150	200	25	2500	212	268	395	25	360
V150LA10AP	P150L10	V150LA10A	150L10	14	150	200	45	4500	212	268	395	50	800
V150LA20AP	P150L20	V150LA20A	150L20	20	150	200	80	6500	212	268	395	100	1600
V150LA20BP	P150L20B	V150LA20B	150L20B	20	150	200	80	6500	212	243	360	100	1600
V175LA2P	P1752	V175LA2	1752	7	175	225	15	1200	247	303	455	10	130
V175LA5P	P1755	V175LA5	1755	10	175	225	30	2500	247	303	455	25	350
V175LA10AP	P175L10	V175LA10A	175L10	14	175	225	55	4500	247	303	455	50	700
V175LA20AP	P175L20	V175LA20A	175L20	20	175	225	90	6500	247	303	455	100	1400
V230LA4P	P2304	V230LA4	2304	7	230	300	20	1200	324	396	595	10	100
V230LA10P	P230L	V230LA10	230L	10	230	300	35	2500	324	396	595	25	250
V230LA20AP	P230L20	V230LA20A	230L20	14	230	300	70	4500	324	396	595	50	550
V230LA40AP	P230L40	V230LA40A	230L40	20	230	300	122	6500	324	396	595	100	1100
V250LA2P	P2502	V250LA2	2502	7	250	330	21	1200	354	473	730	10	90
V250LA4P	P2504	V250LA4	2504	7	250	330	21	1200	354	429	650	10	90
V250LA10P	P250L	V250LA10	250L	10	250	330	40	2500	354	429	650	25	220
V250LA20AP	P250L20	V250LA20A	250L20	14	250	330	72	4500	354	429	650	50	500
V250LA40AP	P250L40	V250LA40A	250L40	20	250	330	130	6500	354	429	650	100	1000
V250LA40BP	P250L40B	V250LA40B	250L40B	20	250	330	130	6500	354	413	620	100	1000
V275LA2P	P2752	V275LA2	2752	7	275	369	23	1200	389	515	775	10	80
V275LA4P	P2754	V275LA4	2754	7	275	369	23	1200	389	473	710	10	80
V275LA10P	P275L	V275LA10	275L	10	275	369	45	2500	389	473	710	25	200
V275LA20AP	P275L20	V275LA20A	275L20	14	275	369	75	4500	389	473	710	50	450
V275LA40AP	P275L40	V275LA40A	275L40	20	275	369	140	6500	389	473	710	100	900
V275LA40BP	P275L40B	V275LA40B	275L40B	20	275	369	140	6500	389	453	680	100	900
V300LA2P	P3002	V300LA2	3002	7	300	405	25	1200	420	565	870	10	70
V300LA4P	P3004	V300LA4	3004	7	300	405	25	1200	420	517	775	10	70
V300LA10P	P300L	V300LA10	300L	10	300	405	46	2500	420	517	775	25	180
V300LA20AP	P300L20	V300LA20A	300L20	14	300	405	77	4500	420	517	775	50	400
V300LA40AP	P300L40	V300LA40A	300L40	20	300	405	165	6500	420	517	775	100	800
V320LA7P	P3207	V320LA7	3207	7	320	420	25	1200	462	565	850	10	65
V320LA10P	P320L	V320LA10	320L	10	320	420	48	2500	462	565	850	25	170
V320LA20AP	P320L20	V320LA20A	320L20	14	320	420	80	4500	462	565	850	50	380
V320LA40BP	P320L40	V320LA40B	320L40	20	320	420	150	6500	462	540	810	100	750
V385LA7P	P3857	V385LA7	3857	7	385	505	27	1200	558	682	1025	10	60
V385LA10P	P385L	V385LA10	385L	10	385	505	51	2500	558	682	1025	25	160
V385LA20AP	P385L20	V385LA20A	385L20	14	385	505	85	4500	558	682	1025	50	360

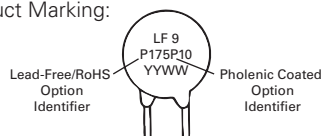
### LA Series Ratings & Specifications (Continued...)

Lead-free and RoHS Compliant Models		Standard Models		Model Size Disc Dia. (mm)	Maximum Rating (85°C)				Specifications (25°C)				
					Continuous		Transient		Varistor Voltage at 1mA DC Test Current		Maximum Clamping Voltage 8 x 20 μs		Typical Capacitance f = 1MHz
Part Number	Branding	Part Number	Branding	V <sub>RMS</sub>	V <sub>DC</sub>	Energy 10 x 1000 μs	Peak Current 8 x 20 μs	V <sub>NOM Min</sub>					
				(V)	(V)	(J)	(A)	(V)	(V)	(V)	(A)	(pF)	
V385LA40BP	P385L40	V385LA40B	385L40	20	385	505	160	6500	558	682	1025	100	700
V420LA7P	P4207	V420LA7	4207	7	420	560	30	1200	610	748	1120	10	55
V420LA10P	P420L	V420LA10	420L	10	420	560	55	2500	610	748	1120	25	140
V420LA20AP	P420L20	V420LA20A	420L20	14	420	560	90	4500	610	748	1120	50	300
V420LA40BP	P420L40	V420LA40B	420L40	20	420	560	160	6500	610	720	1060	100	600
V460LA7P	P4607	V460LA7C	4607	7	460	615	37	1200	640	790	1190	10	55
V460LA10P	P460L	V460LA10	460L	10	460	615	56	2500	640	790	1190	25	120
V460LA20AP	P460L20	V460LA20A	460L20	14	460	615	100	4500	640	790	1190	50	280
V460LA40BP	P460L40	V460LA40B	460L40	20	460	615	170	6500	640	756	1110	100	560
V480LA7P	P4807	V480LA7	4807	7	480	640	35	1200	670	825	1240	10	50
V480LA10P	P480L	V480LA10	480L	10	480	640	60	2500	670	825	1240	25	120
V480LA40AP	P480L40	V480LA40A	480L40	14	480	640	105	4500	670	825	1240	50	270
V480LA80BP	P480L80	V480LA80B	480L80	20	480	640	180	6500	670	790	1160	100	550
V510LA10P	P510L	V510LA10	510L	10	510	675	63	2500	735	910	1350	25	100
V510LA40AP	P510L40	V510LA40A	510L40	14	510	675	110	4500	735	910	1350	50	250
V510LA80BP	P510L80	V510LA80B	510L80	20	510	675	190	6500	735	860	1280	100	500
V575LA10P	P575L	V575LA10	575L	10	575	730	65	2500	805	1000	1500	25	90
V575LA40AP	P575L40	V575LA40A	575L40	14	575	730	120	4500	805	1000	1500	50	220
V575LA80BP	P575L80	V575LA80B	575L80	20	575	730	220	6500	805	960	1410	100	450
V625LA10P	P625L	V625LA10	625L	10	625	825	67	2500	900	1100	1650	25	80
V625LA40AP	P625L40	V625LA40A	625L40	14	625	825	125	4500	900	1100	1650	50	210
V625LA80BP	P625L80	V625LA80B	625L80	20	625	825	230	6500	900	1100	1650	100	425
V680LA10P	P680L	V680LA10	680L	10	680	875	75	2500	990	1240	1875	25	65
V680LA80AP	P680L80	V680LA80A	680L80	14	680	875	145	4500	990	1240	1875	50	190
V680LA100BP	P680L100	V680LA100B	680L100	20	680	875	260	6500	990	1130	1700	100	380
V660LA10P	P660L	V660LA10	660L	10	660	850	70	2500	940	1210	1820	25	70
V660LA50AP	P660L50	V660LA50A	660L50	14	660	850	140	4500	940	1210	1820	50	200
V660LA100BP	P660L100	V660LA100B	660L100	20	660	850	250	6500	940	1100	1650	100	400
V1000LA80AP	P1000L8	V1000LA80A	1000L80	14	1000	1200	220	4500	1425	1800	2700	50	130
V1000LA160BP	P1000L16	V1000LA160B	1000L160	20	1000	1200	360	6500	1425	1600	2420	100	250

NOTE: Average power dissipation of transients not to exceed 0.25W, 0.4W, 0.6W or 1W for model sizes 7mm, 10mm, 14mm and 20mm, respectively.

### LA Series Varistors for Hi-Temperature Operating Conditions:

- Phenolic-coated LA Series devices are available with improved maximum operating maximum temperature 125°C.
- These devices also have improved temperature cycling performance capability.
- Ratings and Specifications are as per standard LA Series except Hi-Pot Encapsulation (Isolation Voltage Capability) = 500V.
- These devices are not UL, CSA, VDE or CECC certified.
- To order: add X1347 to end of part number (e.g. V230LA20AX**X1347** or V230LA20APX**X1347** for Lead Free/RoHS version)
- Product Marking:



### Power Dissipation Ratings

Should transients occur in rapid succession, the average power dissipation is the energy (watt-seconds) per pulse times the number of pulses per second. The power so developed must be within the specifications shown on the Device Ratings and Specifications Table for the specific device. The operating values of a MOV need to be derated at high temperatures as shown in the diagram below. Because varistors only dissipate a relatively small amount of average power they are not suitable for repetitive applications that involve substantial amounts of average power dissipation.

### Current Energy and Power Derating Curve

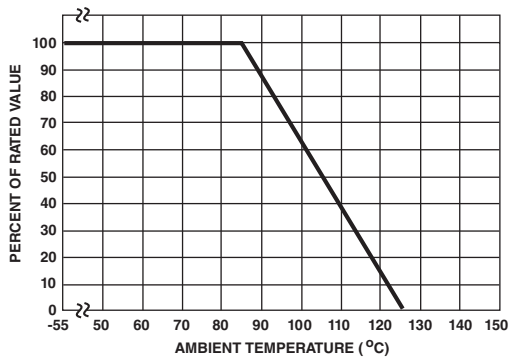


Figure 1

### Peak Pulse Current Test Waveform

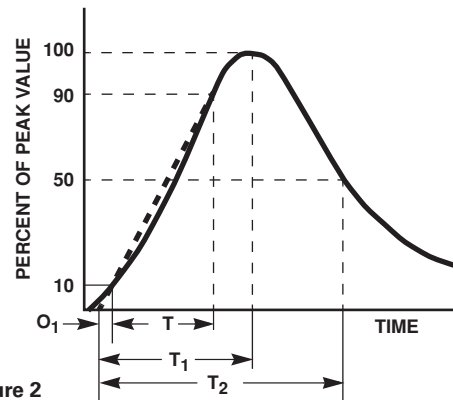


Figure 2

- $O_1$  = Virtual Origin of Wave
- $T$  = Time from 10% to 90% of Peak
- $T_1$  = Rise Time =  $1.25 \times T$
- $T_2$  = Decay Time

**Example** - For an 8/20  $\mu$ s Current Waveform:

- $8 \mu$ s =  $T_1$  = Rise Time
- $20 \mu$ s =  $T_2$  = Decay Time

**Transient V-I Characteristics Curves**

**Maximum Clamping Voltage for 7mm Parts**

V130LA1(P) - V300LA2(P)

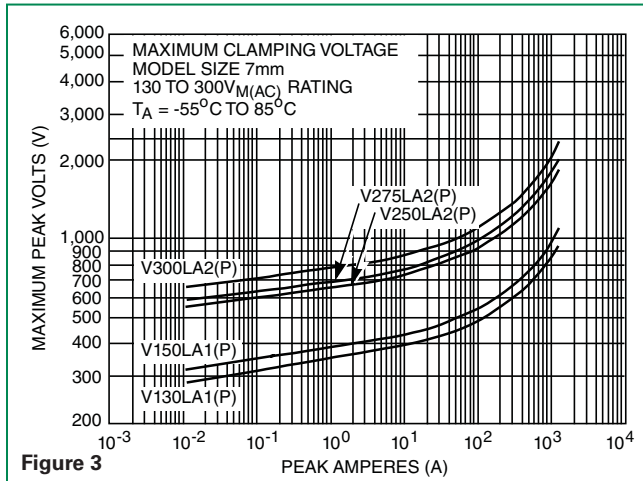


Figure 3

**Pulse Rating Curves**

**Repetitive Surge Capability for 7mm Parts**

V130LA1(P) - V480LA7(P)

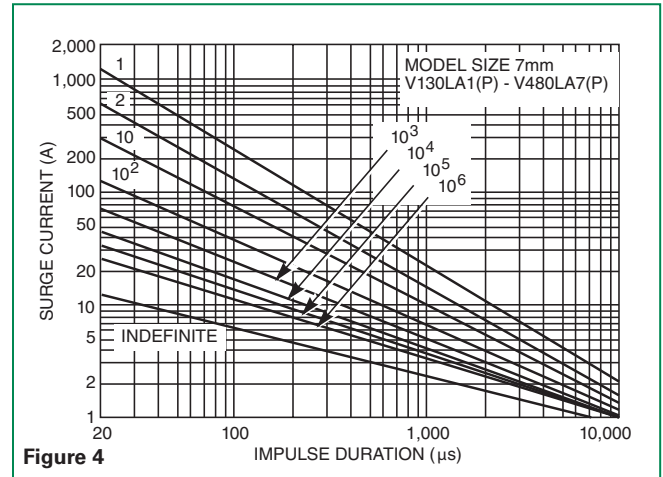


Figure 4

V130LA2(P) - V300LA4(P)

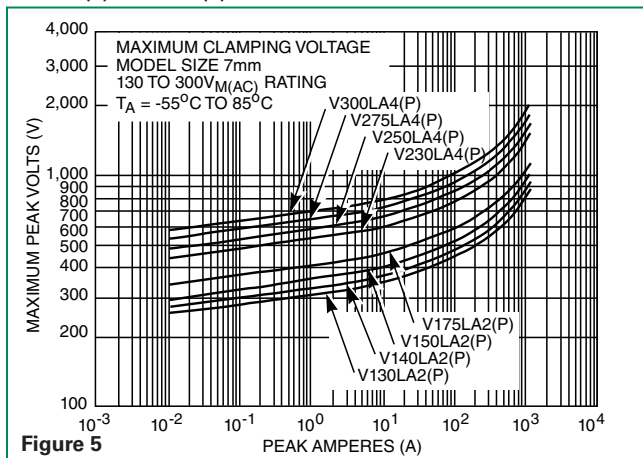


Figure 5

V320LA7(P) - V480LA7(P)

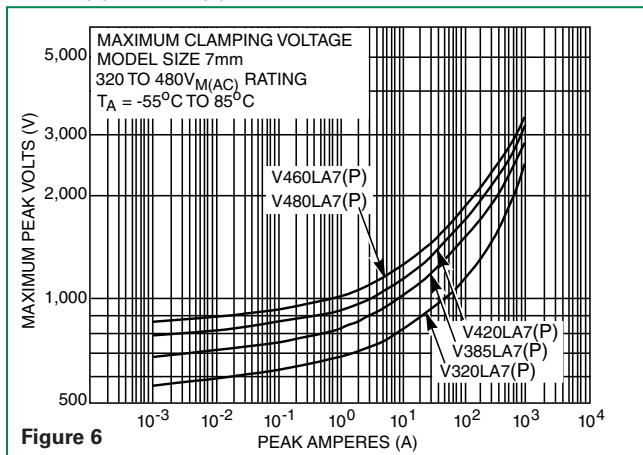


Figure 6

Transient V-I Characteristics Curves (Continued...)

Maximum Clamping Voltage for 10mm Parts

V130LA5(P) - V420LA10(P)

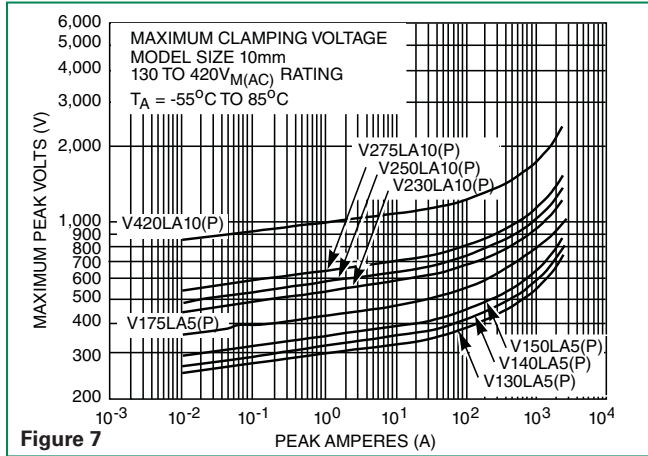


Figure 7

Pulse Rating Curves (Continued...)

Repetitive Surge Capability for 10mm Parts

V130LA5(P) - V680LA10(P)

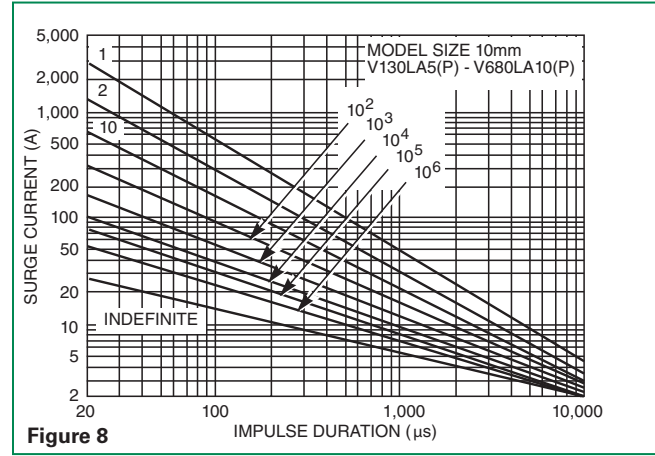


Figure 8

V300LA10(P) - V680LA10(P)

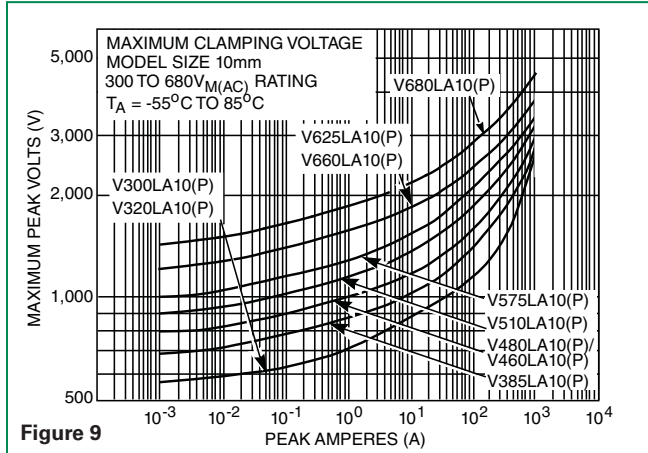


Figure 9



**Transient V-I Characteristics Curves (Continued...)**

**Maximum Clamping Voltage for 14mm Parts**

V130LA10A(P) - V320LA20A

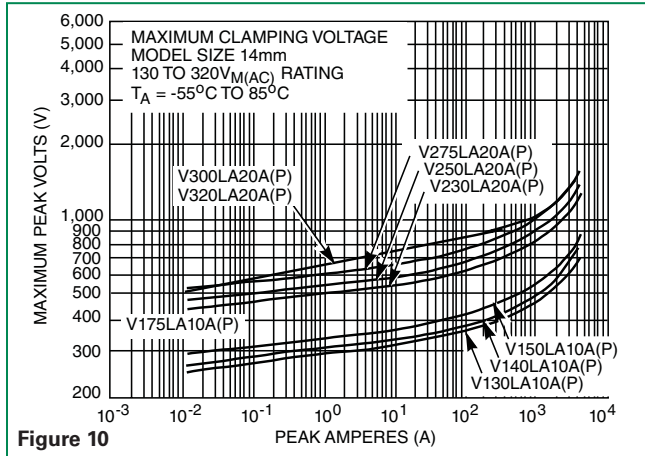


Figure 10

V385LA20A(P) V1000LA80A(P)

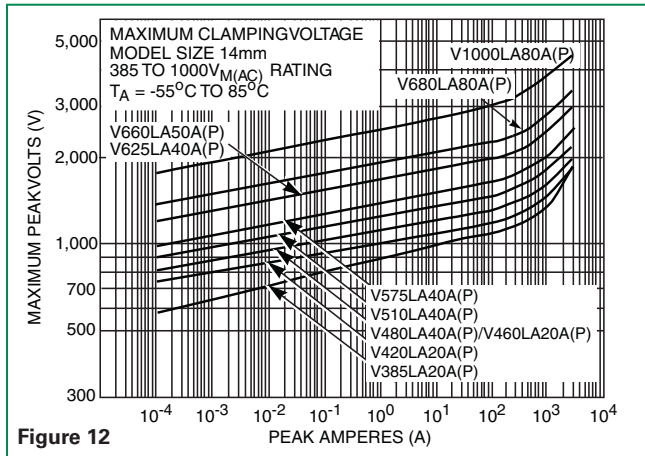


Figure 12

**Pulse Rating Curves (Continued...)**

**Repetitive Surge Capability for 14mm Parts**

V130LA10A(P) - V320LA20A(P)

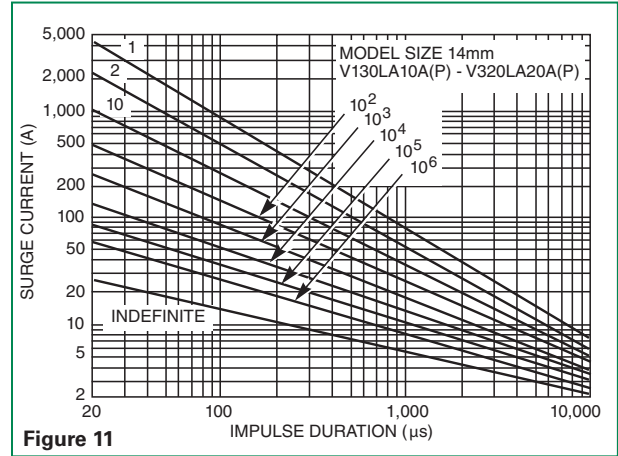


Figure 11

V385LA20A(P) - V1000LA80A(P)

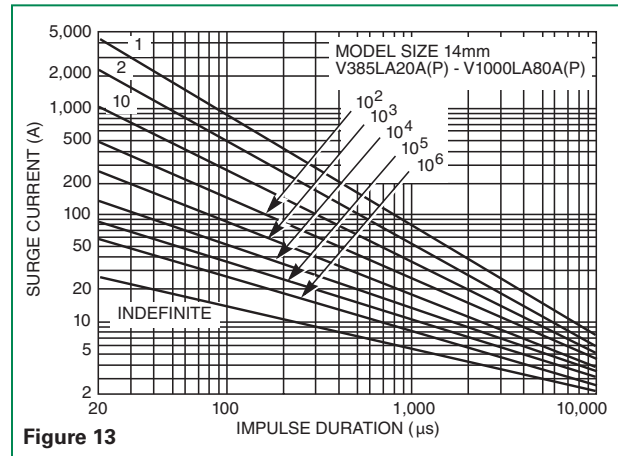


Figure 13

### Transient V-I Characteristics Curves (Continued...)

### Pulse Rating Curves (Continued...)

### Maximum Clamping Voltage for 20mm Parts

V130LA20A(P) - V275LA40A(P)

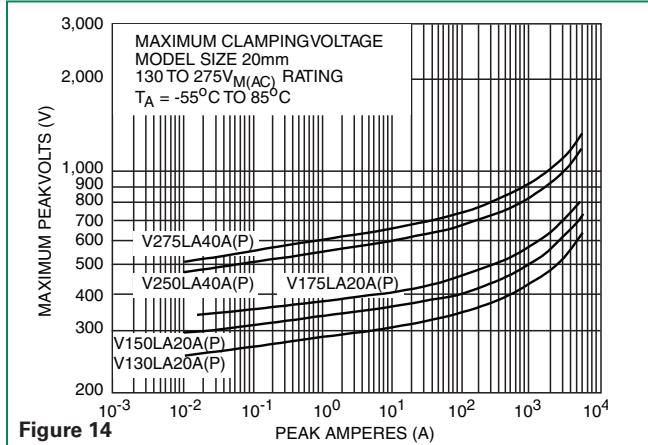


Figure 14

V300LA40A - V1000LA160B

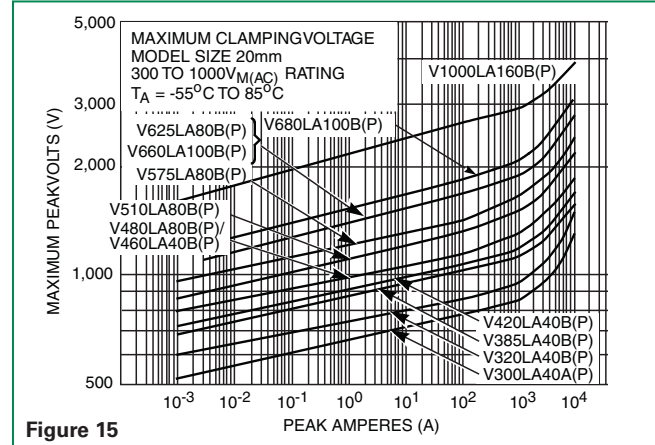


Figure 15

V130LA20B(P) - V275LA40(P)

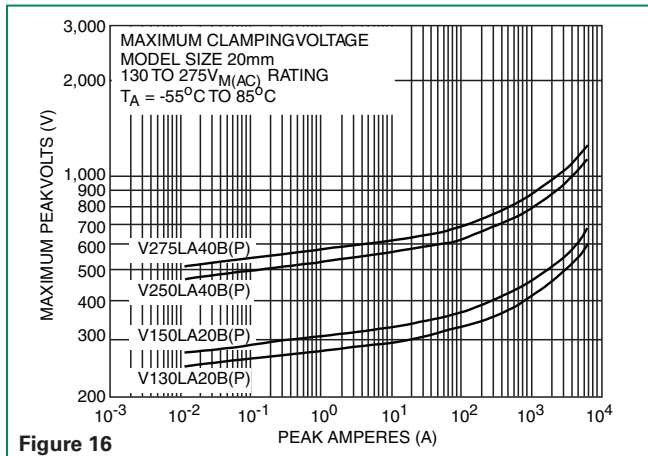


Figure 16

### Repetitive Surge Capability for 20mm Parts

V130LA20A(P) - V320LA40B(P)

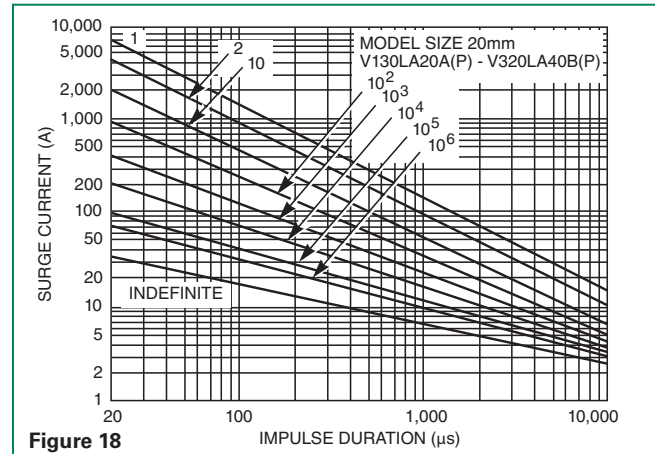


Figure 18

V130LA20A(P) - V275LA40A(P)

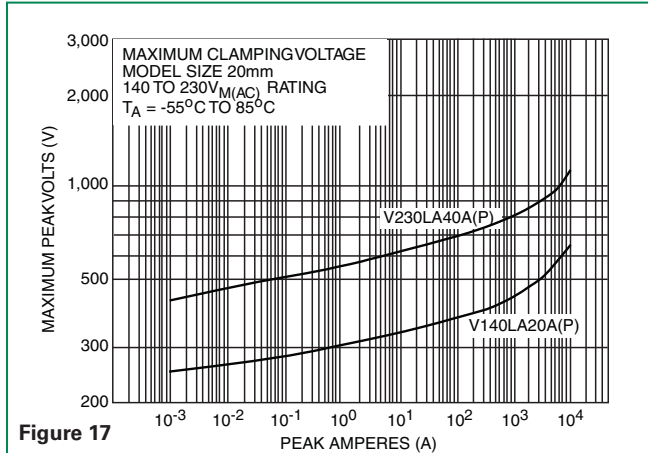


Figure 17

V385LA40B(P) - V1000LA160B(P)

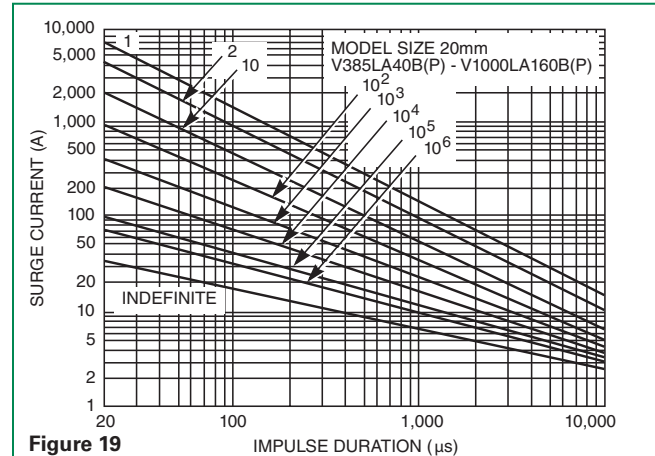


Figure 19

NOTE: If pulse ratings are exceeded, a shift of V<sub>NIDCI</sub> (at specified current) of more than +/-10% could result. This type of shift, which normally results in a decrease of V<sub>NIDCI</sub>, may result in the device not meeting the original published specifications, but does not prevent the device from continuing to function, and to provide ample protection.

**Wave Solder Profile**

**Non Lead-free Profile**

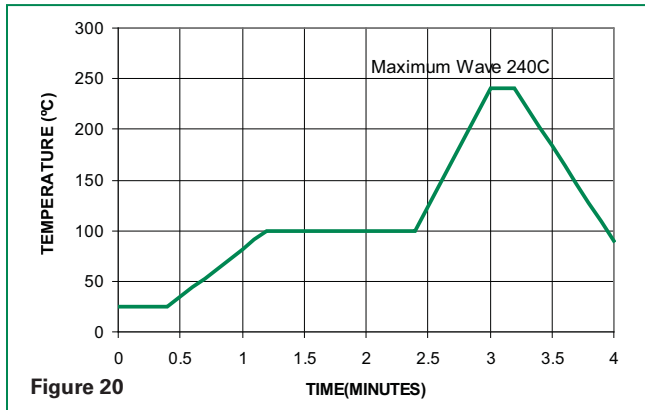


Figure 20

**Lead-free Profile**

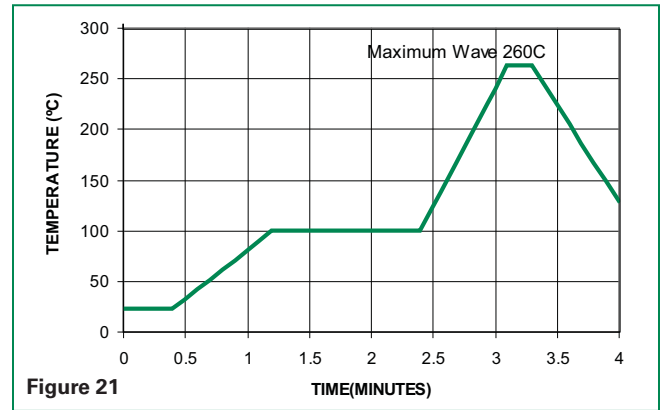


Figure 21

**Physical Specifications**

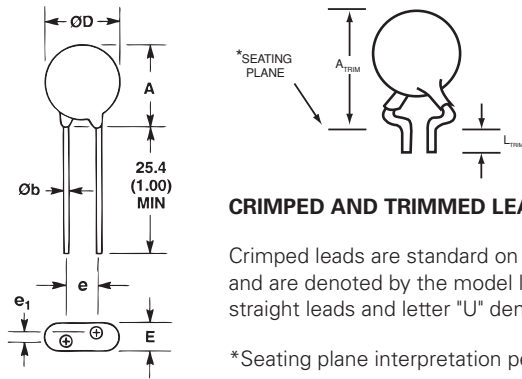
<b>Lead Material</b>	Tin-Coated Copper Wire
<b>Soldering Characteristics</b>	Solderability per MIL-STD-202, Method 208E
<b>Insulating Material</b>	Cured, flame retardant epoxy polymer meets UL94V-0 requirements
<b>Device Labeling</b>	Marked with LF, voltage, UL/CSA logos, and date code

**Environmental Specifications**

<b>Operating Ambient Temperature Range</b>	-55°C to +85°C
<b>Storage Temperature Range</b>	-55°C to +125°C
<b>Humidity Aging</b>	+85°C, 85% RH, 1000 hours +/-10% typical voltage change
<b>Thermal Shock</b>	+85°C to -40°C 5 times +/-10% typical voltage change
<b>Solvent Resistance</b>	MIL-STD-202, Method 215F
<b>Moisture Sensitivity</b>	Level 1, J-STD-020C

LA Series

### Product Dimensions (mm)



#### CRIMPED AND TRIMMED LEAD

Crimped leads are standard on LA types supplied in tape and reel and are denoted by the model letter "T." Model letter "S" denotes straight leads and letter "U" denotes special under-crimped leads.

\*Seating plane interpretation per IEC-717

Dimension	V <sub>RMS</sub> Voltage Model	7mm Size		10mm Size		14mm Size		20mm Size	
		Min. mm (in)	Max. mm (in)	Min. mm (in)	Max. mm (in)	Min. mm (in)	Max. mm (in)	Min. mm (in)	Max. mm (in)
A	V130LA-	-	12	-	16	-	20	-	26.5
	V320LA	-	(0.472)	-	(0.630)	-	(0.787)	-	(1.043)
	V385LA-	-	13	-	17	-	20.5	-	28
	V1000LA	-	(0.0512)	-	(0.689)	-	(0.807)	-	(1.102)
ØD	All	-	9 (0.354)	-	12.5 (0.492)	-	17 (0.669)	-	23 (0.906)
e	All	4 (0.157)	6 (0.236)	6.5 (0.256)	8.5 (0.335)	6.5 (0.256)	8.5 (0.335)	6.5 (0.256) (Note 2)	8.5 (Note 2)
e <sub>1</sub>	V130LA-	1.5	3.5	1.5	3.5	1.5	3.5	1.5	3.5
	V320LA	(0.059)	(0.138)	(0.059)	(0.138)	(0.059)	(0.138)	(0.059)	(0.138)
	V385LA-	2.5	5.5	2.5	5.5	2.5	5.5	2.5	5.5
	V1000LA	(0.098)	(0.217)	(0.098)	(0.217)	(0.098)	(0.217)	(0.098)	(0.217)
E	V130LA-	-	5.6	-	5.6	-	5.6	-	5.6
	V320LA	-	(0.220)	-	(0.220)	-	(0.220)	-	(0.220)
	V385LA-	-	7.3	-	7.3	-	7.3	-	7.3
	V510LA	-	(0.287)	-	(0.287)	-	(0.287)	-	(0.287)
	V550LA-	-	8.3	-	8.3	-	8.3	-	8.3
	V680LA	-	(0.327)	-	(0.327)	-	(0.327)	-	(0.327)
E	V1000LA	-	-	-	-	-	10.8 (0.425)	-	10.8 (0.425)
	V1000LA	-	-	-	-	-	10.8 (0.425)	-	10.8 (0.425)
Øb	All (Note 3)	0.585 (0.023)	0.685 (0.027)	0.76 (0.030)	0.86 (0.034)	0.76 (0.030)	0.86 (0.034)	0.76 (0.030) (Note 2)	0.86 (0.034) (Note 2)
A <sub>TRIM</sub>	All	-	15 (0.591)	-	19.5 (0.768)	-	22.5 (0.886) (NOTE 4)	-	29.0 (1.142)
L <sub>TRIM</sub>	All	2.41 (0.095)	4.69 (0.185)	2.41 (0.095)	4.69 (0.185)	2.41 (0.095)	4.69 (0.185)	2.41 (0.095)	4.69 (0.185)

Notes :

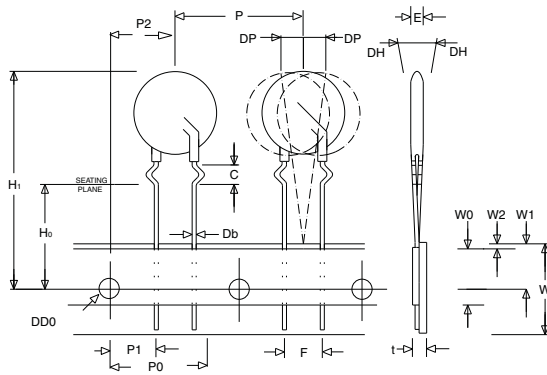
- Dimensions in millimeters, (inches) in parentheses.
- 10mm (9mm Min. & 11mm Max.) ALSO AVAILABLE; see additional lead style options
- 1000V parts supplied with lead wire of diameter 1.00 +/- 0.05 (0.039 +/- 0.002)
- 'A' Max. for V1000LC80A (P) = 24.00 (0.945")

**Tape and Reel Specifications**

(Dimensions presented on following page.)

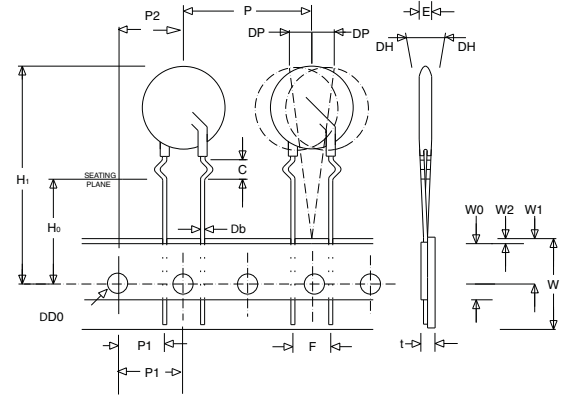
**7mm Devices**

CRIMPED LEADS "LT"

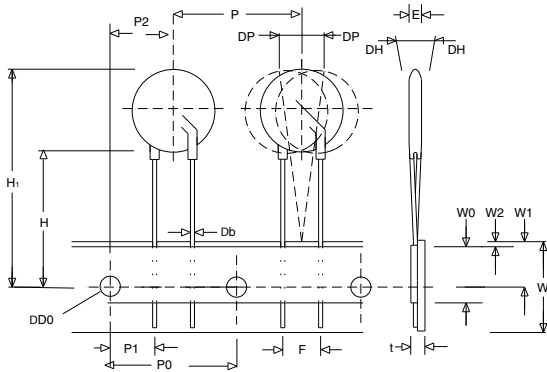


**10, 14 and 20mm Devices**

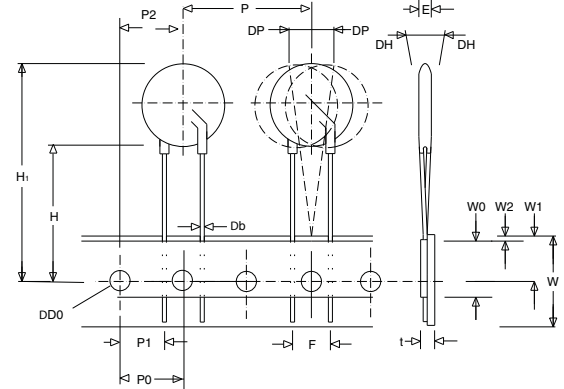
CRIMPED LEADS "LT"



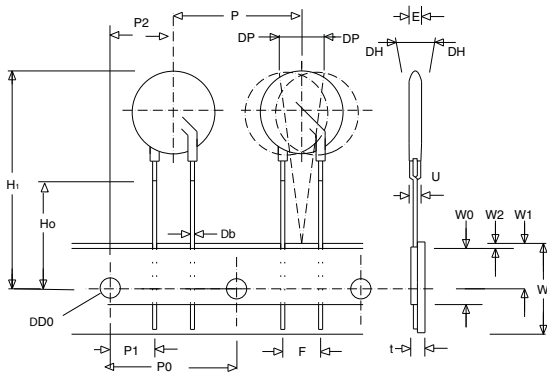
STRAIGHT LEADS "LS"



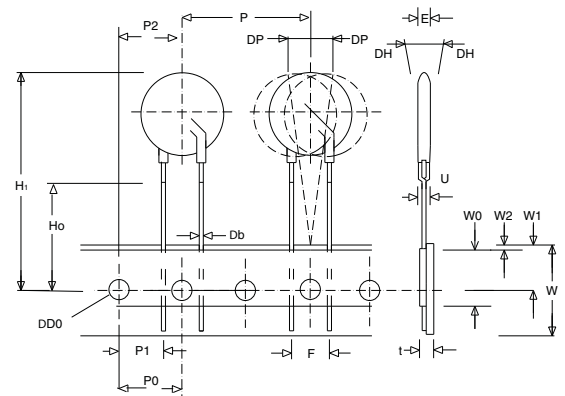
STRAIGHT LEADS "LS"



UNDER-CRIMPED LEADS "LU"



UNDER-CRIMPED LEADS "LU"



### Tape and Reel Specifications (continued)

- Conforms to ANSI and EIA specifications
- Can be supplied to IEC Publication 286-2
- Radial devices on tape are supplied with crimped leads, straight leads, or under-crimped leads
- 7mm parts are available on tape and reel up to 480 VAC only
- 10mm parts are available on tape and reel up to 510 VAC only
- 14mm and 20mm parts are available on tape and reel up to 550 VAC only

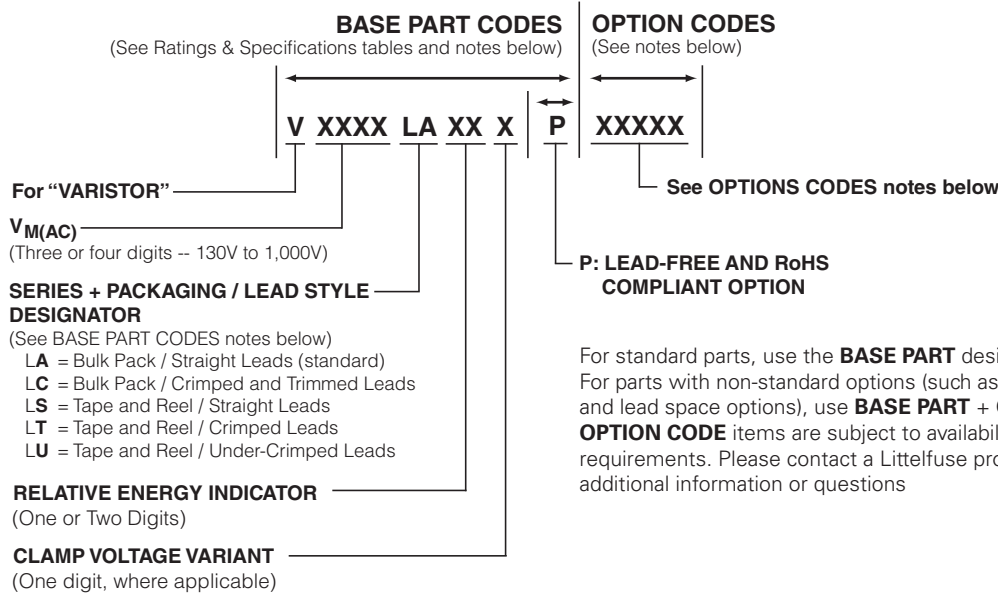
Symbol	Description	Model Size			
		7mm	10mm	14mm	20mm
<b>P</b>	Pitch of Component	12.7 +/- 1.0	25.4 +/- 1.0	25.4 +/- 1.0	25.4 +/- 1.0
<b>P<sub>0</sub></b>	Feed Hole Pitch	12.7 +/- 0.2	12.7 +/- 0.2	12.7 +/- 0.2	12.7 +/- 0.2
<b>P<sub>1</sub></b>	Feed Hole Center to Pitch	3.85 +/- 0.7	8.85 +/- 0.7	8.85 +/- 0.7	8.85 +/- 0.7
<b>P<sub>2</sub></b>	Hole Center to Component Center	6.35 +/- 0.7	12.7 +/- 0.7	12.7 +/- 0.7	12.7 +/- 0.7
<b>F</b>	Lead to Lead Distance	5.0 +/- 0.8	7.5 +/- 0.8	7.5 +/- 0.8	7.5 +/- 0.8
<b>h</b>	Component Alignment	2.0 Max	2.0 Max	2.0 Max	2.0 Max
<b>W</b>	Tape Width	18.0 +1.0 / -0.5	18.0 +1.0 / -0.5	18.0 +1.0 / -0.5	18.0 +1.0 / -0.5
<b>W<sub>0</sub></b>	Hold Down Tape Width	12.0 +/- 0.3	12.0 +/- 0.3	12.0 +/- 0.3	12.0 +/- 0.3
<b>W<sub>1</sub></b>	Hole Position	9.0 +0.75 / -0.50	9.0 +0.75 / -0.50	9.0 +0.75 / -0.50	9.0 +0.75 / -0.50
<b>W<sub>2</sub></b>	Hold Down Tape Position	0.5 Max	0.5 Max	0.5 Max	0.5 Max
<b>H</b>	Height from Tape Center to Component Base	18.0 +2.0 / -0.0	18.0 +2.0 / -0.0	18.0 +2.0 / -0.0	18.0 +2.0 / -0.0
<b>H<sub>0</sub></b>	Seating Plane Height	16.0 +/- 0.5	16.0 +/- 0.5	16.0 +/- 0.5	16.0 +/- 0.5
<b>H<sub>1</sub></b>	Component Height	32.0 Max	36.0 Max	40.0 Max	46.5 Max
<b>D<sub>0</sub></b>	Feed Hole Diameter	4.0 +/- 0.2	4.0 +/- 0.2	4.0 +/- 0.2	4.0 +/- 0.2
<b>T</b>	Total Tape Thickness	0.7 +/- 0.2	0.7 +/- 0.2	0.7 +/- 0.2	0.7 +/- 0.2
<b>U</b>	Under-crimp Width	8.0 Max	8.0 Max	8.0 Max	8.0 Max
<b>P</b>	Component Alignment	3° Max 1.00mm	3° Max 1.00mm	3° Max 1.00mm	3° Max

NOTE: Dimensions are in mm.

### Standard Bulk Pack Quantity

Varistor Voltage Model	Standard Bulk Pack Quantity			
	Varistor Model Size			
	7mm	10mm	14mm	20mm
130-275	1500	1000	700	500
300-460	1500	1000	600	400
510-625	1500	1000	500	400
660	N/A	1000	500	400
680	N/A	1000	400	300
1000	N/A	N/A	300	200

**Part Numbering System**



**Ordering Notes:**

**BASE PART CODES:**

**Series + Packaging / Lead Style Designators:**

Ordering examples:

Straight Lead Bulk Pack (standard)	Straight Lead Tape & Reel	Crimped Lead Tape & Reel	Crimped & Trimmed Lead Bulk Pack	Under-Crimp Lead Tape & Reel
V130LA2	V130LS2	V130LT2	V130LC2	V130LU2

Crimped leads are standard on LA Series varistors supplied in tape and reel, denoted with "LT." For crimped leads without trimming and any variations other than that described above, please contact Littelfuse.

Littelfuse LA Series varistors are shipped standard in bulk pack with straight leads and lead spacing outlined in the Package Dimensions section of this data sheet. Contact your Littelfuse sales representative to discuss non-standard options.

**Lead-free / RoHS Designator:**

For Lead-free and RoHS compliant parts add "P" after the BASE PART number and before any other OPTION CODE:

Standard Model	Order As
V130LA2	V130LA2P
Standard Model with Option	Order As
V420LA20AX1347	V420LA20APX1347

**OPTION CODES:**

**X10:** 10mm lead spacing option --

For 10 (-/+1) mm lead spacing (available on 20mm diameter models only), append standard model BASE PART number with "X10." Example:

Standard Model	Order As
V130LA20A	V130LA20AX10

**X2855:** Nickel Barrier coated wire option --

All standard parts use Tin-coated Copper wire. Nickel Barrier coated wire is available as an option, consisting of Copper wire with a flashing of Nickel followed by a top coating of Tin. To order append standard model BASE PART number with "X2855." Example:

Standard Model	Order As
V130LA20A	V130LA20AX2855

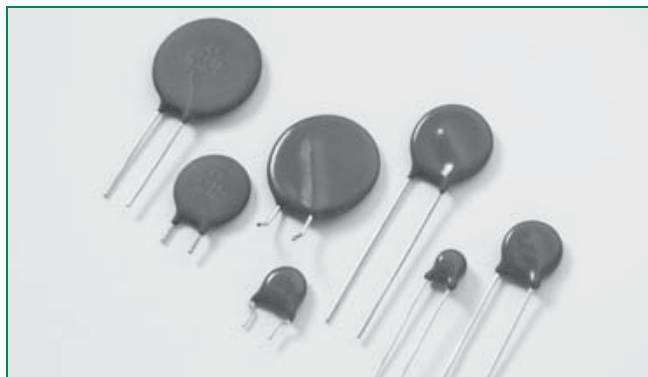
**X1347:** Hi-Temperature phenolic coated option --

Phenolic Coated LA Series devices are available with improved maximum operating maximum temperature of 125°C. For additional information see bottom of page 113.

To order, add X1347 to end of part number (V230LA20AX1347 or V230LA20APX1347 for Lead Free/RoHS version).








**RoHS (Pb) ZA Varistor Series**

**Description**

The ZA Series of transient voltage surge suppressors are radial leaded varistors (MOVs) designed for use in the protection of low and medium-voltage circuits and systems. Typical applications include motor control, telecom, automotive systems, solenoid, and power supply circuits to protect circuit board components and maintain data integrity.

These devices are available in five model sizes: 5mm, 7mm, 10mm, 14mm and 20mm, and feature a wide  $V_{DC}$  voltage range of 5.5V to 615V.

See ZA Series Device Ratings and Specifications Table for part number and brand information.

**Agency Approvals**

Agency	Agency File Number
	E135010, (+ E320116 for selected parts)
	116895E
	42201-006

**Features**

- Lead-free and RoHS compliant option available. Please see the device and ratings specifications table for more information.
- Wide operating voltage range  $V_{M(AC)RMS}$  4V to 460V
- DC voltage ratings 5.5V to 615V
- No derating up to 85°C ambient
- 5 model sizes available: 5, 7, 10, 14, and 20mm
- Radial lead package for hard-wired or printed circuit board designs
- Available in tape and reel or bulk pack
- Standard lead form options

**ZA Series**
**Absolute Maximum Ratings**

• For ratings of individual members of a series, see Device Ratings and Specifications chart

Continuous	ZA Series	Units
Steady State Applied Voltage:		
AC Voltage Range ( $V_{M(AC)RMS}$ )	4 to 460	V
DC Voltage Range ( $V_{M(DC)}$ )	5.5 to 615	V
Transients:		
Peak Pulse Current ( $I_{TM}$ )		
For 8/20 $\mu$ s Current Wave (See Figure 2)	50 to 6500	A
Single Pulse Energy Range (Note 1)		
For 10/1000 $\mu$ s Current Wave ( $W_{TM}$ )	0.1 to 52	J
Operating Ambient Temperature Range ( $T_A$ )	-55 to +85	°C
Storage Temperature Range ( $T_{STG}$ )	-55 to +125	°C
Temperature Coefficient ( $\alpha^V$ ) of Clamping Voltage ( $V_C$ ) at Specified Test Current	<0.01	%/°C
Hi-Pot Encapsulation (COATING Isolation Voltage Capability) (Dielectric must withstand indicated DC voltage for one minute per MIL-STD-202, Method 301)	2500	V
COATING Insulation Resistance	1000	M $\Omega$

**CAUTION:** Stresses above those listed in "Absolute Maximum Ratings" may cause permanent damage to the device. This is a stress only rating and operation of the device at these or any other conditions above those indicated in the operational sections of this specification is not implied.

### ZA Series Ratings & Specifications

Lead-free and RoHS Compliant Models		Standard Models		Model Size Disc Dia. (mm)	Maximum Rating (85°C)				Specifications (25°C)				
					Continuous		Transient		Varistor Voltage at 1mA DC Test Current		Maximum Clamping Voltage 8 x 20µs		Typical Capacitance f = 1MHz
					V <sub>RMS</sub>	V <sub>DC</sub>	Energy 10 x 1000µs	Peak Current 8 x 20µs					
Part Number	Branding	Part Number	Branding	V <sub>M(AC)</sub> (V)	V <sub>M(DC)</sub> (V)	W <sub>TM</sub> (J)	I <sub>TM</sub> (A)	V <sub>NOM</sub> Min (V)	V <sub>NOM</sub> Max (V)	V <sub>C</sub> (V)	I <sub>PK</sub> (A)	C (pF)	
V8ZA05P	PZ08	V8ZA05	Z08	5	4	5.5	0.1	50	6	11	30	1	2000
V8ZA1P	P08Z1	V8ZA1	08Z1	7	4	5.5	0.4	100	6	11	22	2.5	4190
V8ZA2P	P08Z2	V8ZA2	08Z2	10	4	5.5	0.8	250	6	11	20	5	7000
V12ZA05P	PZ12	V12ZA05	Z12	5	6	8	0.14	50	9	16	37	1	1700
V12ZA1P	P12Z1	V12ZA1	12Z1	7	6	8	0.6	100	9	16	34	2.5	3350
V12ZA2P	P12Z2	V12ZA2	12Z2	10	6	8	1.2	250	9	16	30	5	6100
V18ZA05P	PZ18	V18ZA05	Z18	5	10	14	0.17	100	14.4	21.6	36	1	1400
V18ZA1P	P18Z1	V18ZA1	18Z1	7	10	14	0.8	250	14.4	21.6	36	2.5	2700
V18ZA2P	P18Z2	V18ZA2	18Z2	10	10	14	1.5	500	14.4	21.6	36	5	5300
V18ZA3P	P18Z3	V18ZA3	18Z3	14	10	14	3.5	1000	14.4	21.6	36	10	18870
V18ZA40P	P18Z40	V18ZA40	18Z40	20	10	14	80 (Note2)	2000	14.4 (Note 3)	21.6	37	20	22000
V22ZA05P	PZ22	V22ZA05	Z22	5	14	18	0.2	100	18.7	26	43	1	1220
V22ZA1P	P22Z1	V22ZA1	22Z1	7	14	18	0.9	250	18.7	26	43	2.5	2375
V22ZA2P	P22Z2	V22ZA2	22Z2	10	14	18	2	500	18.7	26	43	5	4500
V22ZA3P	P22Z3	V22ZA3	22Z3	14	14	18	4	1000	18.7	26	43	10	14730
V24ZA50P	P24Z50	V24ZA50	24Z50	20	14	18 (Note 4)	100 (Note 2)	2000	19.2 (Note 3)	26	43	20	18000
V27ZA05P	PZ27	V27ZA05	Z27	5	17	22	0.25	100	23	31.1	53	1	920
V27ZA1P	P27Z1	V27ZA1	27Z1	7	17	22	1	250	23	31.1	53	2.5	1875
V27ZA2P	P27Z2	V27ZA2	27Z2	10	17	22	2.5	500	23	31.1	53	5	3850
V27ZA4P	P27Z4	V27ZA4	27Z4	14	17	22	5	1000	23	31.1	53	10	11480
V27ZA60P	P27Z60	V27ZA60	27Z60	20	17	22	120 (Note 2)	2000	23 (Note 3)	31.1	50	20	13000
V33ZA05P	PZ33	V33ZA05	Z33	5	20	26	0.3	100	29.5	38	65	1	790
V33ZA1P	P33Z1	V33ZA1	33Z1	7	20	26	1.2	250	29.5	36.5	65	2.5	1620
V33ZA2P	P33Z2	V33ZA2	33Z2	10	20	26	3	500	29.5	36.5	65	5	3495
V33ZA5P	P33Z5	V33ZA5	33Z5	14	20	26	6	1000	29.5	36.5	65	10	9290
V33ZA70P	P33Z70	V33ZA70	33Z70	20	21	27	150 (Note 2)	2000	29.5 (Note 3)	36.5	58	20	13000
V36ZA80P	P36Z80	V36ZA80	36Z80	20	23	31	160 (Note 2)	2000	32 (Note 3)	40	63	20	12000
V39ZA05P	PZ39	V39ZA05	Z39	5	25	31	0.3	100	35	46	79	1	675
V39ZA1P	P39Z1	V39ZA1	39Z1	7	25	31	1.2	250	35	43	79	2.5	1350
V39ZA3P	P39Z3	V39ZA3	39Z3	10	25	31	3	500	35	43	76	5	3100
V39ZA6P	P39Z6	V39ZA6	39Z6	14	25	31	7.2	1000	35	43	76	10	7000
V39ZA20P	P39Z20	V39ZA20	39Z20	20	25	31	20	2000	35	43	76	20	12000
V47ZA05P	PZ47	V47ZA05	Z47	5	30	38	0.4	100	42	55	93	1	585
V47ZA1P	P47Z1	V47ZA1	47Z1	7	30	38	1.8	250	42	52	93	2.5	1245
V47ZA3P	P47Z3	V47ZA3	47Z3	10	30	38	4.5	500	42	52	93	5	2590
V47ZA7P	P47Z7	V47ZA7	47Z7	14	30	38	8.8	1000	42	52	93	10	6270
V47ZA20P	P47Z20	V47ZA20	47Z20	20	30	38	23	2000	42	52	93	20	11000
V56ZA05P	PZ56	V56ZA05	Z56	5	35	45	0.5	100	50	66	110	1	500
V56ZA2P	P56Z2	V56ZA2	56Z2	7	35	45	2.3	250	50	62	110	2.5	1035
V56ZA3P	P56Z3	V56ZA3	56Z3	10	35	45	5.5	500	50	62	110	5	2150
V56ZA8P	P56Z8	V56ZA8	56Z8	14	35	45	10	1000	50	62	110	10	4840
V56ZA20P	P56Z20	V56ZA20	56Z20	20	35	45	30	2000	50	62	110	20	10000
V68ZA05P	PZ68	V68ZA05	Z68	5	40	56	0.6	100	61	80	135	1	400
V68ZA2P	P68Z2	V68ZA2	68Z2	7	40	56	3	250	61	75	135	2.5	910

### ZA Series Ratings & Specifications (Continued...)

Lead-free and RoHS Compliant Models		Standard Models		Model Size Disc Dia. (mm)	Maximum Rating (85°C)				Specifications (25°C)				
					Continuous		Transient		Varistor Voltage at 1mA DC Test Current		Maximum Clamping Voltage 8 x 20µs		Typical Capacitance f = 1MHz
					V <sub>RMS</sub>	V <sub>DC</sub>	Energy 10 x 1000µs	Peak Current 8 x 20µs					
Part Number	Branding	Part Number	Branding	V <sub>M(AC)</sub>	V <sub>M(DC)</sub>	W <sub>TM</sub>	I <sub>TM</sub>	(V)	(V)	(V)	(A)	(pF)	
V68ZA3P	P68Z3	V68ZA3	68Z3	10	40	56	6.5	500	61	75	135	5	1850
V68ZA10P	P68Z10	V68ZA10	68Z10	14	40	56	13	1000	61	75	135	10	3870
V68ZA20P	P68Z20	V68ZA20	68Z20	20	40	56	33	2000	61	75	135	20	9000
V82ZA05P	PZ82	V82ZA05	Z82	5	50	68	2	400	73	97	135	5	355
V82ZA2P	P82Z2	V82ZA2	82Z2	7	50	68	4	1200	73	91	135	10	700
V82ZA4P	P82Z4	V82ZA4	82Z4	10	50	68	8	2500	73	91	135	25	1485
V82ZA12P	P82Z12	V82ZA12	82Z12	14	50	68	15	4500	73	91	145	50	3380
V100ZA05P	PZ100	V100ZA05	Z100	5	60	81	2.5	400	90	117	165	5	310
V100ZA3P	P100Z	V100ZA3	100Z	7	60	81	5	1200	90	110	165	10	600
V100ZA4P	P100Z4	V100ZA4	100Z4	10	60	81	10	2500	90	110	165	25	1200
V100ZA15P	P100Z15	V100ZA15	100Z15	14	60	81	20	4500	90	110	175	50	2900
V120ZA05P	PZ120	V120ZA05	Z120	5	75	102	3	400	108	138	205	5	250
V120ZA1P	P120Z	V120ZA1	120Z	7	75	102	6	1200	108	132	205	10	515
V120ZA4P	P120Z4	V120ZA4	120Z4	10	75	102	12	2500	108	132	200	25	1100
V120ZA6P	P120Z6	V120ZA6	120Z6	14	75	102	22	4500	108	132	210	50	2450
V120ZA20P	P120Z20	V120ZA20	120Z20	20	75	102	33	6500	108	132	210	100	5000
V150ZA05P	PZ150	V150ZA05	Z150	5	92	127	4	400	135	173	250	5	190
V150ZA1P	PZ051	V150ZA1	Z051	7	95	127	8	1200	135	165	250	10	460
V150ZA4P	P150Z4	V150ZA4	150Z4	10	95	127	15	2500	135	165	250	25	860
V150ZA8P	P150Z8	V150ZA8	150Z8	14	95	127	20	4500	135	165	250	50	1910
V150ZA20P	P150Z20	V150ZA20	150Z20	20	95	127	45	6500	135	165	250	100	3500
V180ZA05P	PZ180	V180ZA05	Z180	5	110	153	5	400	162	207	295	5	100
V180ZA1P	P180Z	V180ZA1	180Z	7	115	153	10	1200	162	198	300	10	320
V180ZA5P	P180Z5	V180ZA5	180Z5	10	115	153	18	2500	162	198	300	25	465
V180ZA10P	P180Z10	V180ZA10	180Z10	14	115	153	35	4500	162	198	300	50	1190
V180ZA20P	P180Z20	V180ZA20	180Z20	20	115	153	52	6500	162	198	300	100	2400
V205ZA05P	PZ205	V205ZA05	Z205	5	130	170	5.5	400	184	226	340	5	100
V220ZA05P	PZ220	V220ZA05	Z220	5	140	180	6	400	198	253	360	5	95
†V240ZA05P	PZ240	V240ZA05	Z240	5	150	200	7	400	216	264	395	5	90
†V270ZA05P	PZ270	V270ZA05	Z270	5	175	225	7.5	400	243	311	455	5	75
†V330ZA05P	PZ330	V330ZA05	Z330	5	210	275	9	400	297	380	540	5	70
†V360ZA05P	PZ360	V360ZA05	Z360	5	230	300	9.5	400	324	396	595	5	60
†V390ZA05P	PZ390	V390ZA05	Z390	5	250	330	10	400	351	449	650	5	80
†V430ZA05P	PZ430	V430ZA05	Z430	5	275	369	11	400	387	495	710	5	75
†V470ZA05P	PZ470	V470ZA05	Z470	5	300	385	12	400	420	517	775	5	70
†V620ZA05P	PZ620	V620ZA05	Z620	5	385	505	13	400	558	682	1025	5	45
†V680ZA05P	PZ680	V680ZA05	Z680	5	420	560	14	400	610	748	1120	5	40
†V715ZA05P	PZ715	V715ZA05	Z715	5	440	585	15.5	400	643	787	1180	5	35
†V750ZA05P	PZ750	V750ZA05	Z750	5	460	615	17	400	675	825	1240	5	30

Note:

1. Average power dissipation of transients not to exceed 0.2W, 0.25W, 0.4W, 0.6W or 1W for model sizes 5mm, 7mm, 10mm, 14mm and 20mm, respectively.
  2. Energy rating for impulse duration of 30ms minimum to one half of peak current (auto Load Dump).
  3. 10mA DC test current.
  4. Also rated to withstand 24V for 5 minutes.
  5. Higher voltages available, contact Littelfuse.
  6. Capacitance Values shown are TYPICAL.
- † Also Recognized to UL 1449, Transient Voltage Surge Suppressors File E320116

### Power Dissipation Ratings

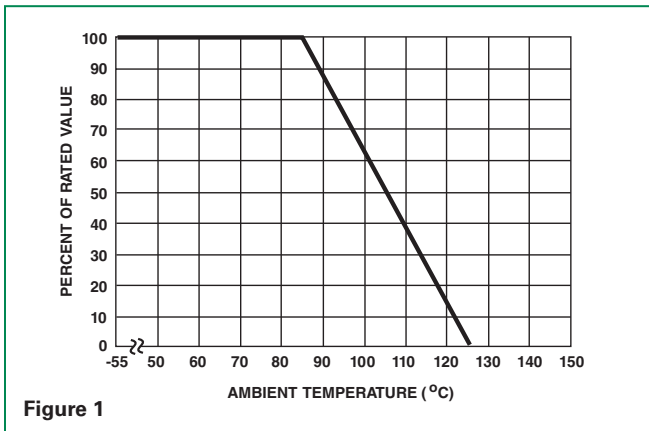


Figure 1

Should transients occur in rapid succession, the average power dissipation required is simply the energy (watt-seconds) per pulse times the number of pulses per second. The power so developed must be within the specifications shown on the Device Ratings and Specifications Table for the specific device. Furthermore, the operating values need to be derated at high temperatures as shown in the diagram above. Because varistors can only dissipate a relatively small amount of average power they are, therefore, not suitable for repetitive applications that involve substantial amounts of average power dissipation.

### Peak Pulse Current Test Waveform

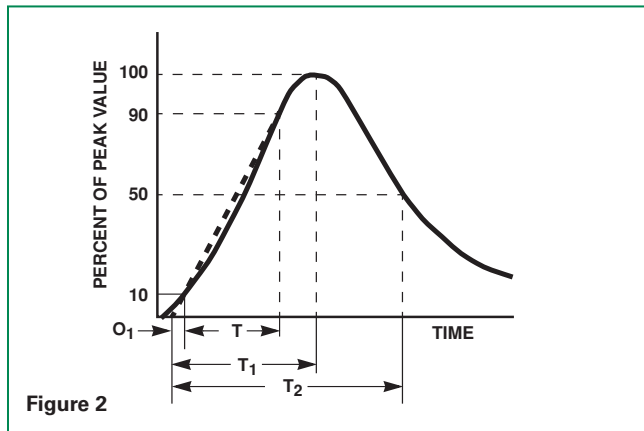


Figure 2

$O_1$  = Virtual Origin of Wave  
 $T$  = Time from 10% to 90% of Peak  
 $T_1$  = Rise Time =  $1.25 \times T$   
 $T_2$  = Decay Time

**Example** - For an 8/20  $\mu$ s Current Waveform:

$8\mu s = T_1$  = Rise Time  
 $20\mu s = T_2$  = Decay Time

### Maximum Clamping Voltage for 5mm Parts

#### V8ZA05(P) - V68ZA05(P)

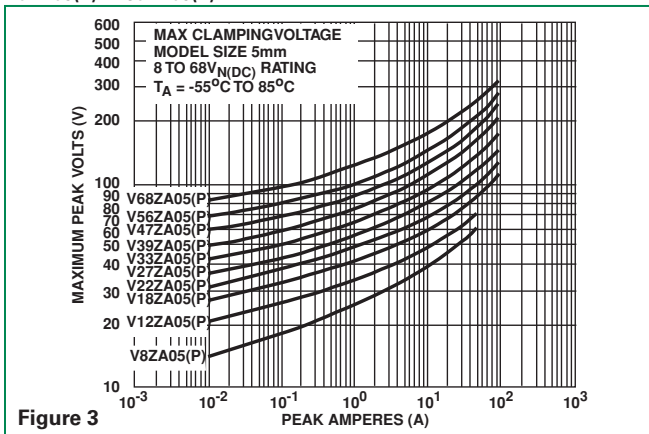


Figure 3

#### V82ZA05(P) - V330ZA05(P)

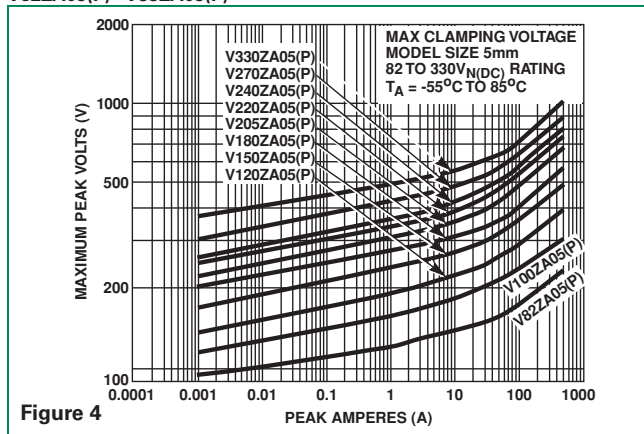


Figure 4

#### V360ZA05(P) - V750ZA05(P)

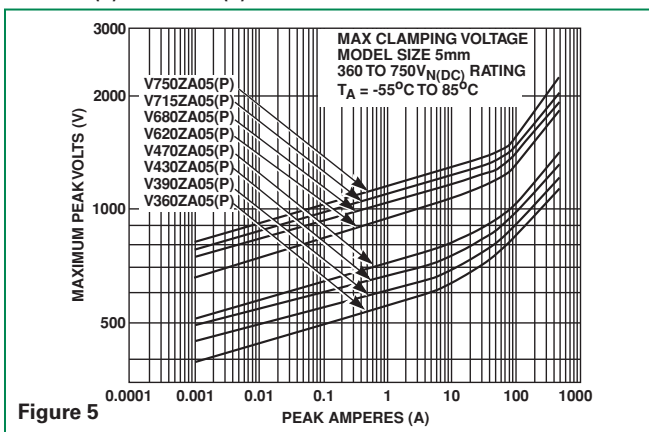
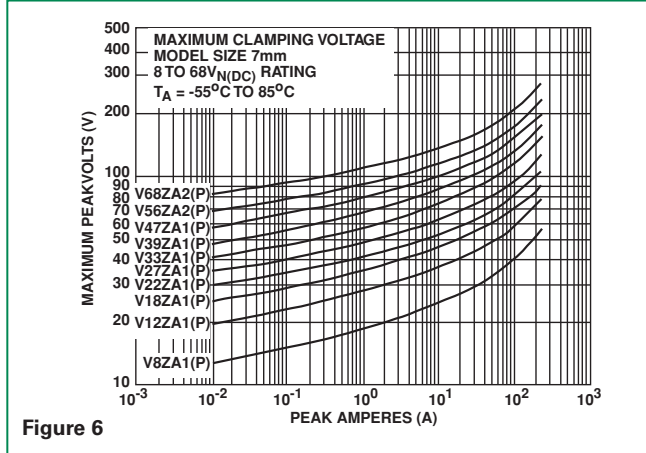


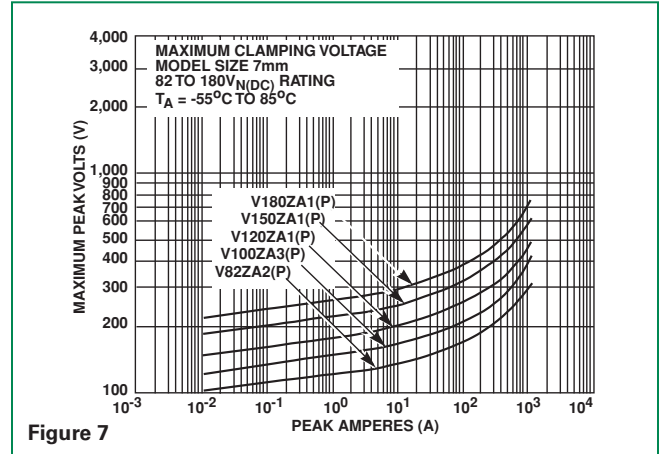
Figure 5

**Maximum Clamping Voltage for 7mm Parts**

V8ZA1(P) - V68ZA2(P)

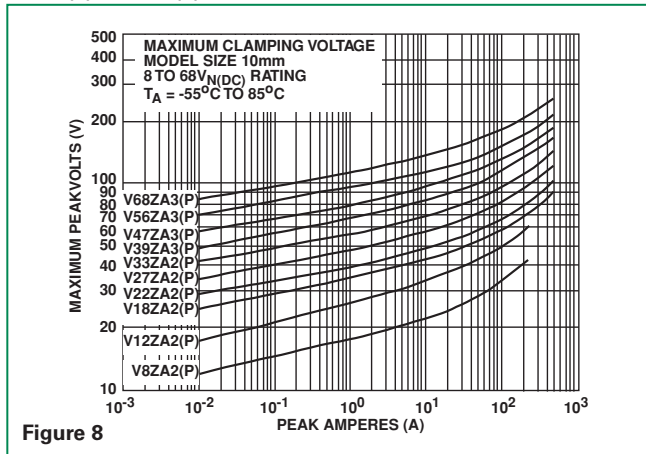


V82ZA2(P) - V180ZA1(P)

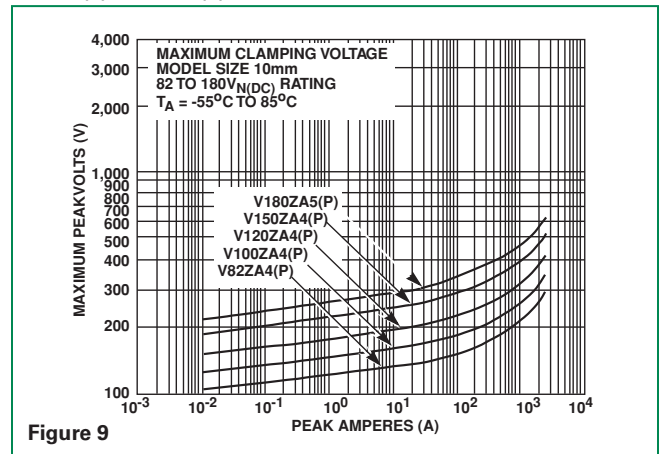


**Maximum Clamping Voltage for 10mm Parts**

V8ZA2(P) - V68ZA3(P)

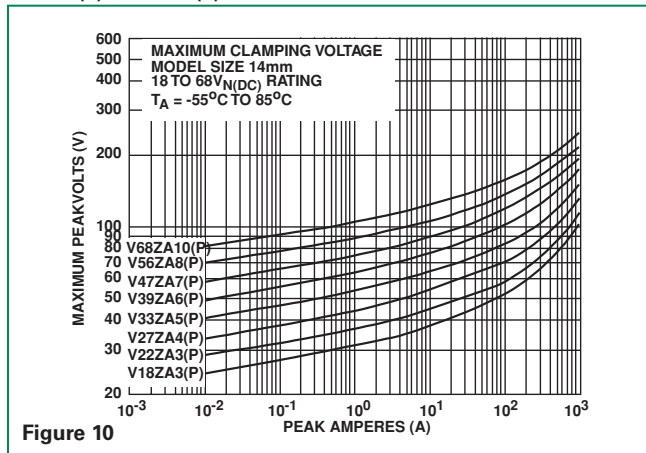


V82ZA4(P) - V180ZA5(P)

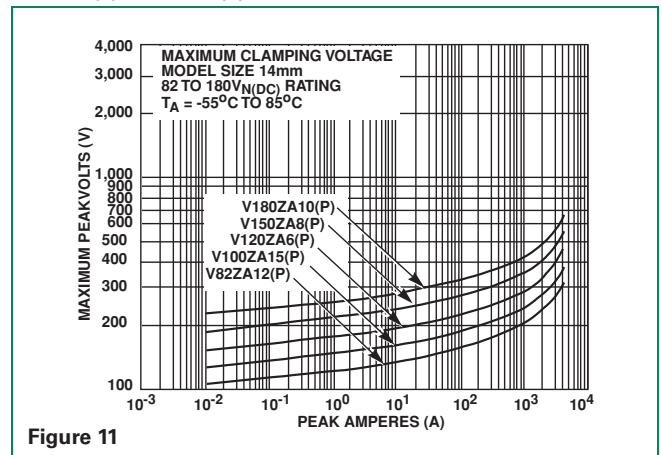


**Maximum Clamping Voltage for 14mm Parts**

V18ZA3(P) - V68ZA10(P)



V82ZA12(P) - V180ZA10(P)



ZA Series

### Maximum Clamping Voltage for 20mm Parts

V18ZA40(P) - V36ZA80(P)

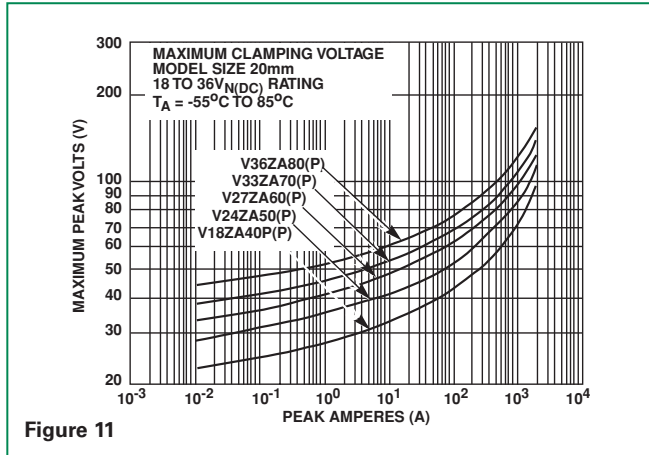


Figure 11

V39ZA20(P) - V180ZA20(P)

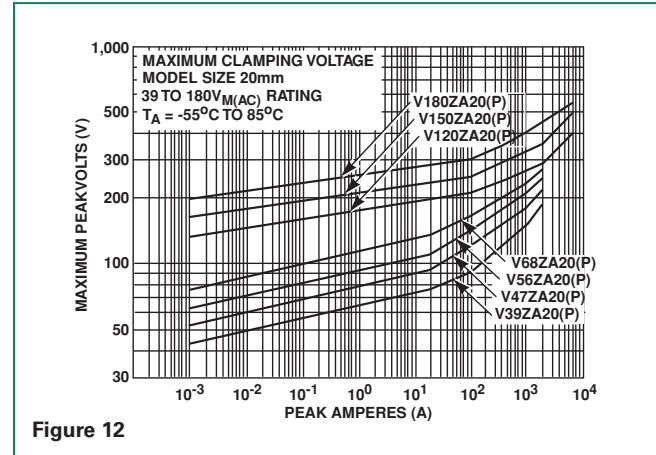


Figure 12

### Repetitive Surge Capability for 5mm Parts

V8ZA05(P)

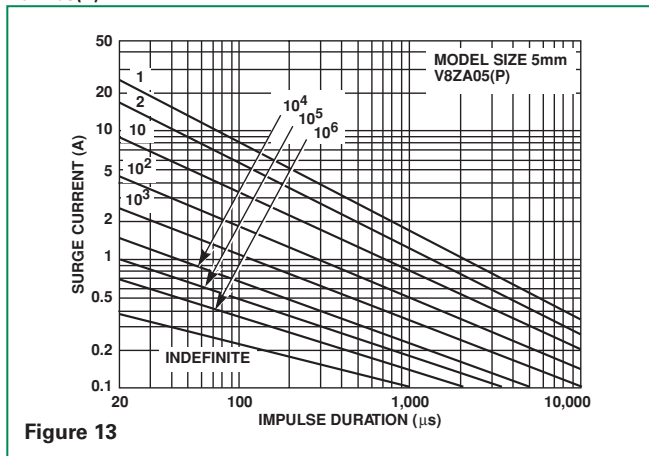


Figure 13

V12ZA05(P) - V68ZA05(P)

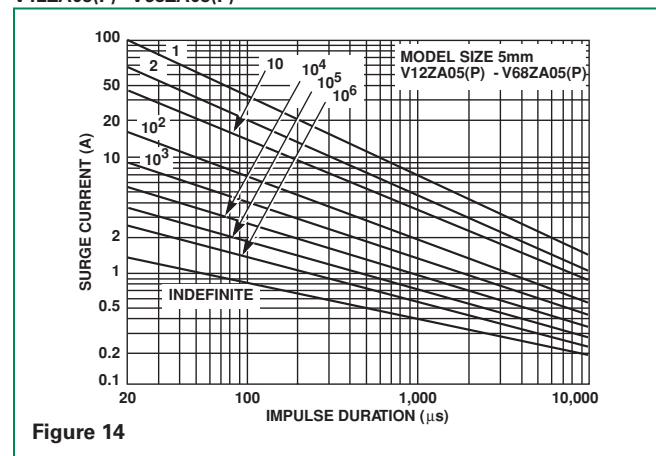


Figure 14

V82ZA05(P) - V750ZA05(P)

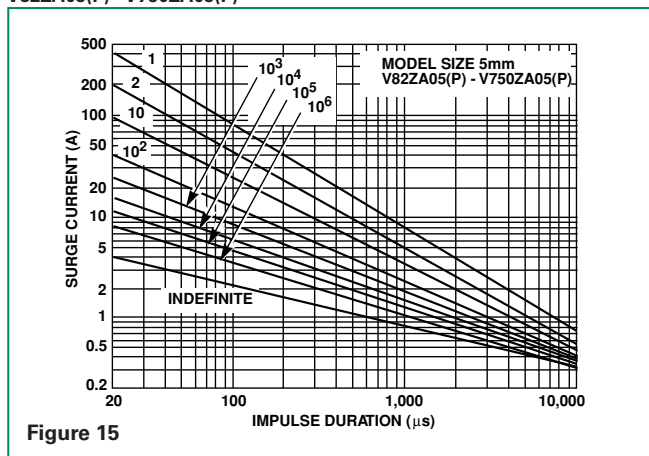
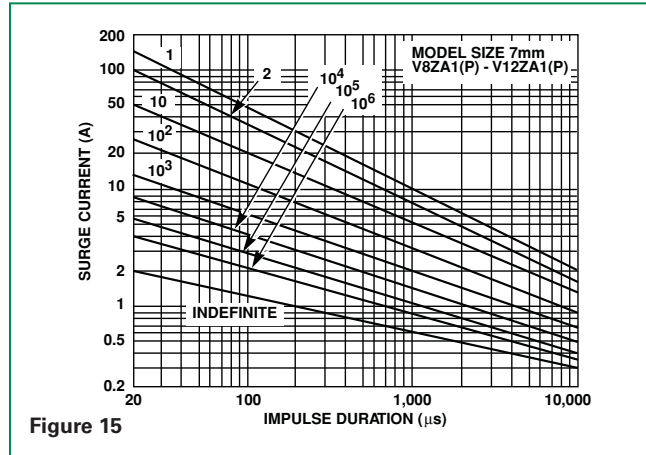


Figure 15



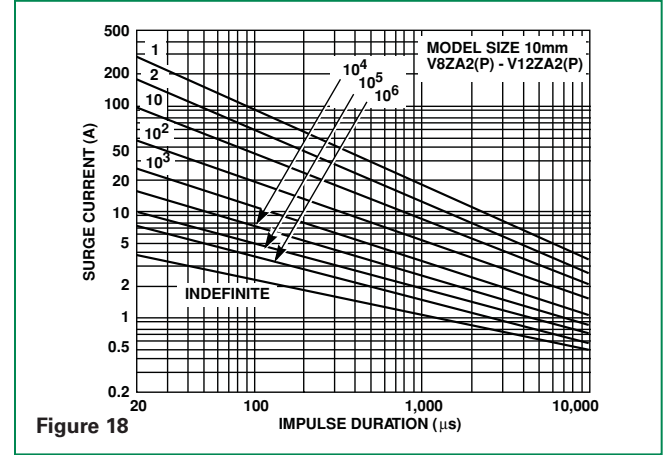
**Repetitive Surge Capability for 7mm Parts**

V8ZA1(P) - V12ZA1(P)

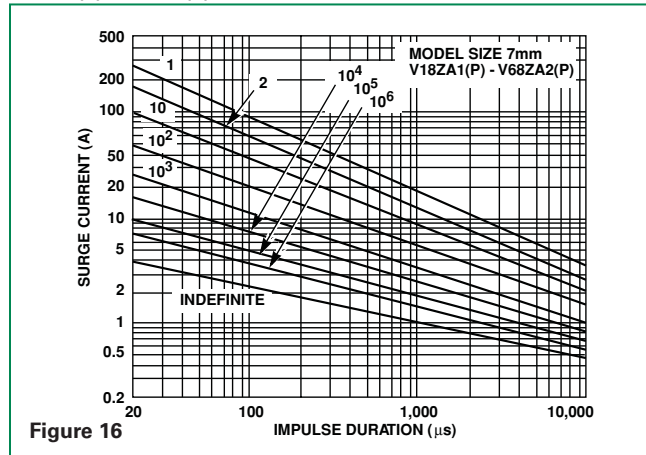


**Repetitive Surge Capability for 10mm Parts**

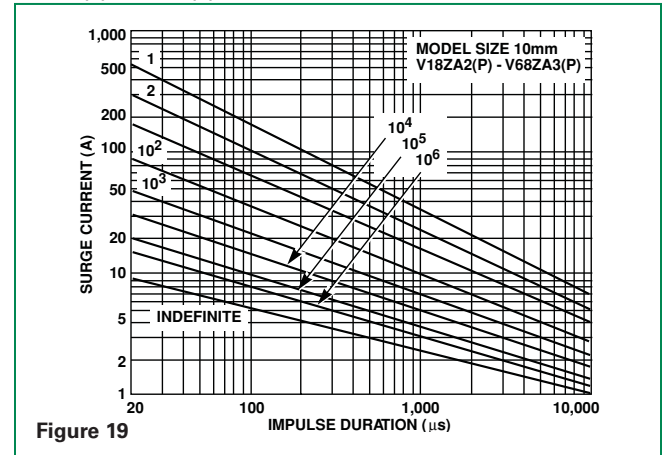
V8ZA2(P) - V127ZA2(P)



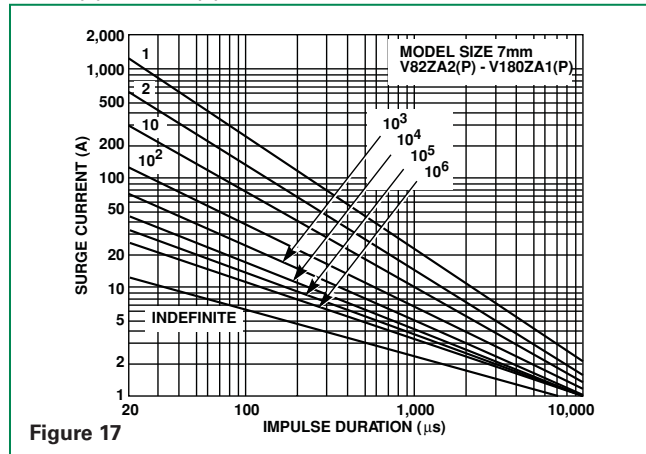
V18ZA1(P) - V68ZA2(P)



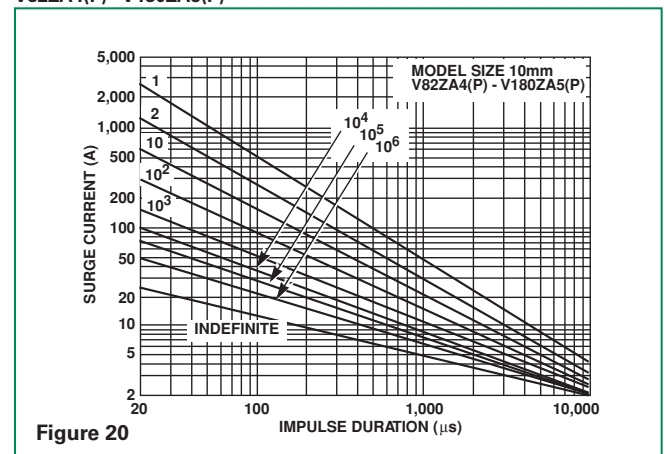
V18ZA2(P) - V68ZA3(P)



V82ZA2(P) - V180ZA1(P)



V82ZA4(P) - V180ZA5(P)



### Repetitive Surge Capability for 14mm Parts

V18ZA3(P) - V68ZA10(P)

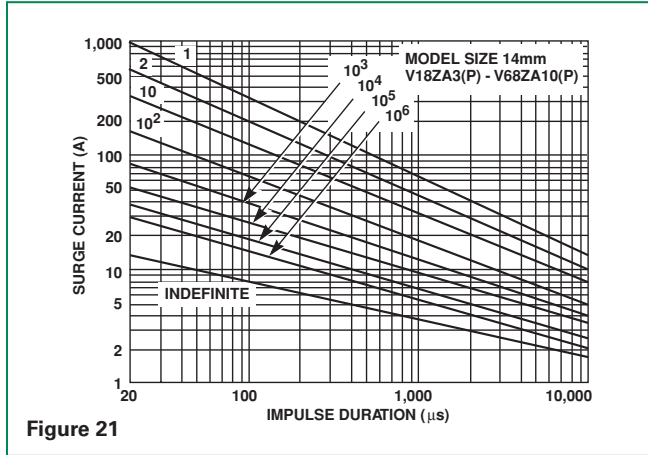


Figure 21

V82ZA12(P) - V180ZA10(P)

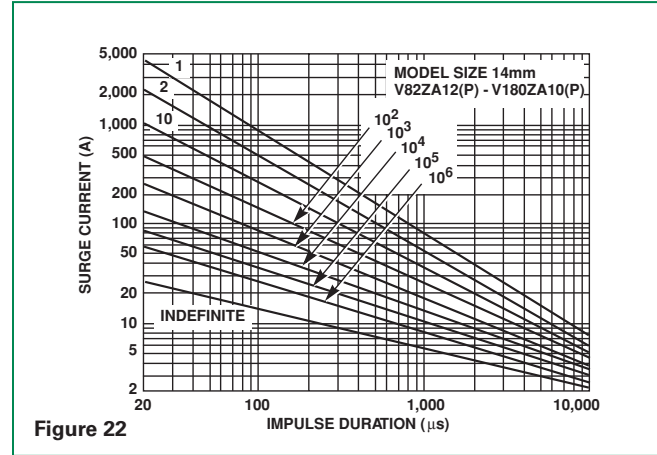


Figure 22

### Repetitive Surge Capability for 20mm Parts

V18ZA40(P) - V68ZA20(P)

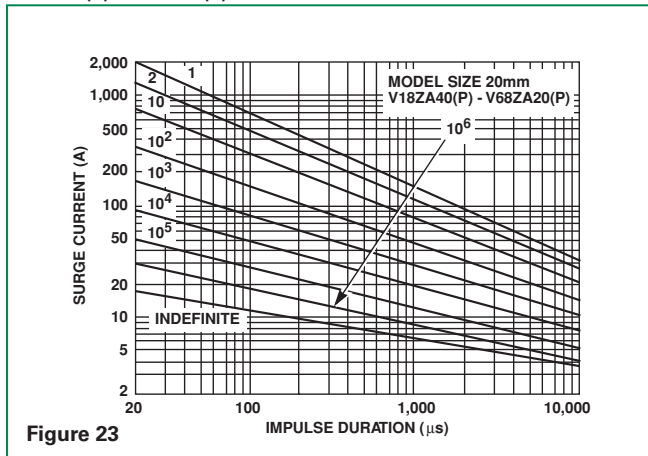


Figure 23

V120ZA20(P) - V180ZA20(P)

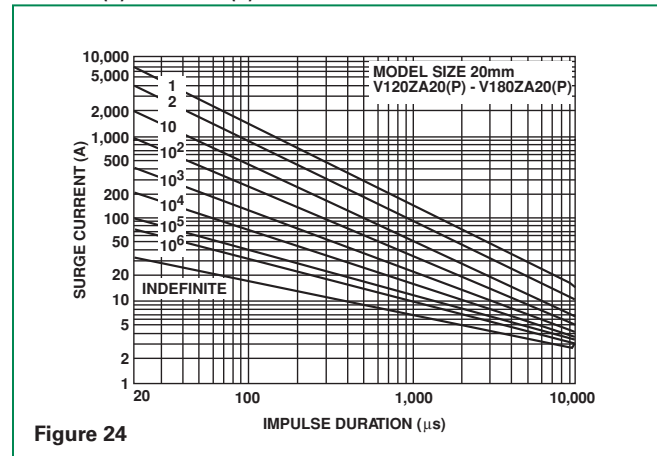


Figure 24

NOTE: If pulse ratings are exceeded, a shift of  $V_{NIDC}$  (at specified current) of more than +/-10% could result. This type of shift, which normally results in a decrease of  $V_{NIDC}$ , may result in the device not meeting the original published specifications, but does not prevent the device from continuing to function, and to provide ample protection.

**Wave Solder Profile**

**Non Lead-free Profile**

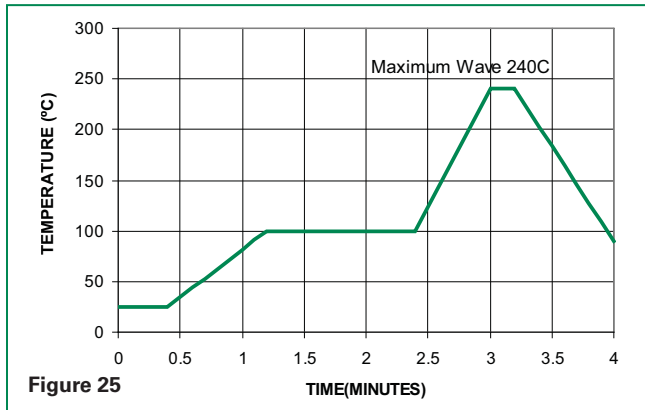


Figure 25

**Lead-free Profile**

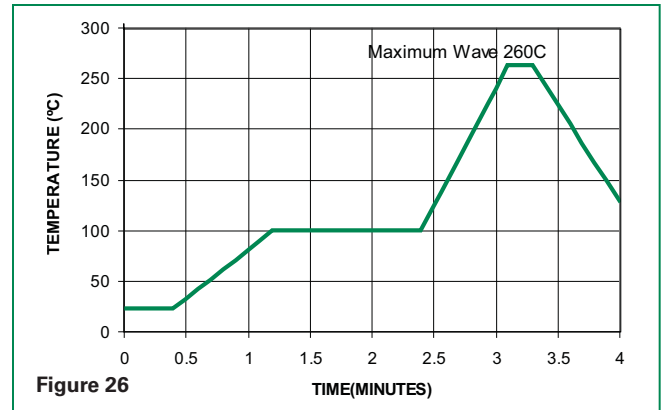


Figure 26

**Physical Specifications**

<b>Lead Material</b>	Tin-Coated Copper Wire
<b>Soldering Characteristics</b>	Solderability per MIL-STD-202, Method 208E
<b>Insulating Material</b>	Cured, flame retardant epoxy polymer meets UL94V-0 requirements
<b>Device Labeling</b>	Marked with LF, voltage, UL/CSA logos, and date code

**Environmental Specifications**

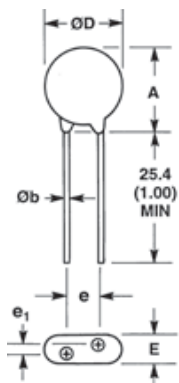
<b>Operating Ambient Temperature Range</b>	-55°C to +85°C
<b>Storage Temperature Range</b>	-55°C to +125°C
<b>Humidity Aging</b>	+85°C, 85% RH, 1000 hours +/-10% typical voltage change
<b>Thermal Shock</b>	+85°C to -40°C 10 times +/-10% typical voltage change
<b>Solvent Resistance</b>	MIL-STD-202, Method 215F
<b>Moisture Sensitivity</b>	Level 1, J-STD-020C

ZA Series

**ZA Series Varistors for Hi-Temperature Operating Conditions:**

- Phenolic coated ZA Series devices are available with improved maximum operating temperature of 125°C
- These devices also have improved temperature cycling performance capability
- Ratings and specifications are as per standard ZA Series except Hi-Pot Encapsulation (Isolation Voltage Capability) = 500V
- To order: add 'X1347' to part number (e.g. V22ZA3X1347)
- These devices are not UL, CSA, VDE or CECC certified
- Contact factory for further details

### Product Dimensions (mm)



#### CRIMPED AND TRIMMED LEAD

Radial lead types can be supplied with combination preformed crimp and trimmed leads. This option is supplied to the dimensions shown.

\*Seating plane interpretation per IEC-717

To order this crimped and trimmed lead style, standard radial type model numbers are changed by replacing the model letter "ZA" with "ZC." This option is supplied in bulk only.

Example:

Standard Model	Order As
V18ZA3	V18ZC3

For crimped leads without trimming and any variations to the above, contact Littelfuse.

Dimension	V <sub>RMS</sub> Voltage Model	5mm Size		7mm Size		10mm Size		14mm Size		20mm Size	
		Min. mm (in)	Max. mm (in)	Min. mm (in)	Max. mm (in)	Min. mm (in)	Max. mm (in)	Min. mm (in)	Max. mm (in)	Min. mm (in)	Max. mm (in)
<b>A</b>	All	-	10 (0.394)	-	12 (0.472)	-	16 (0.630)	-	20 (0.787)	-	26.5 (1.043)
<b>ØD</b>	All	-	7 (0.276)	-	9 (0.354)	-	12.5 (0.492)	-	17 (0.669)	-	23 (0.906)
<b>e</b> <small>(see notes below)</small>	All	4 (0.157)	6 (0.236)	4 (0.157)	6 (0.236)	6.5 (0.256)	8.5 (0.335)	6.5 (0.256)	8.5 (0.335)	6.5 (0.256) <small>(note 1 below)</small>	8.5 (0.335) <small>(note 1 below)</small>
<b>e<sub>1</sub></b>	V8ZA-V56ZA	1 (0.039)	3 (0.118)	1 (0.039)	3 (0.118)	1 (0.039)	3 (0.118)	1 (0.039)	3 (0.118)	1 (0.039)	3 (0.118)
	V68ZA-V100ZA	1.5 (0.059)	3.5 (0.138)	1.5 (0.059)	3.5 (0.138)	1.5 (0.059)	3.5 (0.138)	1.5 (0.059)	3.5 (0.138)	1.5 (0.059)	3.5 (0.138)
	V120ZA-V180ZA	1 (0.039)	3 (0.118)	1 (0.039)	3 (0.118)	1 (0.039)	3 (0.118)	1 (0.038)	3 (0.118)	1 (0.038)	3 (0.118)
	V205ZA-V750ZA	1.5 (0.059)	3.5 (0.138)	-	-	-	-	-	-	-	-
<b>E</b>	V8ZA-V56ZA	-	5 (0.197)	-	5 (0.197)	-	5 (0.197)	-	5 (0.197)	-	5 (0.197)
	V68ZA-V100ZA	-	5.6 (0.220)	-	5.6 (0.220)	-	5.6 (0.220)	-	5.6 (0.220)	-	5.6 (0.220)
	V120ZA-V180ZA	-	5 (0.197)	-	5 (0.197)	-	5 (0.197)	-	5 (0.197)	-	5 (0.197)
	V205ZA-V750ZA	-	5.6 (0.220)	-	-	-	-	-	-	-	-
<b>Øb</b>	All	0.585 (0.023)	0.685 (0.027)	0.585 (0.023)	0.685 (0.027)	0.76 (0.030)	0.86 (0.034)	0.76 (0.030)	0.86 (0.034)	0.76 (0.030)	0.86 (0.034)
<b>A</b>	All	-	13.0 (0.512)	-	15 (0.591)	-	19.5 (0.768)	-	22.5 (0.886)	-	29.0 (1.142)
<b>L<sub>TRIM</sub></b>	All	2.41 (0.095)	4.69 (0.185)	2.41 (0.095)	4.69 (0.185)	2.41 (0.095)	4.69 (0.185)	2.41 (0.095)	4.69 (0.185)	2.41 (0.095)	4.69 (0.185)

NOTES: Dimensions in millimeters, inches in parentheses.

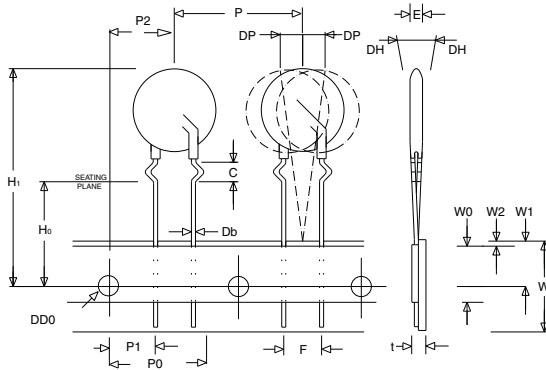
1. For 20mm size devices, a 10mm "e" dimension option is also available. Please refer to "Ordering Notes" section "X10" option code for additional information.
2. V24ZA50(P) and V24ZC50(P) only supplied with lead spacing of 6.35mm +/-0.5mm (0.25 +/-0.0196) Dimension e = 5.85 min. Does not apply to Tape and Reel parts.

**Tape and Reel Specifications**

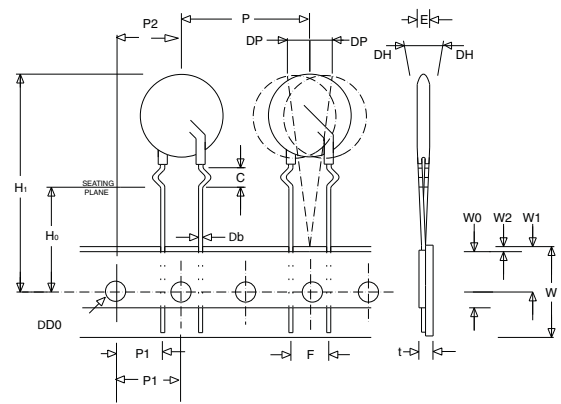
**5 and 7mm Devices**

**10, 14 and 20mm Devices**

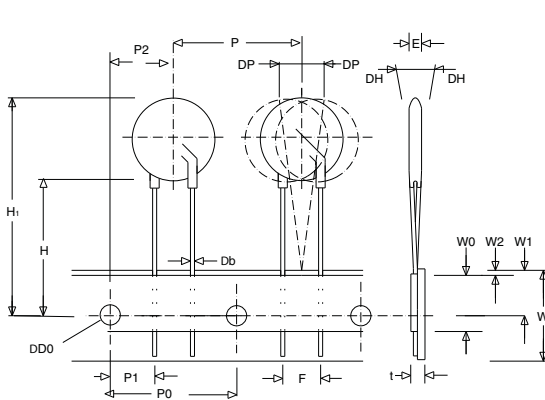
**CRIMPED LEADS "ZT"**



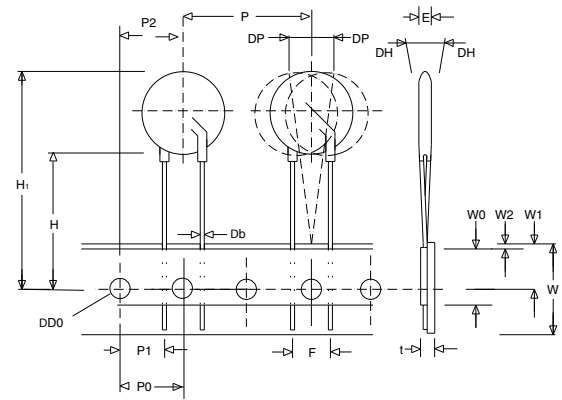
**CRIMPED LEADS "ZT"**



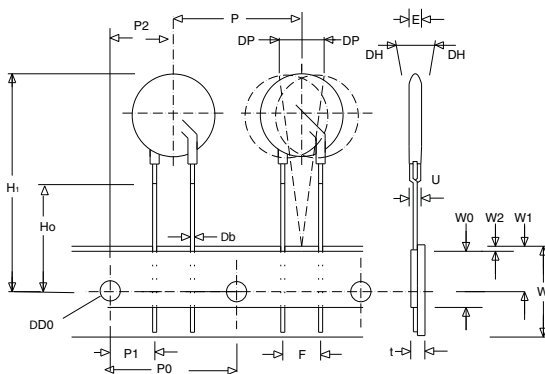
**STRAIGHT LEADS "ZS"**



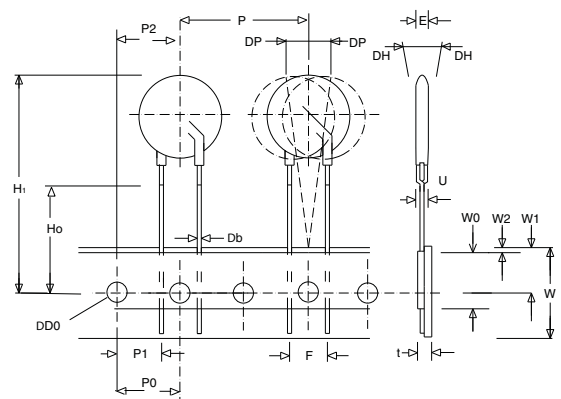
**STRAIGHT LEADS "ZS"**



**UNDER CRIMPED LEADS "ZU"**



**UNDER CRIMPED LEADS "ZU"**



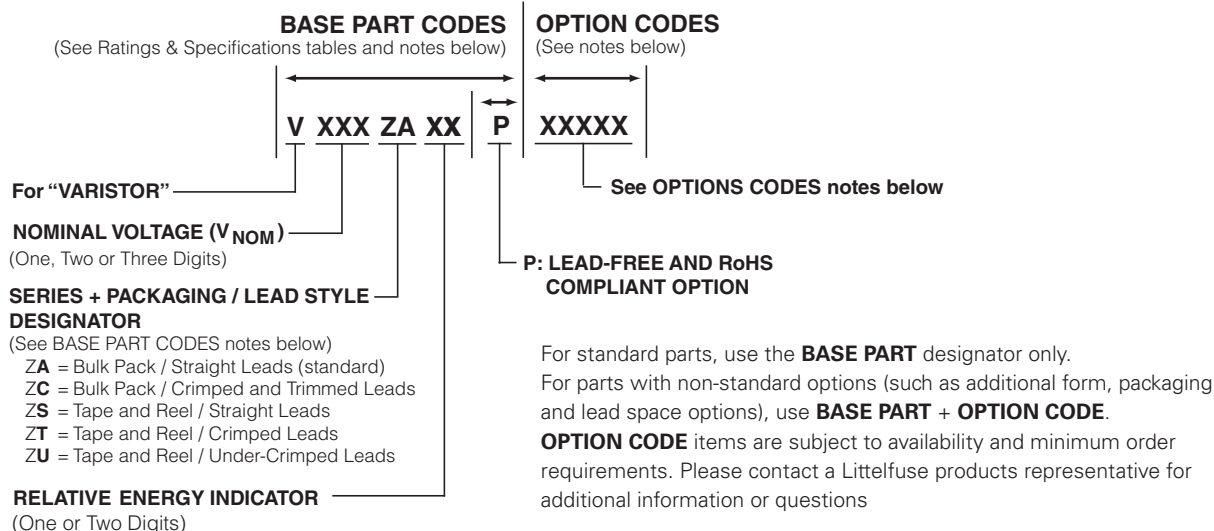
### Tape and Reel Specifications

- Conforms to ANSI and EIA specifications
- Can be supplied to IEC Publication 286-2
- Radial devices on tape are supplied with crimped leads, straight leads, or under-crimped leads
- 5mm parts are available on tape and reel up to 385 VAC only

NOTE: Leads are offset by Dim e1

SYMBOL	DESCRIPTION	MODEL SIZE				
		5mm	7mm	10mm	14mm	20mm
<b>P</b>	Pitch of Component	12.7 +/- 1.0	12.7 +/- 1.0	25.4 +/- 1.0	25.4 +/- 1.0	25.4 +/- 1.0
<b>P<sub>0</sub></b>	Feed Hole Pitch	12.7 +/- 0.2	12.7 +/- 0.2	12.7 +/- 0.2	12.7 +/- 0.2	12.7 +/- 0.2
<b>P<sub>1</sub></b>	Feed Hole Center to Pitch	3.85 +/- 0.7	3.85 +/- 0.7	8.85 +/- 0.7	8.85 +/- 0.7	8.85 +/- 0.7
<b>P<sub>2</sub></b>	Hole Center to Component Center	6.35 +/- 1.0	6.35 +/- 1.0	12.7 +/- 0.7	12.7 +/- 0.7	12.7 +/- 0.7
<b>F</b>	Lead to Lead Distance	5.0 +/- 1.0	5.0 +/- 1.0	7.5 +/- 1.0	7.5 +/- 1.0	7.5 +/- 1.0
<b>h</b>	Component Alignment	2.0 Max	2.0 Max	2.0 Max	2.0 Max	2.0 Max
<b>W</b>	Tape Width	18.0 +1.0 / -0.5	18.0 +1.0 / -0.5	18.0 +1.0 / -0.5	18.0 +1.0 / -0.5	18.0 +1.0 / -0.5
<b>W<sub>0</sub></b>	Hold Down Tape Width	12.0 +/- 0.3	12.0 +/- 0.3	12.0 +/- 0.3	12.0 +/- 0.3	12.0 +/- 0.3
<b>W<sub>1</sub></b>	Hole Position	9.0 +0.75 / -0.50	9.0 +0.75 / -0.50	9.0 +0.75 / -0.50	9.0 +0.75 / -0.50	9.0 +0.75 / -0.50
<b>W<sub>2</sub></b>	Hold Down Tape Position	0.5 Max	0.5 Max	0.5 Max	0.5 Max	0.5 Max
<b>H</b>	Height from Tape Center to Component Base	18.0 +2.0 / -0.0	18.0 +2.0 / -0.0	18.0 +2.0 / -0.0	18.0 +2.0 / -0.0	18.0 +2.0 / -0.0
<b>H<sub>0</sub></b>	Seating Plane Height	16.0 +/- 0.5	16.0 +/- 0.5	16.0 +/- 0.5	16.0 +/- 0.5	16.0 +/- 0.5
<b>H<sub>1</sub></b>	Component Height	29.0 Max	32.0 Max	36.0 Max	40.0 Max	46.5 Max
<b>D<sub>0</sub></b>	Feed Hole Diameter	4.0 +/- 0.2	4.0 +/- 0.2	4.0 +/- 0.2	4.0 +/- 0.2	4.0 +/- 0.2
<b>t</b>	Total Tape Thickness	0.7 +/- 0.2	0.7 +/- 0.2	0.7 +/- 0.2	0.7 +/- 0.2	0.7 +/- 0.2
<b>U</b>	Undercrimp Width	8.0 Max	8.0 Max	8.0 Max	8.0 Max	8.0 Max
<b>p</b>	Component Alignment	3° Max	3° Max	3° Max	3° Max	3° Max

**Part Numbering System**



**Ordering Notes:**

**BASE PART CODES:**

**Series + Packaging / Lead Style Designators:**

Ordering examples:

Straight Lead Bulk Pack (standard)	Straight Lead Tape & Reel	Crimped Lead Tape & Reel	Crimped & Trimmed Lead Bulk Pack	Under-Crimp Lead Tape & Reel
V18ZA3	V18ZS3	V18ZT3	V18ZC3	V18ZU3

Crimped lead ZA Series varistors are supplied standard in tape and reel, denoted with "ZT."

"ZC" style is supplied in bulk only.

"ZU" style is supplied in tape and reel only.

For crimped leads without trimming and any variations other than that described above, please contact Littelfuse.

**Lead-free / RoHS Designator:**

For Lead-free and RoHS compliant parts add "P" after the BASE PART number and before any other OPTION CODE:

Standard Model	Order As
V18ZA40	V18ZA40P

Standard Model with Option	Order As
V18ZA40X10	V18ZA40PX10

**OPTION CODES:**

**X10:** 10MM LEAD SPACING OPTION –

For 10 +/-1 mm (0.394-/+0.039 in) lead spacing (available on 20mm diameter models only), append standard model BASE PART number with "X10." Example:

Standard Model	Order As
V18ZA40	V18ZA40X10

**X2855:** Nickel Barrier COATED WIRE OPTION –

All standard parts use Tin-Coated Copper wire. Nickel Barrier Coated wire is available as an option, consisting of Copper wire with a flashing of Nickel followed by a top coating of Tin. To order append standard model BASE PART number with "X2855." Example:

Standard Model	Order As
V18ZA40	V18ZA40X2855

**TAPE & REEL QUANTITIES:**

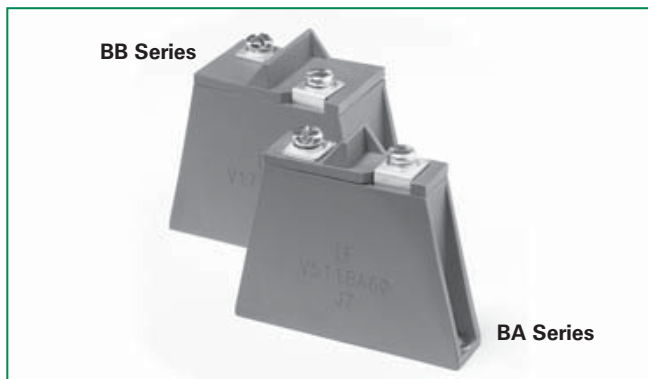
Littelfuse ZA Series varistors are shipped standard in bulk pack with straight leads and lead spacing outlined in the Package Dimensions section of this data sheet. Contact your Littelfuse sales representative to discuss non-standard options.

Device Size	Voltage	Quantity Per Reel		
		"S" Reel	"T" Reel	"U" Reel
5mm	All	1000	1000	1000
7mm	All	1000	1000	1000
10mm	All	500	500	500
14mm	< 300V	500	500	500
20mm	< 300V	500	500	400





RoHS **BA/BB Varistor Series**



**Description**

The BA and BB Series transient surge suppressors are heavy-duty industrial Metal-Oxide Varistors (MOVs) designed to provide surge protection for motor controls and power supplies used in oil-drilling, mining, transportation equipment and other heavy industrial AC line applications.

These UL- recognized varistors have similar package construction but differ in size and ratings. The BA models are rated from 130 to 880V<sub>M(AC)</sub>. The BB models from 1100 to 2800V<sub>M(AC)</sub>.

Both the BA and BB Series feature improved creep and strike capability to minimize breakdown along the package surface, a package design that provides complete electrical isolation of the disc subassembly, and rigid terminals to ensure secure wire contacts.

See BA/BB Series Device Ratings and Specifications Table for part number and brand information.

**Agency Approvals**

Agency	Agency File Number
	E320116 - for BA Series only.

**Features**

- RoHS compliant and Lead-free available
- High energy absorption capability  $W_{TM}$   
BA Series 3200J  
BB Series 10,000J
- Wide operating voltage range  $V_{M(AC)RMS}$   
BA Series 130V to 880V  
BB Series 1100V to 2800V
- Rigid terminals for secure wire contact
- Case design provides complete electrical isolation of disc subassembly
- Littelfuse largest packaged disc 60mm diameter
- No derating up to 85°C ambient

**Absolute Maximum Ratings**

• For ratings of individual members of a series, see Device Ratings and Specifications chart

Continuous	BA Series	BB Series	Units
<b>Steady State Applied Voltage:</b>			
AC Voltage Range ( $V_{M(AC)RMS}$ )	130 to 880	1100 to 2800	V
DC Voltage Range ( $V_{M(DC)}$ )	175 to 1150	1400 to 3500	V
<b>Transients:</b>			
Peak Pulse Current ( $I_{TM}$ )			
For 8/20µs Current Wave (See Figure 2)	50,000 to 70,000	70,000	A
Single Pulse Energy Range			
For 2ms Current Squarewave ( $W_{TM}$ )	450 to 3200	3800 to 10000	J
Operating Ambient Temperature Range ( $T_A$ )	-55 to +85	-55 to +85	°C
Storage Temperature Range ( $T_{STG}$ )	-55 to +125	-55 to +125	°C
Temperature Coefficient (a <sup>v</sup> ) of Clamping Voltage ( $V_C$ ) at Specified Test Current	<0.01	<0.01	%/°C
Hi-Pot Encapsulation (COATING Isolation Voltage Capability) (Dielectric must withstand indicated DC voltage for one minute per MIL-STD-202, Method 301)	5000	5000	V
COATING Insulation Resistance	1000	1000	MΩ

**CAUTION:** Stresses above those listed in "Absolute Maximum Ratings" may cause permanent damage to the device. This is a stress only rating and operation of the device at these or any other conditions above those indicated in the operational sections of this specification is not implied.

### BA/BB Series Ratings & Specifications

Part Number	Maximum Rating (85°C)				Specifications (25°C)				
	Continuous		Transient		Varistor Voltage at 1mA DC Test Current			Maximum Clamping Volt $V_C$ at 200A Current (8/20 $\mu$ s)	Typical Capacitance $f = 1$ MHz
	$V_{RMS}$	$V_{DC}$	Energy (2ms)	Peak Current $8 \times 20\mu s$					
	$V_{M(AC)}$	$V_{M(DC)}$	$W_{TM}$	$I_{TM}$	Min	$V_{N(DC)}$	Max	$V_C$	C
(V)	(V)	(J)	(A)	(V)	(V)	(V)	(V)	(pF)	
<b>BA Series</b>									
V131BA60	130	175	450	50000	184	200	228	340	20000
V151BA60	150	200	530	50000	212	240	268	400	16000
V251BA60	250	330	880	50000	354	390	429	620	10000
V271BA60	275	369	950	50000	389	430	473	680	9000
V321BA60	320	420	1100	50000	462	510	561	760	7500
V421BA60	420	560	1500	70000	610	680	748	1060	6000
V481BA60	480	640	1600	70000	670	750	825	1160	5500
V511BA60	510	675	1800	70000	735	820	910	1300	5000
V571BA60	575	730	2100	70000	805	910	1000	1420	4500
V661BA60	660	850	2300	70000	940	1050	1160	1640	4000
V751BA60	750	970	2600	70000	1080	1200	1320	1880	3500
V881BA60	880	1150	3200	70000	1290	1500	1650	2340	2700
<b>BB Series</b>									
V112BB60	1100	1400	3800	70000	1620	1800	2060	2940	2200
V142BB60	1400	1750	5000	70000	2020	2200	2550	3600	1800
V172BB60	1700	2150	6000	70000	2500	2700	3030	4300	1500
V202BB60	2000	2500	7500	70000	2970	3300	3630	5200	1200
V242BB60	2400	3000	8600	70000	3510	3900	4290	6200	1000
V282BB60	2800	3500	10000	70000	4230	4700	5170	7400	800

NOTE: Average power dissipation of transients not to exceed 2.5W. See Figures 3 and 4 for more information on power dissipation.

**Power Dissipation Ratings**

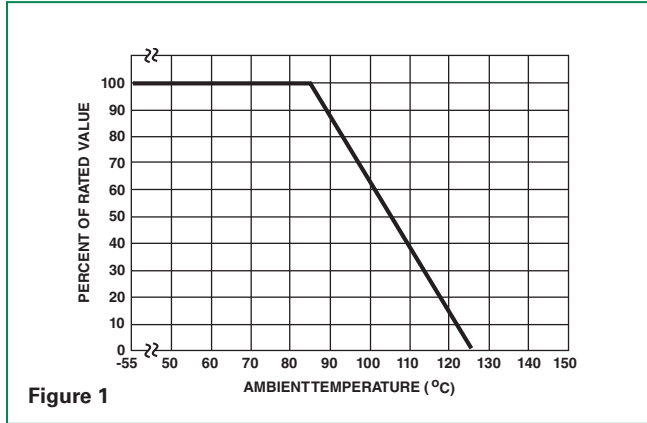


Figure 1

Should transients occur in rapid succession, the average power dissipation required is simply the energy (watt-seconds) per pulse times the number of pulses per second. The power so developed must be within the specifications shown on the Device Ratings and Characteristics Table for the specific device. Furthermore, the operating values need to be derated at high temperatures as shown in the above diagram. Because varistors can only dissipate a relatively small amount of average power they are, therefore, not suitable for repetitive applications that involve substantial amounts of average power dissipation.

**Peak Pulse Current Test Waveform**

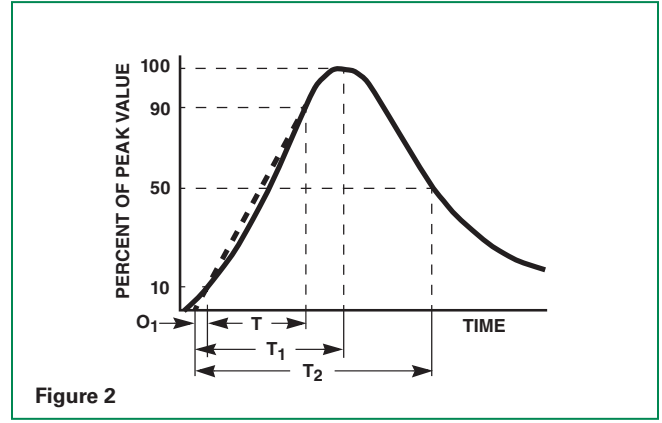


Figure 2

$O_1$  = Virtual Origin of Wave  
 $T$  = Time from 10% to 90% of Peak  
 $T_1$  = Rise Time =  $1.25 \times T$   
 $T_2$  = Decay Time

**Example** - For an  $8/20 \mu s$  Current Waveform:

$8 \mu s = T_1 = \text{Rise Time}$   
 $20 \mu s = T_2 = \text{Decay Time}$

**Stand by Power Dissipation vs Applied  $V_{RMS}$  at Varied Temperatures**

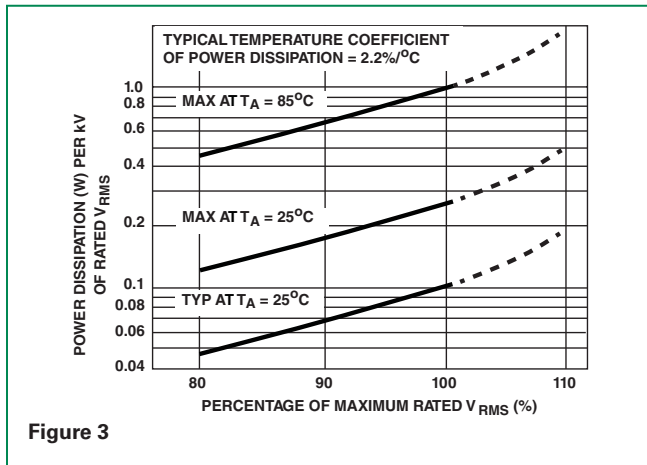


Figure 3

**Typical Stability of Standby Power Dissipation at Rated  $V_{RMS}$  vs Time**

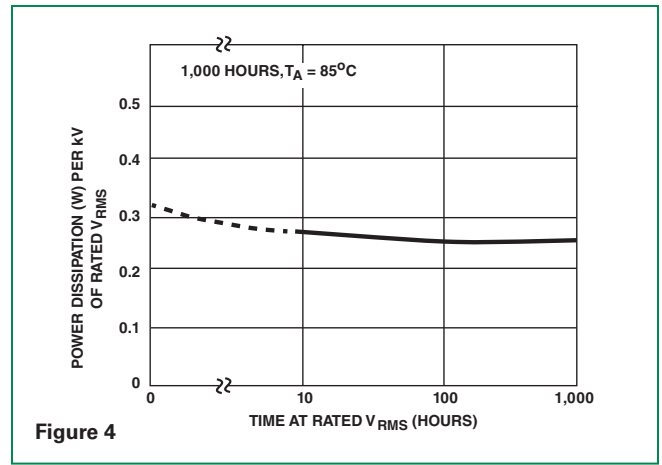


Figure 4

BA/BB Series

### Maximum Clamping Voltage BA Series

V131BA60 - V881BA60

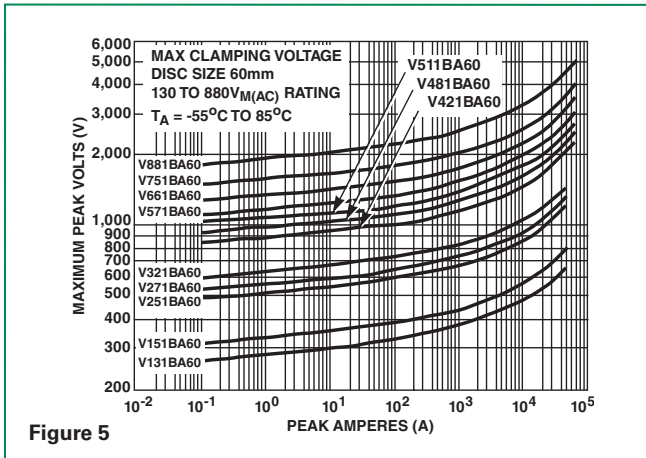


Figure 5

### Maximum Clamping Voltage BB Series

V112BB60 - V282BB60

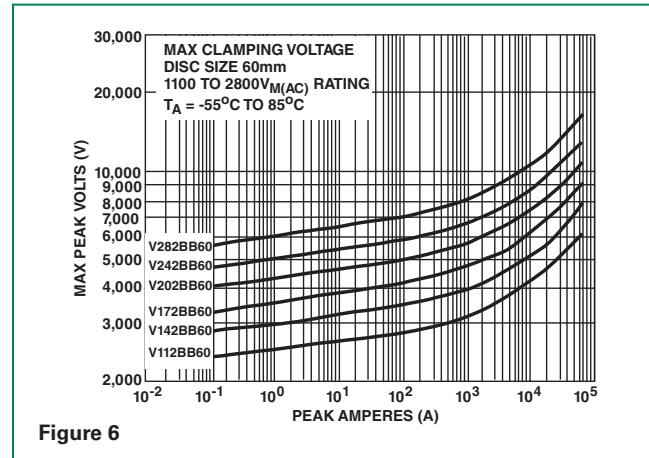


Figure 6

### Repetitive Surge Capability BA Series

V131BA60 - V321BA60

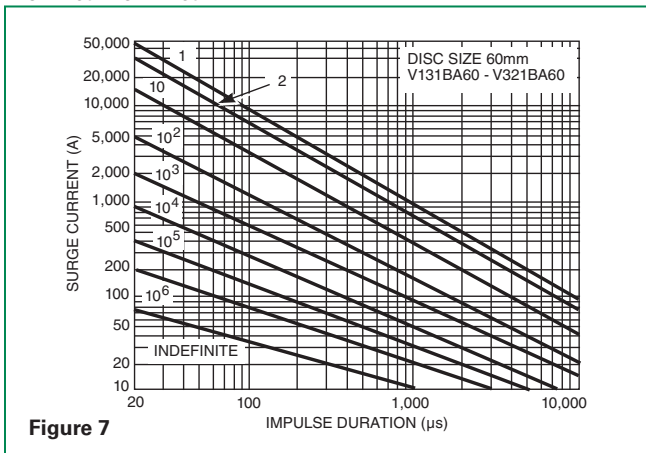


Figure 7

### Repetitive Surge Capability BB Series

V421BA60 - V282BB60

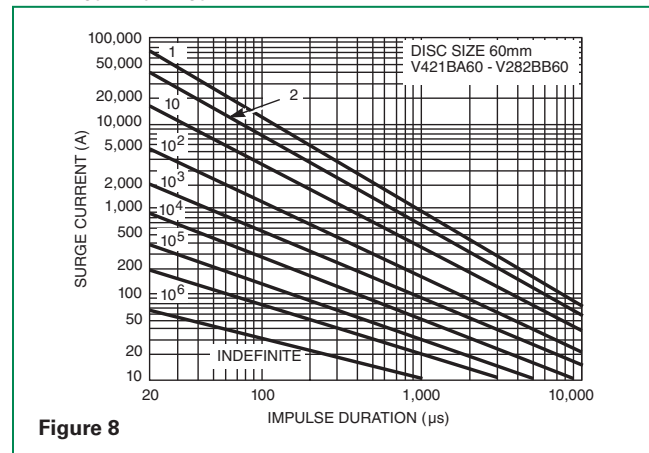


Figure 8

NOTE: If pulse ratings are exceeded, a shift of  $V_{cl}(DC)$  (at specified current) of more than +/-10% could result. This type of shift, which normally results in a decrease of  $V_{cl}(DC)$ , may result in the device not meeting the original published specifications, but it does not prevent the device from continuing to function, and to provide ample protection.

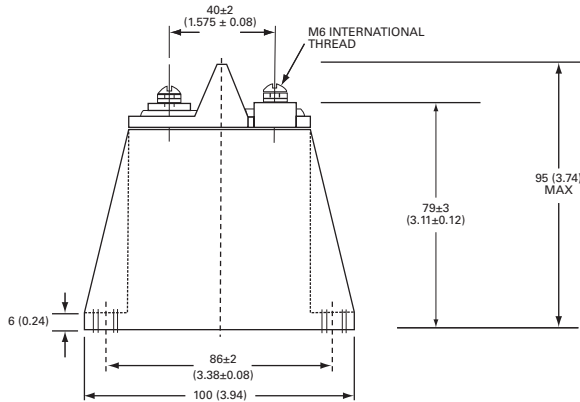
### Physical Specifications

<b>Lead Material</b>	BA / BB – Copper with Tin Plating
<b>Insulating Material</b>	Cured, flame retardant epoxy polymer meets UL94V-0 requirements.
<b>Device Labeling</b>	Marked with LF, Part Number and Date code

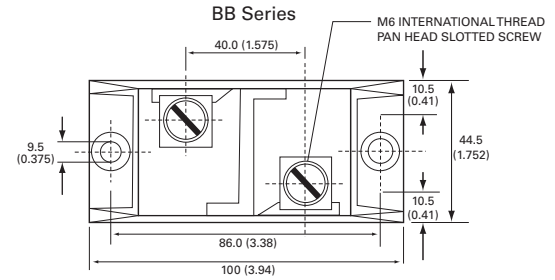
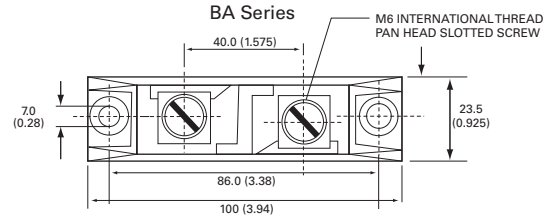
### Environmental Specifications

<b>Operating/Storage Temperature</b>	-55°C to +85°C/ -55°C to +125°C
<b>Humidity Aging</b>	+85°C, 85% RH, 1000 hours +/- 5% typical resistance change
<b>Thermal Shock</b>	+85°C to -40°C 10 times +/- 5% typical resistance change
<b>Solvent Resistance</b>	MIL-STD-202, Method 215F
<b>Moisture Sensitivity</b>	Level 1, J-STD-020C

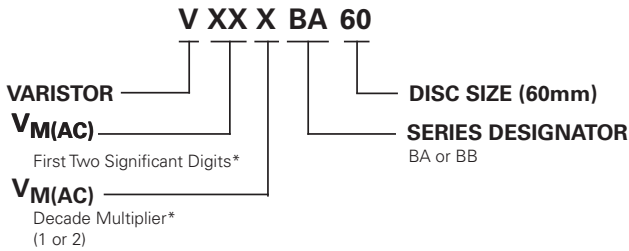
**Dimensions**



Notes:  
Typical weight: BA Series:250g and BB Series: 600g  
Dimensions are in mm; inches in parentheses for reference only.



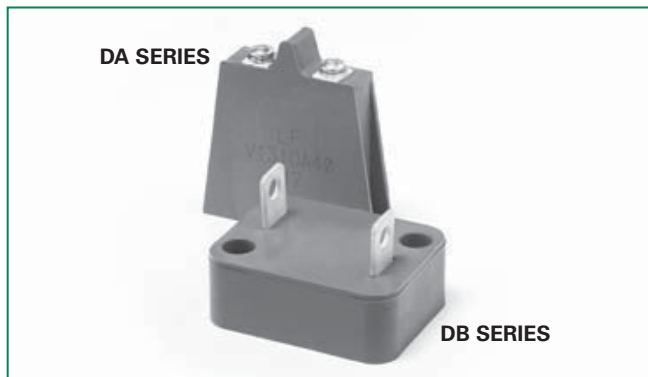
**Part Numbering System**



\*Refer to Rating & Specifications table  
Examples:  
130 V<sub>M(AC)</sub> = 131  
2800 V<sub>M(AC)</sub> = 282





**RoHS (Pb) DA/DB Varistor Series**

**Description**

The DA and DB Series transient surge suppressors are heavy-duty industrial Metal-Oxide Varistors (MOVs) designed to provide surge protection for motor controls and power supplies used in oil-drilling, mining, and transportation equipment.

These UL recognized varistors have identical ratings and specifications but differ in case construction to provide flexibility in equipment designs.

DA Series devices feature rigid terminals to ensure secure wire contacts. Both the DA and DB Series feature improved creep and strike distance capability to minimize breakdown along the package surface design that provides complete electrical isolation of the disc subassembly.

See DA/DB Series Device Ratings and Specifications table for part number and brand information.

**Agency Approvals**

Agency	Agency File Number
	E320116

**Features**

- RoHS compliant and Lead-free
- High energy absorption capability  $W_{TM}$  up to 1050J
- Wide operating voltage range  $V_{M(AC)RMS}$  130V to 750V
- Screw terminals (DA Series), quick connect push-on connectors (DB Series)
- Case design provides complete electrical isolation of disc subassembly
- 40mm diameter disc
- No derating up to 85°C ambient

**Absolute Maximum Ratings**

• For ratings of individual members of a series, see Device Ratings and Specifications chart

Continuous	DA/DB Series	Units
Steady State Applied Voltage:		
AC Voltage Range ( $V_{M(AC)RMS}$ )	130 to 750	V
DC Voltage Range ( $V_{M(DC)}$ )	175 to 970	V
Transients:		
Peak Pulse Current ( $I_{TM}$ )		
For 8/20 $\mu$ s Current Wave (See Figure 2)	40,000	A
Single Pulse Energy Range		
For 2ms Current Squarewave ( $W_{TM}$ )	270 to 1050	J
Operating Ambient Temperature Range ( $T_A$ )	-55 to +85	°C
Storage Temperature Range ( $T_{STG}$ )	-55 to +125	°C
Temperature Coefficient ( $\alpha^V$ ) of Clamping Voltage ( $V_C$ ) at Specified Test Current	<0.01	%/°C
Hi-Pot Encapsulation (COATING Isolation Voltage Capability) (Dielectric must withstand indicated DC voltage for one minute per MIL-STD 202, Method 301)	5000	V
COATING Insulation Resistance	1000	M $\Omega$

**CAUTION:** Stresses above those listed in "Absolute Maximum Ratings" may cause permanent damage to the device. This is a stress only rating and operation of the device at these or any other conditions above those indicated in the operational sections of this specification is not implied.

### DA/DB Series Ratings & Specifications

Part Number Device Branding		Maximum Rating (85°C)				Specifications (25°C)				
		Continuous		Transient		Varistor Voltage at 1mA DC Test Current			Maximum Clamping Volt $V_C$ at 200A Current (8/20 $\mu$ s)	Typical Capaci- tance $f =$ 1MHz
		$V_{RMS}$	$V_{DC}$	Energy (2ms)	Peak Current 8 x 20 $\mu$ s					
DA	DB	$V_{M(AC)}$ (V)	$V_{M(DC)}$ (V)	$W_{TM}$ (J)	$I_{TM}$ (A)	(V)	(V)	(V)	$V_C$ (A)	C (pF)
V131DA40	V131DB40	130	175	270	40000 <sup>1</sup>	184	200	228	345	10000
V151DA40	V151DB40	150	200	300	40000 <sup>2</sup>	212	240	268	405	8000
V251DA40	V251DB40	250	330	370	40000	354	390	429	650	5000
V271DA40	V271DB40	275	369	400	40000	389	430	473	730	4500
V321DA40	V321DB40	320	420	460	40000	462	510	561	830	3800
V421DA40	V421DB40	420	560	600	40000	610	680	748	1130	3000
V481DA40	V481DB40	480	640	650	40000	670	750	825	1240	2700
V511DA40	V511DB40	510	675	700	40000	735	820	910	1350	2500
V571DA40	V571DB40	575	730	770	40000	805	910	1000	1480	2200
V661DA40	V661DB40	660	850	900	40000	940	1050	1160	1720	2000
V751DA40	V751DB40	750	970	1050	40000	1080	1200	1320	2000	1800

Note : Average power dissipation of transients not to exceed 2.0W.

### Power Dissipation Ratings

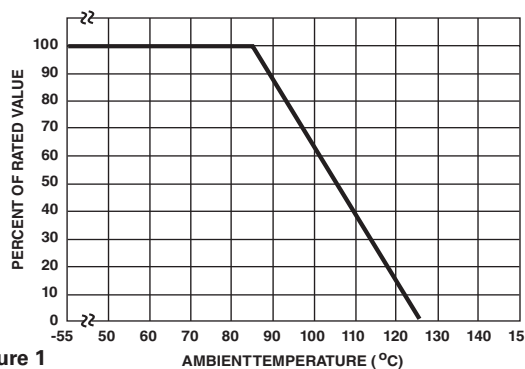


Figure 1

NOTES:

1. Peak current Applies to applications rated up to 115VRMS. Peak current is 30kA for applications greater than 115V.
2. Peak current applies to applications rated up to 132VRMS. Peak Current is 30kA for applications greater than 132V.

Should transients occur in rapid succession, the average power dissipation required is simply the energy (watt- seconds) per pulse times the number of pulses per second. The power so developed must be within the specifications shown on the Device Ratings and Specifications table for the specific device. Furthermore, the operating values need to be derated at high temperatures as shown above. Because varistors can only dissipate a relatively small amount of average power they are, therefore, not suitable for repetitive applications that involve substantial amounts of average power dissipation.

### Peak Pulse Current Test Waveform

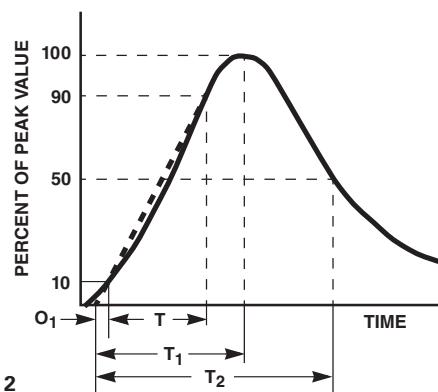


Figure 2

- $O_1$  = Virtual Origin of Wave
- $T$  = Time from 10% to 90% of Peak
- $T_1$  = Rise Time = 1.25 x  $T$
- $T_2$  = Decay Time

**Example** - For an 8/20  $\mu$ s Current Waveform:

- $8\mu s = T_1 =$  Rise Time
- $20\mu s = T_2 =$  Decay Time

**Maximum Clamping Voltage**

V131DA40 - V751DA40 and V131DB40 - V751DB40

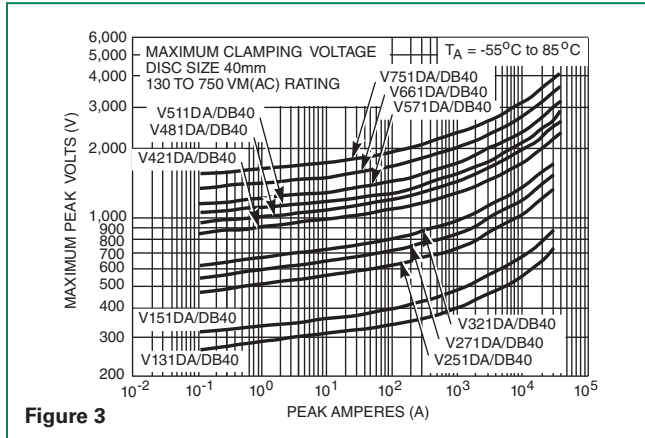


Figure 3

NOTE: If pulse ratings are exceeded, a shift of  $V_{NIDCI}$  (at specified current) of more than +/-10% could result. This type of shift, which normally results in a decrease of  $V_{NIDCI}$ , may result in the device not meeting the original published specifications, but it does not prevent the device from continuing to function, and to provide ample protection.

**Repetitive Surge Capability**

V131DA40 - V751DA40 and V131DB40 - V751DB40

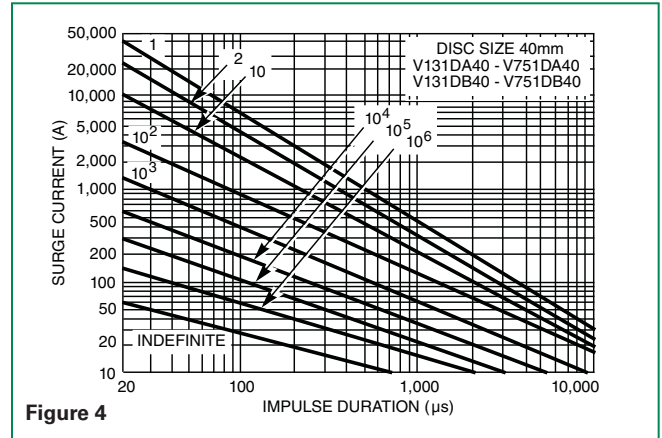


Figure 4

**Physical Specifications**

<b>Lead Material</b>	DA - Copper, Tin-plated DB - Brass, Tin-plated
<b>Insulating Material</b>	Cured, flame retardant epoxy polymer meets UL94V-0 requirements.
<b>Device Labeling</b>	Marked with LF, part number and date code

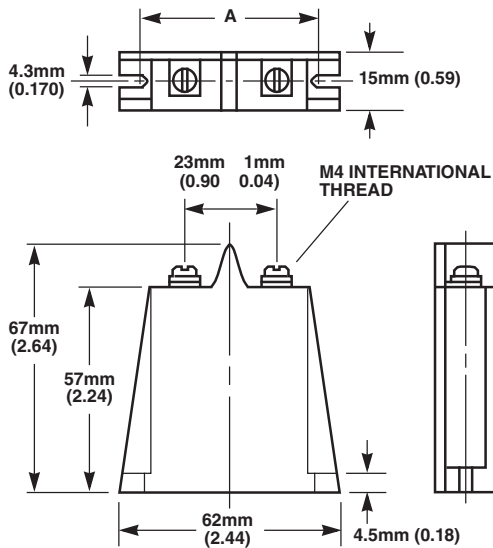
**Environmental Specifications**

<b>Operating/Storage Temperature</b>	-55°C to +85°C / -55°C to +125°C
<b>Humidity Aging</b>	+85°C, 85% RH, 1000 hours +/- 5% typical resistance change
<b>Thermal Shock</b>	+85°C to -40°C 10 times +/- 5% typical resistance change
<b>Solvent Resistance</b>	MIL-STD-202, Method 215F
<b>Moisture Sensitivity</b>	Level 1, J-STD-020C

### Product Dimensions (mm)

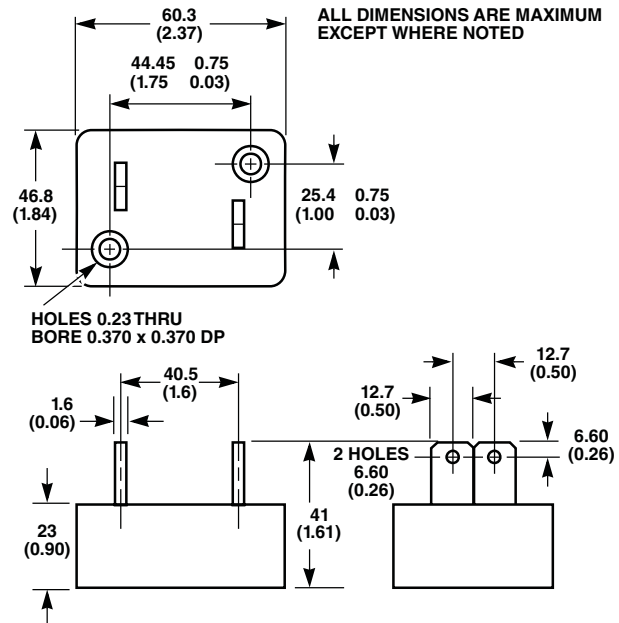
#### DA SERIES

"A" DIMENSION:  
 FILISTER HEAD SCREW - 51mm (2.01)  
 PAN HEAD SCREW - 53mm (2.09)



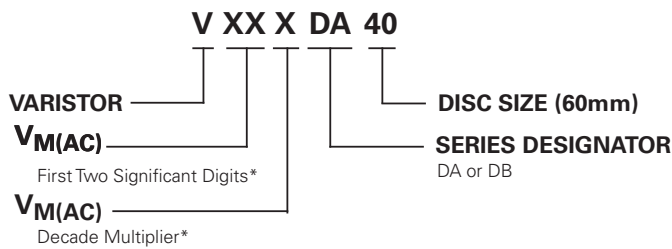
#### DB SERIES

ALL DIMENSIONS ARE MAXIMUM EXCEPT WHERE NOTED



Dimensions in millimeters and (inches).

### Part Numbering System



\*Refer to Rating & Specifications table  
 Example:  
 130 V<sub>M(AC)</sub> = 131

RoHS  **HA Varistor Series**





**Description**

HA Series transient surge suppressors are industrial high energy Metal-Oxide Varistors (MOVs). They are designed to provide secondary surge protection in the outdoor and service entrance environment (distribution panels) of buildings, and also in industrial applications for motor controls and power supplies used in the oil-drilling, mining, and transportation fields.

The design of the HA Series of MOVs provide rigid terminals for screw mounting. Also available in a clipped lead version for through hole board placement or to accommodate soldered leads designation "HC."

See Ratings and Specifications Table for part number and brand information.

**Agency Approvals**

Agency	Agency File Number
	E320116
	LR91788

**Features**

- RoHS compliant and Lead-free
- Wide operating voltage range  
 $V_{M(AC)RMS}$   
110V to 750V
- Two disc sizes available  
32mm and 40mm
- High energy absorption capability  
 $W_{TM} = 170J$  to 1050J
- High peak pulse current capability, ITM = 25,000A to 40,000A
- Rigid terminals for secure mounting
- Available in trimmed version for through hole board mounting – Designation "HC"
- No derating up to 85°C ambient

**Absolute Maximum Ratings**

• For ratings of individual members of a series, see Device Ratings and Specifications chart

Continuous	HA Series	Units
Steady State Applied Voltage:		
AC Voltage Range ( $V_{M(AC)RMS}$ )	110 to 750	V
DC Voltage Range ( $V_{M(DC)}$ )	148 to 970	V
Transients:		
Peak Pulse Current ( $I_{TM}$ )		
For 8/20 $\mu$ s Current Wave (See Figure 2)	25,000 to 40,000	A
Single Pulse Energy Range		
For 2ms Current Squarewave ( $W_{TM}$ )	160 to 1050	J
Operating Ambient Temperature Range ( $T_A$ )	-55 to +85	°C
Storage Temperature Range ( $T_{STG}$ )	-55 to +125	°C
Temperature Coefficient (a <sup>v</sup> ) of Clamping Voltage ( $V_C$ ) at Specified Test Current	<0.01	%/°C
Hi-Pot Encapsulation (COATING Isolation Voltage Capability) (Dielectric must withstand indicated DC voltage for one minute per MIL-STD 202, Method 301)	2500	V
COATING Insulation Resistance	1000	M $\Omega$

**CAUTION:** Stresses above those listed in "Absolute Maximum Ratings" may cause permanent damage to the device. This is a stress only rating and operation of the device at these or any other conditions above those indicated in the operational sections of this specification is not implied.

HA Series

### HA Series Ratings & Specifications

Part Number Device Branding	Maximum Rating (85°C)				Specifications (25°C)				
	Continuous		Transient		Varistor Voltage at 1mA DC Test Current			Maximum Clamping Volt $V_C$ at 200A Current (8/20 $\mu$ s)	Typical Capacitance $f = 1\text{MHz}$
	$V_{RMS}$	$V_{DC}$	Energy (2ms)	Peak Current 8 x 20 $\mu$ s					
	$V_{M(AC)}$	$V_{M(DC)}$	$W_{TM}$	$I_{TM}$	(V)	(V)	(V)	$V_C$	C
(V)	(V)	Energy	(A)	(V)	(V)	(V)	(A)	(pF)	
V111HA32	110	148	160	25000	156	173	190	293	5450
V111HA40	110	148	220	40000 <sup>1</sup>	156	173	190	288	11600
V131HA32	130	175	200	25000	184	200	228	350	4700
V131HA40	130	175	270	40000 <sup>2</sup>	184	200	228	345	10000
V141HA32	140	188	210	25000	198	220	248	380	4230
V141HA40	140	188	290	40000 <sup>3</sup>	198	220	248	375	9000
V151HA32	150	200	220	25000	212	240	268	410	4000
V151HA40	150	200	300	40000 <sup>4</sup>	212	240	268	405	8000
V181HA32	180	240	240	25000	254	282	310	475	3200
V181HA40	180	240	330	40000	254	282	310	468	6800
V201HA32	200	265	260	25000	283	314	345	540	3180
V201HA40	200	265	350	40000	283	314	345	533	6350
V251HA32	250	330	330	25000	354	390	429	650	2500
V251HA40	250	330	370	40000	354	390	429	630	5000
V271HA32	275	369	360	25000	389	430	473	710	2200
V271HA40	275	369	400	40000	389	430	473	690	4500
V301HA32	300	410	370	25000	433	478	526	795	2050
V301HA40	300	410	430	40000	433	478	526	780	4100
V321HA32	320	420	390	25000	462	510	561	845	1900
V321HA40	320	420	460	40000	462	510	561	825	3800
V331HA32	330	435	385	25000	467	519	570	860	1870
V331HA40	330	435	475	40000	467	519	570	843	3750
V351HA32	350	460	390	25000	495	550	604	910	1800
V351HA40	350	460	500	40000	495	550	604	894	3600
V391HA32	385	510	395	25000	545	604	663	1020	1750
V391HA40	385	510	550	40000	545	604	663	1000	3500
V421HA32	420	560	400	25000	610	680	748	1120	1500
V421HA40	420	560	600	40000	610	680	748	1100	3000
V441HA32	440	585	420	25000	622	691	759	1200	1450
V441HA40	440	585	630	40000	622	691	759	1147	2900
V481HA32	480	640	450	25000	670	750	825	1290	1300
V481HA40	480	640	650	40000	670	750	825	1230	2700
V511HA32	510	675	500	25000	735	820	910	1355	1200
V511HA40	510	675	700	40000	735	820	910	1295	2500
V551HA32	550	710	530	25000	778	864	949	1515	1190
V551HA40	550	710	755	40000	778	864	949	1430	2390
V571HA32	575	730	550	25000	805	910	1000	1570	1100
V571HA40	575	730	770	40000	805	910	1000	1480	2200
V661HA32	660	850	600	25000	940	1050	1160	1820	1000
V661HA40	660	850	900	40000	940	1050	1160	1720	2000
V681HA32	680	875	610	25000	962	1068	1173	1830	850
V681HA40	680	875	925	40000	962	1068	1173	1780	1900
V751HA32	750	970	700	25000	1080	1200	1320	2050	800
V751HA40	750	970	1050	40000	1080	1200	1320	2000	1800

NOTE: Average power dissipation of transients not to exceed 2.0W per varistor

- 40kA capability depends on applications rated up to 97Vrms. 30kA applies if > 97 Vrms.
- 40kA capability depends on applications rated up to 115Vrms. 30kA applies if > 115 Vrms.
- 40kA capability depends on applications rated up to 123Vrms. 30kA applies if > 123 Vrms.
- 40kA capability depends on applications rated up to 132Vrms. 30kA applies if > 132Vrms.

**Power Dissipation Ratings**

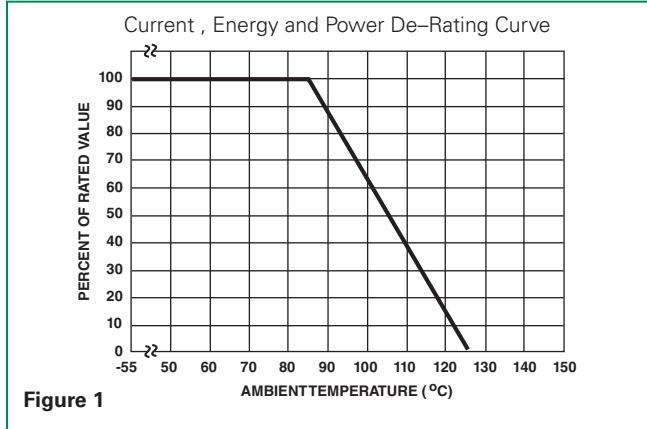


Figure 1

Should transients occur in rapid succession, the average power dissipation required is simply the energy (watt-seconds) per pulse times the number of pulses per second. The power so developed must be within the specifications shown on the Device Ratings and Specifications table for the specific device. Furthermore, the operating values need to be derated at high temperatures as shown in above. Because varistors can only dissipate a relatively small amount of average power they are, therefore, not suitable for repetitive applications that involve substantial amounts for average power dissipation.

**Peak Pulse Current Test Waveform**

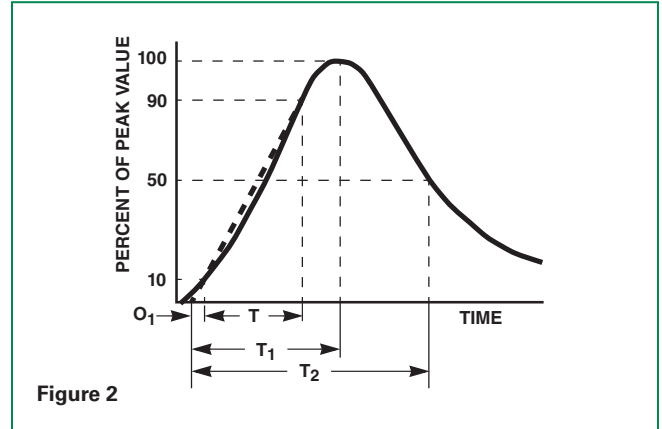


Figure 2

$O_1$  = Virtual Origin of Wave  
 $T$  = Time from 10% to 90% of Peak  
 $T_1$  = Rise Time =  $1.25 \times T$   
 $T_2$  = Decay Time

**Example** - For an  $8/20 \mu s$  Current Waveform:

$8 \mu s = T_1 = \text{Rise Time}$   
 $20 \mu s = T_2 = \text{Decay Time}$

**Maximum Clamping Voltage for 32mm Parts**

V111HA32-V751HA32

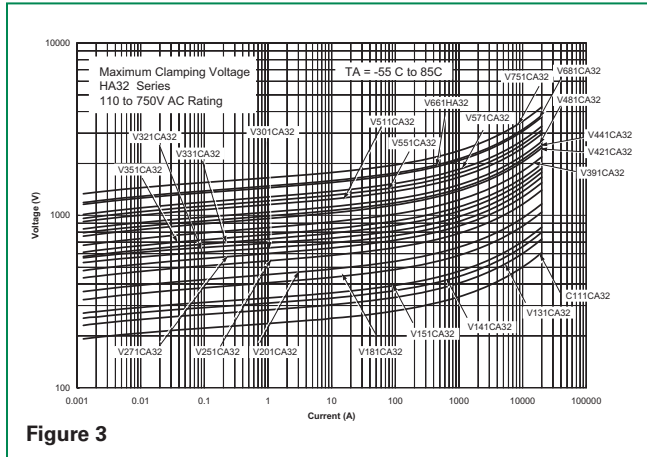


Figure 3

**Maximum Clamping Voltage for 40mm Parts**

V111HA40-V751HA40

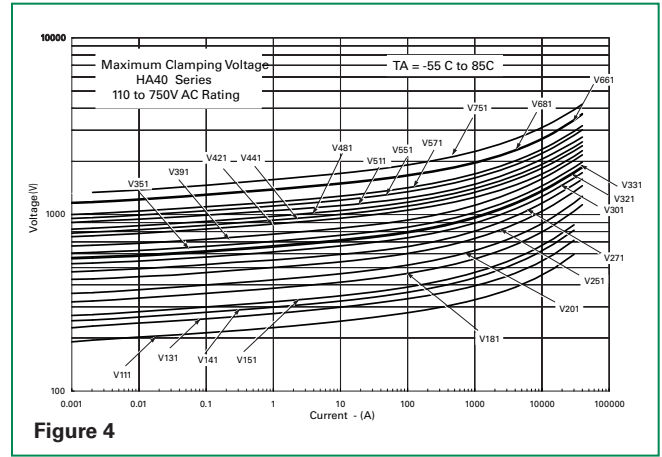


Figure 4

HA Series

### Repetitive Surge Capability for 32mm Parts

V111HA32 – V751HA32

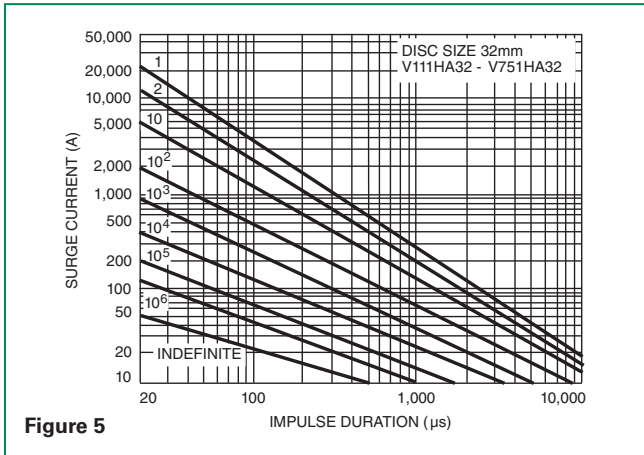


Figure 5

### Repetitive Surge Capability for 40mm Parts

V111HA40 – V751HA40

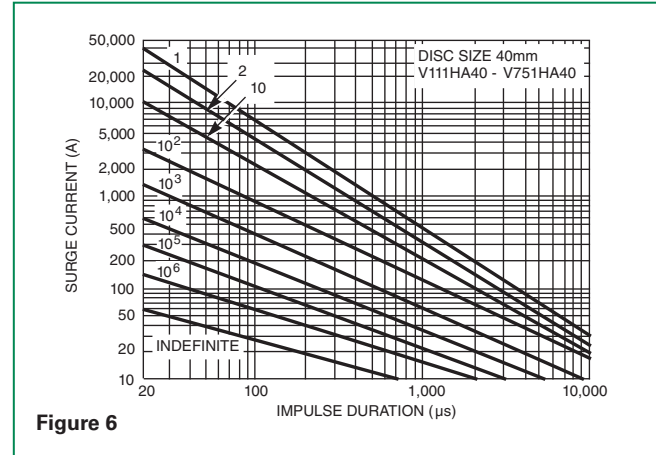


Figure 6

### Wave Solder Profile

### Non Lead-free Profile

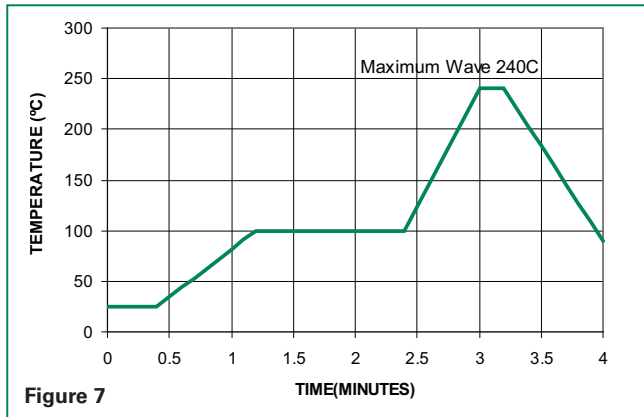


Figure 7

### Lead-free Profile

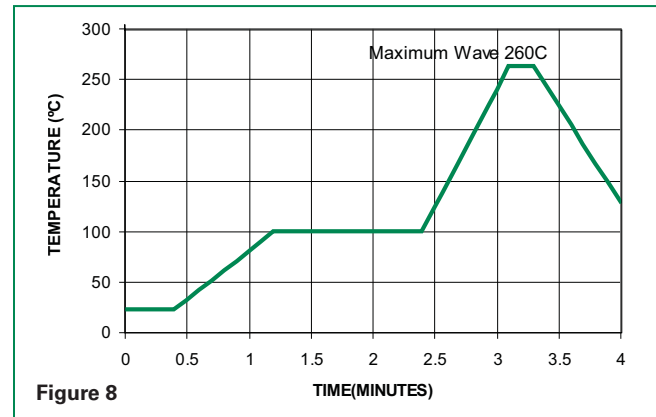


Figure 8

### Physical Specifications

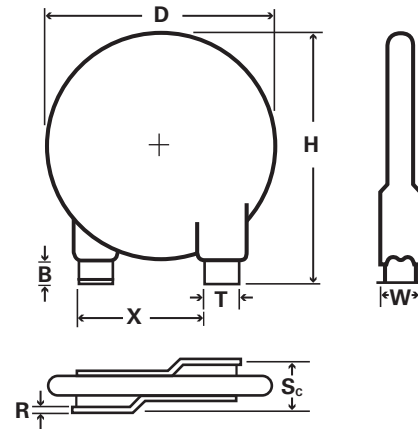
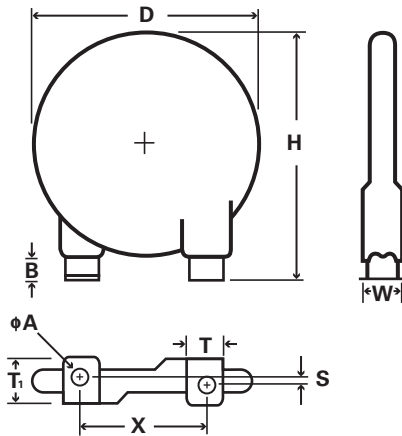
<b>Lead Material</b>	Tin-plated Copper
<b>Soldering Characteristics</b>	Solderability per MIL-STD-202, Method 208E
<b>Insulating Material</b>	Cured, flame retardant epoxy polymer meets UL94V-0 requirements.
<b>Device Labeling</b>	LF, Part Number and date code

### Environmental Specifications

<b>Operating/Storage Temperature</b>	-55°C to +85°C/ -55°C to +125°C
<b>Humidity Aging</b>	+85°C, 85% RH, 1000 hours +/- 10% typical resistance change
<b>Thermal Shock</b>	+85°C to -40°C 10 times +/- 10% typical resistance change
<b>Solvent Resistance</b>	MIL-STD-202, Method 215F
<b>Moisture Sensitivity</b>	Level 1, J-STD-020C



**Dimensions**



**HA Series Outline Specifications**

(Dimensions in Millimeters)

	D	H	B	X	T	T1	φA	s
	Max	Max	Min	Nom	Nom	Max	Max	Offset
HA32	35.5	50.00	3.0	25	9.3	10.4	4.2	Depends on Device Voltage (See Table Below)
HA40	42.5	57.00	3.0	25	9.3	10.4	4.2	

**HC Series Outline Specifications**

(Dimensions in Millimeters)

	D	H	B	X	T	R	s <sub>c</sub>
	Max	Max	Min	Nom	Nom	Max	Offset
HC32	35.5	50.00	5.0	25	9.30	1.0	Depends on Device Voltage (See Table Below)
HC40	42.5	57.00	5.0	25	9.30	1.0	

**HA Series Maximum Thickness and Terminal Offsets**

(Dimensions in Millimeters)

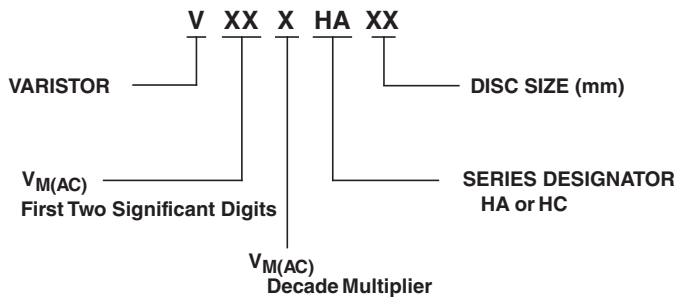
Voltage	Thickness "W"		Dimension "S" (-/+1mm)	
	HA32	HA40	HA32	HA40
V111 - V351	9.00	9.00	3.90	3.90
V391 - V511	11.00	11.00	2.60	2.60
V551 - V751	13.00	13.00	1.00	1.00

**HC Series Maximum Thickness and Terminal Offsets**

(Dimensions in Millimeters)

Voltage	Thickness "W"		Dimension "S <sub>c</sub> " (-/+1mm)	
	HC32	HC40	HC32	HC40
V111 - V351	9.00	9.00	6.00	6.00
V391 - V511	11.00	11.00	7.30	8.10
V551 - V751	13.00	13.00	8.90	10.00

**Part Numbering System**






**RoHS (Pb) TMOV34S® Varistor Series**

**Description**

The Littelfuse Industrial TMOV34S® Series thermally protected varistor represents a new development in circuit protection. It consists of a 34mm square format varistor element (MOV) with an integral thermally activated element designed to open in the event of overheating due to abnormal overvoltage, limited current conditions as outlined in UL1449 Feb. 1998 edition. The device has a third lead, an indicator lead, which may be used to indicate that the MOV has been disconnected from the circuit. This lead facilitates connection to monitoring circuitry. The TMOV34S® devices offer quick thermal response due to the close proximity of the integrated thermal element to the MOV body. The integrated configuration also offers lower inductance than most discrete solutions resulting in improved clamping performance to fast over voltage transients.

**Agency Approvals**

Agency	Agency File Number
	E75961

**Applications**

- TVSS Products
- AC Panel Protection Modules
- AC Line Power Supplies
- AC Power Meters
- UPS (Uninterruptable Power Supply)
- Inverters
- AC/DC Power Supplies
- DIN Rail

**Features**

- US patent for thermally protected MOV—Patent # 6636403
- Designed to facilitate compliance to UL1449 for TVSS product
- High peak current rating to 40 kA
- -55°C to +85°C operating temp
- Agency recognition: UL
- Alternative design available with narrow 3mm wide monitor (right) lead
- Alternative design available with 2 leads only (no monitor lead)
- RoHS Compliant and Lead-free Available

**Absolute Maximum Ratings**

\* For ratings of individual members of a series, see Device Ratings and Specifications chart

Continuous	HA Series	Units
Steady State Applied Voltage:		
AC Voltage Range ( $V_{MIACIRMS}$ )	115 to 750	V
Transients:		
Peak Pulse Current ( $I_{TM}$ )		
For 8/20 $\mu$ s Current Wave, single pulse	up to 40,000	A
Single Pulse Energy Range		
For 2ms Current Wave	235 to 1050	J
Operating Ambient Temperature Range ( $T_a$ )	-55 to + 85	°C
Storage Temperature Range ( $T_{STG}$ )	-55 to + 125	°C
Temperature Coefficient ( $\alpha^V$ ) of Clamping Voltage ( $V_c$ ) at Specified Test Current	<0.01	%/°C
Hi-Pot Encapsulation (Isolation Voltage Capability)	2500	V
Thermal Protection Isolation Voltage Capability (when operated) -Under UL1449 Limited Current Test Procedure—see Note #1	600	V
Hi-Pot Encapsulation (COATING Isolation Voltage Capability)		V
COATING Insulation Resistance	1000	M $\Omega$

#1 – Under UL 1449 limited current testing parts rated >420V will not open due to 600V voltage limit. Devices with ratings >420V have not yet been evaluated.

**CAUTION:** Stresses above those listed in "Absolute Maximum Ratings" may cause permanent damage to the device. This is a stress only rating and operation of the device at these or any other conditions above those indicated in the operational sections of this specification is not implied.

### TMOV34S® Series Ratings & Specifications - Standard 3 Lead Design

Lead-free and RoHS Compliant Models	Standard Models	Maximum Rating (85°C)					Specifications (25°C)			
		Continuous		Transient			Varistor Voltage at 1mA Test Current	Maximum Clamping Volt $V_C$ at 200A Current (8/20 $\mu$ s)	Typical Capacitance $f = 1$ MHz	
		AC Volts	DC Volts	MCOV Surge Arrester	Energy 2ms	Peak Current 8 x 20 $\mu$ s				
Part Number	Part Number	$V_{MIACIRMS}$ (V)	$V_{MIAC}$	$V_{MIACIRMS}$ (V)	$W_{TM}$ 1 x Pulse (J)	$I_{TM}$ 1 x Pulse (A)	$V_{NIDC}$ Min (V)	$V_{NIDC}$ Max (V)	$V_C$ (V)	C (pF)
TMOV34S111MP	TMOV34S111M	115	150	98	235	40000 <sup>1</sup>	163	202	305	11500
TMOV34S131MP	TMOV34S131M	130	175	111	270	40000 <sup>2</sup>	184	228	345	10000
TMOV34S141MP	TMOV34S141M	140	188	119	291	40000 <sup>3</sup>	198	248	375	9000
TMOV34S151MP	TMOV34S151M	150	200	128	300	40000 <sup>4</sup>	212	268	405	8000
TMOV34S181MP	TMOV34S181M	180	240	153	330	40000 <sup>5</sup>	254	312	488	6800
TMOV34S201MP	TMOV34S201M	200	265	170	335	40000	283	357	540	6500
TMOV34S251MP	TMOV34S251M	250	330	213	370	40000	354	429	650	5000
TMOV34S271MP	TMOV34S271M	275	369	234	400	40000	389	473	730	4500
TMOV34S301MP	TMOV34S301M	300	400	255	435	40000	433	528	780	4050
TMOV34S321MP	TMOV34S321M	320	420	272	460	40000	462	561	830	3800
TMOV34S331MP	TMOV34S331M	330	435	281	475	40000	476	581	855	3700
TMOV34S351MP	TMOV34S351M	350	460	298	500	40000	505	616	910	3500
TMOV34S391MP	TMOV34S391M	385	506	327	550	40000	555	678	1005	3300
TMOV34S421MP	TMOV34S421M	420	560	357	600	40000	610	748	1130	3000
TMOV34S461MP	TMOV34S461M	460	610	391	620	40000	642	783	1188	2800
TMOV34S481MP	TMOV34S481M	480	640	408	650	40000	670	825	1240	2700
TMOV34S511MP	TMOV34S511M	510	675	434	700	40000	735	910	1350	2500
TMOV34S551MP	TMOV34S551M	550	700	468	735	40000	770	939	1415	2250
TMOV34S571MP	TMOV34S571M	575	730	489	770	40000	805	1000	1480	2200
TMOV34S621MP	TMOV34S621M	620	800	527	840	40000	880	1074	1589	2100
TMOV34S661MP	TMOV34S661M	660	850	561	900	40000	940	1160	1720	2000
TMOV34S681MP	TMOV34S681M	680	890	578	950	40000	980	1195	1772	1970
TMOV34S751MP	TMOV34S751M	750	970	638	1050	40000	1080	1320	2000	1800

**Notes :**

Same ratings and specifications apply to 2 leaded alternative design. Replace 'M' with 'E' in part number. Refer to Part Numbering System at the end of this document..

1. Peak current applies to applications rated up to 100 VAC<sub>RMS</sub><sup>1</sup>, 132 V<sub>DC</sub><sup>1</sup>. Peak current is 30kA max for applications greater than 100 VAC<sub>RMS</sub><sup>1</sup>, 132 V<sub>DC</sub><sup>1</sup>.
2. Peak current applies to applications rated up to 115 VAC<sub>RMS</sub><sup>2</sup>, 145 V<sub>DC</sub><sup>2</sup>. Peak current is 30kA max for applications greater than 115 VAC<sub>RMS</sub><sup>2</sup>, 145 V<sub>DC</sub><sup>2</sup>.
3. Peak current applies to applications rated up to 123 VAC<sub>RMS</sub><sup>3</sup>, 165 V<sub>DC</sub><sup>3</sup>. Peak current is 30kA max for applications greater than 123 VAC<sub>RMS</sub><sup>3</sup>, 165 V<sub>DC</sub><sup>3</sup>.
4. Peak current applies to applications rated up to 132 VAC<sub>RMS</sub><sup>4</sup>, 176 V<sub>DC</sub><sup>4</sup>. Peak current is 30kA max for applications greater than 132 VAC<sub>RMS</sub><sup>4</sup>, 176 V<sub>DC</sub><sup>4</sup>.
5. Peak current applies to applications rated up to 158 VAC<sub>RMS</sub><sup>5</sup>, 211 V<sub>DC</sub><sup>5</sup>. Peak current is 30kA max for applications greater than 158 VAC<sub>RMS</sub><sup>5</sup>, 211 V<sub>DC</sub><sup>5</sup>.

### TMOV34S® Series Ratings & Specifications - Alternative 2 Lead Design

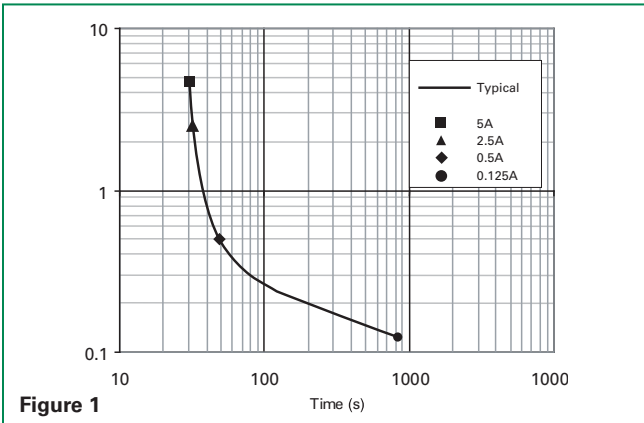
Lead-free and RoHS Compliant Models	Maximum Rating (85°C)					Specifications (25°C)			
	Continuous		Transient			Varistor Voltage at 1mA Test Current	Maximum Clamping Volt $V_C$ at 200A Current (8/20 $\mu$ s)	Typical Capacitance $f = 1$ MHz	
	AC Volts	DC Volts	MCOV Surge Arrester	Energy 2ms	Peak Current 8 x 20 $\mu$ s				
Part Number	$V_{M(A)C/RMS}$	$V_{M(A)C}$	$V_{M(A)C/RMS}$	$W_{TM}$ 1 x Pulse	$I_{TM}$ 1 x Pulse	$V_{N(D)C}$ Min	$V_{N(D)C}$ Max	$V_C$	C
	(V)		(V)	(J)	(A)	(V)	(V)	(V)	(pF)
TMOV34S111EP	115	150	98	235	40000 <sup>1</sup>	163	202	305	11500
TMOV34S131EP	130	175	111	270	40000 <sup>2</sup>	184	228	345	10000
TMOV34S141EP	140	188	119	291	40000 <sup>3</sup>	198	248	375	9000
TMOV34S151EP	150	200	128	300	40000 <sup>4</sup>	212	268	405	8000
TMOV34S181EP	180	240	153	330	40000 <sup>5</sup>	254	312	488	6800
TMOV34S201EP	200	265	170	335	40000	283	357	540	6500
TMOV34S251EP	250	330	213	370	40000	354	429	650	5000
TMOV34S271EP	275	369	234	400	40000	389	473	730	4500
TMOV34S301EP	300	400	255	435	40000	433	528	780	4050
TMOV34S321EP	320	420	272	460	40000	462	561	830	3800
TMOV34S331EP	330	435	281	475	40000	476	581	855	3700
TMOV34S351EP	350	460	298	500	40000	505	616	910	3500
TMOV34S391EP	385	506	327	550	40000	555	678	1005	3300
TMOV34S421EP	420	560	357	600	40000	610	748	1130	3000
TMOV34S461EP	460	610	391	620	40000	642	783	1188	2800
TMOV34S481EP	480	640	408	650	40000	670	825	1240	2700
TMOV34S511EP	510	675	434	700	40000	735	910	1350	2500
TMOV34S551EP	550	700	468	735	40000	770	939	1415	2250
TMOV34S571EP	575	730	489	770	40000	805	1000	1480	2200
TMOV34S621EP	620	800	527	840	40000	880	1074	1589	2100
TMOV34S661EP	660	850	561	900	40000	940	1160	1720	2000
TMOV34S681EP	680	890	578	950	40000	980	1195	1772	1970
TMOV34S751EP	750	970	638	1050	40000	1080	1320	2000	1800

Notes :

Same ratings and specifications apply to 3 leaded design. Replace 'E' with 'M' in part number. Refer to Part Numbering System at the end of this document..

1. Peak current applies to applications rated up to 100 VAC<sub>RMS</sub>, 132 V<sub>DC</sub>. Peak current is 30kA max for applications greater than 100 VAC<sub>RMS</sub>, 132 V<sub>DC</sub>.
2. Peak current applies to applications rated up to 115 VAC<sub>RMS</sub>, 145 V<sub>DC</sub>. Peak current is 30kA max for applications greater than 115 VAC<sub>RMS</sub>, 145 V<sub>DC</sub>.
3. Peak current applies to applications rated up to 123 VAC<sub>RMS</sub>, 165 V<sub>DC</sub>. Peak current is 30kA max for applications greater than 123 VAC<sub>RMS</sub>, 165 V<sub>DC</sub>.
4. Peak current applies to applications rated up to 132 VAC<sub>RMS</sub>, 176 V<sub>DC</sub>. Peak current is 30kA max for applications greater than 132 VAC<sub>RMS</sub>, 176 V<sub>DC</sub>.
5. Peak current applies to applications rated up to 158 VAC<sub>RMS</sub>, 211 V<sub>DC</sub>. Peak current is 30kA max for applications greater than 158 VAC<sub>RMS</sub>, 211 V<sub>DC</sub>.

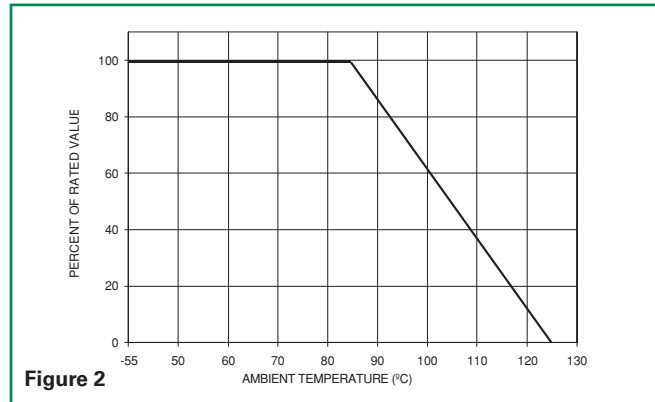
### Typical time to open circuit under UL1449 Abnormal Overvoltage Limited Current Test



**Figure 1**

Note: The Industrial TMOV® Series TMOV34S® devices are intended, in conjunction with appropriate enclosure design, to help facilitate TVSS module compliance to UL 1449, Section 37.4 (Abnormal Overvoltage Limited Current Requirements). Under these extreme abnormal overvoltage conditions, the units will exhibit substantial heating and potential venting prior to opening. Modules should be designed to contain this possibility. Application testing is strongly recommended.

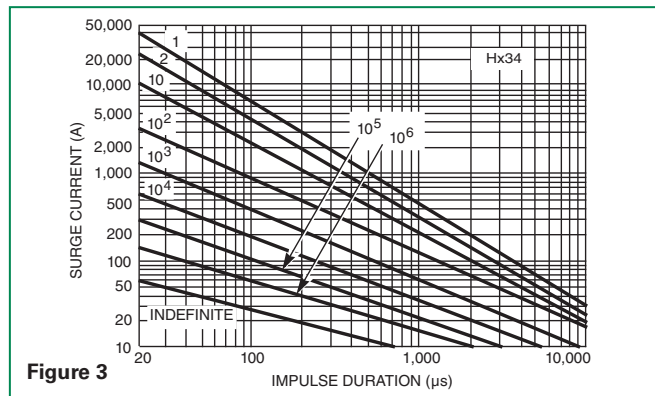
### Peak Current & Energy Derating Curve



**Figure 2**

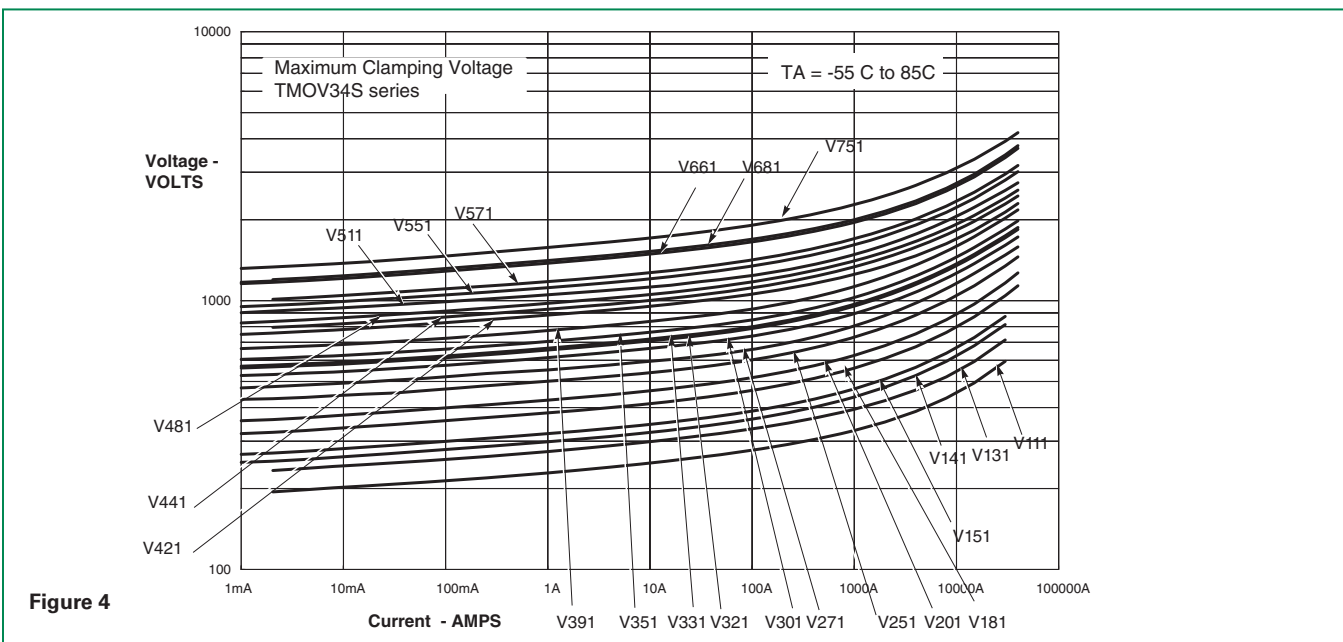
For applications exceeding 85°C ambient temperature, the peak surge current and energy ratings must be reduced as shown.

### Pulse Rating Curve



**Figure 3**

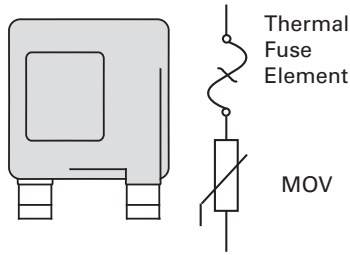
### V-I Characteristic Curves for TMOV34S® Varistor



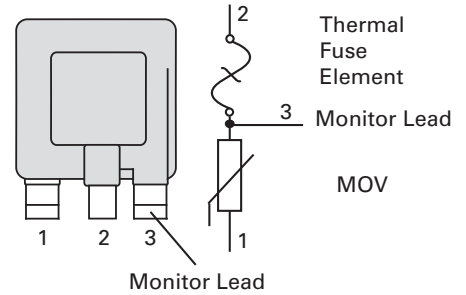
**Figure 4**

**Lead Configurations**

**TMOV34S® "E" 2-Lead Varistor**



**TMOV34S® "M" 3-Lead Varistor**



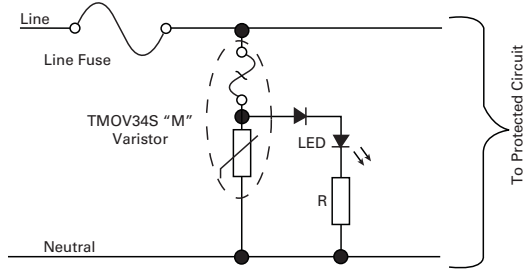
Note: MOVs are non-polarized passive elements

**TMOV34S® Varistor Application Examples**

The application examples below show how the monitor lead on the TMOV34S® can be used to indicate that the thermal element has been opened. This signifies that the circuit is no longer protected from transients by the MOV.

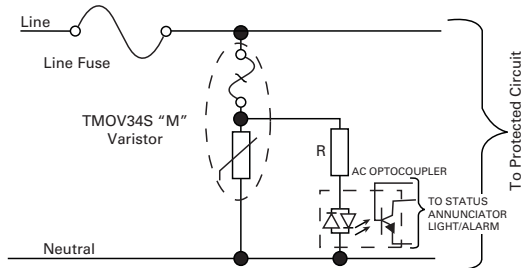
**Application Example 1**

In this case, the LED is normally on, and is off when the thermal element opens.



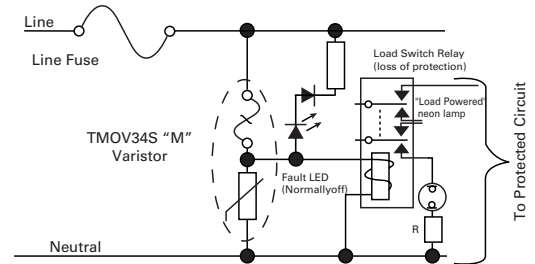
**Application Example 2**

This circuit utilizes an optocoupler to provide galvanic isolations between the TMOV34S® varistor and the indicating or alarm circuitry.



**Application Example 3**

This circuit illustrates the use of the monitoring lead of the TMOV34S® varistor to ensure that equipment is only operated when overvoltage protection present. In normal operation the load switch relay solenoid is powered via the monitor lead of the TMOV34S® varistor. In the event of the thermal element being activated, the relay will de-activate, cutting power to the protected circuit and the fault LED will illuminate.



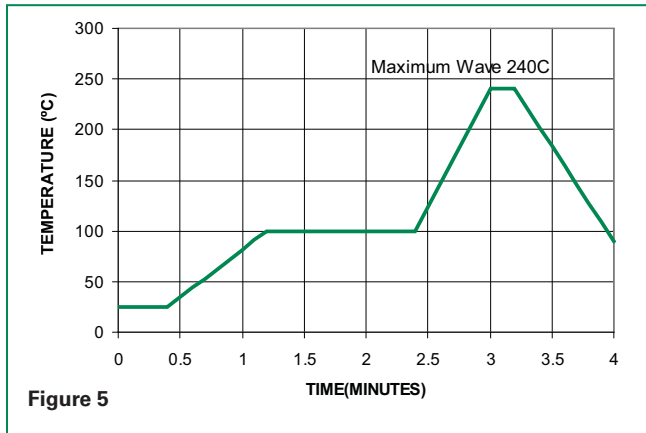
Please note: Indicator circuits are provided as a guideline only. Verification of actual indicator circuitry is the responsibility of the end user. Component values selected must be appropriate for the specific AC line voltage service and application.

### Wave Solder Profile

Because the TMOV34S® Series varistors contain a thermal protection device, care must be taken when soldering the devices into place. Two soldering methods are possible. Firstly, hand soldering:

It is recommended to heat-sink the leads of the device. Secondly, wave-soldering: It is critically important that all preheat stage and the solder bath temperatures are rigidly controlled.

### Non Lead-free Profile



### Lead-free Profile



### Physical Specifications

<b>Lead Material</b>	Tin-plated Copper
<b>Soldering Characteristics</b>	Solderability per MIL-STD-202, Method 208E
<b>Insulating Material</b>	Cured, flame retardant epoxy polymer meets UL94V-0 requirements.
<b>Device Labeling</b>	Marked with LF, part identifier, and date code

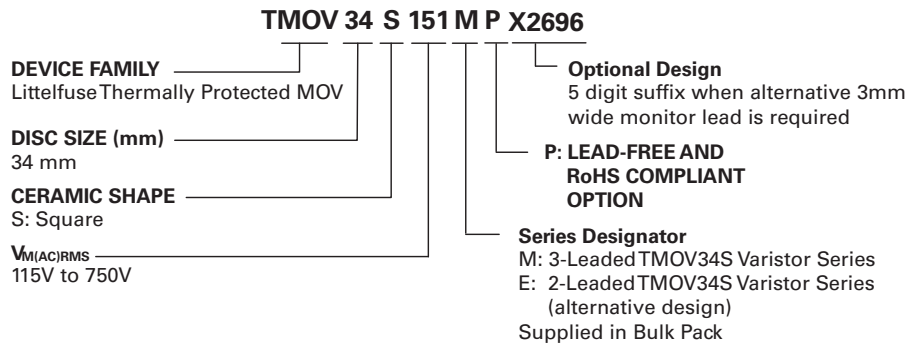
### Environmental Specifications

<b>Operating/Storage Temperature</b>	-55°C to +85°C/ -55°C to +125°C
<b>Humidity Aging</b>	+85°C, 85% RH, 1000 hours +/-10% voltage
<b>Thermal Shock</b>	+85°C to -40°C 10 times +/-10% voltage
<b>Solvent Resistance</b>	MIL-STD-202, Method 215F
<b>Moisture Sensitivity</b>	Level 1, J-STD-020C







Part Numbering System



**RoHS (Pb) HB34, HF34 and HG34 Varistor Series**

**Agency Approvals**

Agency	Agency File Number
	E320116
	LR91788

**Description**

The HB34, HF34, and HG34 Series of transient surge suppressors are industrial high-energy Metal-Oxide Varistors (MOVs). They are designed to provide surge suppression in the AC mains outdoor and service entrance environment (distribution panels) of buildings. Applications also include industrial heavy motors, controls, and power supplies such as used in the oil-drilling, mining, and transportation fields, including HVAC and motor/generator applications.

The HB34 Series provides rigid terminals for through-hole solder mounting on printed circuit boards, thereby eliminating the need for screw mounting. The HF34 Series has the same rigid through-hole terminals as the HB34 with the addition of mounting holes for bolt-down mounting and longer terminals to allow for additional mounting flexibility. The HG34 has formed feet with mounting holes for vertical bolt-down mounting.

See Ratings and Specifications table for part numbers.

**Features**

- RoHS Compliant and Lead-free available
- Wide operating voltage range  
 $V_{M(AC)RMS}$  110V to 750V
- High energy absorption capability  
 $W_{TM}$  = 220J to 1050J
- High peak pulse current capability  
 $I_{TM}$  = 40,000A
- Rigid terminals for secure through-hole solder mounting
- No derating up to 85°C ambient

**Absolute Maximum Ratings**

• For ratings of individual members of a series, see Device Ratings and Specifications chart

Continuous	Hx34 Series	Units
Steady State Applied Voltage:		
AC Voltage Range ( $V_{M(AC)RMS}$ )	110 to 750	V
DC Voltage Range ( $V_{M(DC)}$ )	148 to 970	V
Transients:		
Peak Pulse Current ( $I_{TM}$ ) For 8/20 $\mu$ s Current Wave (See Figure 2)	40000	A
Single Pulse Energy Range For 2ms Current Wave ( $W_{TM}$ )	220 to 1050	J
Operating Ambient Temperature Range ( $T_A$ )	-55 to +85	°C
Storage Temperature Range ( $T_{STG}$ )	-55 to +125	°C
Temperature Coefficient ( $\alpha^V$ ) of Clamping Voltage ( $V_C$ ) at Specified Test Current	<0.01	%/°C
Hi-Pot Encapsulation (COATING Isolation Voltage Capability) (Dielectric must withstand indicated DC voltage for one minute per MIL-STD 202, Method 301)		V
COATING Insulation Resistance		M $\Omega$

**CAUTION:** Stresses above those listed in "Absolute Maximum Ratings" may cause permanent damage to the device. This is a stress only rating and operation of the device at these or any other conditions above those indicated in the operational sections of this specification is not implied.

### HB34 Series Ratings & Specifications

Lead-free and RoHS Compliant Models	Model Size Disc Dia. (mm)	Maximum Rating (85°C)				Specifications (25°C)				
		Continuous		Transient		Varistor Voltage at 1mA DC Test Current			Maximum Clamping Voltage $V_C$ at 200A Current (8/20 $\mu$ s)	Typical Capacitance
		$V_{RMS}$	$V_{DC}$	Energy (2ms)	Peak Current $8 \times 20\mu s$					
Part Number		$V_{M(AC)}$ (V)	$V_{M(DC)}$ (V)	$W_{TM}$ (J)	$I_{TM}$ (A)	Min (V)	$V_{N(DC)}$ (V)	Max (V)	$V_C$ (V)	$f = 1\text{MHz}$ (pF)
V111HB34	34	110	148	220	40,000 <sup>1</sup>	156	173	190	288	11,600
V131HB34	34	130	175	270	40,000 <sup>2</sup>	184	200	228	345	10,000
V141HB34	34	140	188	291	40,000 <sup>3</sup>	198	220	248	375	9,000
V151HB34	34	150	200	300	40,000 <sup>4</sup>	212	240	268	405	8,000
V181HB34	34	180	240	330	40,000	254	282	310	468	6,800
V201HB34	34	200	265	350	40,000	283	314	345	533	6,350
V251HB34	34	250	330	370	40,000	354	390	429	650	5,000
V271HB34	34	275	370	400	40,000	389	430	473	730	4,500
V301HB34	34	300	410	430	40,000	433	478	526	780	4,100
V321HB34	34	320	420	460	40,000	462	510	561	830	3,800
V331HB34	34	330	435	475	40,000	467	519	570	843	3,750
V351HB34	34	350	460	500	40,000	495	550	604	894	3,600
V391HB34	34	385	510	550	40,000	545	604	663	1000	3,500
V421HB34	34	420	560	600	40,000	610	680	748	1,130	3,000
V441HB34	34	440	587	620	40,000	622	691	759	1,150	2,900
V481HB34	34	480	640	650	40,000	670	750	825	1,240	2,700
V511HB34	34	510	675	700	40,000	735	820	910	1,350	2,500
V551HB34	34	550	710	755	40,000	778	864	949	1,404	2,390
V571HB34	34	570	730	770	40,000	805	910	1000	1,480	2,200
V661HB34	34	660	850	900	40,000	940	1050	1160	1,720	2,000
V681HB34	34	680	875	925	40,000	962	1068	1173	1,777	1,900
V751HB34	34	750	970	1050	40,000	1080	1200	1320	2,000	1,800

NOTE: Average power dissipation of transients not to exceed 2.0W.

1. Peak current applies to applications rated up to 97 $V_{RMS}$ . Peak current is 30kA for applications greater than 97V.
2. Peak current applies to applications rated up to 115 $V_{RMS}$ . Peak current is 30kA for applications greater than 115V.
3. Peak current applies to applications rated up to 123 $V_{RMS}$ . Peak current is 30kA for applications greater than 123V.
4. Peak current applies to applications rated up to 132 $V_{RMS}$ . Peak current is 30kA for applications greater than 132V.

### HF34 Series Ratings & Specifications

Lead-free and RoHS Compliant Models	Model Size Disc Dia. (mm)	Maximum Rating (85°C)				Specifications (25°C)				
		Continuous		Transient		Varistor Voltage at 1mA DC Test Current			Maximum Clamping Voltage $V_C$ at 200A Current (8/20 $\mu$ s)	Typical Capacitance
		$V_{RMS}$	$V_{DC}$	Energy (2ms)	Peak Current 8 x 20 $\mu$ s					
		Part Number	$V_{M(AC)}$ (V)	$V_{M(DC)}$ (V)	$W_{TM}$ (J)	$I_{TM}$ (A)	Min (V)	$V_{N(DC)}$ (V)	Max (V)	$V_C$ (V)
V111HF34	34	110	148	220	40,000 <sup>1</sup>	156	173	190	288	11,600
V131HF34	34	130	175	270	40,000 <sup>2</sup>	184	200	228	345	10,000
V141HF34	34	140	188	291	40,000 <sup>3</sup>	198	220	248	375	9,000
V151HF34	34	150	200	300	40,000 <sup>4</sup>	212	240	268	405	8,000
V181HF34	34	180	240	330	40,000	254	282	310	468	6,800
V201HF34	34	200	265	350	40,000	283	314	345	533	6,350
V251HF34	34	250	330	370	40,000	354	390	429	650	5,000
V271HF34	34	275	370	400	40,000	389	430	473	730	4,500
V301HF34	34	300	410	430	40,000	433	478	526	780	4,100
V321HF34	34	320	420	460	40,000	462	510	561	830	3,800
V331HF34	34	330	435	475	40,000	467	519	570	843	3,750
V351HF34	34	350	460	500	40,000	495	550	604	894	3,600
V391HF34	34	385	510	550	40,000	545	604	663	1,000	3,500
V421HF34	34	420	560	600	40,000	610	680	748	1,130	3,000
V441HF34	34	440	587	620	40,000	622	691	759	1,150	2,900
V481HF34	34	480	640	650	40,000	670	750	825	1,240	2,700
V511HF34	34	510	675	700	40,000	735	820	910	1,350	2,500
V551HF34	34	550	710	755	40,000	778	864	949	1,404	2,390
V571HF34	34	570	730	770	40,000	805	910	1000	1,480	2,200
V661HF34	34	660	850	900	40,000	940	1050	1160	1,720	2,000
V681HF34	34	680	875	925	40,000	962	1068	1173	1777	1,900
V751HF34	34	750	970	1050	40,000	1080	1200	1320	2,000	1,800

Note:

1. Peak current applies to applications rated up to 97 $V_{RMS}$ . Peak current is 30kA for applications greater than 97V.
2. Peak current applies to applications rated up to  $V_{RMS}$ . Peak current is 30kA for applications greater than 115V.
3. Peak current applies to applications rated up to  $V_{RMS}$ . Peak current is 30kA for applications greater than 123V.
4. Peak current applies to applications rated up to  $V_{RMS}$ . Peak current is 30kA for applications greater than 132V.

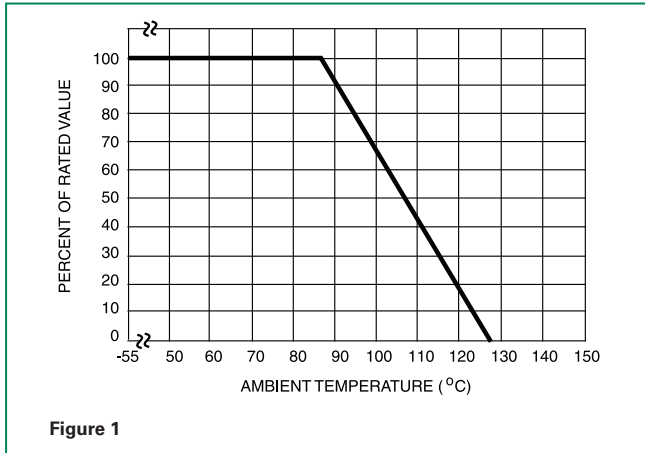
### HG34 Series Ratings & Specifications

Lead-free and RoHS Compliant Models	Model Size Disc Dia. (mm)	Maximum Rating (85°C)				Specifications (25°C)				
		Continuous		Transient		Varistor Voltage at 1mA DC Test Current			Maximum Clamping Voltage $V_C$ at 200A Current (8/20 $\mu$ s)	Typical Capacitance
		$V_{RMS}$	$V_{DC}$	Energy (2ms)	Peak Current 8 x 20 $\mu$ s					
Part Number		$V_{M(AC)}$ (V)	$V_{M(DC)}$ (V)	$W_{TM}$ (J)	$I_{TM}$ (A)	Min (V)	$V_{N(DC)}$ (V)	Max (V)	$V_C$ (V)	$f = 1$ MHz (pF)
V111HG34	34	110	148	220	40,000 <sup>1</sup>	156	173	190	288	11,600
V131HG34	34	140	175	270	40,000 <sup>2</sup>	184	200	228	345	10,000
V141HG34	34	130	188	291	40,000 <sup>3</sup>	198	220	248	375	9,000
V151HG34	34	150	200	300	40,000 <sup>4</sup>	212	240	268	405	8,000
V181HG34	34	180	240	330	40,000	254	282	310	468	6,800
V201HG34	34	200	265	350	40,000	283	314	345	533	6,350
V251HG34	34	250	330	370	40,000	354	390	429	650	5,000
V271HG34	34	275	370	400	40,000	389	430	473	730	4,500
V301HG34	34	300	410	430	40,000	433	478	526	780	4,100
V321HG34	34	320	420	460	40,000	462	510	561	830	3,800
V331HG34	34	330	435	475	40,000	467	519	570	843	3,750
V351HG34	34	350	460	500	40,000	495	550	604	894	3,600
V331HG34	34	385	510	550	40,000	545	604	663	1,000	3,500
V421HG34	34	420	560	600	40,000	610	680	748	1,130	3,000
V441HG34	34	440	587	620	40,000	622	691	759	1,150	2,900
V481HG34	34	480	640	650	40,000	670	750	825	1,240	2,700
V511HG34	34	510	675	700	40,000	735	820	910	1,350	2,500
V551HG34	34	550	710	755	40,000	778	864	949	1,404	2,390
V571HG34	34	570	730	770	40,000	805	910	1000	1,480	2,200
V661HG34	34	660	850	900	40,000	940	1050	1160	1,720	2,000
V681HG34	34	680	875	925	40,000	962	1068	1173	1,777	1,900
V751HG34	34	750	970	1050	40,000	1080	1200	1320	2,000	1,800

Note :

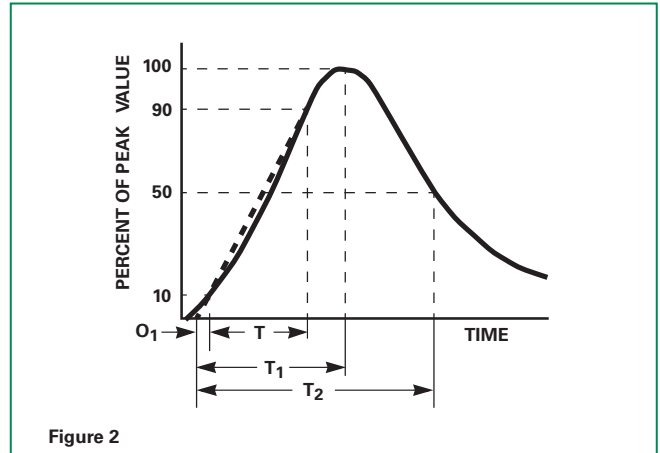
1. Peak current applies to applications rated up to 97 $V_{RMS}$ . Peak current is 30kA for applications greater than 97V.
2. Peak current applies to applications rated up to 115 $V_{RMS}$ . Peak current is 30kA for applications greater than 115V.
3. Peak current applies to applications rated up to 123 $V_{RMS}$ . Peak current is 30kA for applications greater than 123V.
4. Peak current applies to applications rated up to 132 $V_{RMS}$ . Peak current is 30kA for applications greater than 132V.

**Power Dissipation Ratings**



Should transients occur in rapid succession, the average power dissipation result is simply the energy (watt-seconds) per pulse times the number of pulses per second. The power so developed must be within the specifications shown on the Device Ratings and Specifications Table for the specific device. The operating values must be derated as shown in above.

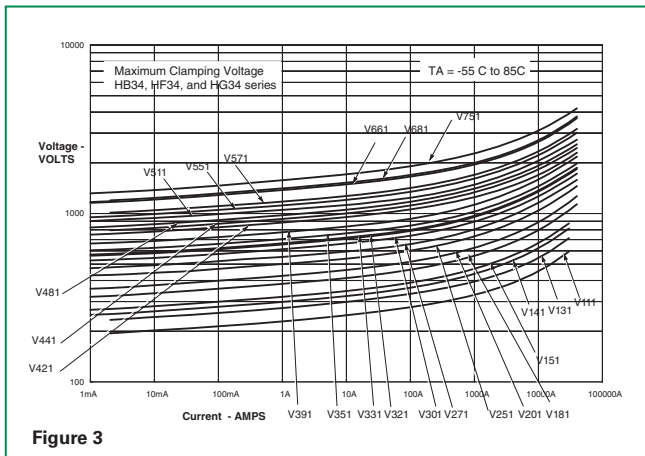
**Peak Pulse Current Test Waveform**



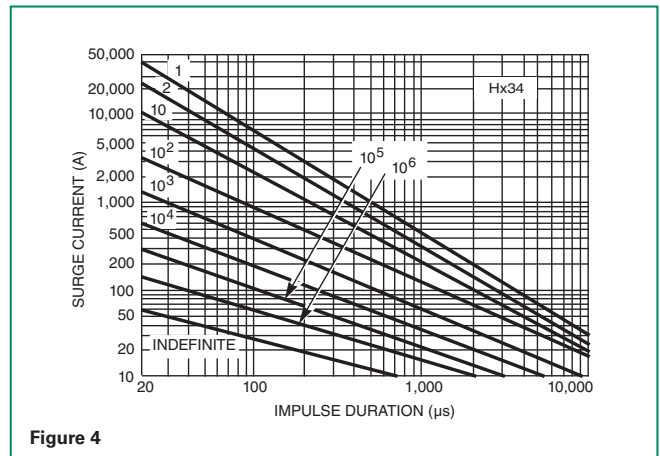
$O_1$  = Virtual Origin of Wave  
 $T$  = Time from 10% to 90% of Peak  
 $T_1$  = Rise Time =  $1.25 \times T$   
 $T_2$  = Decay Time

**Example** - For an  $8/20 \mu s$  Current Waveform:  
 $8 \mu s = T_1$  = Rise Time  
 $20 \mu s = T_2$  = Decay Time

**Clamping Voltage for HB34, HF34 and HG34 Series**



**Surge Current Rating Curves for HB34, HF34 and HG34 Series**



NOTE: If pulse ratings are exceeded, a shift of  $V_{NIDC}$  (at specified current) of more than +/-10% could result. This type of shift, which normally results in a decrease of  $V_{NIDC}$ , may result in the device not meeting the original published specifications, but it does not prevent the device from continuing to function, and to provide ample protection.

**HBx/HFx/HGx Series**

### Wave Solder Profile

#### Non Lead-free Profile

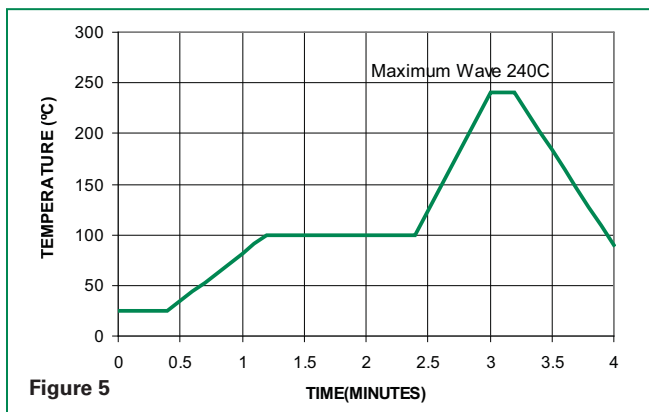


Figure 5

#### Lead-free Profile

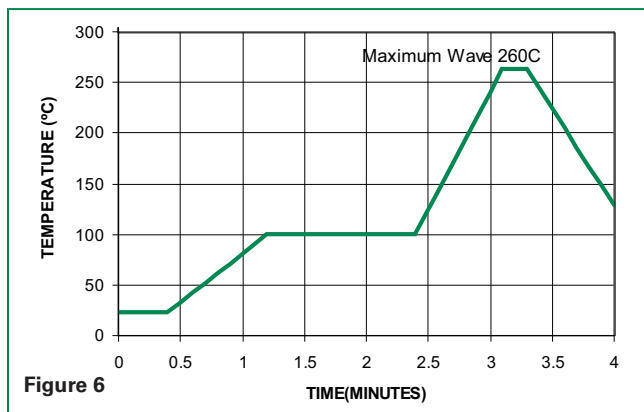


Figure 6

### Physical Specifications

<b>Lead Material</b>	Tin-plated Copper
<b>Soldering Characteristics</b>	Solderability per MIL-STD-202, Method 208E
<b>Insulating Material</b>	Cured, flame retardant epoxy polymer meets UL94V-0 requirements.
<b>Device Labeling</b>	LF, Part Number and date code

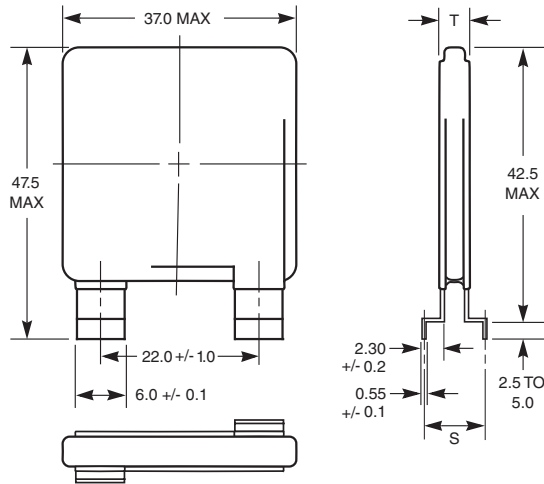
### Environmental Specifications

<b>Operating/Storage Temperature</b>	-55°C to +85°C/-55°C to +125°C
<b>Humidity Aging</b>	+85°C, 85% RH, 1000 hours +/-10% Voltage
<b>Thermal Shock</b>	+85°C to -40°C 10 times +/-10% Voltage
<b>Solvent Resistance</b>	MIL-STD-202, Method 215F
<b>Moisture Sensitivity</b>	Level 1, J-STD-020C



**Dimensions (mm)**

**HB34 Series**

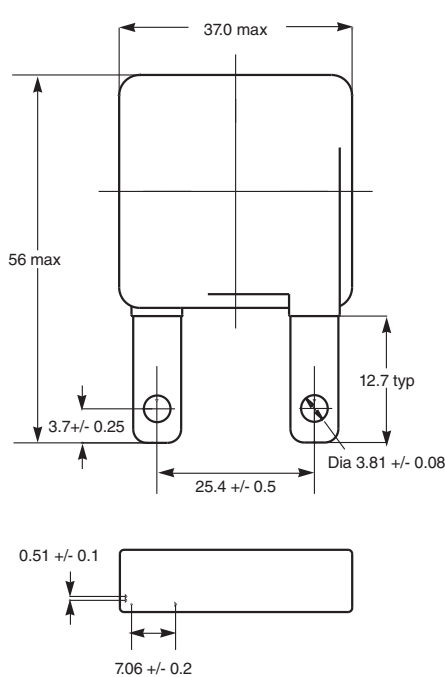


NOTE: Dimension in mm is typical, unless otherwise specified.

**HB34 Series Thickness and Terminal Offset Dimensions**

Part Type	T Body Thickness (Max)	S Mounting Terminal Offset
V111HB34	5.5	5.30 +/- 0.65
V131HB34	5.7	5.50 +/- 0.65
V141HB34	5.8	5.70 +/- 0.65
V151HB34	5.9	5.90 +/- 0.65
V181HB34	6.0	6.10 +/- 0.65
V201HB34	6.0	6.10 +/- 0.65
V251HB34	6.1	6.25 +/- 0.65
V271HB34	6.4	6.50 +/- 0.65
V301HB34	6.7	6.70 +/- 0.65
V321HB34	6.9	6.90 +/- 0.65
V331HB34	7.0	6.95 +/- 0.65
V351HB34	7.3	7.20 +/- 0.85
V391HB34	7.6	7.50 +/- 0.85
V421HB34	7.8	7.85 +/- 0.85
V441HB34	8.0	7.95 +/- 1.00
V481HB34	8.3	8.25 +/- 1.00
V511HB34	8.8	8.60 +/- 1.00
V551HB34	9.1	8.55 +/- 1.5
V571HB34	9.4	8.85 +/- 1.5
V661HB34	10.2	9.65 +/- 1.5
V681HB34	10.4	10.35 +/- 1.5
V751HB34	10.7	10.65 +/- 1.5

**HF34 Series**



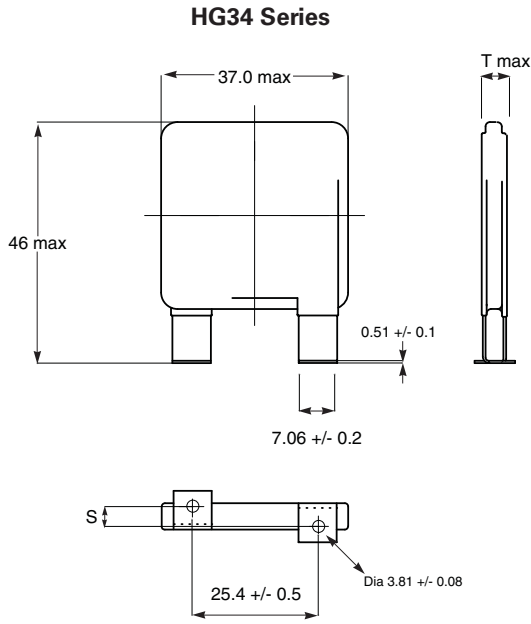
Note: Terminal Material Tin-plated Cover

**HF34 Series Thickness and Terminal Offset Dimensions**

Part Type	T Body Thickness (Max)	S Mounting Terminal Offset
V111HF34	5.5	2.0 +/- 0.65
V131HF34	5.7	2.1 +/- 0.65
V141HF34	5.8	2.2 +/- 0.65
V151HF34	5.9	2.4 +/- 0.65
V181HF34	6.0	2.5 +/- 0.65
V201HF34	6.0	2.6 +/- 0.65
V251HF34	6.1	2.7 +/- 0.85
V271HF34	6.4	2.9 +/- 0.85
V301HF34	6.7	3.2 +/- 0.85
V321HF34	6.9	3.4 +/- 0.85
V331HF34	7.0	3.5 +/- 0.85
V351HF34	7.3	3.9 +/- 0.85
V391HF34	7.6	4.2 +/- 0.85
V421HF34	7.8	4.4 +/- 0.85
V441HF34	8.0	4.5 +/- 0.85
V481HF34	8.3	4.8 +/- 1.0
V511HF34	8.8	5.2 +/- 1.0
V551HF34	9.1	5.5 +/- 1.0
V571HF34	9.4	5.7 +/- 1.5
V661HF34	10.2	6.5 +/- 1.5
V681HF34	10.4	6.7 +/- 1.5
V751HF34	10.7	7.3 +/- 1.5

HBx/HFx/HGx Series

### Dimensions (mm)



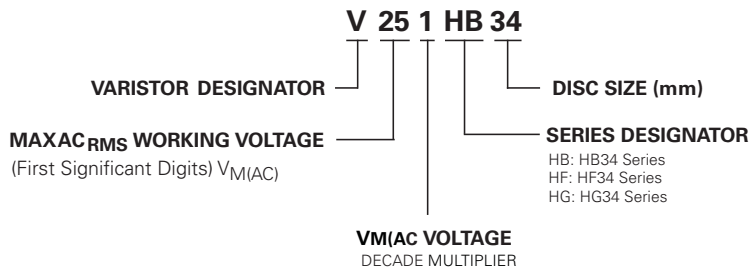
Note: Terminal Material Tin-plated Cover

### HG34 Series Thickness and Terminal Offset Dimensions

Part Type	T Body Thickness (Max)	S Mounting Terminal Offset
V111HG34	5.5	6.0 +/- 0.65
V131HG34	5.7	5.8 +/- 0.65
V141HG34	5.8	5.6 +/- 0.65
V151HG34	5.9	5.5 +/- 0.65
V181HG34	6.0	5.4 +/- 0.65
V201HG34	6.0	5.4 +/- 0.65
V251HG34	6.1	5.2 +/- 0.65
V271HG34	6.4	4.9 +/- 0.65
V301HG34	6.7	4.7 +/- 0.85
V321HG34	6.9	4.5 +/- 0.85
V331HG34	7.0	4.4 +/- 0.85
V351HG34	7.3	4.1 +/- 0.85
V391HG34	7.6	3.8 +/- 0.85
V421HG34	7.8	3.5 +/- 0.85
V441HG34	8.0	3.3 +/- 0.85
V481HG34	8.3	3.1 +/- 1.0
V511HG34	8.8	2.7 +/- 1.0
V551HG34	9.1	2.4 +/- 1.0
V571HG34	9.4	2.2 +/- 1.5
V661HG34	10.2	1.4 +/- 1.5
V681HG34	10.4	1.2 +/- 1.5
V751HG34	10.7	0.6 +/- 1.5

\*Dimensions in mm.

### Part Numbering System





**RoHS (Pb) DHB34 Varistor Series**

**Description**

The DHB34 Series of transient surge suppressors is comprised of two industrial high-energy Metal-Oxide Varistors (MOVs) discs placed in parallel as a single device. They are designed to provide surge suppression in the AC mains outdoor and service entrance environment (distribution panels) of buildings. DHB34 applications also include industrial heavy motors, controls, and power supplies such as used in the oil-drilling, mining, and transportation fields, including HVAC and motor/generator applications.

The DHB34 Series provides rigid terminals for through-hole solder mounting on printed circuit boards, thereby eliminating the need for screw mounting.

**Agency Approvals**

Agency	Agency File Number
	1449, E320116, 1414, E56529
	LR91788

**Features**

- ROHS compliant and Lead-free
- Wide operating voltage range  
 $V_{M(AC)RMS}$  110V to 750V
- High-energy absorption capability  
 $W_{TM}$  = 220J to 1050J
- High peak pulse current (Each of two discs placed in parallel) capability  
 $I_{TM}$  = 40,000A
- Rigid terminals for secure through-hole solder mounting
- No derating up to 85°C ambient
- Dual Disc Device - two 34mm varistor discs in parallel in a single package.

**Absolute Maximum Ratings**

• For ratings of individual members of a series, see Device Ratings and Specifications chart

Continuous	DHB34 Series	Units
Steady State Applied Voltage:		
AC Voltage Range ( $V_{M(AC)RMS}$ )	110 to 750	V
DC Voltage Range ( $V_{M(DC)}$ )	148 to 970	V
Transients:		
Peak Pulse Current ( $I_{TM}$ )		
For 8/20 $\mu$ s Current Wave (See Figure 2)	40000	A
Single Pulse Energy Range		
For 2ms Current Wave ( $W_{TM}$ )	220 to 1050	J
Operating Ambient Temperature Range ( $T_A$ )	-55 to + 85	°C
Storage Temperature Range ( $T_{STG}$ )	-55 to + 125	°C
Temperature Coefficient ( $\alpha^V$ ) of Clamping Voltage ( $V_C$ ) at Specified Test Current	<0.01	%/°C
Hi-Pot Encapsulation (COATING Isolation Voltage Capability)		V
COATING Insulation Resistance		M $\Omega$

**CAUTION:** Stresses above those listed in "Absolute Maximum Ratings" may cause permanent damage to the device. This is a stress only rating and operation of the device at these or any other conditions above those indicated in the operational sections of this specification is not implied.

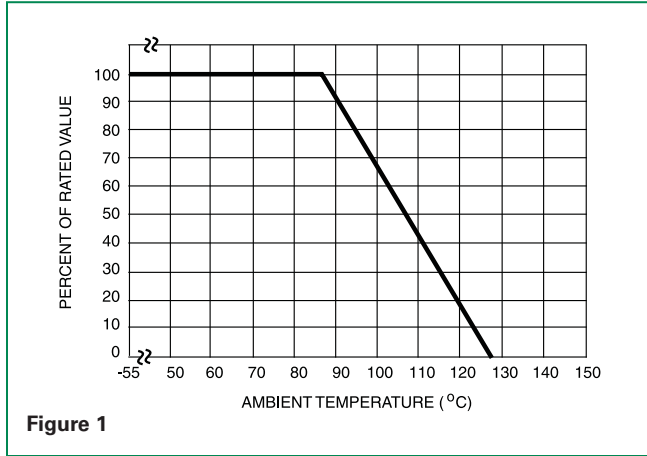
### DHB34 Series Ratings & Specifications

Lead-free and RoHS Compliant Models	Model Size Disc Dia. (mm)	Maximum Rating (85°C)				Specifications (25°C)				
		Continuous		Transient		Varistor Voltage at 1mA DC Test Current			Maximum Clamping Voltage $V_C$ at 200A Current (8/20 $\mu$ s)	Typical Capacitance
		$V_{RMS}$	$V_{DC}$	Energy (2ms)	Peak Current 8 x 20 $\mu$ s					
		Part Number	$V_{M(AC)}$ (V)	$V_{M(DC)}$ (V)	$W_{TM}$ (J)	$I_{TM}$ (A)	Min (V)	$V_{N(DC)}$ (V)	Max (V)	$V_C$ (V)
V111DHB34	34	110	148	220	40,000 <sup>1</sup>	156	173	190	288	11,600
V131DHB34	34	130	175	270	40,000 <sup>2</sup>	184	200	228	345	10,000
V141DHB34	34	140	188	291	40,000 <sup>3</sup>	198	220	248	375	9,000
V151DHB34	34	150	200	300	40,000 <sup>4</sup>	212	240	268	405	8,000
V181DHB34	34	180	240	330	40,000	254	282	310	468	6,800
V201DHB34	34	200	265	350	40,000	283	314	345	533	6,350
V251DHB34	34	250	330	370	40,000	354	390	429	650	5,000
V271DHB34	34	275	369	400	40,000	389	430	473	730	4,500
V301DHB34	34	300	410	430	40,000	433	478	526	780	4,100
V321DHB34	34	320	420	460	40,000	462	510	561	830	3,800
V331DHB34	34	330	435	475	40,000	467	519	570	843	3,750
V351DHB34	34	350	460	500	40,000	495	550	604	894	3,600
V391DHB34	34	385	510	550	40,000	545	604	663	1,000	3,500
V421DHB34	34	420	560	600	40,000	610	680	748	1,130	3,000
V441DHB34	34	440	585	630	40,000	622	691	759	1,147	2,900
V481DHB34	34	480	640	650	40,000	670	750	825	1,240	2,700
V511DHB34	34	510	675	700	40,000	735	820	910	1,350	2,500
V551DHB34	34	550	710	755	40,000	778	864	949	1,404	2,390
V571DHB34	34	575	730	770	40,000	805	910	1000	1,480	2,200
V661DHB34	34	660	850	900	40,000	940	1050	1160	1,720	2,000
V681DHB34	34	680	875	925	40,000	962	1068	1173	1,777	1,900
V751DHB34	34	750	970	1050	40,000	1080	1200	1320	2,000	1,800

Note:

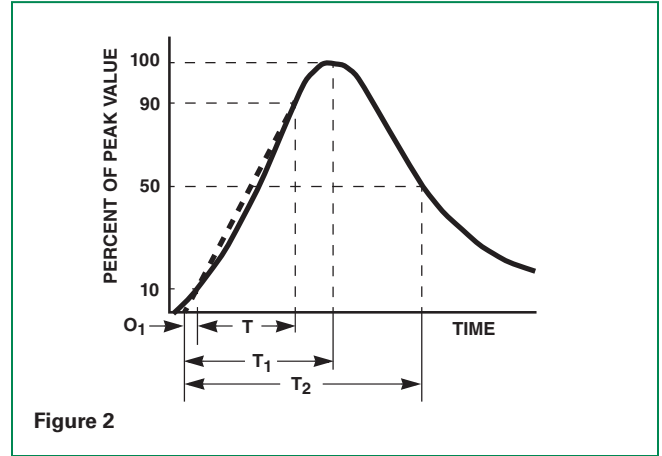
1. 40kA capability depends on applications rated up to 97V<sub>RMS</sub>. 30kA applies if > 97 V<sub>RMS</sub>.
2. 40kA capability depends on applications rated up to 115V<sub>RMS</sub>. 30kA applies if > 115 V<sub>RMS</sub>.
3. 40kA capability depends on applications rated up to 123V<sub>RMS</sub>. 30kA applies if > 123 V<sub>RMS</sub>.
4. 40kA capability depends on applications rated up to 132V<sub>RMS</sub>. 30kA applies if > 132 V<sub>RMS</sub>.

**Power Dissipation Ratings**



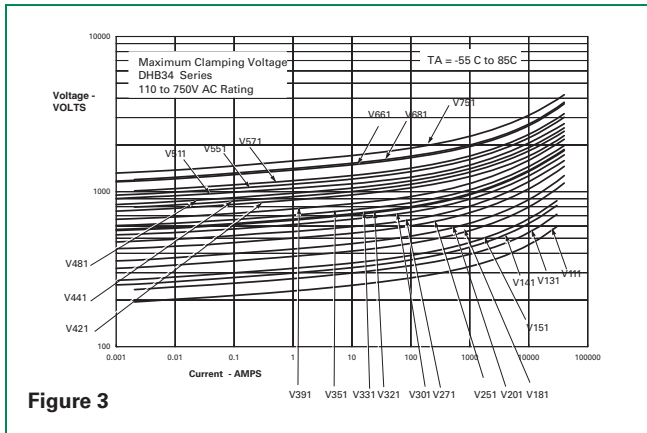
Should transients occur in rapid succession, the average power 100 dissipation result is simply the energy (watt-seconds) per pulse times the number of pulses per second. The power so developed must be within the specifications shown on the Device Ratings and Specifications table for the specific device. The operating values must be derated as shown in above.

**Peak Pulse Current Test Waveform**

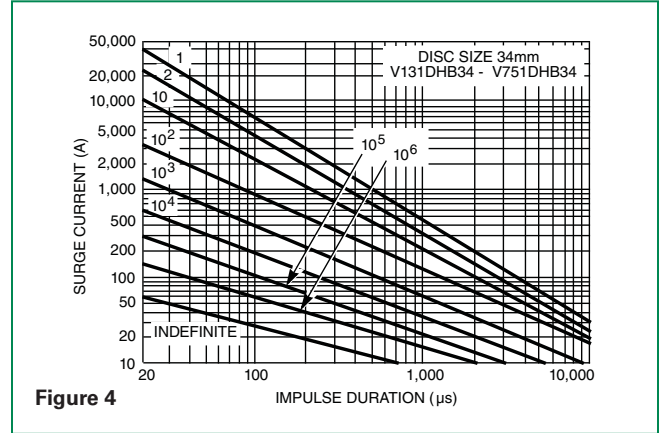


$O_1$  = Virtual Origin of Wave  
 $T$  = Time from 10% to 90% of Peak  
 $T_1$  = Rise Time =  $1.25 \times T$   
 $T_2$  = Decay Time  
**Example** - For an  $8/20 \mu s$  Current Waveform:  
 $8 \mu s = T_1 = \text{Rise Time}$   
 $20 \mu s = T_2 = \text{Decay Time}$

**Maximum Clamping Voltage**



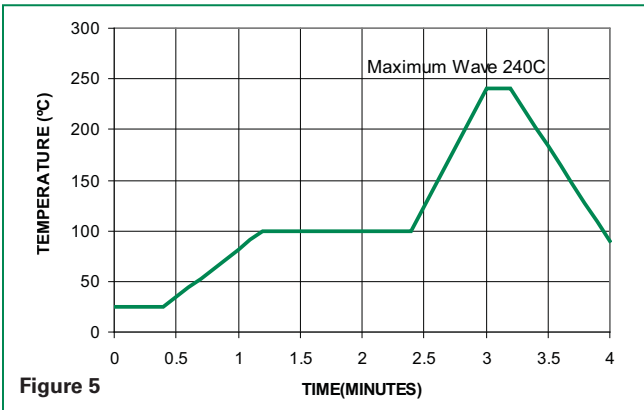
**Repetitive Surge Capability**



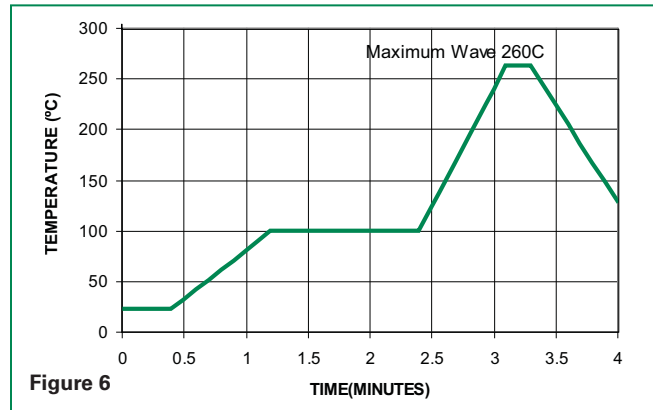
NOTE: If pulse ratings are exceeded, a shift of  $V_{NIDC}$  (at specified current) of more than +/-10% could result. This type of shift, which normally results in a decrease of  $V_{NIDC}$ , may result in the device not meeting the original published specifications, but it does not prevent the device from continuing to function, and to provide ample protection.

### Soldering Parameters

#### Non Lead-free Profile



#### Lead-free Profile



Reflow Condition		Pb – Free assembly
Pre Heat	- Temperature Min (Ts(min))	150°C
	- Temperature Max (Ts(max))	200°C
	- Time (min to max) (ts)	60 – 180 secs
Average ramp up-rate (Liquidus Temp (TL) to peak)		5°C/second max
TS(max) to TL - Ramp-up Rate		5°C/second max
Reflow	- Temperature (TL) (Liquidus)	217°C
	- Temperature (tL)	60 – 150 seconds
Peak Temperature (TP)		250 <sup>+0/-5</sup> °C
Time within 5°C of actual peak Temperature (tp)		20 – 40 seconds
Ramp-down Rate		5°C/second max
Time 25°C to peak Temperature (TP)		8 minutes Max.
Do not exceed		260°C

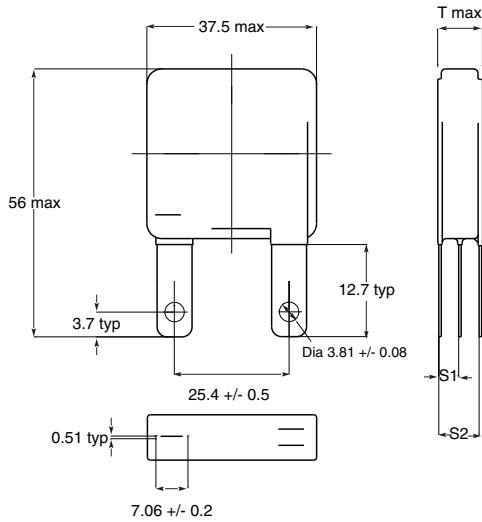
#### Physical Specifications

<b>Lead Material</b>	Tin-coated Copper
<b>Soldering Characteristics</b>	Solderability per MIL-STD-202, Method 208E
<b>Insulating Material</b>	Cured, flame retardant epoxy polymer meets UL94V-0 requirements.
<b>Device Labeling</b>	Marked with LF, voltage, amperage rating, and date code.

#### Environmental Specifications

<b>Operating/Storage Temperature</b>	-55°C to +85°C/-55°C to +125°C
<b>Humidity Aging</b>	+85°C, 85% RH, 1000 hours +/-10% Voltage change
<b>Thermal Shock</b>	+85°C to -40°C 10 times +/-10% Voltage change
<b>Solvent Resistance</b>	MIL-STD-202, Method 215F
<b>Moisture Sensitivity</b>	Level 1, J-STD-020C

**Dimensions (mm)**

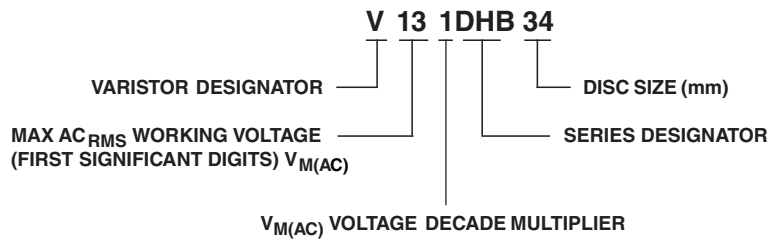


NOTE: Dimension in mm is typical, unless otherwise specified.

**Table of Dimensions - Thickness and Terminal Offsets**

Part Type	T Max	S1 +/- 1.15 mm	S2 +/- 2.30mm
V111DHB34	7.6	2.65	5.50
V131DHB34	7.8	2.85	5.70
V141DHB34	8.2	3.00	6.00
V151DHB34	8.8	3.15	6.30
V181DHB34	9.0	3.25	6.50
V201DHB34	9.2	3.35	6.70
V251DHB34	9.10	3.00	6.00
V271DHB34	9.55	3.25	6.50
V301DHB34	10.20	3.50	7.00
V321DHB34	10.60	3.66	7.24
V331DHB34	10.65	3.70	7.40
V351DHB34	10.5	4.10	8.20
V391DHB34	11.2	4.45	8.90
V421DHB34	12.65	4.50	9.00
V441DHB34	12.80	4.55	9.10
V481DHB34	13.55	4.80	9.60
V511DHB34	13.4	5.25	10.50
V551DHB34	14.6	5.70	11.40
V571DHB34	14.8	5.80	11.60
V661DHB34	17.20	6.65	13.30
V681DHB34	17.5	7.00	14.00
V751DHB34	18.20	7.35	14.70

**Part Numbering System**

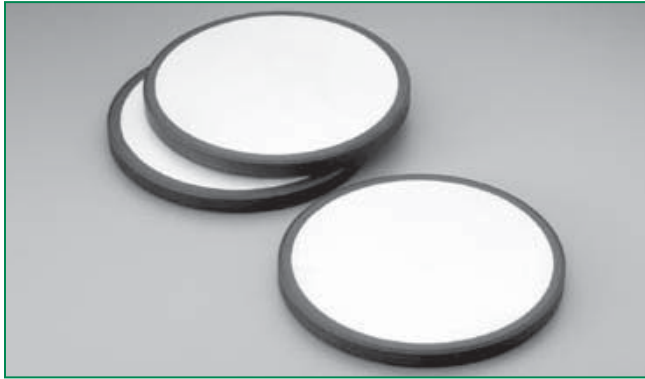


**DHB34 Series**





### CA Varistor Series



#### Description

The CA Series of transient surge suppressors are industrial high-energy disc varistors (MOVs) intended for special applications requiring unique electrical contact or packaging methods provided by the customer. The electrode finish of these devices is solderable and can also be used with pressure contacts. Discs of the same diameter may be stacked.

This series of industrial disc varistors are nominal 60mm diameter, with disc thickness ranging from 2.0mm minimum to 32mm maximum. The voltage range is 250V to 2800 V<sub>(AC)RMS</sub>.

For information on soldering considerations, refer to EC637 "Recommendations for Soldering Terminal Leads to MOV Varistor Discs."

#### Features

- Standard disc size nominal 60mm diameter
- Discs have edge passivation insulation
- High peak pulse current range 50000A to 70000A
- Very high-energy capability W<sub>tm</sub> 880J to 10000J

#### Absolute Maximum Ratings

• For ratings of individual members of a series, see Device Ratings and Specifications chart

Continuous	CA Series	Units
Steady State Applied Voltage:		
AC Voltage Range (V <sub>M(AC)RMS</sub> )	250 to 2800	V
DC Voltage Range (V <sub>M(DC)</sub> )	330 to 3500	V
Transient:		
Peak Pulse Current (I <sub>TM</sub> )		
For 8/20μs Current Wave(See Figure 2)	20,000 to 70,000	A
Single-Pulse Energy Range		
For 2ms Current Square Wave (W <sub>TM</sub> )	880 to 10,000	J
Operating Ambient Temperature Range (T <sub>A</sub> )	-55 to +85	°C
Storage Temperature Range (T <sub>STG</sub> )	- 55 to +85	°C
Temperature Coefficient (V) of Clamping Voltage (V <sub>C</sub> ) at Specified Test Current	<0.01	%/°C

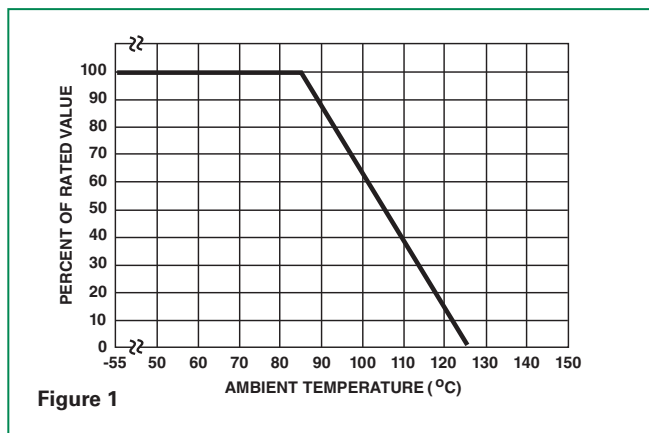
**CAUTION:** Stresses above those listed in "Absolute Maximum Ratings" may cause permanent damage to the device. This is a stress only rating and operation of the device at these or any other conditions above those indicated in the operational sections of this specification is not implied.

### CA Series Ratings & Specifications

Part Number Device Branding	Size  (mm)	Maximum Rating (85°C)				Specifications (25°C)				
		Continuous		Transient		Varistor Voltage at 1mA DC Test Current			Max Clamping Volt V <sub>c</sub> at 200A Current (8/20μs)	Typical Capacitance  f = 1MHz
		V <sub>RMS</sub>	V <sub>DC</sub>	Energy (2ms)	Peak Current (8/20μs)					
		V <sub>M(AC)</sub> (V)	V <sub>M(DC)</sub> (V)	W <sub>TM</sub> (J)	I <sub>TM</sub> (A)	Min (V)	V <sub>NOM</sub> (V)	Max (V)	V <sub>c</sub> (A)	(pF)
V251CA60	60	250	330	880	50000	354	390	429	620	10000
V271CA60	60	275	369	950	50000	389	430	473	680	9000
V321CA60	60	320	420	1100	50000	462	510	561	760	7500
V421CA60	60	420	560	1500	70000	610	680	748	1060	6000
V481CA60	60	480	640	1600	70000	670	750	825	1160	5500
V511CA60	60	510	675	1800	70000	735	820	910	1300	5000
V571CA60	60	575	730	2100	70000	805	910	1000	1420	4500
V661CA60	60	660	850	2300	70000	940	1050	1160	1640	4000
V751CA60	60	750	970	2600	70000	1080	1200	1320	1880	3500
V881CA60	60	880	1150	3200	70000	1290	1500	1650	2340	2700
V112CA60	60	1100	1400	3800	70000	1620	1800	2060	2940	2200
V142CA60	60	1400	1750	5000	70000	2020	2200	2550	3600	1800
V172CA60	60	1700	2150	6000	70000	2500	2700	3030	4300	1500
V202CA60	60	2000	2500	7500	70000	2970	3300	3630	5200	1200
V242CA60	60	2400	3000	8800	70000	3510	3900	4290	6200	1000
V282CA60	60	2800	3500	10000	70000	4230	4700	5170	7400	800

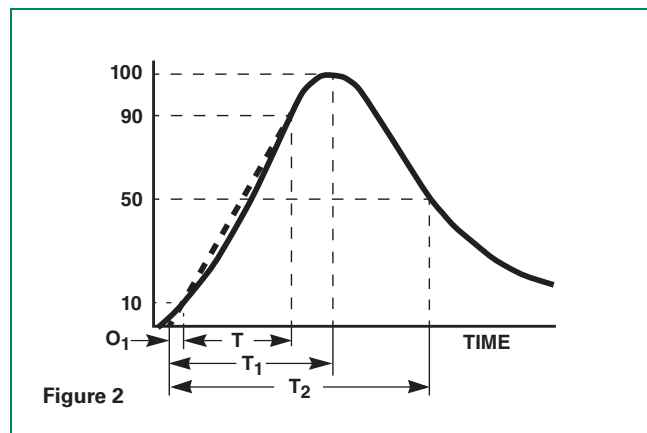
NOTE: Average power dissipation of transients should not exceed 2.5W for CA60 discs.

### Power Dissipation Ratings



Should transients occur in rapid succession, the average power dissipation result is the energy (watt-seconds) per pulse times the number of pulses per second. The power so developed must be within the specifications shown on the Device Ratings and Specifications table for the specific device. Furthermore, the operating values need to be derated at high temperatures as shown in above. Because varistors can only dissipate a relatively small amount of average power they are, therefore, not suitable for repetitive applications that involve substantial amounts of average power dissipation.

### Peak Pulse Current Test Waveform



- O<sub>1</sub> = Virtual Origin of Wave
- T = Time from 10% to 90% of Peak
- T<sub>1</sub> = Rise Time = 1.25 x T
- T<sub>2</sub> = Decay Time

**Example** - For an 8/20 μs Current Waveform:

- 8μs = T<sub>1</sub> = Rise Time
- 20μs = T<sub>2</sub> = Decay Time

**Maximum Clamping Voltage for 60mm Parts**

V251CA60 - V881CA60

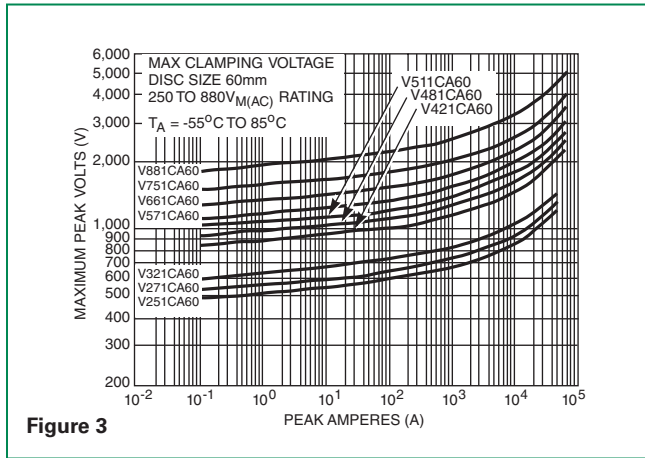


Figure 3

**Repetitive Surge Capability for 60mm Parts**

V251CA60 - V321CA60

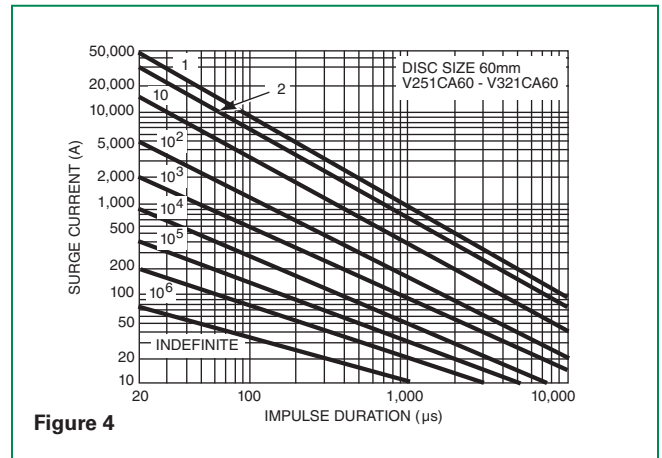


Figure 4

V112CA60 - V282CA60

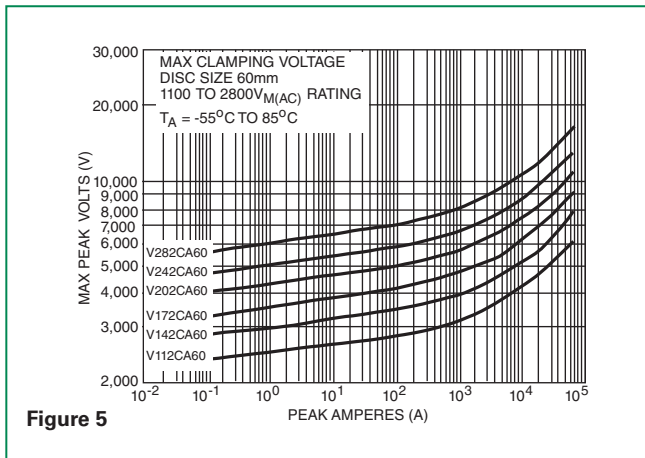


Figure 5

V421CA60 - V282CA60

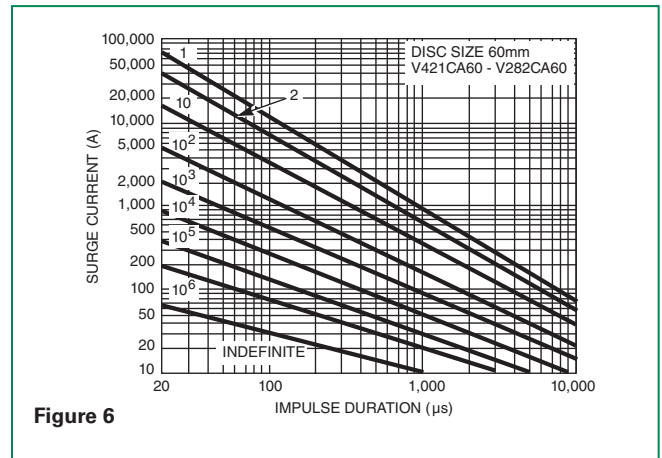


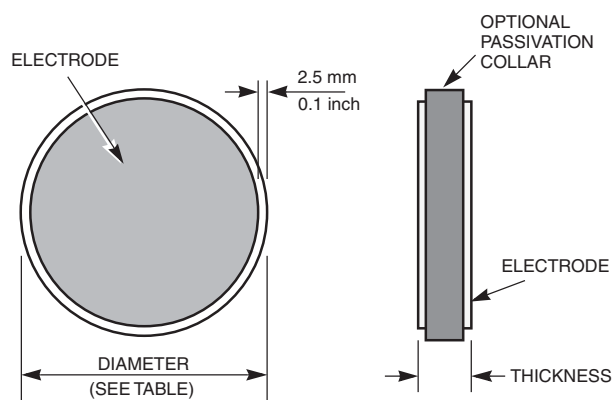
Figure 6

NOTE: If pulse ratings are exceeded, a shift of  $V_{NDC}$  (at specified current) of more than +/-10% could result. This type of shift, which normally results in a decrease of  $V_{NDC}$ , may result in the device not meeting the original published specifications, but does not prevent the device from continuing to function, and to provide ample protection.

### Physical Specifications

<b>Soldering Characteristics</b>	Solderability per MIL-STD-202, Method 208E
<b>Insulating Material</b>	glass passivation on edge only
<b>Device Labeling</b>	none

### Product Dimensions (mm)



### Environmental Specifications

<b>Operating/Storage Temperature</b>	-55°C to +85°C
<b>Humidity Aging</b>	+85°C, 85% RH, 1000 hours +/-10% typical voltage change
<b>Thermal Shock</b>	+85°C to -55°C 10 times +/-10% typical voltage change
<b>Solvent Resistance</b>	MIL-STD-202, Method 215F
<b>Moisture Sensitivity</b>	Level 1, J-STD-020C

### Weight

Model Number	Typical Discweight (Grams)
V251CA60	39
V271CA60	42
V321CA60	50
V421CA60	66
V481CA60	71
V511CA60	80
V571CA60	88
V661CA60	101
V751CA60	116
V881CA60	141
V112CA60	178
V142CA60	220
V172CA60	265
V202CA60	317
V242CA60	377
V282CA60	450

Model Size	Disc Diameter			
	Millimeters		Inches	
	Min	Max	Min	Max
60	58.0	62.0	2.283	2.441

Model $V_{RMS}$ $V_{M(AC)}$	Disc Thickness			
	Millimeters		Inches	
	Min.	Max.	Min.	Max.
250	2.0	2.7	0.079	0.106
275	2.2	3.0	0.087	0.118
320	2.6	3.5	0.102	0.138
420	3.5	4.7	0.138	0.185
510	4.2	5.7	0.165	0.224
575	4.6	6.3	0.181	0.248
660	5.3	7.2	0.209	0.283
750	6.1	8.3	0.240	0.327
880	7.3	10.3	0.287	0.406
1100	9.2	13.0	0.362	0.512
1400	11.5	16.0	0.453	0.630
1700	14.0	19.0	0.551	0.748
2000	17.0	22.5	0.669	0.886
2400	20.0	27.0	0.787	1.063
2800	24.0	32.0	0.945	1.260

### Passivation Layer

The standard CA Series is supplied with passivation layer around the outside perimeter of the disc forming an electrical insulator as detailed in the dimensional drawing. For other options contact factory. (See Ordering Information)

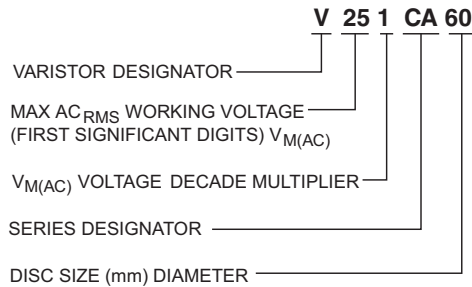
### Encapsulated Recommendations

After lead attachment, the disc/lead assembly may be coated or encapsulated in a package to provide electrical insulation and isolation from environmental contamination as required by the application. Coating/Filler materials for containers may include silicones, polyurethanes, and some epoxy resins. Materials containing halogens, sulfides, or alkalines are not recommended.

### Stacking and Contact Pressure Recommendations

When applications require the stacking of CA60 discs, or when an electrical connection is made by pressure contacts, the pressure applied to the CA60 disc electrode surface should be minimum 2.2kgs (5 pounds) and maximum 4N/CM<sup>2</sup> (5.7LBs/IN<sup>2</sup>).

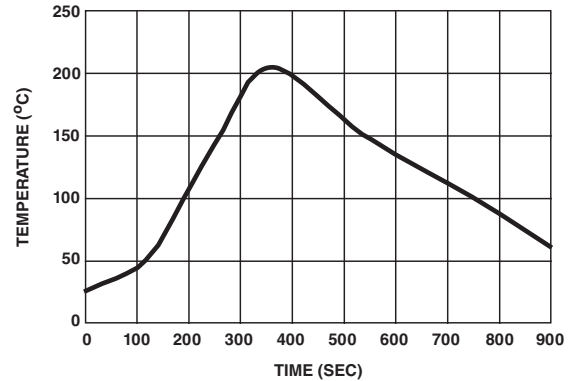
### Part Numbering System



### Electrode Metallization

CA60 discs are supplied as standard with sintered Silver electrodes. For other available options please contact Littelfuse.

### Recommended Reflow Temperature Profile



### Packaging and Shipping

The CA Series is supplied in bulk for shipment. Discs are packaged in compartmentalized cartons to protect from scratching or edge-chipping during shipment.

No branding or any other type of marking appears on the CA disc itself.

CA60 discs are supplied as standard with sintered Silver electrodes and glass passivation. For other available options please contact factory.



RoHS  **MA Varistor Series**



**Description**

The MA Series of transient surge suppressors are axial lead Metal Oxide Varistors (MOVs) for use in a wide variety of board level industrial and commercial electronic equipment. They are intended to protect components and signal/data lines from low energy transients where the small axial lead package is required.

The MA Series is offered with standard ('S' suffix) or tightened ('B' suffix) clamping voltage.

See MA Series Device Ratings and Specifications Table for part number and brand information.

**Features**

- 3mm diameter disc size
- Small axial lead package
- Wide operating voltage range:  
 $V_{M(AC)RMS}$  9V to 264V  
 $V_{M(DC)}$  13V to 365V
- Available in tape and reel or bulk packaging
- No derating up to 85°C ambient
- New black epoxy offers improved performance for high temperature Lead-free wave soldering process.

**Agency Approvals**

Agency	Agency File Number
	None

**Absolute Maximum Ratings**

• For ratings of individual members of a series, see Device Ratings and Specifications chart

Continuous	MA Series	Units
Steady State Applied Voltage:		
AC Voltage Range ( $V_{M(AC)RMS}$ )	9 to 264	V
DC Voltage Range ( $V_{M(DC)}$ )	13 to 365	V
Transient:		
Peak Pulse Current ( $I_{TM}$ )		
For 8/20 $\mu$ s Current Wave(See Figure 2)	40 to 100	A
Single-Pulse Energy Range		
For 2ms Current Square Wave ( $W_{TM}$ )	0.06 to 1.7	J
Operating Ambient Temperature Range ( $T_A$ )	-55 to +85	°C
Storage Temperature Range ( $T_{STG}$ )	-55 to +125	°C
Temperature Coefficient ( $\alpha V$ ) of Clamping Voltage ( $V_C$ ) at Specified Test Current	<0.01	%/°C
Hi-Pot Encapsulation (COATING Isolation Voltage Capability) Dielectric must withstand indicated DC voltage for one minute per MIL-STD 202, Method 301)		
COATING Insulation Resistance	1000	M $\Omega$

**CAUTION:** Stresses above those listed in "Absolute Maximum Ratings" may cause permanent damage to the device. This is a stress only rating and operation of the device at these or any other conditions above those indicated in the operational sections of this specification is not implied.

MA Series

### MA Series Ratings & Specifications

Part Number	Brand (mm)	Maximum Rating (85°C)				Specifications (25°C)				
		Continuous		Transient		Varistor Voltage at 1mA DC Test Current			Max Clamping Volt $V_C$ at 2.0A (8/20 $\mu$ s)	Typical Capacitance
		$V_{RMS}$	$V_{DC}$	Energy (10/1000 $\mu$ s)	Peak Current (8/20 $\mu$ s)					
		$V_{M(AC)}$	$V_{M(DC)}$	$W_{TM}$	$I_{TM}$	Min	$V_{N(DC)}$	Max	$V_C$	$f = 1\text{MHz}$
(V)	(V)	(J)	(A)	(V)	(V)	(V)	(A)	(pF)		
V18MA1A	18A	9	13	0.06	40	14	18	23	49	550
V18MA1A	18B	10	14	0.07	40	15	18	21	44	550
V18MA1A	18C	10	14	0.06	40	15	18	21	49	550
V22MA1A	22A	10	15	0.09	40	16	22	28	55	410
V22MA1B	22B	14	18	0.10	40	19	22	26	51	410
V22MA1S	22S	14	18	0.09	40	19	22	26	55	410
V27MA1A	27A	13	19	0.10	40	21	27	34	67	370
V27MA1B	27B	17	22	0.11	40	24	27	31	59	370
V27MA1S	27S	17	22	0.10	40	24	27	31	67	370
V33MA1A	33A	18	23	0.13	40	26	33	40	73	300
V33MA1B	33B	20	26	0.15	40	29.5	33	36.5	67	300
V33MA1S	33S	20	26	0.14	40	29.5	33	36.5	73	300
V39MA2A	39A	22	28	0.16	40	31	39	47	86	250
V39MA2B	39B	25	31	0.18	40	35	39	43	79	250
V39MA2S	39S	25	31	0.17	40	35	39	43	86	250
V47MA2A	47A	27	34	0.19	40	37	47	57	99	210
V47MA2B	47B	30	38	0.21	40	42	47	52	90	210
V47MA2S	47S	30	38	0.19	40	42	47	52	99	210
V56MA2A	56A	32	40	0.23	40	44	56	68	117	180
V56MA2B	56B	35	45	0.25	40	50	56	62	108	180
V56MA2S	56S	35	45	0.23	40	50	56	62	117	180
V68MA3A	68A	38	48	0.26	40	54	68	82	138	150
V68MA3B	68B	40	56	0.30	40	61	68	75	127	150
V68MA3S	68S	40	56	0.27	40	61	68	75	138	150
V82MA3A	82A	45	60	0.33	40	65	82	99	163	120
V82MA3B	82B	50	66	0.37	40	73	82	91	150	120
V82MA3S	82S	50	66	0.34	40	73	82	91	163	120
V100MA4A	100	57	72	0.40	40	80	100	120	200	100
V100MA4B	101	60	81	0.45	40	90	100	110	185	100
V100MA4S	102	60	81	0.42	40	90	100	110	200	100
V120MA1A	120	72	97	0.40	100	102	120	138	220	40
V120MA2B	121	75	101	0.50	100	108	120	132	205	40
V120MA2S	122	75	101	0.46	100	108	120	132	220	40
V150MA1A	150	88	121	0.50	100	127	150	173	255	32
V150MA2B	151	92	127	0.60	100	135	150	165	240	32
V180MA1A	180	105	144	0.60	100	153	180	207	310	27
V180MA3B	181	110	152	0.70	100	162	180	198	290	27
V220MA2A	220	132	181	0.80	100	187	220	253	380	21
V220MA4B	221	138	191	0.90	100	198	220	242	360	21
V270MA2A	270	163	224	0.90	100	229	270	311	460	17
V270MA4B	271	171	235	1.00	100	243	270	297	440	17
V330MA2A	330	188	257	1.00	100	280	330	380	570	14
V330MA5B	331	200	274	1.10	100	297	330	363	540	14
V390MA3A	390	234	322	1.20	100	331	390	449	670	12
V390MA6B	391	242	334	1.30	100	351	390	429	640	12
V430MA3A	430	253	349	1.50	100	365	430	495	740	11
V430MA7B	431	264	365	1.70	100	387	430	473	700	11

NOTE: Average power dissipation of transients not to exceed 200mW.



**Power Dissipation Ratings**

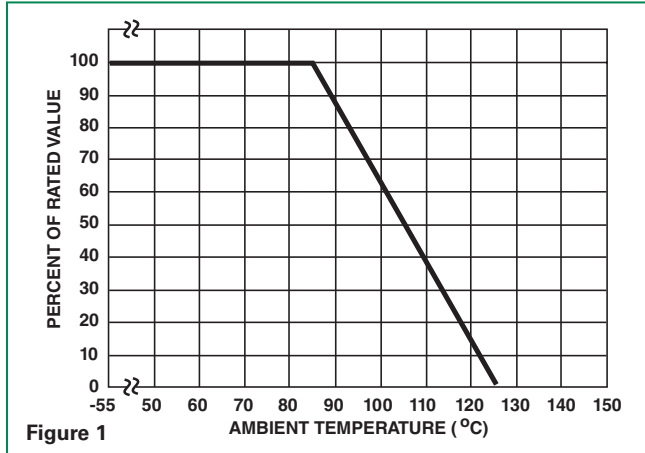


Figure 1

Should transients occur in rapid succession, the average power dissipation required is simply the energy (watt-seconds) per pulse times the number of pulses per second. The power so developed must be within the specifications shown on the Device Ratings and Specifications table for the specific device. Furthermore, the operating values need to be derated at high temperatures as shown above. Because varistors can only dissipate a relatively small amount of average power they are, therefore, not suitable for repetitive applications that involve substantial amounts of average power dissipation.

**Peak Pulse Current Test Waveform**

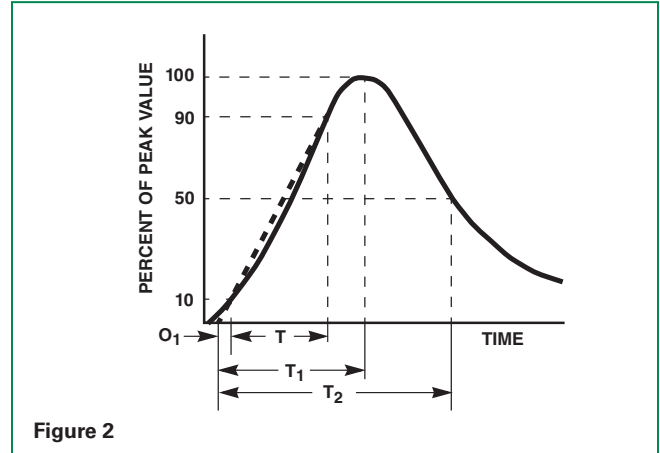


Figure 2

- $O_1$  = Virtual Origin of Wave
- $T$  = Time from 10% to 90% of Peak
- $T_1$  = Rise Time =  $1.25 \times T$
- $T_2$  = Decay Time
- Example** - For an  $8/20 \mu s$  Current Waveform:  
 $8 \mu s = T_1 = \text{Rise Time}$   
 $20 \mu s = T_2 = \text{Decay Time}$

**Repetitive Surge Capability**

**V18MA - V100MA**

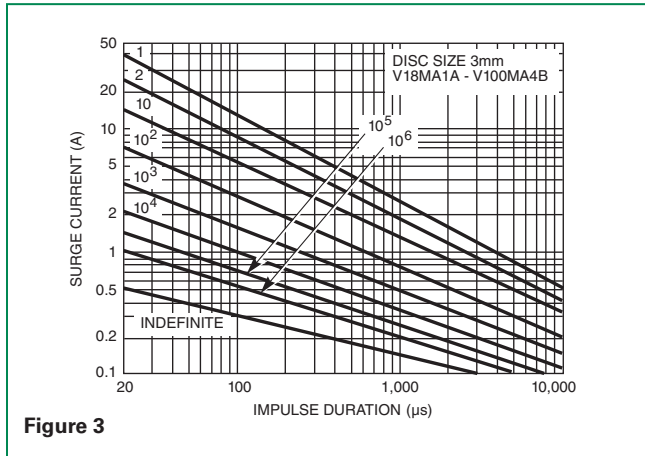


Figure 3

**V120MA1A/S - V430MA3A**

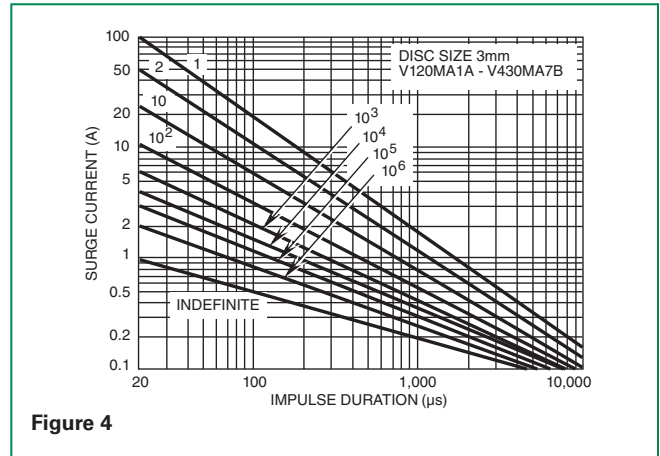
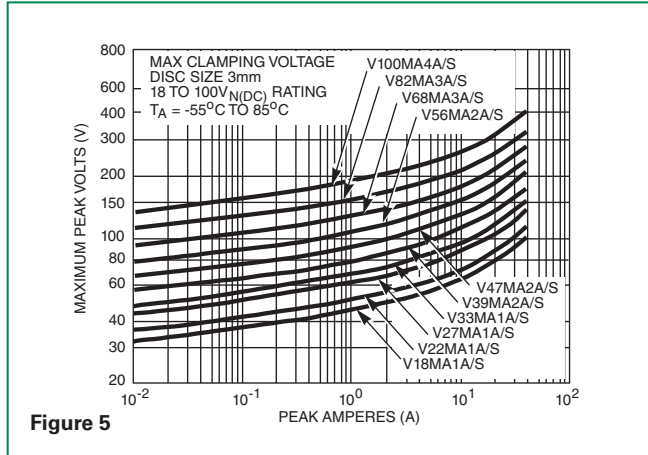


Figure 4

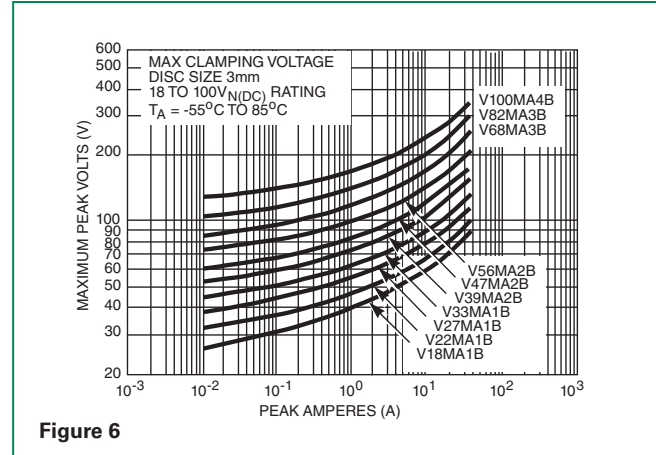
NOTE: If pulse ratings are exceeded, a shift of  $V_{NIDG}$  (at specified current) of more than +/-10% could result. This type of shift, which normally results in a decrease of  $V_{NIDG}$ , may result in the device not meeting the original published specifications, but it does not prevent the device from continuing to function, and to provide ample protection.

### Maximum Clamping Voltage

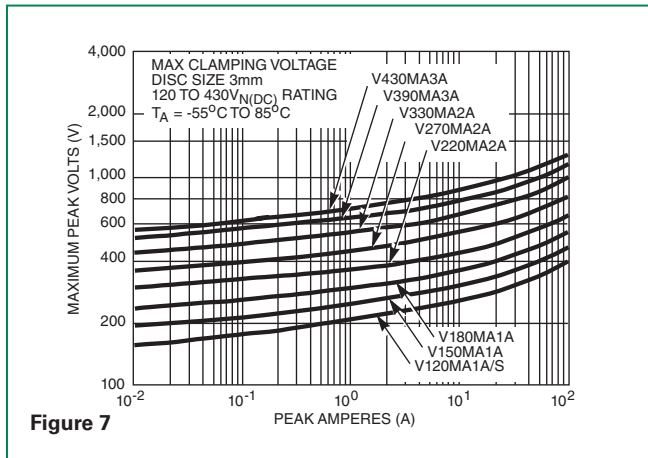
V18MA1A/S - V100MA4A/S



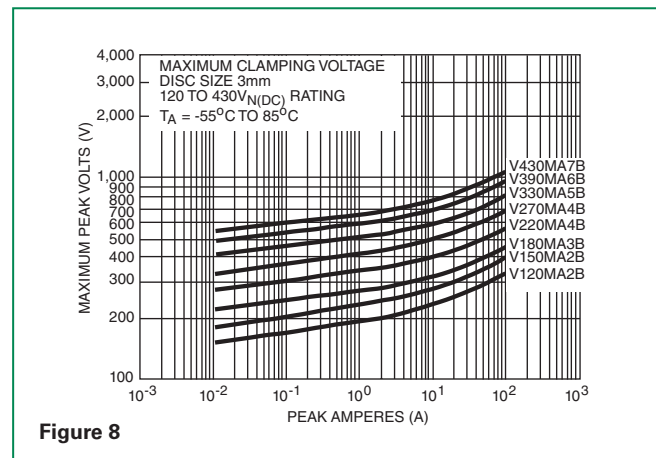
V18MA1B - V100MA4B



V120MA1A/S - V430MA3A

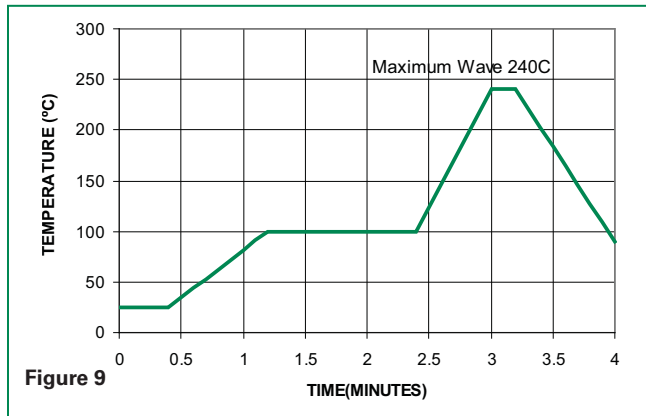


V120MA2B - V430MA7B

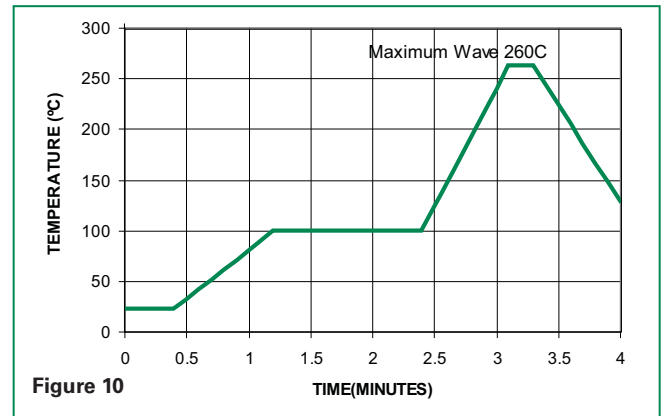


### Wave Solder Profile

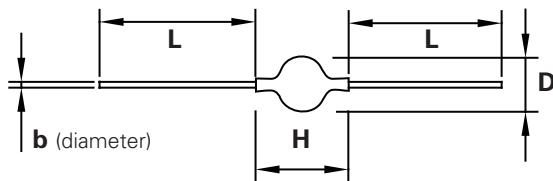
#### Non Lead-free Profile



#### Lead-free Profile



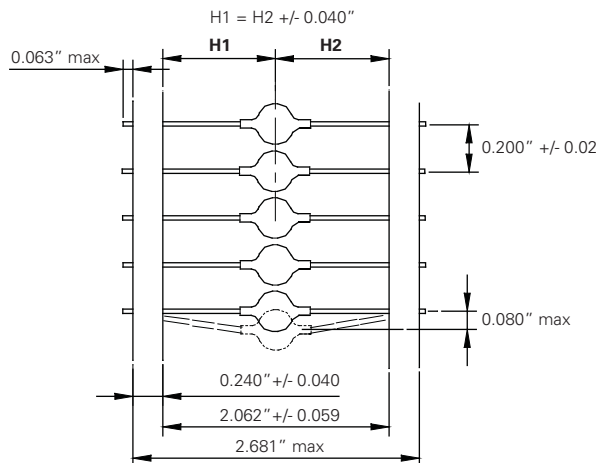
### Product Dimensions



Symbol	Inches		Millimeters	
	Min	Max	Min	Max
Øb	0.024	0.026	0.61	0.66
ØD	0.118	0.177	3.0	4.5
H	0.177	0.276	4.5	7.0
L	1.740	1.220	27.3	31.0

Typical Weight = 0.5g

### Tape and Reel Dimensions



Conforms to EIA Standard RS-296-E

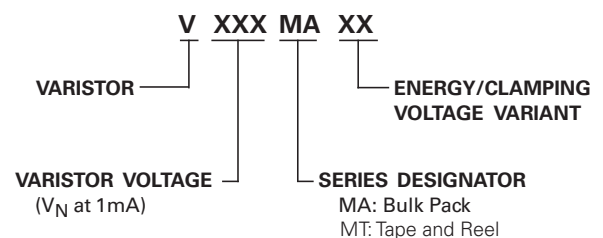
### Physical Specifications

<b>Lead Material</b>	Tin-plated Copper clad steel
<b>Soldering Characteristics</b>	Solderability per MIL-STD-202, Method 208E
<b>Insulating Material</b>	Cured, flame retardant epoxy polymer meets UL94V-0 requirements
<b>Device Labeling</b>	Marked with LF, voltage and date code

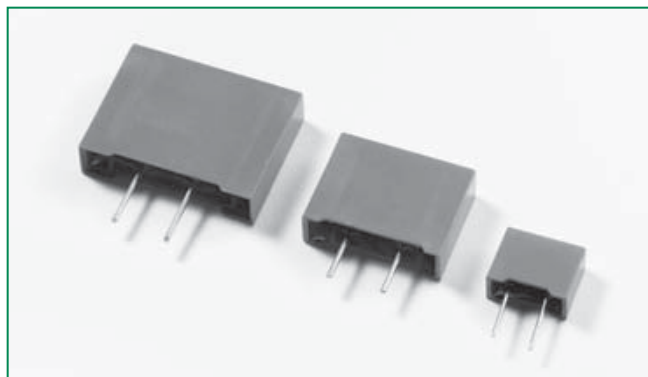
### Environmental Specifications

<b>Operating/Storage Temperature</b>	-40°C to +85°C
<b>Passive Aging</b>	+85°C, 1000 hours +/-10% typical voltage change
<b>Humidity Aging</b>	+85°C, 85% RH, 1000 hours +/-10% typical voltage change
<b>Thermal Shock</b>	+85°C to -40°C 5 times +/-10% typical voltage change
<b>Solvent Resistance</b>	MIL-STD-202, Method 215F
<b>Moisture Sensitivity</b>	Level 1, J-STD-020C

### Part Numbering System







**RoHS (Pb) RA Varistor Series**

**Description**

The RA Series transient surge suppressors are varistors (MOVs) supplied in a low-profile box that features a precise seating plane to increase mechanical stability for secure circuit-board mounting. This feature makes these devices suitable for industrial applications critical to vibration. Their construction permits operation up to 125°C (ambient) without derating.

The RA Series are available in voltage ratings up to 275V  $V_{M(AC)RMS}$  and energy levels up to 140J. These varistors are used in automotive, motor-control, telecommunication, and military applications.

See RA Series Device Ratings and Specifications Table for part number and brand information.

**Agency Approvals**

Agency	Agency File Number
	E320116
	LR91788

**Features**

- Lead-free/RoHS compliant parts available (add suffix "x2749")
- Low profile outline with precise seating plane
- No derating up to 125°C ambient
- In-line leads
- Wide operating voltage range:  
 $V_{M(AC)RMS}$ : 4 – 275V  
 $V_{M(DC)}$ : 5.5 – 369V
- High energy absorption capability  $W_{TM}$  up to 140J
- 3 model sizes available A8, RA16, and RA22

**Absolute Maximum Ratings**

• For ratings of individual members of a series, see Device Ratings and Specifications chart

Continuous	RA8 Series	RA16 Series	RA22 Series	Units
Steady State Applied Voltage:				
AC Voltage Range ( $V_{M(AC)RMS}$ )	4 to 275	10 to 275	4 to 275	V
DC Voltage Range ( $V_{M(DC)}$ )	5.5 to 369	14 to 369	18 to 369	V
Transients:				
Peak Pulse Current ( $I_{TM}$ )				
For 8/20 $\mu$ s Current Wave (See Figure 2)	100 to 1200	1000 to 4500	2000 to 6500	A
Single Pulse Energy Range (Note 1)				
For 10/1000 $\mu$ s Current Wave ( $W_{TM}$ )	0.4 to 23	3.5 to 75	70 to 160	J
Operating Ambient Temperature Range ( $T_A$ )	-55 to +125	-55 to +125	-55 to +125	°C
Storage Temperature Range ( $T_{STG}$ )	-55 to +150	-55 to +150	-55 to +150	°C
Temperature Coefficient ( $\alpha$ ) of Clamping Voltage ( $V_c$ ) at Specified Test Current	<0.01	<0.01	<0.01	%/°C
Hi-Pot Encapsulation (COATING Isolation Voltage Capability) (Dielectric must withstand indicated DC voltage for one minute per MIL-STD 202, Method 301)	5000	5000	5000	V
COATING Insulation Resistance	1000	1000	1000	M $\Omega$

**CAUTION:** Stresses above those listed in "Absolute Maximum Ratings" may cause permanent damage to the device. This is a stress only rating and operation of the device at these or any other conditions above those indicated in the operational sections of this specification is not implied.

### RA Series Ratings & Specifications

Part Number	Brand	Maximum Rating (125°C)				Specifications (25°C)					
		Continuous		Transient		Varistor Voltage at 1mA DC Test Current			Max Clamping Volt $V_C$ at 2.0A (8/20 $\mu$ s)		Typical Capacitance
		$V_{RMS}$	$V_{DC}$	Energy (10/1000 $\mu$ s)	Peak Current (8/20 $\mu$ s)						
		$V_{M(AC)}$	$V_{M(DC)}$	$W_{TM}$	$I_{TM}$	Min	$V_{N(DC)}$	Max	$V_C$	$I_D$	f = 1MHz
(mm)	(V)	(V)	(J)	(A)	(V)	(V)	(V)	(A)	(pF)		
<b>† RA8 Series</b>											
V8RA8	8R	4	5.5	0.4	150	6	8.2	11.2	22	5	3000
V12RA8	12R	6	8	0.6	150	9	12	16	34	5	2500
V18RA8	18R	10	14	0.8	250	14.4	18	21.6	42	5	2000
V22RA8	22R	14	18 (Note 3)	10 (Note 2)	250	18.7	22	26	47	5	1600
V27RA8	27R	17	22	1.0	250	23	27	31.1	57	5	1300
V33RA8	33R	20	26	1.2	250	29.5	33	36.5	68	5	1100
V39RA8	39R	25	31	1.5	250	35	39	43	79	5	900
V47RA8	47R	30	38	1.8	250	42	47	52	92	5	800
V56RA8	56R	35	45	2.3	250	50	56	62	107	5	700
V68RA8	68R	40	56	3.0	250	61	68	75	127	5	600
V82RA8	82R	50	66	4.0	1200	74	82	91	135	10	500
V100RA8	100R	60	81	5.0	1200	90	100	110	165	10	400
V120RA8	120R	75	102	6.0	1200	108	120	132	205	10	300
V150RA8	150R	95	127	8.0	1200	135	150	165	250	10	250
V180RA8	180R	115	153	10.0	1200	162	180	198	295	10	200
V200RA8	200R	130	175	11.0	1200	184	200	228	340	10	180
† V220RA8	220R	140	180	12.0	1200	198	220	242	360	10	160
† V240RA8	240R	150	200	13.0	1200	212	240	268	395	10	150
† V270RA8	270R	175	225	15.0	1200	247	270	303	455	10	130
† V360RA8	360R	230	300	20.0	1200	324	360	396	595	10	100
† V390RA8	390R	250	330	21.0	1200	354	390	429	650	10	90
† V430RA8	430R	275	369	23.0	1200	389	430	473	710	10	80
<b>† RA16 Series</b>											
V18RA16	18R16	10	14	3.5	1000	14.4	18	21.6	39	10	11000
V22RA16	22R16	14	18 (Note 3)	50 (Note 2)	1000	18.7	22	26	43	10	9000
V27RA16	27R16	17	22	5.0	1000	23	27	31.1	53	10	7000
V33RA16	33R16	20	26	6.0	1000	29.5	33	36.5	64	10	6000
V39RA16	39R16	25	31	7.2	1000	35	39	43	76	10	5000
V47RA16	47R16	30	38	8.8	1000	42	47	52	89	10	4500
V56RA16	56R16	35	45	10.0	1000	50	56	62	103	10	3900
V68RA16	68R16	40	56	13.0	1000	61	68	75	123	10	3300
V82RA16	82R16	50	66	15.0	4500	74	82	91	145	50	2500
V100RA16	100R16	60	81	20.0	4500	90	100	110	175	50	2000
V120RA16	120R16	75	102	22.0	4500	108	120	132	205	50	1700
V150RA16	150R16	95	127	30.0	4500	135	150	165	255	50	1400
V180RA16	180R16	115	153	35.0	4500	162	180	198	300	50	1100

### RA Series Ratings & Specifications

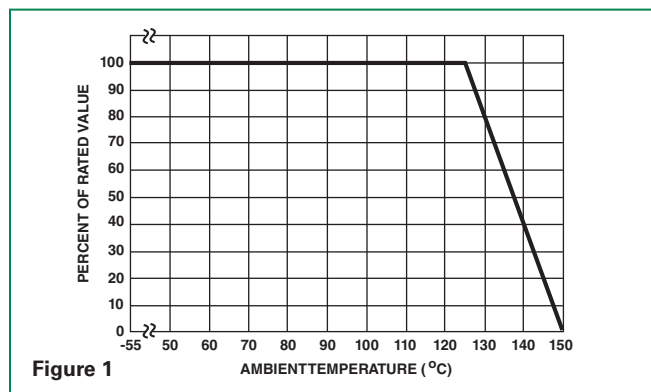
Part Number	Brand	Maximum Rating (125°C)				Specifications (25°C)					
		Continuous		Transient		Varistor Voltage at 1mA DC Test Current			Max Clamping Volt $V_C$ at 2.0A (8/20 $\mu$ s)		Typical Capacitance
		$V_{RMS}$	$V_{DC}$	Energy (10/1000 $\mu$ s)	Peak Current (8/20 $\mu$ s)						
		$V_{M(AC)}$	$V_{M(DC)}$	$W_{TM}$	$I_{TM}$	Min (V)	$V_{N(DC)}$ (V)	Max (V)	$V_C$ (V)	$I_p$ (A)	f = 1MHz (pF)
V200RA16	200R16	130	175	38.0	4500	184	200	228	340	50	1000
† V220RA16	220R16	140	180	42.0	4500	198	220	242	360	50	900
† V240RA16	240R16	150	200	45.0	4500	212	240	268	395	50	800
† V270RA16	270R16	175	225	55.0	4500	247	270	303	455	50	700
† V360RA16	360R16	230	300	70.0	4500	324	360	396	595	50	550
† V390RA16	390R16	250	330	72.0	4500	354	390	429	650	50	500
† V430RA16	430R16	275	369	75.0	4500	389	430	473	710	50	450

#### † RA22 Series

V24RA22	24R22	14	18 (Note 3)	100.0 (Note 2)	2000	19.2	24 (Note 4)	26	43	20	18000
V36RA22	36R22	23	31	160.0 (Note 2)	2000	32	36 (Note 4)	40	63	20	12000
† V200RA22	200R22	130	175	70.0	6500	184	200	228	340	100	1900
† V240RA22	240R22	150	200	80.0	6500	212	240	268	395	100	1600
† V270RA22	270R22	175	225	90.0	6500	247	270	303	455	100	1400
† V390RA22	390R22	250	330	130.0	6500	354	390	429	650	100	1000
† V430RA22	430R22	275	369	140.0	6500	389	430	473	710	100	900

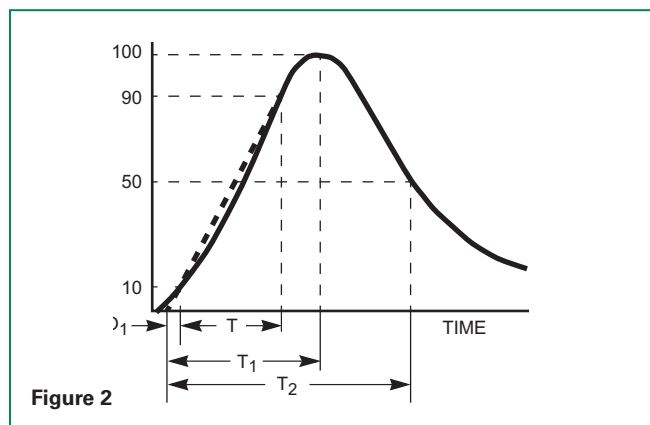
NOTES: 1. Average power dissipation of transients not to exceed 0.25W for RA8 Series, 0.60W for RA16 Series, or 1.0W for RA22 Series.  
 2. Energy ratings for impulse duration of 30ms minimum to one half of peak current value.  
 3. Also rated to withstand 24V for 5 minutes.  
 4. 10mA DC Test Current.  
 † Under UL File No. E320116 as a recognized component. CSA approved File No. LR91788.

### Power Dissipation Ratings



Should transients occur in rapid succession, the average power dissipation required is simply the energy (watt-seconds) per pulse times the number of pulses per second. The power so developed must be within the specifications shown on the Device Ratings and Specifications table for the specific device. Furthermore, the operating values need to be derated at high temperatures as shown above. Because varistors can only dissipate a relatively small amount of average power they are, therefore, not suitable for repetitive applications that involve substantial amounts of average power dissipation.

### Peak Pulse Current Test Waveform



$O_1$  = Virtual Origin of Wave  
 $T$  = Time from 10% to 90% of Peak  
 $T_1$  = Rise Time =  $1.25 \times T$   
 $T_2$  = Decay Time

**Example** - For an 8/20  $\mu$ s Current Waveform:

$8\mu s = T_1 = \text{Rise Time}$   
 $20\mu s = T_2 = \text{Decay Time}$

### Maximum Clamping Voltage for 8mm Parts

V8RA8 - V68RA8

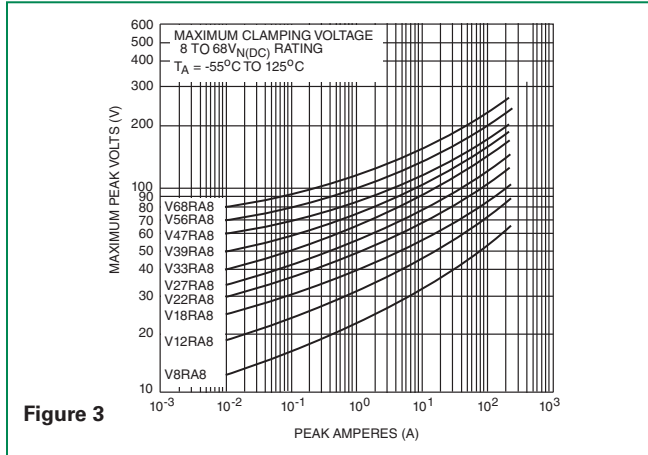


Figure 3

### Repetitive Surge Capability for 8mm Parts

V8RA8 - V12RA8

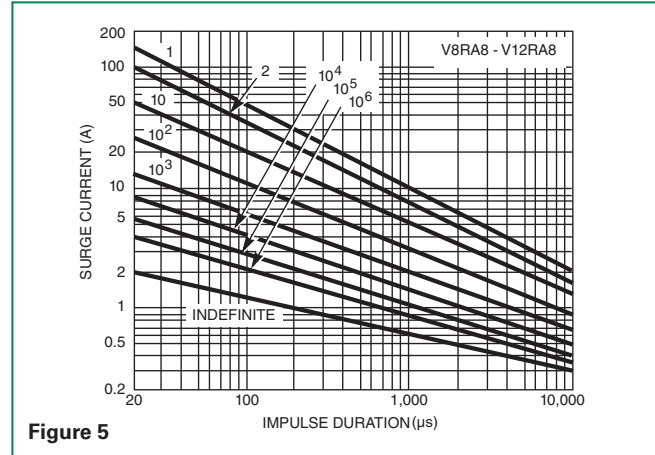


Figure 5

V82RA8 - V430RA8

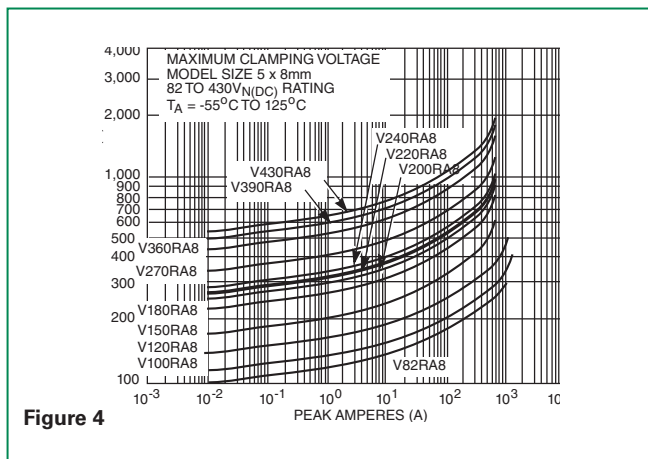


Figure 4

V18RA8 - V68RA8

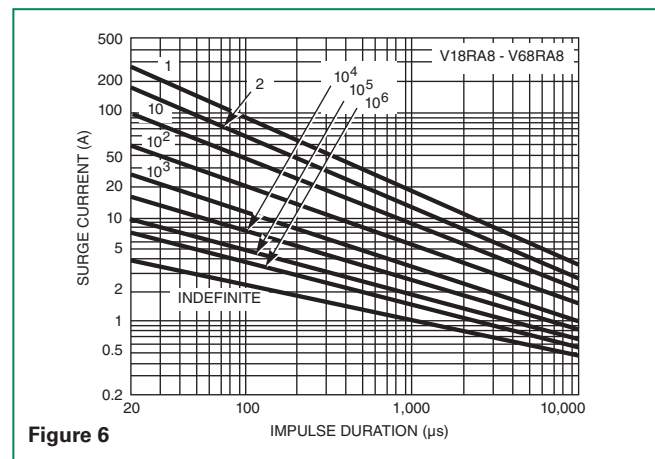


Figure 6

V82RA8 - V430RA8

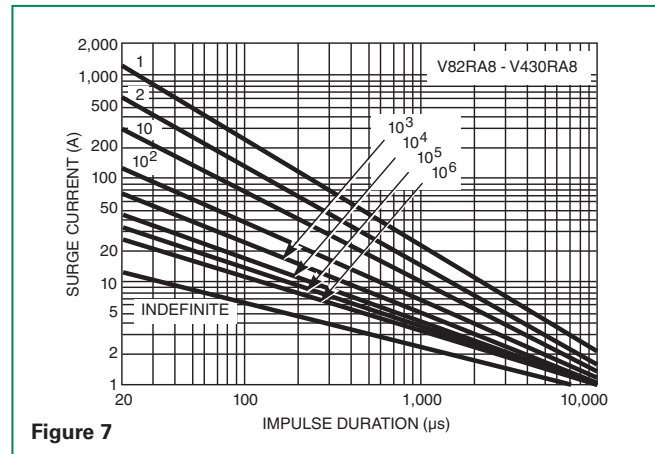
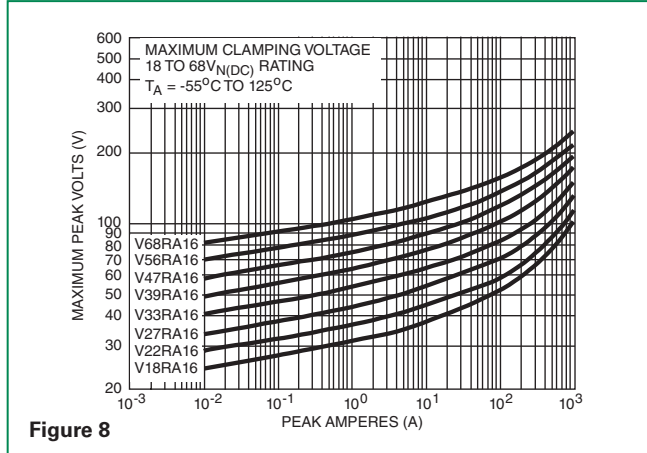


Figure 7



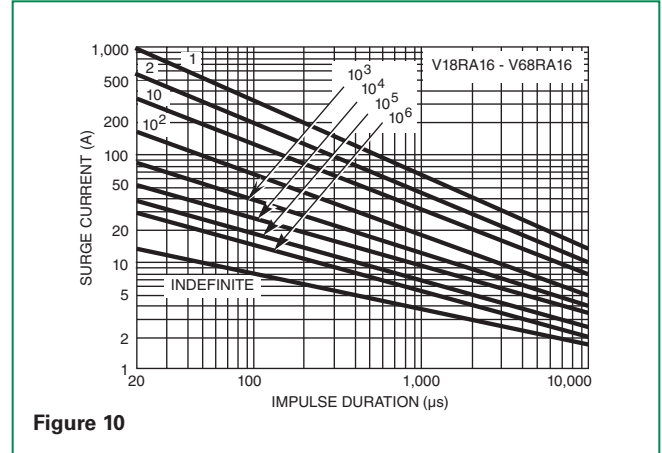
**Maximum Clamping Voltage for 16mm Parts**

V18RA16 - V68RA16

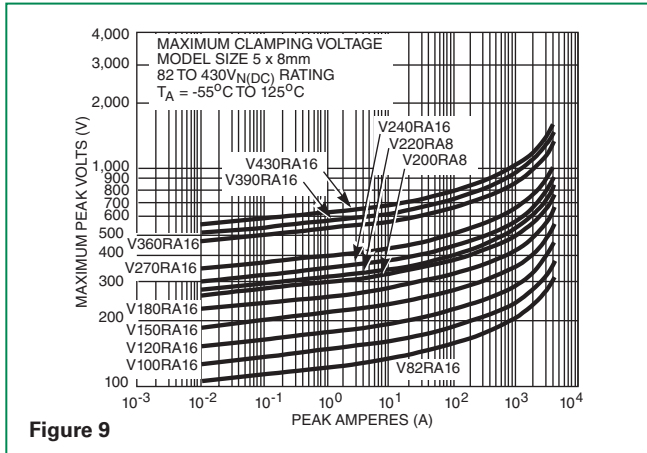


**Repetitive Surge Capability for 16mm Parts**

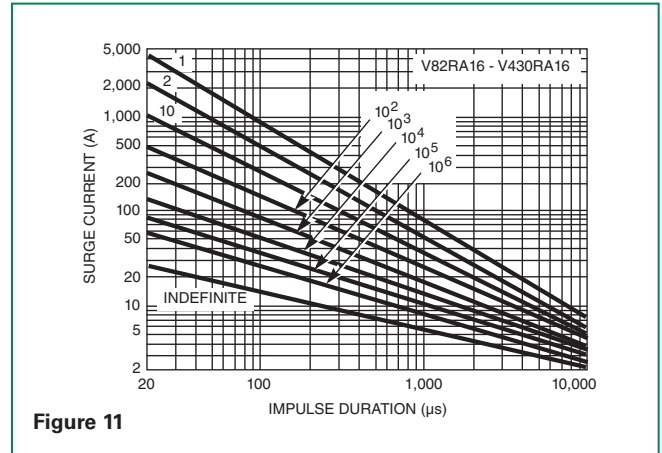
V18RA16 - V68RA16



V82RA16 - V430RA16



V82RA16 - V430RA16



### Maximum Clamping Voltage for 22mm Parts

V24RA22 - V36RA22

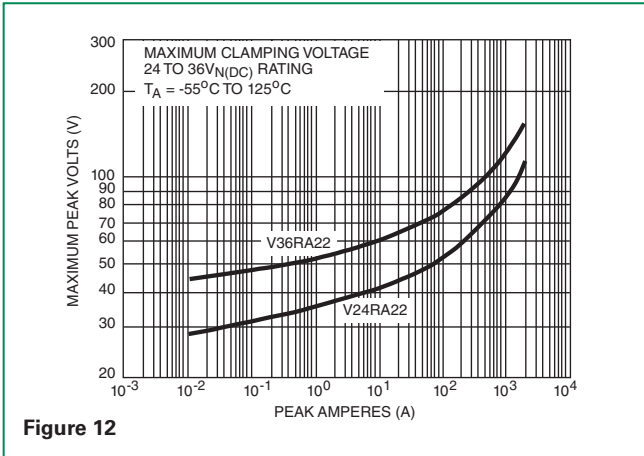


Figure 12

### Repetitive Surge Capability for 22mm Parts

V24RA22 - V36RA22

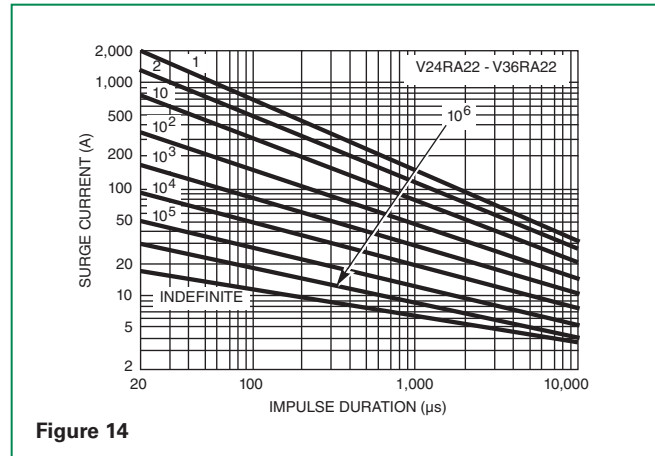


Figure 14

V200RA22 - V430RA22

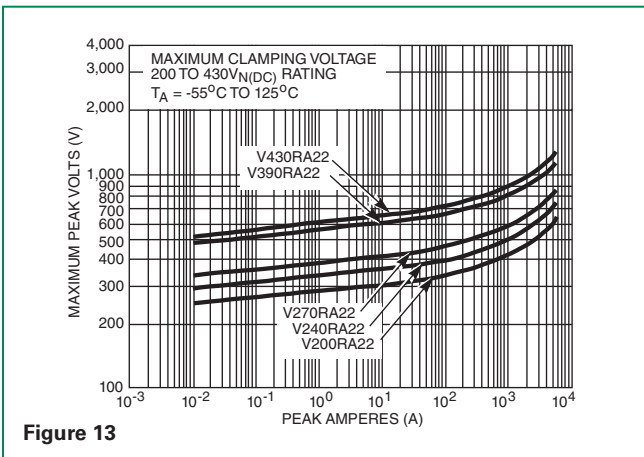


Figure 13

V200RA22 - V430RA22

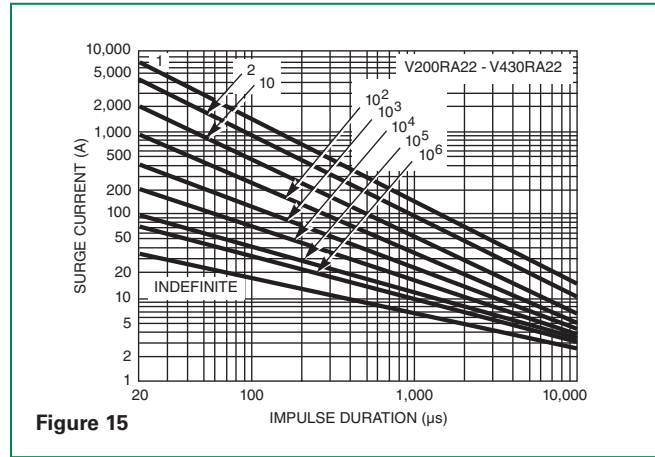


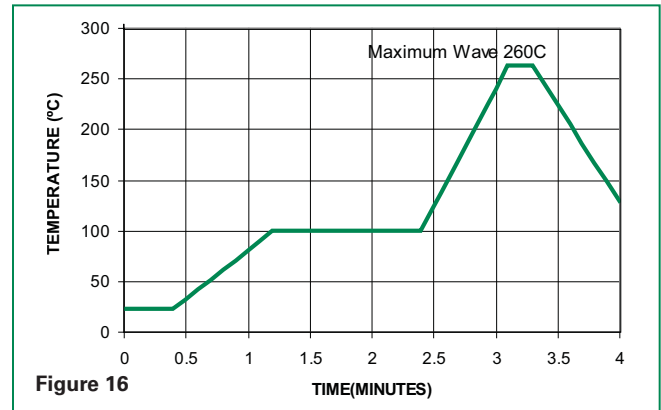
Figure 15

NOTE: If pulse ratings are exceeded, a shift of  $V_{N(DC)}$  (at specified current) of more than  $\pm 10\%$  could result. This type of shift, which normally results in a decrease of  $V_{N(DC)}$ , may result in the device not meeting the original published specifications, but it does not prevent the device from continuing to function, and to provide ample protection.

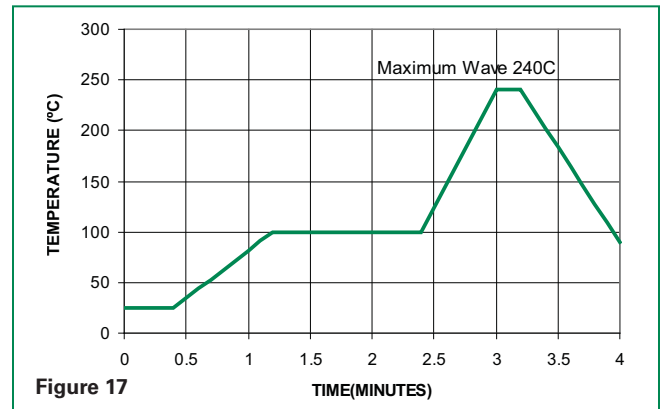
### Wave Solder Profile

Reflow Condition		Pb – Free assembly
Pre Heat	- Temperature Min (Ts(min))	150°C
	- Temperature Max (Ts(max))	200°C
	- Time (min to max) (ts)	60 – 180 secs
Average ramp-up rate (Liquidus Temp (TL) to peak)		5°C/second max
TS(max) to TL - Ramp-up Rate		5°C/second max
Reflow	- Temperature (TL) (Liquidus)	217°C
	- Temperature (tL)	60 – 150 seconds
Peak Temperature (TP)		250+0/-5°C
Time within 5°C of actual peak Temperature (tp)		20 – 40 seconds
Ramp-down Rate		5°C/second max
Time 25°C to peak Temperature (TP)		8 minutes Max.
Do not exceed		260°C

### Lead-free Profile



### Non Lead-free Profile



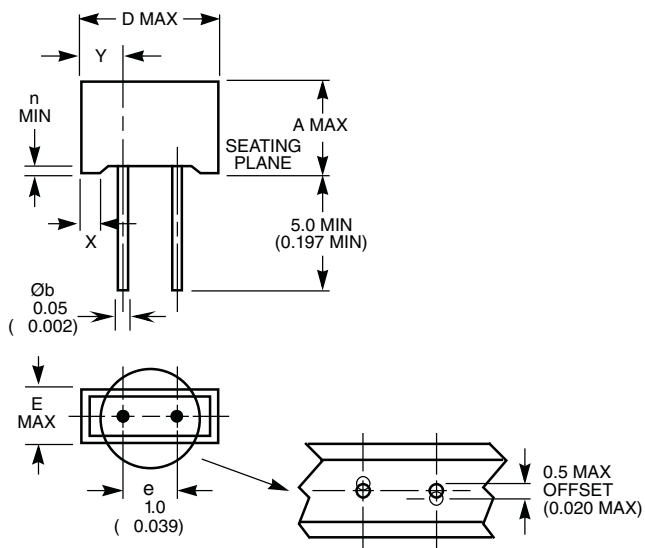
### Environmental Specifications

<b>Operating/Storage Temperature</b>	-55°C to +125°C / -55°C to +150°C
<b>Humidity Aging</b>	+85°C, 85% RH, 1000 hours +/-10% Voltage
<b>Thermal Shock</b>	+85°C to -40°C 10 times +/-10% Voltage
<b>Solvent Resistance</b>	MIL-STD-202, Method 215F
<b>Moisture Sensitivity</b>	Level 1, J-STD-020C

### Physical Specifications

<b>Lead Material</b>	Tin-Coated Copper
<b>Soldering Characteristics</b>	Solderability per MIL-STD-202, Method 208E
<b>Insulating Material</b>	Cured, flame retardant epoxy polymer meets UL94V-0 requirements.
<b>Device Labeling</b>	Marked with LF, voltage, amperage rating, and date code.

### Product Dimensions (mm)

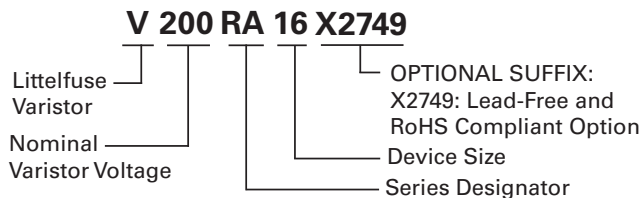


SYMBOL	RA8 Series	RA16 Series	RA22 Series
<b>A</b> (max.)	8.85 (0.348)	15.1 (0.594)	19.1 (0.752)
<b>D</b> (max.)	11.45 (0.450)	19.7 (0.776)	25.5 (1.004)
<b>e</b>	5 (0.197)	7.5 (0.295)	7.5 (0.295)
<b>E</b> (max.)	5.2 (0.205)	6.3 (0.248)	6.3 (0.248)
<b>n</b> (max.)	0.7 (0.027)	0.7 (0.027)	0.7 (0.027)
<b>Øb</b>	0.635 (0.025)	0.81 (0.032)	0.81 (0.032)
<b>Weight</b> (typical)	1 Gram	3.4 Grams	4.4 Grams
<b>X</b>	2.2 (0.087)	2.2 (0.087)	4.4 (0.173)
<b>Y</b>	3.1 +/- 0.5 (0.122 +/- 0.02)	6 +/- 1 (0.236 +/- 0.04)	8.9 +/- 1 (0.35 +/- 0.04)

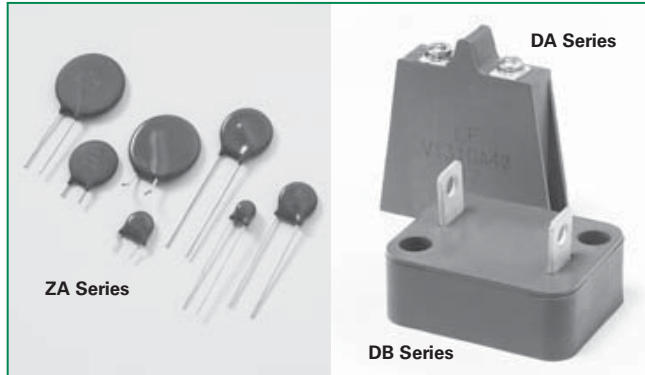
NOTES: Dimensions are in mm, with dimensions in inches in parentheses. Inches for reference only.

### Part Numbering System

The RA Series is supplied in bulk pack.



## High Reliability Varistors



### Description

Littelfuse High Reliability Varistors offer the latest in increased product performance, and are available for applications requiring quality and reliability assurance levels consistent with military or other standards (MIL-STD-19500, MIL-STD-750, Method 202). Additionally, Littelfuse Varistors are inherently radiation hardened compared to Silicon Diode suppressors as illustrated in Figure 1.

Littelfuse High-Reliability Varistors involve five categories:

- 1 DSSC Qualified Parts List (QPL) MIL-R-83530**  
(4 items presently available)
- 2 Littelfuse High Reliability Series TX Equivalents**  
(29 items presently available)
- 3 Custom Types**  
Processed to customer-specific requirements  
- (SCD) or to Standard Military Flow
- 4 Commercial Item Descriptors (CID) identified for Government use:**  
CID AA-55564-3 - Littelfuse ZA Series  
CID AA-55564-2 - Littelfuse DA, DB Series

### Agency Approvals

- DSSC Approved
- QPL Listed
- CECC Certified
- ISO Approved
- UL Recognized
- CSA Certified

### 1) DSSC Qualified Parts List (QPL) MIL-R-83530

This series of varistors are screened and conditioned in accordance with MIL-R-83530 as outlined in Table 2. Manufacturing system conforms to MIL-I-45208; MIL-Q-9858.

**Table 1. MIL-R-83530/1 Ratings and Characteristics**

Part Number M83530/	Nominal Varistor Voltage (V)	Tolerance (%)	Voltage Rating (V)		Energy Rating (J)	Clamping Voltage at 100A (V)	Capacitance at 1MHz (pF)	Clamping Voltage At Peak Current Rating (V)	I <sub>TM</sub> (A)	Nearest Commercial Equivalent
			(RMS)	(DC)						
1-2000B	200	-/+ 10	130	175	50	325	3800	570	6000	V130LA20B
1-2200D	220	+10, -5	150	200	55	360	3200	650	6000	V150LA20B
1-4300E	430	+5, -10	275	369	100	680	1800	1200	6000	V275LA40B
1-5100E	510	+5, -10	320	420	120	810	1500	1450	6000	V320LA40B

**Table 2. Mil-R-83530 Group A, B, and C Inspections**

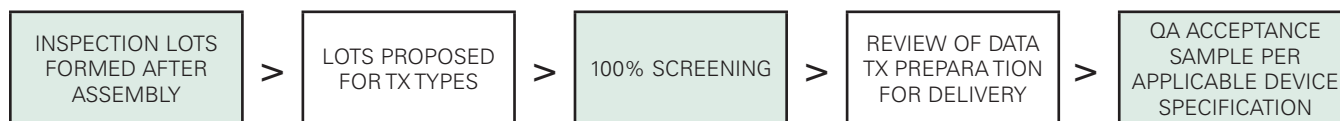
Inspection		AQL (Percent Defective)	Major	Minor	Number of Sample Units	Failures Allowed
Group A	SUBGROUP 1					
	High Temperature Life (Stabilization Bake)	100%	-	-	-	-
	Thermal Shock	100%	-	-	-	-
	Power Burn-In	100%	-	-	-	-
	Clamping Voltage	100%	-	-	-	-
	Nominal Varistor Voltage	100%	-	-	-	-
	SUBGROUP 2					
	Visual and Mechanical Examination	-	1.0% AQL 7.6% LQ	25% AQL 13.0% LQ	Per Plan	-
	Body Dimensions	-			Per Plan	-
	Diameter and Length of Leads	-			Per Plan	-
	Marking	-			Per Plan	-
	Workmanship	-			Per Plan	-
	SUBGROUP 3					
	Solderability	-	-	-	Per Plan	-
Group B	SUBGROUP 1					
	Dielectric Withstanding Voltage	-	-	-	Per Plan	-
	SUBGROUP 2					
	Resistance to Solvents	-	-	-	Per Plan	-
	SUBGROUP 3					
	Terminal Strength (Lead Fatigue)	-	-	-	Per Plan	-
	Moisture Resistance	-	-	-	Per Plan	-
	Peak Current	-	-	-	Per Plan	-
Energy	-	-	-	Per Plan	-	
Group C	EVERY 3 MONTHS					
	High Temperature Storage	-	-	-	10	0
	Operating Life (Steady State)	-	-	-	10	0
	Pulse Life	-	-	-	10	0
	Shock	-	-	-	10	0
	Vibration	-	-	-	10	0
	Constant Acceleration	-	-	-	10	0
	Energy	-	-	-	10	0

### 2) Littelfuse High Reliability Series TX Equivalents

**TABLE 5. Available TX Model Types**

TX Model	Model Size	Device Mark	(See Section 4) Nearest Commercial Equivalent	TX Model	Model Size	Device Mark	(See Section 4) Nearest Commercial Equivalent
V8ZTX1 V8ZTX2	7mm 10mm	8TX1 8TX2	V8ZA1 V8ZA2	V130LTX2 V130LTX10A V130LTX20B	7mm 14mm 20mm	130TX 130TX10 130TX20	V130LA2 V130LA10A V130LA20A
V12ZTX1 V12ZTX2	7mm 10mm	12TX1 12TX2	V12ZA1 V12ZA2	V150LTX2 V150LTX10A V150LTX20B	7mm 14mm 20mm	150TX 150TX10 150TX20	V150LA2 V150LA10A V150LA20B
V22ZTX1 V22ZTX3	7mm 14mm	22TX1 22TX3	V22ZA1 V22ZA3	V250LTX4 V250LTX20A V250LTX40B	7mm 14mm 20mm	250TX 250TX20 250TX40	V250LA4 V250LA20A V250LA40B
V24ZTX50	20mm	24TX50	V24ZA50	V420LTX20A V420LTX40B	14mm 20mm	420TX20 420TX40	V420LA20A V420LA40B
V33ZTX1 V33ZTX5 V33ZTX70	7mm 14mm 20mm	33TX1 33TX5 33TX70	V33ZA1 V33ZA5 V33ZA70	V480LTX40A V480LTX80B	14mm 20mm	480TX40 480TX80	V480LA40A V480LA80B
V68ZTX2 V68ZTX10	7mm 14mm	68TX2 68TX10	V68ZA2 V68ZA10	V510LTX40A V510LTX80B	14mm 20mm	510TX40 510TX80	V510LA40A V510LA80B

The TX Series of varistors are 100% screened and conditioned in accordance with MIL-STD-750. Tests are as outlined in Table 6.


**TABLE 6. TX Equivalents Series 100% Screening**

	MIL-STD-105		LTPD
	LEVEL	AQL	
Electrical (Bidirectional) $V_{NIDC}, V_C$ (Per Specifications Table)	II	0.1	-
Dielectric Withstand Voltage MIL-STD-202, Method 301, 2500V Min. at $1.0\mu A_{DC}$	-	-	15
Solderability MIL-STD-202, Method 208, No Aging, Non-Activated	-	-	15

**TABLE 7. Quality Assurance Acceptance Test**

Screen	MIL-STD-750 Method	Condition	TX Requirements
High Temperature Life (Stabilization Bake)	1032	24 hours min at max rated storage temperature.	100%
Thermal Shock (Temperature Cycling)	1051	No dwell is required at 25°C. Test condition A1, 5 cycles -55°C to +125°C (extremes) >10 minutes.	100%
Humidity Life		85°C, 85% RH, 168 Hrs.	100%
Interim Electrical $V_{NIDC}, V_C$ (Note 3)		As specified, but including delta parameter as a minimum.	100% Screen
Power Burn-In	1038	Condition B, 85°C, rated $V_{MIAC}$ , 72 hours min.	100%
Final Electrical $+V_{NIDC}, V_C$ (Note 3)		As specified - All parameter measurements must be completed within 96 hours after removal from burn-in conditions.	100% Screen
External Visual Examination	2071	To be performed after complete marking.	100%

### 3) Custom Types

In addition to our comprehensive high-reliability series, Littelfuse can screen and condition to specific requirements. Additional mechanical and environmental capabilities are defined in Table 8.

**TABLE 8. Mechanical And Environmental Capabilities (Typical Conditions)**

Test Name	Test Method	Description
Terminal Strength	MIL-STD-750-2036	3 Bends, 90° Arc, 16oz. Weight
Drop Shock	MIL-STD-750-2016	1500g's, 0.5ms, 5 Pulses, X <sub>1</sub> , V <sub>1</sub> , Z <sub>1</sub>
Variable Frequency Vibration	MIL-STD-750-2056	20g's, 100-2000Hz, X <sub>1</sub> , V <sub>1</sub> , Z <sub>1</sub>
Constant Acceleration	MIL-STD-750-2006	V <sub>2</sub> , 20,000g's Min
Salt Atmosphere	MIL-STD-750-1041	35°C, 24Hr, 10-50g/m <sup>2</sup> Day
Soldering Heat/Solderability	MIL-STD-750-2031/2026	260°C, 10s, 3 Cycles, Test Marking
Resistance to Solvents	MIL-STD-202-215	Permanence, 3 Solvents
Flammability	MIL-STD-202-111	15s Torching, 10s to Flameout
Flammability	UL1414	3 $\mu$ , 15s Torching
Cyclical Moisture Resistance	MIL-STD-202-106	10 Days
Steady-State Moisture Resistance	MIL-STD-750-1021.3	85/85 96Hr
Biased Moisture Resistance	MIL-STD-750-1021.3	Not Recommended for High-Voltage Types
Temperature Cycle	MIL-STD-202-107	-55°C to 125°C, 5 Cycles
High-Temperature Life (Nonoperating)	MIL-STD-750-1032	125°C, 24Hr
Burn-In	MIL-STD-750-1038	Rated Temperature and V <sub>RMS</sub>
Hermetic Seal	MIL-STD-750-1071	Condition D



### 4) Commercial Items

The General Services Administration has authorized the use of the Commercial Item Description (CID) for all government agencies. There are three (3) listed series within Littelfuse leaded/Industrial range:

- A-A-55564-3 (ZA Series)
- A-A-55564-2 (DA/DB Series)

The PIN number should be used to buy commercial product to the CID. The manufacturer's number shown should not be used for ordering purposes.

PIN consists of abbreviated CID number + Applicable Sheet (2 digits) + Dash number (-3 digits)

**Example:** AA55564 + 02 + -001 = AA5556402-001

**Table 9. ZA Series A-A-55564-3**

Dash Number AA5556403-	Equiv. Littelfuse Commercial Part	Dash Number AA5556403-	Equiv. Littelfuse Commercial Part	Dash Number AA5556403-	Equiv. Littelfuse Commercial Part	MFR's Cage
001	V22ZA05	022	V47ZA1	043	V120ZA4	S6019
002	V22ZA1	023	V47ZA3	044	V120ZA6	
003	V22ZA2	024	V47ZA7	045	V150ZA05	
004	V22ZA3	025	V56ZA05	046	V150ZA1	
005	V24ZA50	026	V56ZA2	047	V150ZA4	
006	V27ZA05	027	V56ZA3	048	V150ZA8	
007	V27ZA1	028	V56ZA8	049	V180ZA05	
008	V27ZA2	029	V68ZA05	050	V180ZA1	
009	V27ZA4	030	V68ZA2	051	V180ZA5	
010	V27ZA60	031	V68ZA3	052	V180ZA10	
011	V33ZA05	032	V68ZA10	053	V8ZA05	
012	V33ZA1	033	V82ZA05	054	V8ZA1	
013	V33ZA2	034	V82ZA2	055	V8ZA2	
014	V33ZA5	035	V82ZA4	056	V12ZA05	
015	V33ZA70	036	V82ZA12	057	V12ZA1	
016	V36ZA80	037	V100ZA05	058	V12ZA2	
017	V39ZA05	038	V100ZA3	059	V18ZA05	
018	V39ZA1	039	V100ZA4	060	V18ZA1	
019	V39ZA3	040	V100ZA15	061	V18ZA2	
020	V39ZA6	041	V120ZA05	062	V18ZA3	
021	V47ZA05	042	V120ZA1	063	V18ZA40	

**Table 10. DA/DB Series A-A-55564-2**

Dash Number AA5556402-	MFR's Cage	Equiv. Littelfuse Commercial Part	Dash Number AA5556402-	MFR's Cage	Equiv. Littelfuse Commercial Part
001	S6019	V131DA40	012	S6019	V131DB40
002		V151DA40	013		V151DB40
003		V251DA40	014		V251DB40
004		V271DA40	015		V271DB40
005		V321DA40	016		V321DB40
006		V421DA40	017		V421DB40
007		V481DA40	018		V481DB40
008		V511DA40	019		V511DB40
009		V571DA40	020		V571DB40
010		V661DA40	021		V661DB40
011		V751DA40	022		V751DB40

**High Reliability MOVs**

**Radiation Hardness**

For space applications, an extremely important property of a protection device is its response to imposed radiation effects.

**Electron Irradiation**

A Littelfuse MOV and a Silicon transient suppression diode were exposed to electron irradiation. The V-I curves, before and after test, are shown below.

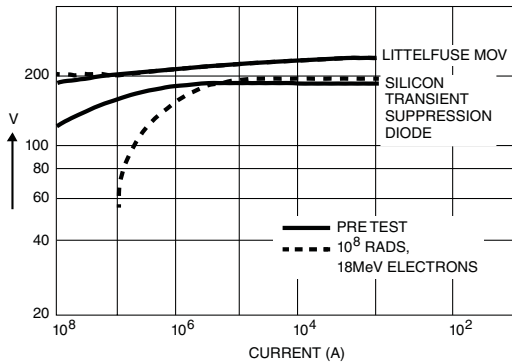


FIGURE 1. RADIATION SENSITIVITY OF LITTELFUSE V130LA1 AND SILICON TRANSIENT SUPPRESSION DIODE

It is apparent that the Littelfuse MOV was virtually unaffected, even at the extremely high dose of 108 rads, while the Silicon transient suppression diode showed a dramatic increase in leakage current.

**Neutron Effects**

A second MOV-Zener comparison was made in response to neutron fluence. The selected devices were equal in area.

Figure 2 shows the clamping voltage response of the MOV and the Zener to neutron irradiation to as high as 1015 N/cm<sup>2</sup>. It is apparent that in contrast to the large change in the Zener, the MOV is unaltered. At higher currents where the MOV's clamping voltage is again unchanged, the Zener device clamping voltage increases by as much as 36%.

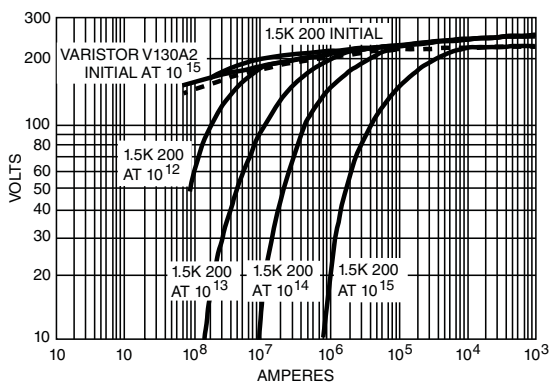


FIGURE 2. V-I CHARACTERISTIC RESPONSE TO NEUTRON IRRADIATION FOR MOV AND ZENER DIODE DEVICES

Counterclockwise rotation of the V-I characteristics is observed in Silicon devices at high neutron irradiation levels; in other words, increasing leakage at low current levels and increasing clamping voltage at higher current levels.

The solid and open circles for a given fluence represent the high and low breakdown currents for the sample of devices tested. Note that there is a marked decrease in current (or energy) handling capability with increased neutron fluence.

Failure threshold of Silicon semiconductor junctions is further reduced when high or rapidly increasing currents are applied. Junctions develop hot spots, which enlarge until a short occurs if current is not limited or quickly removed.

The characteristic voltage current relationship of a P-N Junction is shown below.

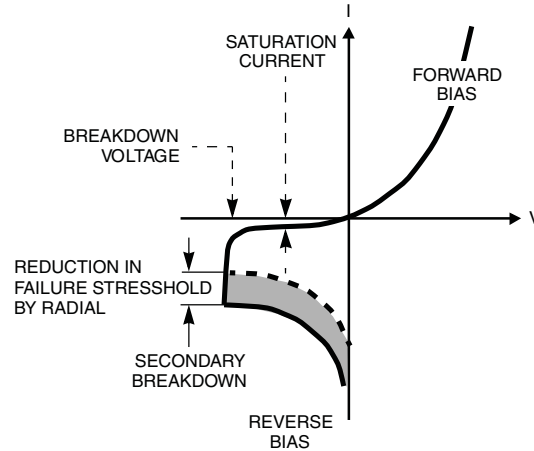


FIGURE 3. V-I CHARACTERISTIC OF PN-JUNCTION

At low reverse voltage, the device will conduct very little current (the saturation current). At higher reverse voltage VBO (breakdown voltage), the current increases rapidly as the electrons are either pulled by the electric field (Zener effect) or knocked out by other electrons (avalanching). A further increase in voltage causes the device to exhibit a negative resistance characteristic leading to secondary breakdown.

This manifests itself through the formation of hotspots, and irreversible damage occurs. This failure threshold decreases under neutron irradiation for Zeners, but not for Z<sub>N</sub>O Varistors.

**Gamma Radiation**

Radiation damage studies were performed on type V130LA2 varistors. Emission spectra and V-I characteristics were collected before and after irradiation with 106 rads Co60 gamma radiation. Both show no change, within experimental error, after irradiation.



Expertise Applied | Answers Delivered

Products

Design Support

Industries

Home

Products

Technology: Fuseholders and Accessories

Part Number: L60030C-1C

Technology: Fuseholders and Accessories

Series: L600C

600 Series - 600V Fuse Block for UL Class C2000  
Terminals for isolation. Class CC fuses and  
to assure proper fusing

WWW.LITTELFUSE.COM

To assist you with your electronics design and selection processes, Littelfuse also offers:

**Comprehensive Online Product Specs on Littelfuse.com**—Featuring easy-to-use navigation, search and selection tools, as well as additional product details. You can rely on Littelfuse.com for instant answers and continuously up-to-date information..

**Printed Product Catalogs**—For offline and off-the-shelf convenience, our printed product catalogs include data sheets, selection tables and tutorials covering all of our core technologies. Contact your Littelfuse product representative or visit [www.littelfuse.com/catalogs](http://www.littelfuse.com/catalogs) to check availability.

**Circuit Protection Design Guides**—Our application design center website, [www.littelfuse.com/designcenter](http://www.littelfuse.com/designcenter) offers a wealth of circuit protection guidance to help you select and apply the best circuit protection solution for your application.

As the world's #1 brand in circuit protection Littelfuse offers the broadest and deepest portfolio of circuit protection products and a global network of technical support, backed by more than 80 years of application design expertise. Visit our design support center to access:

- > Reference Designs
- > Application Notes
- > Application Testing
- > SPICE Models
- > Local Technical Support
- > Product Samples
- > Technical Articles
- > Certification Documents
- > Data Sheets



[WWW.LITTELFUSE.COM/DESIGNSUPPORT](http://WWW.LITTELFUSE.COM/DESIGNSUPPORT)

Littelfuse offers technologies that protect sensitive electronics and their users against electrostatic discharge (ESD), load switching, lightning strikes, overloads, short circuits, power cross, ground faults and other threats.

#### Overcurrent protection products:

**Fuses** Littelfuse offers the world's broadest range of fuse types and ratings, including cartridge, leaded, surface mount and thin film designs

**PTCs** Positive Temperature Coefficient thermistor technology provides resettable current-limiting protection

#### Overvoltage protection products:

**Varistors** Littelfuse offers surface mount Multi-Layer Varistors (MLVs) and industrial Metal Oxide Varistors (MOVs) to protect against transients

**GDTs** Gas Discharge Tubes (GDTs) to dissipate voltage through a contained plasma gas

**Thyristors** Littelfuse's solid state switches control the flow of current in a wide range of appliances, tools and equipment

**SIDACTor® Devices** Overvoltage protection specifically designed for telecom and datacom requirements

**TVS Diodes** Silicon transient voltage suppression (TVS) devices

**SPA™** Silicon Protection Arrays designed for analog and digital signal line protection

**PulseGuard® ESD Suppressors** Small, fast-acting Electrostatic Discharge (ESD) suppressors



To request catalogs for the Littelfuse portfolio of circuit protection technologies, please contact your authorized Littelfuse product representative or visit our website at [www.littelfuse.com/catalogs](http://www.littelfuse.com/catalogs)