

Bussmann®

D & DO LOW VOLTAGE FUSE SYSTEM



COOPER Bussmann

Bussmann®

CIRCUIT PROTECTION SOLUTIONS

Bussmann are one of the world's leading suppliers of fuses and fusible protection systems. Provider of the world's first truly global product line, each product is backed by an efficient world-wide distribution network service and unrivalled technical support. Bussmann circuit protection solutions comply with major international standards: BS, IEC, DIN and UL.

A comprehensive range of circuit protection solutions fused and non-fused.

D&D0 - 2004

Cooper Bussmann
Cooper (UK) Limited
Burton-on-the-Wolds
Leicestershire · LE12 5TH UK
Telephone: 44 (0) 1509 882 737
Facsimile : 44 (0) 1509 882 786
<http://www.bussmann.com>

© Cooper Bussmann 2004. Printed July 2004



NH FUSE SYSTEM



LOW VOLTAGE FUSE LINKS

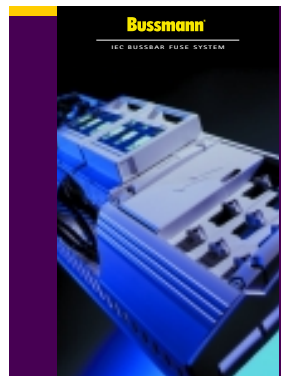

IEC BUSBAR FUSE SYSTEM



IEC CYLINDRICAL FUSE SYSTEM



HIGH SPEED FUSES



HIGH VOLTAGE PRODUCTS

Your Representative

A **COOPER** Industries Company.

Contents

Page

D0 Industrial Fuse links**1****D0 Fuse Bases & Accessories****2****D01 Fuse Switch Disconnectors & Accessories****4****D02 Fuse Switch Disconnectors & Accessories****6****D Type Industrial Fuse Links****8****D Type Fuse Bases & Accessories****10****D&D0 Semiconductor Protection Fuse Links****15****D&D0 Fuseology****17****D&D0 Cross Reference Table****19**

D0 FUSE LINKS

D0 fuse-links are used as the most reliable protection of electro installation, control and signal circuits against overload and short-circuit currents. The whole system D0 contains a complete range of fuse-links, standard ceramic and new plastic bases, fuse disconnectors and all necessary accessories. It is dimensioned for rated voltages 400 V a.c. resp. 250 V d.c. The system D0 is intended to be used in residential, business and similar buildings. When it is used in industrial plants, it is necessary to take into account the requirements of the standard IEC 60664-1 concerning the air insulation distances, creeping distances and mounting distances.

Advantages of D0 are the following:

- low power loss
- cooler running
- saving of storage and mounting place
- constant quality control of parts and final products

Technical data:

Rated voltage U_N	400V; 250V AC
Rated current I_N	DO1 2 - 16 A, DO2 20 - 63 A, DO3 80 - 100 A
Breaking capacity at 1, 1 U_N	50 kA $\cos\phi = 0,1$ 8 kA $\Rightarrow T = 15$ ms
Fusing characteristics Standards	gG - gL IEC 60269, EN 60269, DIN VDE 0636, DIN EN 60269-1 (VDE 0636 Teil 10), DIN EN 60269-3 (VDE 0636 Teil 30), DIN VDE 0636-301, IEC 60269-1.3 EN 60269-1.3 SIST EN 60269

Fuse-Links D01 gG (gL) for fuse base E 14

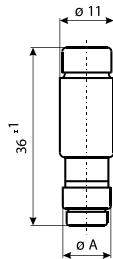

I_N (A)	colour	part No.	weight (g)	packaging (pcs)	dimension (ØA)
2	pink	2NZ01	6	10/500	7.3
4	brown	4NZ01	6	10/500	7.3
6	green	6NZ01	6	10/500	7.3
10	red	10NZ01	6	10/500	8.5
13	black	13NZ01	6	10/500	8.5
16	grey	16NZ01	6	10/500	9.7

Fuse-Links D02 gG (gL) for fuse base E 18

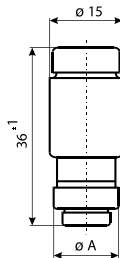

I_N (A)	colour	part No.	weight (g)	packaging (pcs)	dimension (ØA)
20	blue	20NZ02	11	10/500	10.9
25	yellow	25NZ02	12	10/500	12.1
32	black	32NZ02	13	10/500	13.3
35	white	35NZ02	13	10/500	13.3
40	black	40NZ02	13	10/500	13.3
50	white	50NZ02	13	10/500	14.5
63	copper	63NZ02	15	10/500	15.9

Fuse-Links D03 gG (gL) for fuse base M 30 x 2

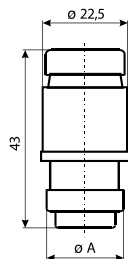

I_N (A)	colour	part No.	weight (g)	packaging (pcs)	dimension (ØA)
80	silver	80NZ03	35	10	21.4
100	red	100NZ03	35	10	21.4

D0 FUSE BASES

Application

The D0 fuse bases are designed for use in distribution boxes in domestic and public buildings. Total security against live parts is achieved by installing D0 fuse bases into the distribution boxes.

























Advantages

- modular construction-module 9 mm
- smaller weight and smaller height (66 mm) provide installation into the flush-mounting distribution boxes, the depth of which is 80 mm only
- by the aid of gauge-piece key it is possible to change the gauge rings
- the possibility of simple substitution of base D0 1 with D0 2.

Technical data:







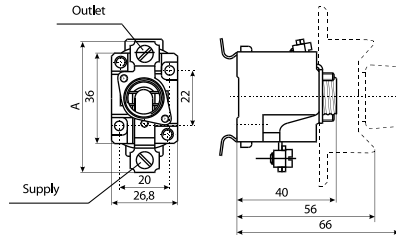

















Rated voltage U_N	400 V
Rated current I_N	D01 16 A, D02 63 A
Cross-section of connecting lead Standards	D01 1-4 mm ² D02 1,5-25 mm ² IEC 60269, EN 60269, DIN VDE 0636, SIST EN 60269

Single-pole fuse bases D0

type	part No.	$I_N(A)$	screw	with protection cover	without protection cover	click-on mounting	screw mounting	connections		cross-section of connecting lead (mm ²)	dimens. A (mm)	weight (g)	packaging (pcs)
								outlet	supply				
D01N - K	FRN01C	16	E14	x		X				1.5 - 4	53	68	15/300
D01V - K	FN01C	16	E14	x			X			1.5 - 4	53	66	15/300
D02N - K	FRN02C	63	E18	x		X				2.5 - 25	57	87	15/300
D02V - K	FN02C	63	E18	x			X			2.5 - 25	57	80	15/300
D02N M6 - K	FRN02C-A	63	E18	x		X				2.5 - 25	57	82	15/300
D02V M6 - K	FRN02C-SA	63	E18	x			X			2.5 - 25	57	80	15/300
D01N	FRN01-B	16	E14		x	X				1.5 - 4	53	56	15/300
D01V	FRN01-SB	16	E14		x		X			1.5 - 4	53	59	15/300
D02N	FRN02-D	63	E18		x	X				2.5 - 25	57	80	15/300
D02V	FRN02-SD	63	E18		x		X			2.5 - 25	57	77	15/300
D02N M6	FRN02-E	63	E18		x	X				2.5 - 25	57	75	15/300
D02V M6	FRN02-SE	63	E18		x		X			2.5 - 25	57	72	15/300



Three-pole fuse bases D0

type	part No.	$I_N(A)$	screw	with protection cover	without protection cover	click-on mounting	screw mounting	connections		cross-section of connecting lead supply	dimens. A (mm)	weight (g)	packaging (pcs)
								outlet	supply				
D01N/3 - K	TFRN01C	16	E14	x		X				1.5 - 4	53	216	5/100
D01V/3 - K	TFN01C	16	E14	x			X			1.5 - 4	53	187	5/100
D02N/3 - K	TFRN02C	63	E18	x		X				2.5 - 25	57	252	5/100
D02V/3 - K	TFN02C	63	E18	x			X			2.5 - 25	57	246	5/100
D02N/3 M6 - K	TFRN02C-A	63	E18	x		X				2.5 - 25	57	237	5/100
D02V/3 M6 - K	TFRN02C-SA	63	E18	x			X			2.5 - 25	57	231	5/100
D01N/3	TFRN01-B	16	E14		x	X				1.5 - 4	53	176	5/100
D01V/3	TFRN01-SB	16	E14		x		X			1.5 - 4	53	170	5/100
D02N/3	TFRN02-D	63	E18		x	X				2.5 - 25	57	235	5/100
D02V/3	TFRN02-SD	63	E18		x		X			2.5 - 25	57	229	5/100
D02N/3 M6	TFRN02-E	63	E18		x	X				2.5 - 25	57	220	5/100
D02V/3 M6	TFRN02-SE	63	E18		x		X			2.5 - 25	57	214	5/100

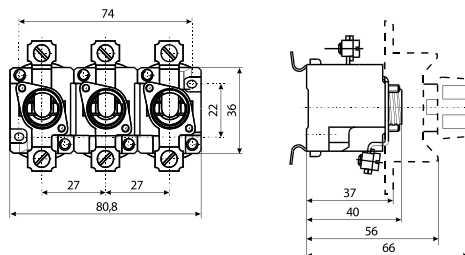

PROTECTION COVER FOR D0 FUSE BASES

D01, D02

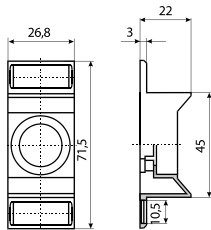
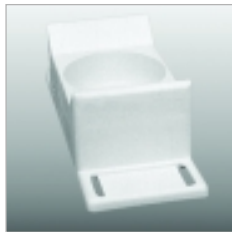

type	for fuse base	part No.	weight (g)	packaging (pcs)
D01	D01V, D01N	SFPCD01	8	50/700
D02	D02V, D02N	SFPCD02	8	50/700

D01/3, D02/3

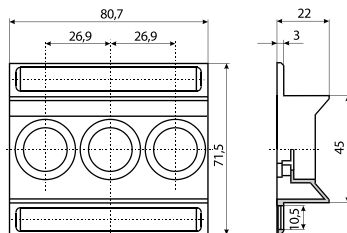
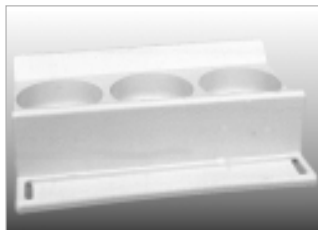

type	for fuse base	part No.	weight (g)	packaging (pcs)
D01/3	D01V/3, D01N/3	TFPCD01	17	14/280
D02/3	D02V/3, D02N/3	TFPCD02	16	14/280

PLASTIC BASE PPD01 AND PPD02

- 1: PPD01 for fuse links D01, 2 - 16A 400V a.c.
2: PPD02 for fuse links D02, 20 - 63A 400V a.c.

Standards

IEC 60269, EN 60269, DIN, VDE 0636

Application

They are mainly intended for distribution boxes in dwellings, office blocks and schools.

Total security against live parts is achieved by installing D0 fuse bases into the distribution boxes type DIDO.

Advantages

- Connection at the input is possible with a clamp or with a screw, at the output it is possible to connect with a clamp
- Mounting is on a standard DIN rail 35 mm (EN 50 022 and DIN EN 60715)
- Temperature resistant material
- Smaller weight of the product
- Layout is adjusted for modern built in devices.

Models: Single and three-pole version.

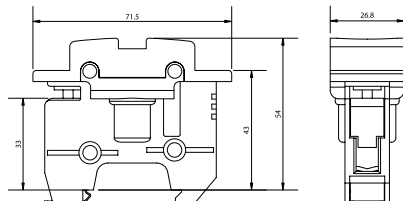

type	number of poles	I _N (A)	part No.	weight (g)	packaging (pcs)
PPD01-1	1	16	DD01-1	70	15
PPD01-3	3	16	DD01-3	220	3
PPD02-1	1	63	DD02-1	86	15
PPD02-3	3	63	DD02-3	270	3

GAUGE PIECES

V D01 for fuse base E 14

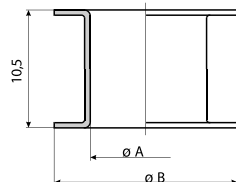

I _N (A)	part No.	colour	weight (g)	packaging (pcs)	dimension (ØA)	dimension (ØB)
2	2GN01	1001	pink	1 50/500	7.9	12
4	4GN01	1002	brown	1 50/500	7.9	12
6	6GN01	1003	green	1 50/500	7.9	12
10	10GN01	1004	red	1 50/500	9.1	12

V D02 for fuse base E 18

I_N (A)	part No.	colour	weight (g)	packaging (pcs)	dimension (ØA) (ØB)	
2*	2GN02	pink	1	50/500	7.9	16.6
4*	4GN02	brown	1	50/500	7.9	16.6
6*	6GN02	green	1	50/500	7.9	16.6
10*	10GN02	red	1	50/500	9.1	16.6
16*	16GN02	grey	1	50/500	10.3	16.6
20	20GN02	blue	1	50/500	11.5	16.6
25	25GN02	yellow	1	50/500	12.7	16.6
35	35GN02	black	1	50/500	13.9	16.6
50	50GN02	white	1	50/500	15.1	16.6

* for using fuse links D01 and fuse bases D02

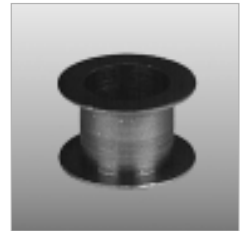
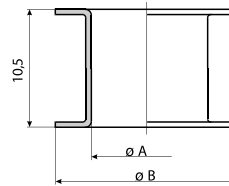

Fuse carriers D0

type	part No.	screw	weight (g)	packaging (pcs)
KN D01	CN01	E 14	14	20/500
KN D02	CN02	E 18	17	20/500

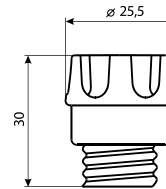

Special holder

part No.	weight (g)	packaging (pcs)
DO-SFH	1	25/300



Gauge piece key

part No.	weight (g)	packaging (pcs)
D0-GPK	17	20/120

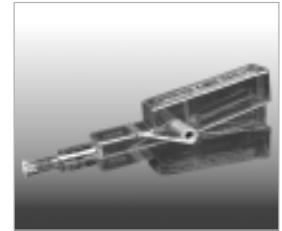

FUSE-SWITCH DISCONNECTOR VLD01

Fuse switch disconnecter is a protection device with an exchangeable holder. This system enables the following protecting advantages, concerning the DO fuse:

- Replacement of the fuse-link can be done with a mobile holder, without danger of direct contact to the live parts.
- The device can be switched on without screwing, contact pressure is applied automatically by a spring.
- Complete protection against touch by VBG 4.
- In position 1 and 0, the fuse-link operation indicator is visible through a transparent window.

Operating Principles of VLD01

Exchangeable holder for fuse-links D01 (2A to 6A, 10A, 16A) has also the function of a switch lever, to switch on and off the VLD01. The exchangeable holder can be replaced with an additional tool and it is used for mounting on the carrier rail according to EN 50 002 and DIN EN 60715 standards, in a way that the stopper is below.

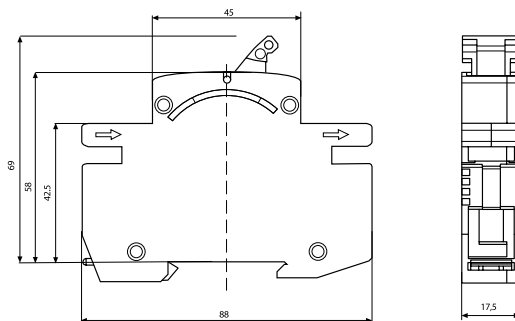

Technical data:

Rated voltage U_N	230V, 230/400V, 400V a.c.
Rated current I_N	2- 6A, 10A, 16A
Rated frequency f_N	45-62 Hz
Utilization category	AC22
Mechanical life	10.000 cycles
Electrical life	5.000 cycles
Poles	1p, 1p+N, 2p, 3p, 3p+N
Standards	VDE 0638, DIN 43880
Connection	25mm ²

VLD01 1P



I_N (A)	U_N (V)	part No.	weight (g)	packaging (pcs)
6	230/400	VLD01-1P6A	67	10/100
10	230/400	VLD01-1P10A	67	10/100
16	230/400	VLD01-1P16A	67	10/100

VLD01 1P+N



I_N (A)	U_N (V)	part No.	weight (g)	packaging (pcs)
6	230	VLD01-1PN6A	135	5/50
10	230	VLD01-1PN10A	135	5/50
16	230	VLD01-1PN16A	135	5/50

VLD01 2P



I_N (A)	U_N (V)	part No.	weight (g)	packaging (pcs)
6	400	VLD01-2P6A	135	5/50
10	400	VLD01-2P10A	135	5/50
16	400	VLD01-2P16A	135	5/50

VLD01 3P



I_N (A)	U_N (V)	part No.	weight (g)	packaging (pcs)
6	400	VLD01-3P6A	203	3/30
10	400	VLD01-3P10A	203	3/30
16	400	VLD01-3P16A	203	3/30

VLD01 3P+N



I_N (A)	U_N (V)	part No.	weight (g)	packaging (pcs)
6	400	VLD01-3PN6A	270	2/20
10	400	VLD01-3PN10A	270	2/20
16	400	VLD01-3PN16A	270	2/20

Accessories

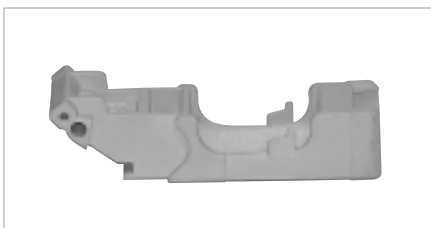

accessories	part No.	weight (g)	packaging (pcs)
holder/2-6A	D012-6A	6	15/600
holder/10A	D0110A	6	15/600
holder/16A	D0116A	6	15/600

SWITCH - DISCONNECTOR - FUSE STVD02

Switch disconnecter Fuse is a device which combines the functions of the switch and of the fuse D0. The system enables the following advantages of protection in comparison with the fuse D0:

- The changing of the fuse link without danger of direct touch of live parts.
- Snap-on mounting on rail according to VOK 50022 and DIN EN 60715.
- The complete protection against touch according to VBG 4.
- The possibility of connecting supply from the upper or from the lower side.
- It can be used as a main switch and tariff fuse in a single device.
- Possibility of sealing in ON or OFF positions with or without fuse-link.

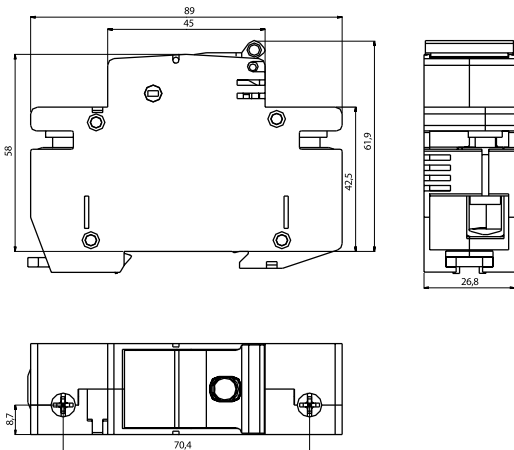

Technical data:

Standards	VDE 0638 EN 60 947-3, DIN VDE 0113, DIN VDE 0110
Number of poles	1p, 1p+N, 2p, 3p, 3p+N
Rated voltage	230/400V a.c., 110V (2p) d.c.
Rated breaking capacity	50 kA
Rated insulation voltage	400V
Rated impulse resistance voltage	8000V
Category of use according to DIN VDE 0638	AC 22(63A), AC 23(35A), DC 22 (63A)
Category of use according to DIN E 60 947-3	
Mechanical life	5,000 cycles
Electrical life	300 cycles
Temperature of environment	-5 C to +40 C
Air humidity	90%
Degree of protection	IP 00 according to / nach DIN 40 050
Connection clamps	Up to 35mm 2 (multiwire conductor) with screw +/-
Possibility of sealing	in ON or OFF position

STVD02

type	number of poles	I _N (A)	part No.	weight (g)	packaging (pcs)
STV D02-1	1	63	STV-D02-1P	119	12
STV D02-1N	1+N	63	STV-D02-1PN	238	6
STV D02-2	2	63	STV-D02-2P	238	6
STV D02-3	3	63	STV-D02-3P	357	4
STV D02-3N	3+N	63	STV-D02-3PN	476	3



SWITCH DISCONNECTOR FUSE STVD02 ACCESSORIES

Gauge pieces

I _N (A)	part No.	weight (g)	packaging (pcs)
20	STVGP-DO2-20	0.8	50
25	STVGP-DO2-25	0.6	50
35	STVGP-DO2-35	0.5	50
50	STVGP-DO2-50	0.4	50

Their function is to limit the use of D0 fuse-links to user prescribed rated currents. The gauge piece can be inserted into the holder, when the fuse holder is extracted from the housing.



Adapter

part No.	weight (g)	packaging (pcs)
STV-ADP	2.5	20

Its function is to allow the use of D01 fuse links (2-16A) with the fuse switch disconnecter STV D02.



AUXILIARY SWITCH STV

Auxiliary switch STV is intended to be mounted with switches of series STV. The width of apparatus is 9mm, other dimensions comply with STV series switches. Auxiliary switch STV serves for distant signalization of the state of contacts (on/off) of STV switch for circuit control.



type	contacts	weight (g)	part No.
PS STV - MD	1 x b contacts, 1 x a contacts	50	STV-ADP-MD
PS STV - 2M	2 x b contacts	50	STV-ADP-2M
PS STV - 2D	2 x a contacts	50	STV-ADP-2D

a... make contact
b... break contact

Technical data:

Rated current I_N	AC12 6A at 230V ~ DC12 1A at 110V =
Rated conditional short circuit current	1kA at 20A fuse link
Standards	EN 62019

D FUSE LINKS

D type fuse-links are used to protect electric, signal and control I/t characteristics of type fuse-links comply with the following standards: IEC 60269/1, DIN VDE 0636/301 and CEE 16.

CEE 16 standard regulates two types of characteristics:

- quick characteristics, in ETI the so-called DZ and
- time-lag, in ETI the so-called TDZ.

VDE 0603/301 and IEC 60269-1 regulates the gG characteristics (protection in the whole range of the breaking capacity of the fuse). Because their breaking characteristics are completely in accordance with CEE 16 requirements for slow characteristics, they can also be labeled as TDZ.

Technical data:

Rated voltage U_N	500 V
Rated current I_N	DI, DII 2 do 25 A, DIII 32 do 63 A DIV 80 do 100 A, DV 125 do 200 A
Breaking capacity at 1, $1U_N$	50 kA ~ $\cos\phi = 0,2$ 8kA $\approx T = 15ms$
Fusing characteristics	gL - gG, TDZ, DZ
Insulating class	C - VDE 0110
Standards	DIN EN 60269-1 (VDE 0636 Teil 10) DIN EN 60269-3 (VDE 0636 Teil 30) DIN VDE 0636-301 IEC 60269-1 IEC 60269-3 EN 60269-1 EN 60269-3 CEE 16

DI for fuse base E 16

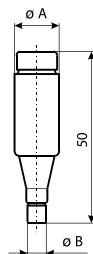

$I_N(A)$	colour	part No. DZ	code No. gG, gL, TDZ	weight (g)	packaging (pcs)	dimension ØA	ØB
2	pink	2D16Q	2D16	12	20/500	13.2	6
4	brown	4D16Q	4D16	12	20/500	13.2	6
6	green	6D16Q	6D16	12	20/500	13.2	6
10	red	10D16Q	10D16	13	20/500	13.2	8
16	grey	16D16Q	16D16	14	20/500	13.2	10
20	blue	20D16Q	20D16	15	20/500	13.2	12
25	yellow	25D16Q	25D16	16	20/500	13.2	14

DII for fuse base E 27

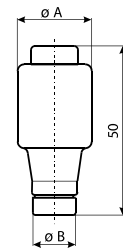

$I_N(A)$	colour	part No. DZ	code No. gG, gL, TDZ	weight (g)	packaging (pcs)	dimension ØA	ØB
2	pink	2D27Q	2D27	27	5/500	21.5	6
4	brown	4D27Q	4D27	27	5/500	21.5	6
6	green	6D27Q	6D27	27	5/500	21.5	6
10	red	10D27Q	10D27	27	5/500	21.5	8
13	black		13D27	27	5/500	21.5	8
16	grey	16D27Q	16D27	28	5/500	21.5	10
20	blue	20D27Q	20D27	29	5/500	21.5	12
25	yellow	25D27Q	25D27	30	5/500	21.5	14

DIII for fuse base E 33

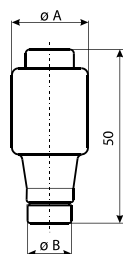

$I_N(A)$	colour	part No. DZ	code No. gG, gL, TDZ	weight (g)	packaging (pcs)	dimension ØA	ØB
32	black		32D33	48	5/500	27	16
35	black	35D33Q	35D33	48	5/500	27	16
40	black		40D33	48	5/500	27	16
50	white	50D33Q	50D33	49	5/500	27	18
63	copper	63D33Q	63D33	52	5/500	27	20

DIV for fuse base R1 1/4"

$I_N(A)$	colour	part No. DZ	code No. gG, gL, TDZ	weight (g)	packaging (pcs)	dimension ØA ØB	
80	silver	80D125Q	80D125	105	10/100	33	5
100	red	100D125Q	100D125	110	10/100	33	7

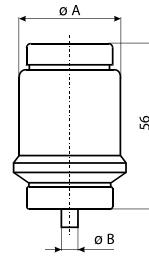

DV for fuse base R 2"

$I_N(A)$	colour	part No. DZ	code No. gG, gL, TDZ	weight (g)	packaging (pcs)	dimension ØA ØB	
125	yellow	125D200Q*	125D200*	185	10/60	46	5
160	copper	160D200Q*	160D200*	210	10/60	46	7
200	blue	200D200Q*	200D200*	215	10/60	46	9

* special order



GAUGE PIECES

VD II for fuse base E 27

$I_N(A)$	colour	part No.	weight (g)	packaging (pcs)	dimension			
					A	B	C	D
2	pink	2GD27	13	25/1500	3/16"	6.5	17	24
4	brown	4GD27	13	25/1500	3/16"	6.5	17	24
6	green	6GD27	13	25/1500	3/16"	6.5	17	24
10	red	10GD27	11	25/1500	3/16"	8.5	17	24
16	grey	16GD27	11	25/1500	3/16"	10.5	17	24
20	blue	20GD27	11	25/1500	3/16"	12.5	17	24
25	yellow	25GD27	11	25/1500	3/16"	14.5	17	24

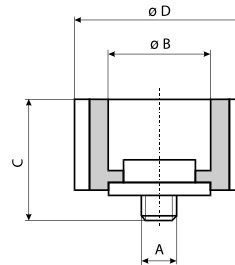

VD III for fuse base E33

$I_N(A)$	colour	part No.	weight (g)	packaging (pcs)	dimension			
					A	B	C	D
35	black	35GD33	19	25/850	3/16"	16.5	17	30
50	white	50GD33	18	25/850	3/16"	18.5	17	30
63	copper	63GD33	16	25/850	3/16"	20.5	17	30

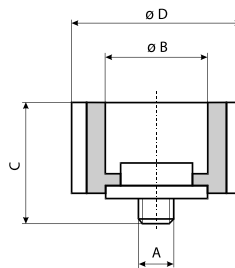

D TYPE FUSE BASES

Application

The fuse bases type D are made to be incorporated into distribution boxes for individual applications, in industrial and public buildings. The bases most up-to-date design are EZN for mounting on rails (according to EN 50022 and DIN EN 60715) and bases EZR type, because they can be directly fastened on the EZR-busbar.

Technical data:

Rated voltage U_N	500 V
Rated current I_N	DII 25 A, DIII 63 A
Insulating class	po VDE 0110 C
Cross-section of connecting lead	DII 1 to 10 mm ² DIII 2,5 to 25 mm ²
Standards, publications	IEC 60269, EN 60269, DIN VDE 0636

SINGLE-POLE FUSE BASES

EZ

HVB

type	I_N (A)	part No.	screw	weight (g)	packaging (pcs)	dimension						
						A	B	C	D	E	F	G
EZ	25	SFD27	E 27	122	36/288	41	47	36	20	35	13	46
EZ	63	SFD33	E 33	175	15/180	45	56	45	20	36	14	58

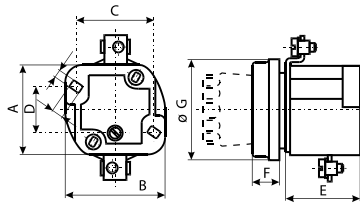

TZ

type	I_N (A)	part No.	screw	weight (g)	packaging (pcs)	dimension						
						A	B	C	D	E	F	G
TZ	25	SFD27-TZ	E 27	185	24/192	26	50	53	13.5	14	M	46
TZ	63	SFD33-TZ	E 33	368	10/100	31	58	64	16	18	M	58

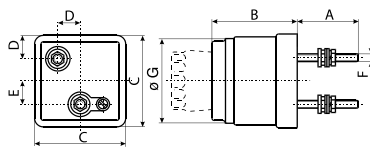

UZ, UZN

type	I_N (A)	part No.	screw	weight (g)	packaging (pcs)	dimension							
						A	B	C	D	E	F	G	I
UZ	25	SFD27-UZ	E 27	200	10/200	56	80	41	33	82	20	4.5	4.5
UZN	25	SFD27-UZN	E 27	202	10/180	56	80	41	33	82	20	4.5	4.5
UZ	63	SFD33-UZ	E 33	300	6/60	56	90	52	41	82	28	4.5	4.5
UZN	63	SFD33-UZN	E 33	302	6/60	56	90	52	41	82	28	4.5	4.5

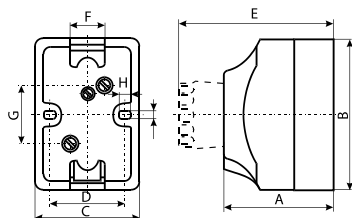
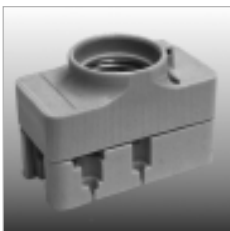

- * UZ - For mounting with screws
- * UZN - For mounting on rail

Protection cover for fuse bases EZN and EZV

type	I _N (A)	part No.	screw	weight (g)	packaging (pcs)	dimension			
						A	B	C	D
EZN, EZV	25	SFPRD27	E 27	16	30/390	40	24	10.8	80
EZN, EZV	63	SFPRD33	E 33	12	30/360	49	21	9	80

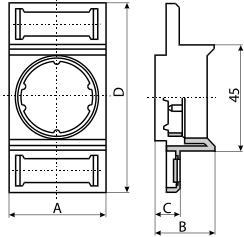

D Comfort

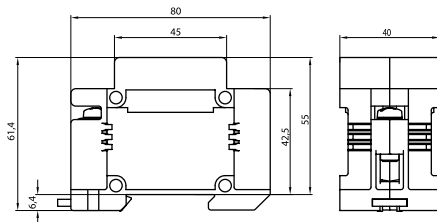

type	part No.	weight (g)	packaging (pcs)
DII comfort	SFD27-CFT	137	3/105

Technical data:

Rated voltage U _N	500V
Rated current I _N	25 A
For fuse-links type DII	acc. to IEC/EN 60269-3
Gauge pieces VDII	acc. to IEC/EN 60269-3
Cross section of connecting leads	1.5 - 25 mm ²
Screws	with ±head
Mounting possibilities:	- with screws - mounting on the rail EN 50022 and EN60715

D TYPE THREE-POLE FUSE BASES

EZN/3, EZV/3 - Delta

type	I _N (A)	part No.	weight (g)	packaging (pcs)	dimension							
					A	B	C	D	E	F	G	H
EZN 25/3	25	TFD27-EZN	410	8	106	106	48	/	/	45	52	86
EZV 25/3	25	TFD27-EZV	400	8	106	106	48	32	5.2	45	52	86
EZN 63/3	63	TFD33-EZN	590	8	127	130	54	/	/	45	52	85
EZV 63/3	63	TFD33-EZV	580	8	127	130	54	32	5.2	45	52	85

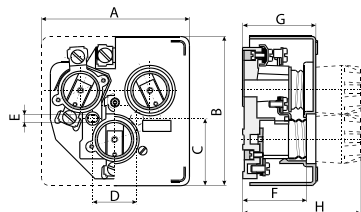

EZN/3, EZV/3 - Linear

type	I _N (A)	part No.	screw	weight	packaging (pcs)	dimension							
						A	B	C	D	E	F	ØG	H
EZN 25/3	25	TFRD27	E27	352	4/60	41	121	44	47	60	30	4.3	50
EZV 25/3	25	TFD27	E27	346	4/60	41	121	44	47	60	30	4.3	50
EZN 63/3	63	TFRD33	E33	488	6/42	43	148	44	47	56	32	4.3	62
EZV 63/3	63	TFD33	E33	484	6/42	43	148	44	47	56	32	4.3	62

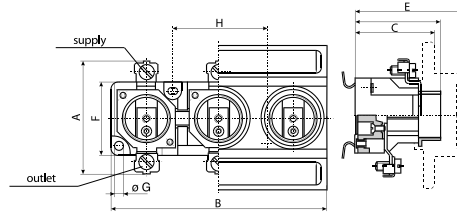

Protection cover for fuse bases EZN/3 and EZV/3

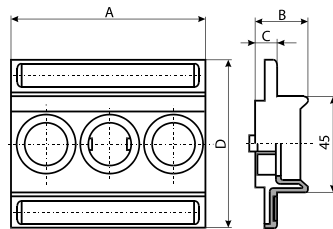
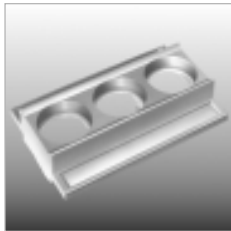

type	part No.	weight (g)	packaging (pcs)	dimension			
				A	B	C	D
EZN, EZV 25/3	TFPCD27	40	12/120	121	24	10.8	80
EZN, EZV 63/3	TFPCD33	40	12/120	148	21	9	80

Fuse Carriers

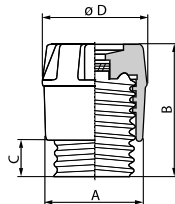

type	I _N (A)	part No.	screw	weight (g)	packaging (pcs)	dimension			
						A	B	C	D
K DII	25	CD27	E27	35	50/600	E	44	12	34
K DIII	63	CD33	E33	59	30/360	E	44	12	43

Fuse bases for Overhead Lines

type	I _N (A)	part No.	weight (g)	packaging (pcs)	dimension							
					ØA	B	ØC	D	E	F	ØG	H
FZ	25	SFD27-OHL	750	1/22	61	14	104	118	90	50	7	20
FZ	63	SFD33-OHL	1050	1/16	70	21	114	120	130	58	7	21

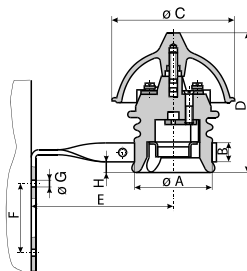

Amoured Fuse Bases

type	part No.	weight (g)	packaging (pcs)	dimension								
				A	B	C	D	E	F	G	H	I
T 25/3N	SFD27-ARM3N	460	4	106	106	48	/	/	45	52	86	97
T 63/3N	SFD33-ARM3N	660	4	127	130	54	/	/	45	52	85	97
T 25/3V	SFD27-ARM3V	450	4	106	106	48	32	5.2	45	52	86	97
T 63/3V	SFD33-ARM3V	650	4	127	130	54	32	5.2	45	52	85	97

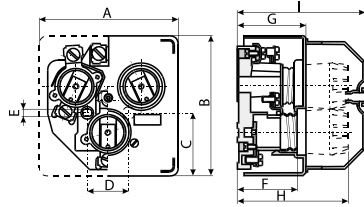
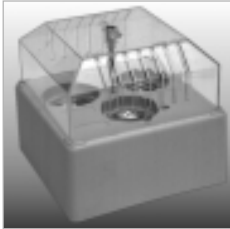

Fuse-link D 01 ULTRA-QUICK® for base E14

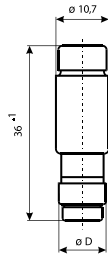

I_N (A)	part No.	colour	weight (g)	packaging (pcs)	dimension ØD
2	2NZ01R	pink	6	10/500	7.3
4	4NZ01R	brown	6	10/500	7.3
6	6NZ01R	green	6	10/500	7.3
10	10NZ01R	red	6	10/500	8.5
16	16NZ01R	grey	6	10/500	9.7

Fuse-link D 02 ULTRA-QUICK® for base E18

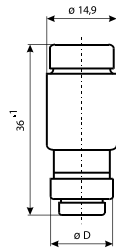

I_N (A)	part No.	colour	weight (g)	packaging (pcs)	dimension ØD
20	20NZ02R	blue	11	10/500	10.9
25	25NZ02R	brown	12	10/500	12.1
35	35NZ02R	black	13	10/500	13.3
50	50NZ02R	white	13	10/500	14.5
63	63NZ02R	copper	15	10/500	15.9

Technical data:

Fuse-link	D 01 / D 02 ULTRA QUICK
Rated voltage U_N	400 V ~ / 250 V
Rated current I_N	2 - 63 A
Breaking Capacity I1	50 kA ~ / 8 kA
Fusing characteristic	gR

$I^2 \times t$ values D0 ULTRA-QUICK®

Rated current (A)	Melting integral (A ² ·s)	Total integral (A ² ·s)		
		at 100 V	at 200 V	at 400 V
2	1	2.3	4	6.3
4	2	4.7	8	13
6	5	7	12	20
10	12	25	40	65
16	35	70	100	200
20	55	120	180	275
25	85	160	280	480
35	180	250	450	1000
50	250	550	850	1800
63	550	800	1200	2500

Fuse-link D I ULTRA-QUICK® for base E16

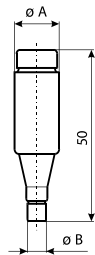

I_N (A)	part No.	colour	weight (g)	packaging (pcs)	dimension ØB
2	2D16R	pink	12	20/500	6
4	4D16R	brown	12	20/500	6
6	6D16R	green	12	20/500	6
10	10D16R	red	13	20/500	8
16	16D16R	grey	14	20/500	10
20	20D16R	blue	15	20/500	12
25	25D16R	yellow	16	20/500	14

Fuse-link D II ULTRA-QUICK® for base E27

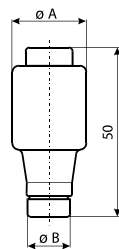

I_N (A)	part No.	colour	weight (g)	packaging (pcs)	dimension ØB
2	2D27R	pink	27	5/500	6
4	4D27R	brown	27	5/500	6
6	6D27R	green	27	5/500	6
10	10D27R	red	27	5/500	8
16	16D27R	grey	28	5/500	10
20	20D27R	blue	29	5/500	12
25	25D27R	yellow	30	5/500	14
30	30D27R	black	30	5/500	14

Fuse-link D III ULTRA-QUICK® for base E33

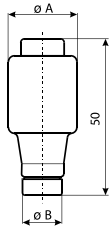

I_N (A)	part No.	colour	weight (g)	packaging (pcs)	dimension ØB
35	35D33R	black	48	5/500	16
50	50D33R	white	49	5/500	18
63	63D33R	copper	52	5/500	20

Fuse-link D IV ULTRA-QUICK® for base R1 1/4"

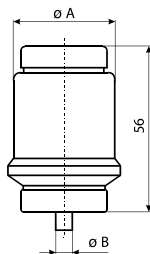

I_N (A)	part No.	colour	weight (g)	packaging (pcs)	dimension ØB
80	80D125R	silver	105	10/100	5
100	100D125R	red	110	10/100	7

Fuse-link D V ULTRA-QUICK® for base R 2"

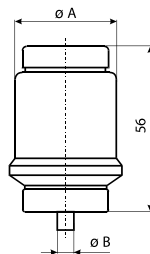

I_N (A)	part No.	colour	weight (g)	packaging (pcs)	dimension ØB
125	125D200R	yellow	185	10/60	5
160	160D200R	copper	210	10/60	7
200	200D200R	blue	215	10/60	9

I²t values D ULTRA-QUICK®

Rated current (A)	Melting integral (A²·s)	Max Total integral (A²·s)		
		at 125 V	at 250 V	at 500 V
2	0.7	1.8	3.5	5.8
4	1.8	4.1	6	11
6	4	6	10	18
10	8	12.5	23	40
16	16.2	34	40	60
20	35.8	67	85	139
25	48.9	85	116	205
30	85	120	170	310
35	135	220	300	539
50	340	600	780	1250
63	530	850	1115	1890
80	980	1480	2110	4200
100	1950	3000	4200	8450
125	3100	4300	6000	16000
160	10000	12000	18000	24000
200	17000	22000	31000	40000

Technical data:

Fuse-link DI, D II, D III, D IV, D V, ULTRA QUICK®
Rated voltage U_N 500 V ~ / 315 V ==
Rated current I_N 2 - 200 A
Breaking Capacity I1 50 kA ~ / 8 kA ==
Fusing characteristic gR

D&D0 FUSE LINKS

Description:

Fuse-links are the oldest protective devices in the electrical industry. The protection by fuses is based on the principle a piece of wire melting at the point of defect of an electric circuit. For this purpose a sufficient amount of energy is necessary, which is called the Joule integral I^2t . In order to adapt the fuse-links to specific protection requirements, various time current characteristics have been developed. A time current characteristic is a graphical representation of the melting time as a function of the overload current. The type of fuse is chosen based on the operational range of the fuse and the type of object under protection.

Marks

Fuse marking consists of two letters where the first letter denotes the function class and the second the type of facility under protection.

Example: gG; g: protects a facility across the entire current axis; G: the facility under protection is electrical installation.

Function class of fuses

It determines the range on the current axis for which a fuse-link is capable of breaking a circuit.

Function class g

The entire range of operation of a fuse. Fuse-links continuously conduct rated currents and in case of a defect in the circuit they break all currents from the lowest melting current up to the highest breaking capacity (protection against overload and short circuits).

Function class a

These fuses provide limited range of protection. Fuse-links conduct continuously the rated currents and in case of a defect in the circuit they break all currents from a multiple of rated current up to the breaking current (protection against short circuits).

Facilities under protection

L: cables and mains
 B: mining equipment
 M: switching devices
 R: semiconductors
 T: transformers

The types of fuse-links used for protection of the specified objects

gG: total range of protection -cable and mains
 aM: partial range of protection -switching devices
 aR: partial range of protection – semiconductors
 gR: total range of protection – semiconductors
 gB: total range of protection -mining equipment
 gTr: total range of protection -transformers

Semiconductors in rectifiers require quick fuse-links of type aR and gR for protection. ULTRA-QUICK fuse-links comply with the following regulations: VDE 0636/23, VDE 0636/33, IEC 60269, DIN 57636, DIN 43620, DIN43653, DIN 49522.

The requirements with which fuse-links for protection of semiconductors must comply are:

- high breaking capacity and quick action
- high current limitation
- low watts loss
- they should not be subject to ageing

ULTRA QUICK fuse-links provide optimum protection of semiconductors, being used for special purposes:

A: $I_{pol} \leq I_{Ntv}$

The current passing through the semiconductor must be smaller or the same as the rated current of the fuse-link. Here you have to consider special ways of load (periodical, non-periodical, uniform, non-uniform) and other influences (thermal influences, cooling).

B: $U_{pol} \leq U_{Ntv}$

The operating voltage on the semiconductor must be smaller or the same as the rated voltage of the fuse-link. In case of doubt the rated voltage of the semiconductor element to be protected can be used as a guideline.

C: $\int i_{pol}^2 dt > \int i_{Ntv}^2 dt$

The total Joule-integral of the chosen fuse-link $I^2 dt$ must be lower than the limit integral of the semiconductor. If this data is not directly stated, it can be calculated from the data for the maximum permissible surge forward current for the duration of one-half period (10ms)- I_{TSM} in the following way:

$$\int i_{POL}^2 dt = \frac{(I_{TSM})^2}{2} T$$

D: $I_k < I_{Ntv}$

The highest possible surge forward current of the short circuit which can appear in a circuit must be lower than the rated breaking capacity of the fuse-link.

E: $U_{RRM} > U_L$ $U_{DRM} > U_L$

The switching voltage (arc voltage) of the fuse-link must be lower than the repetitive peak voltage of the semiconductor in the negative or positive direction.

D&D0 CROSS REFERENCE TABLE

Size	Class	Rating	Bussmann	Ferraz Shawmut	ETI	M Schneider	Siemens	SIBA	Weber	Bals		
D01		2	2NZ01	1700.002	2211001	0810	5SE2 202	10 027 04 2A	8 111 100 281	910		
		4	4NZ01	1700.004	2211002	0811	5SE2 204	10 027 04 4A	8 111 100 481	911		
		6	6NZ01	1700.006	2211003	0812	5SE2 206	10 027 04 6A	8 111 100 681	912		
		10	10NZ01	1700.01	2211004	0813	5SE2 210	10 027 04 10A	8 111 101 081	913		
		13	13NZ01	1700.013	-	-	081301	-	-	-	-	
D02		16	16NZ01	1700.016	2211005	0814	5SE2 216	10 027 04 16A	8 111 101 681	914		
		20	20NZ02	1701.02	2212001	0815	5SE2 220	10 028 04 20A	8 111 202 081	915		
		25	25NZ02	1701.025	2212002	0816	5SE2 225	10 028 04 25A	8 111 202 581	916		
		32	32NZ02	1701.032	2212006	0817	-	-	8 111 203 581	-		
		35	35NZ02	1701.035	2212003	0818	5SE2 235	10 028 04 35A	-	917		
		40	40NZ02	-	2212007	-	-	-	-	-		
		50	50NZ02	1701.05	2212004	0818	5SE2 250	10 028 04 50A	8 111 205 081	918		
D03		63	63NZ02	1701.063	2212005	0819	5SE2 263	10 028 04 63A	8 111 206 381	919		
		80	80NZ02	1702.08	2213001	0820	-	10 029 04 80A	2 111 308 081	-		
DI / E16	D01	100	100NZ02	1702.1	2213002	0821	-	10 029 04 100A	2 111 310 081	-		
		2	2D16	594.0027	2311401	0207	5SA2 11	10 002 04 2A	2 118 800 201	927		
		4	4D16	594.0047	2311402	0208	5SA2 21	10 002 04 4A	2 118 800 401	928		
		6	6D16	594.0067	2311403	0209	5SA2 31	10 002 04 6A	2 118 800 601	929		
		10	10D16	594.0107	2311404	0210	5SA2 51	10 002 04 10A	2 118 801 001	9210		
		16	16D16	594.0167	2311405	0211	5SA2 61	10 002 04 16A	2 118 801 601	9211		
		20	20D16	594.0207	2311406	0212	5SA2 71	10 002 04 20A	2 118 802 002	9212		
		25	25D16	594.0257	2311407	0213	5SA2 81	10 002 04 25A	2 118 802 501	9213		
		DII / E27		2	2D27	597.0027	2312401	028001	5SB2 11	10 005 04 2A	8 115 200 231	9214
				4	4D27	597.0047	2312402	028101	5SB2 21	10 005 04 4A	8 115 200 431	9215
6	6D27			597.0067	2312403	028201	5SB2 31	10 005 04 6A	8 115 200 631	9216		
10	10D27			597.0107	2312404	028301	5SB2 51	10 005 04 10A	8 115 201 031	9217		
16	16D27			597.0167	2312405	028501	5SB2 61	10 005 04 16A	8 115 201 631	9218		
20	20D27			597.0207	2312406	028601	5SB2 71	10 005 04 20A	8 115 202 031	9219		
DIII / E33		25	25D27	597.0257	2312407	028701	5SB2 81	10 005 04 25A	8 115 202 531	9220		
		32	32D33	598.0327	2313404	-	-	-	-	-		
		35	35D33	598.0357	2313401	0288	5SB4 11	10 007 04 35A	8 115 303 501	9221		
		40	40D33	-	2313405	-	-	-	-	-		
		50	50D33	598.0507	2313402	0289	5SB4 21	10 007 04 50A	8 115 305 001	9222		
DIV / R 1 1/4"		63	63D33	598.0637	2313403	0290	5SB4 31	10 007 04 63A	8 115 306 301	9223		
		80	80D125	598.0807	2314401	0268	5SC2 11	10 009 04 80A	-	-		
DIV / R 2"		100	100D125	595.1007	2314402	0269	5SC2 21	10 009 04 100A	-	-		
		125	125D200	595.1257	2315401	0270	-	10 010 04 125A	-	-		
		160	160D200	596.1607	2315402	0271	-	10 010 04 160A	-	-		
		200	200D200	596.2007	2315403	0272	-	10 010 04 200A	-	-		

Size	Class	Rating	Bussmann	Ferraz Shawmut	ETI	M Schneider	Siemens	SIBA	Weber	Bals
DI / E16		2	2D16Q	594.002	2312101	0200	5SA1 11	10 002 01 2A	2 114 800 201	-
		4	4D16Q	594.004	2312102	0201	5SA1 21	10 002 01 4A	2 114 800 401	-
		6	6D16Q	594.006	2312103	0202	5SA1 31	10 002 01 6A	2 114 800 601	-
		10	10D16Q	594.01	2312104	0203	5SA1 51	10 002 01 10A	2 114 801 001	-
		16	16D16Q	594.016	2312105	0204	5SA1 61	10 002 01 16A	2 114 801 601	-
		20	20D16Q	594.02	2312106	0205	5SA1 71	10 002 01 20A	2 114 802 001	-
DII / E27	Fast Acting	25	25D16Q	594.025	2312107	0206	5SA1 81	10 002 01 25A	2 114 802 501	-
		2	2D27Q	597.002	2311101	022001	5SB1 11	-	8 111 200 231	-
		4	4D27Q	597.004	2311102	022101	5SB1 21	-	8 111 200 431	-
		6	6D27Q	597.006	2311103	022201	5SB1 31	-	8 111 200 631	-
		10	10D27Q	597.01	2311104	022301	5SB1 51	-	8 111 201 031	-
		16	16D27Q	597.016	2311105	022501	5SB1 61	-	8 111 201 631	-
		20	20D27Q	597.02	2311106	022601	5SB1 71	-	8 111 202 031	-
DIII / E33		25	25D27Q	597.025	2311107	022701	5SB1 81	-	8 111 202 531	-
		35	35D33Q	598.035	2313101	0228	5SB3 11	-	8 111 303 501	-
		50	50D33Q	598.05	2313102	0229	5SB3 21	-	8 111 305 001	-
DIV / R 1 1/4"		63	63D33Q	598.063	2313203	0230	5SB3 31	-	8 111 306 301	-
		80	80D125Q	-	2314101	0231	5SC1 11	-	-	-
DV / R 2"		100	100D125Q	-	2314102	0232	5SC1 21	-	-	-
		125	125D200Q	-	2315101	0235	-	-	-	-
		160	160D200Q	-	2315102	0236	-	-	-	-
		200	200D200Q	-	2315103	0237	-	-	-	

D&D0 CROSS REFERENCE TABLE

Size	Class	Rating	Bussmann	Ferraz Shawmut	ETI	M Schneider	Siemens	SIBA	Weber	Bals
D01	Ultra Rapid	2	2NZ01R	1700.0026	4311001	011 002	-	10 027 07 2A	-	-
		4	4NZ01R	1700.0046	4311002	011 004	-	10 027 07 4A	-	-
		6	6NZ01R	1700.0066	4311003	011 006	-	10 027 07 6A	-	-
		10	10NZ01R	1700.0106	4311004	011 010	-	10 027 07 10A	-	-
D02		16	16NZ01R	1700.0166	4311005	011 016	-	10 027 07 16A	-	-
		20	20NZ02R	1701.0206	4312001	012 020	-	10 028 07 20A	-	-
		25	25NZ02R	1701.0256	4312002	012 025	-	10 028 07 25A	-	-
		35	35NZ02R	1701.0356	4312003	012 035	-	10 028 07 35A	-	-
DI / E16		50	50NZ02R	1701.0506	4312004	012 050	-	10 028 07 50A	-	-
		63	63NZ02R	1701.0636	4312005	012 063	-	10 028 07 63A	-	-
		2	2D16R	-	4321001	013 002	-	10 002 07 2A	-	-
		4	4D16R	-	4321002	013 004	-	10 002 07 4A	-	-
		6	6D16R	-	4321003	013 006	-	10 002 07 6A	-	-
		10	10D16R	-	4321004	013 010	-	10 002 07 10A	-	-
		16	16D16R	-	4321005	013 016	-	10 002 07 16A	-	-
DII / E27		20	20D16R	-	4321006	013 020	-	10 002 07 20A	-	-
		25	25D16R	-	4321007	013 025	-	10 002 07 25A	-	-
		2	2D27R	597.0028	4322001	014 002	-	10 005 07 2A	2 175 200 201	-
		4	4D27R	597.0048	4322002	014 004	-	10 005 07 4A	2 175 200 401	-
		6	6D27R	597.0068	4322003	014 006	-	10 005 07 6A	2 175 200 601	-
	10	10D27R	597.0108	4322004	014 010	-	10 005 07 10A	2 175 201 001	-	
	16	16D27R	597.0168	4322005	014 016	5SD4 20	10 005 07 16A	2 175 201 601	-	
DII / E33	20	20D27R	597.0208	4322006	014 020	5SD4 30	10 005 07 20A	2 175 202 001	-	
	25	25D27R	597.0258	4322007	014 025	5SD4 40	10 005 07 25A	2 175 202 501	-	
	30	25D27R	597.0308	4322008	-	5SD4 80	10 005 07 30A	-	-	
	35	35D33R	598.0358	4323001	015 035	5SD4 50	10 007 07 35A	2 175 203 501	-	
	50	50D33R	598.0508	4323002	015 050	5SD4 60	10 007 07 50A	2 175 205 001	-	
DIV / R 1 ¼"	63	63D33R	598.0638	4323003	015 063	5SD4 70	10 007 07 63A	2 175 206 301	-	
	80	80D125R	598.0808	4324001	016 080	5SD5 10	10 009 07 80A	-	-	
DV / R 2"	100	100D125R	598.1008	4324002	016 100	5SD5 20	10 009 07 100A	-	-	
	125	125D200R	596.1258	4325001	017 125	-	10 010 07 125A	-	-	
	160	160D200R	596.1608	4325002	017 160	-	10 010 07 160A	-	-	
	200	200D200R	596.2008	4325002	017 200	-	10 010 07 200A	-	-	