



W58 series

Push To Reset Only Thermal Circuit Breaker



Features

- 0.5 amp to 30 amp ratings.
- Cannot be manually tripped.
- Button extends for visual trip indication.
- Push button to reset breaker.
- Termination is screw or .250" QC.

Agency Approvals

W58 Series is UL 1077 Recognized as Supplementary Protectors, File E69543, and CSA Accepted as Supplementary Protectors (Appliance Component Protectors), File LR15734.

Users should thoroughly review the technical data before selecting a product part number. It is recommended that users also seek out the pertinent approvals files of the agencies/laboratories and review them to ensure the product meets the requirements for a given application.

Maximum Resistance vs. Current Rating @ +25°C

Current Rating in Amps	Maximum Resistance in Ohms	Current Rating in Amps	Maximum Resistance in Ohms
0.5	5.0	8	0.020
1	1.35	9	0.020
2	0.32	10	0.014
3	0.18	12	0.010
4	0.10	15	0.010
5	0.026	20	0.005
6	0.026	25	0.006
7	0.020	30*	0.004

*No UL/CSA

Electrical Data @ +25°C

Calibration: Breaker will continuously carry 100% of rated load. It may trip between 101% and 145% of rated load, but must trip at 145% at 25°C.

Dielectric Strength: Over 1,500 volts RMS.

Maximum Operating Voltages: 50VDC; 250VAC.

Interrupt Capacity: 2,000 amps at 50VDC (0.5 - 30 amp models).
1,000 amps at 250VAC (0.5 - 30 amp models).

Note: 30 amp model not UL or CSA.

Resettable Overload Capacity: Ten times rated current.

Mechanical/Environmental Data

Shock: Withstands to 10g.

Endurance Cycling: Over 1,000 cycles at 200% of rated load.

Vibration: Withstands to 10g at 10-55 Hz.

Weight: Less than 1 1/2 oz. (42.5g).

Time vs. Current Trip Curve @ +25°C

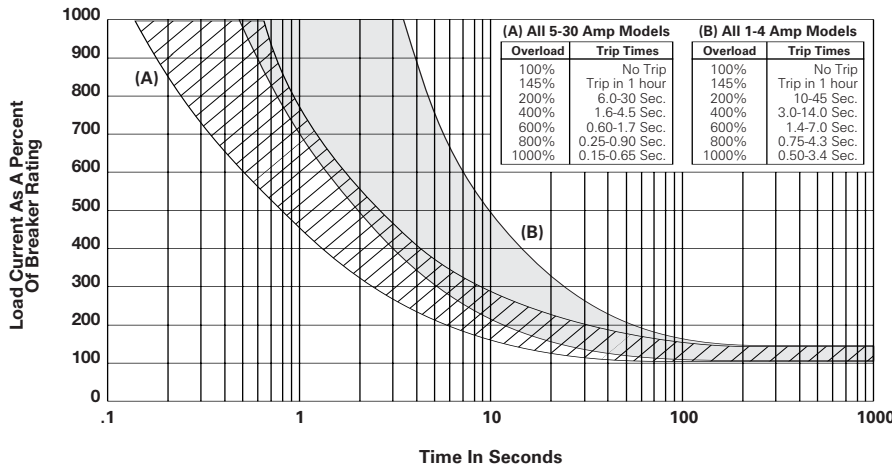

Ambient Compensation Chart

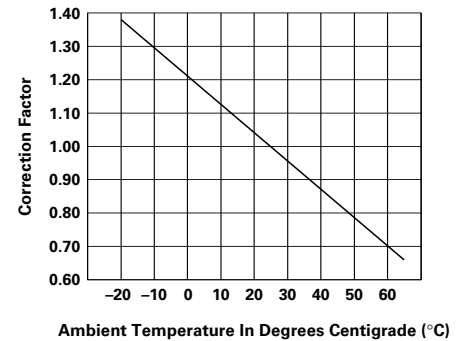

To use this chart: Read up from the ambient temperature to the curve, and across to find a correction factor. Multiply the breaker rating by the correction factor to determine the compensated rating. Calculate the overloads in terms of the compensated rating to use the published trip curve.

Ordering Information

	W	58	-X	B	1	A	4	A	-5																		
<p>1. Designator: W = Circuit breaker</p> <p>2. Series Number: 58 = Single Pole, Push-to-Reset</p> <p>3. Circuit Function: X = Series Trip</p> <p>4. Button: A = White, plain, no rate marking, no trip band E = White with red rate marking no trip band B = White with red rate marking, red trip band F = White with black rate marking, no trip band C = White with black rate marking, red trip band</p> <p>5. Mounting Bushing: 1 = 7/16" x .500" (12.70mm) long 4 = 15/32" x .300" (7.62mm) long, black 6 = 3/8" x .465" (11.81mm) long, round</p> <p>6. Terminals: A = Quick connect .250" (6.35mm) straight C = 6/32 screw 90° (screws installed) D = 6/32 screw 90° (screws bulk packed)</p> <p>7. Mounting Hardware: 4 = Knurled nut/hex nut 15 = Two hex nuts/lock washer 6 = Knurled nut/hex nut/lock washer 99 = No mtg. hardware supplied (Use C, Step #8) 12 = Knurled nut/lock washer</p> <p>Note: For other hardware combinations, order separately. See mounting hardware Ordering Information table.</p> <p>8. Mounting Hardware Packaging: A = Assembled to bushing B = Bulk unassembled C = No mounting hardware</p> <p>9. Specify Amp Rating:</p> <table style="width:100%; border-collapse: collapse;"> <tr> <td style="width:10%;">0.5</td> <td style="width:10%;">3</td> <td style="width:10%;">6</td> <td style="width:10%;">9</td> <td style="width:10%;">15</td> <td style="width:10%;">30*</td> </tr> <tr> <td>1</td> <td>4</td> <td>7</td> <td>10</td> <td>20</td> <td></td> </tr> <tr> <td>2</td> <td>5</td> <td>8</td> <td>12</td> <td>25</td> <td></td> </tr> </table> <p style="text-align:right; font-size:small;">*Not UL or CSA</p>										0.5	3	6	9	15	30*	1	4	7	10	20		2	5	8	12	25	
0.5	3	6	9	15	30*																						
1	4	7	10	20																							
2	5	8	12	25																							

Stock Items – Authorized distributors are more likely to stock the following items.

W58-XB1A4A-1	W58-XB1A4A-6	W58-XB1A4A-15	W58-XC4C12A-2	W58-XC4C12A-15
W58-XB1A4A-2	W58-XB1A4A-7	W58-XB1A4A-20	W58-XC4C12A-3	W58-XC4C12A-20
W58-XB1A4A-3	W58-XB1A4A-8	W58-XB1A4A-25	W58-XC4C12A-5	W58-XC4C12A-25
W58-XB1A4A-4	W58-XB1A4A-10	W58-XB1A4A-30	W58-XC4C12A-7	W58-XC4C12A-30
W58-XB1A4A-5	W58-XB1A4A-12	W58-XC4C12A-1	W58-XC4C12A-10	

Outline Dimensions

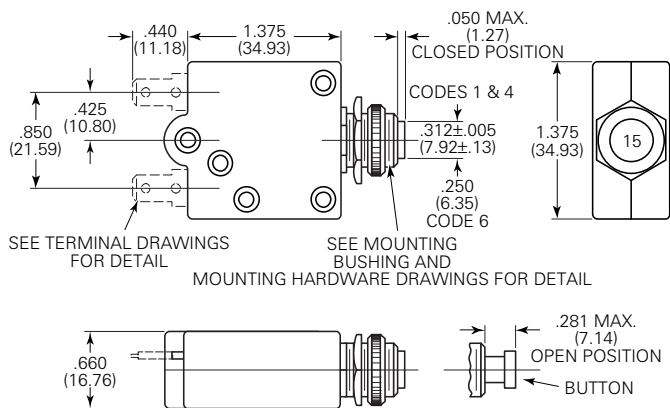

Terminal Options

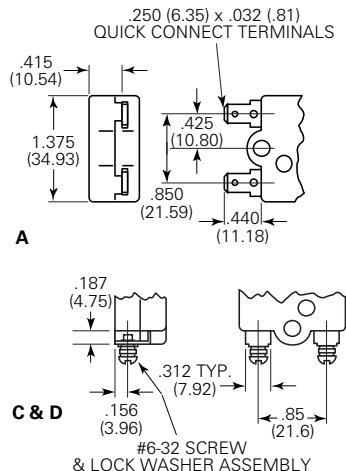

Mounting Hardware

Disc

Hex Nut

Knurled Nut

Lockwasher

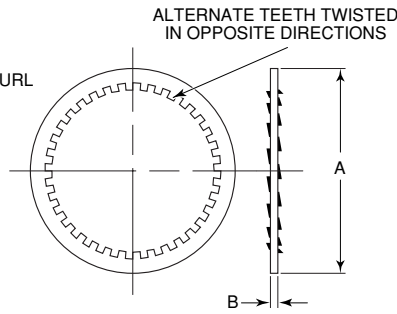
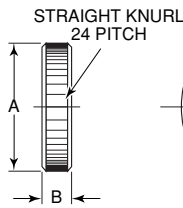
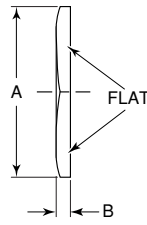
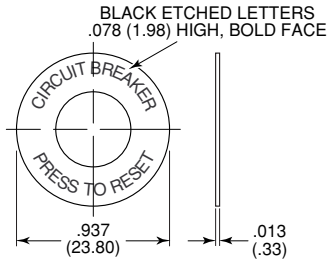

Mounting Bushing

Type 1

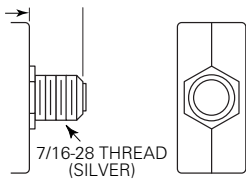

Recommended Cutout

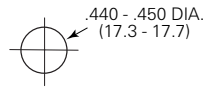

Type 4

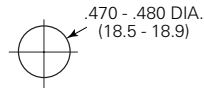
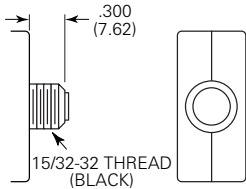

Type 6

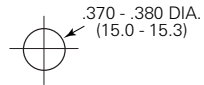
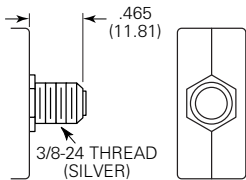

Mounting Hardware Dimensions

Dimension		Hex Nut	Knurled Nut	Lockwasher
A.	3/8"	.556	.562	.562
	7/16"	.625	.625	.540
	15/32"	.556	.625	.600
B.	3/8"	.085	.078	.018
	7/16"	.111	.125	.022
	15/32"	.078	.125	.018

Mounting Hardware Ordering Information

Mounting Bushing Code	Knurled Nut	Hex Nut	Lock Washer	Push to Reset Disc
1	55-010A	55-011A	88-021B	33-012A
4	•	55-001B	88-002A	33-012C
6	55-008A	55-001D	88-006K	33-012B

• 55-010B (silver) 55-010E (black)