

Description

Model d 3-pole thermal overload relays are designed to protect a.c. circuits and motors against overloads, phase failure, long starting times and prolonged stalling of the motor.

LRD-01...35

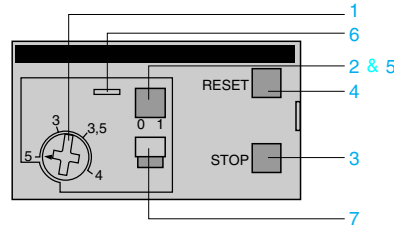

LRD-3322...4369, LR2-D

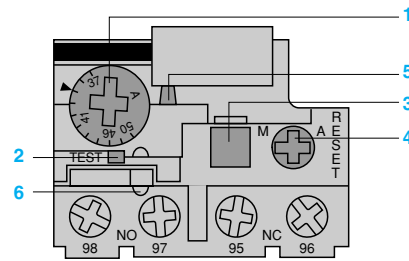

- 1 Adjustment dial Ir
- 2 Test button
Operation of the Test button allows:
- checking of control circuit wiring,
- simulation of relay tripping (actuates both the N/O and N/C contacts).
- 3 Stop button. Actuates the N/C contact; does not affect the N/O contact.
- 4 Reset button
- 5 Trip indicator
- 6 Setting locked by sealing the cover.
- 7 Selector for manual or automatic reset. Relays LRD-01 to 35 are supplied with the selector in the manual position, protected by a cover. Deliberate action is required to move it to the automatic position.

2

2.3

Environment

Conforming to standards		EN 60947-1, EN 60947-4-1, NF C 63-650, VDE 0660
Product certifications		CSA, UL, Sichere Trennung, PTB except LAD-4: UL, CSA.
Degree of protection	Conforming to VDE 0106	Protection against direct finger contact IP 2X
Protective treatment	Conforming to IEC 68	"TH"
Ambient air temperature around the device	Storage	°C - 60...+ 70
	Normal operation, without derating (IEC 947-4-1)	°C - 20...+ 60
	Minimum and maximum operating temperatures (with derating)	°C - 40...+ 70
Operating positions without derating	In relation to normal, vertical mounting plane	Any position
Shock resistance	Permissible acceleration conforming to IEC 68-2-7	15 gn - 11 ms
Vibration resistance	Permissible acceleration conforming to IEC 68-2-6	6 gn
Dielectric strength at 50 Hz	Conforming to IEC 255-5	kV 6
Impulse withstand voltage	Conforming to IEC 801-5	kV 6

Auxiliary contact characteristics

Conventional thermal current		A	5					
Maximum consumption of operating coils of controlled contactors (Occasional operating cycles of contact 95-96)	a.c. supply	V	24	48	110	220	380	600
		VA	100	200	400	600	600	600
	d.c. supply	V	24	48	110	220	440	—
		W	100	100	50	45	25	—
Short-circuit protection	By gG or BS fuse. Max. rating or by GB2 circuit-breaker	A	5					
Connection to screw clamp terminals	Flexible cable without cable end	1 or 2 conductors	mm ² Min/max c.s.a. 1/2.5					
	Flexible cable with cable end	1 or 2 conductors	mm ² 1/2.5					
	Solid cable without cable end	1 or 2 conductors	mm ² 1/2.5					
	Tightening torque		N.m 1.7					
	Connection to spring terminals	Flexible cable without cable end	1 or 2 conductors	mm ² Min/max c.s.a. 1/2.5				
Solid cable without cable end		1 or 2 conductors	mm ² 1/2.5					

Electrical characteristics of power circuit

Relay type			LRD-01 to 16 LR3-D01 to D16	LR2-D15●●	LRD-21 to 35 LR3-D21 to D35	LR2-D25●●	LRD-3322 to 33696 LR3-D3322 to D33696	LR2-D35●●	LRD-4365 to 4369
Tripping class	To UL 508, EN 60947-4-1		10 A	20	10 A	20	10 A	20	10 A
Rated insulation voltage (U_i)	Conforming to EN 60947-4-1	V	690		690		1000		1000
	Conforming to UL, CSA	V	600		600		600		600 except LRD-4369
Rated impulse withstand voltage (U_{imp})		kV	6		6		6		6
Frequency limits	Of the operational current	Hz	0...400		0...400		0...400		0...400
Setting range	Depending on model	A	0.1...13		12...38		17...104		80...140
Connection to screw clamp terminals Flexible cable without cable end	1 conductor	mm ²	Min/max c.s.a. 1.5/10		1.5/10		4/35		4/50
	Flexible cable with cable end	1 conductor	1/4		1/6 except LRD-21: 1/4		4/35		4/35
	Solid cable without cable end	1 conductor	1/6		1.5/10 except LRD-21: 1/6		4/35		4/50
Tightening torque		N.m	1.7	1.85	2.5		9		9
Connection to spring terminals Flexible cable without cable end	1 conductor	mm ²	Min/max c.s.a. 1.5/4		1.5/4		-		-
	Solid cable without cable end	1 conductor	1.5/4		1.5/4		-		-

Operating characteristics

Temperature compensation		°C	-20...+60	-30...+60-	-30...+60	-20...+60
Tripping threshold	Conforming to EN 60947-4-1	A	1.14 ± 0.06 I _n			
Sensitivity to phase failure	Conforming to EN 60947-4-1		Tripping current 30 % of I _n on one phase, the others at I _n			

Average operating time
related to multiples of the current setting

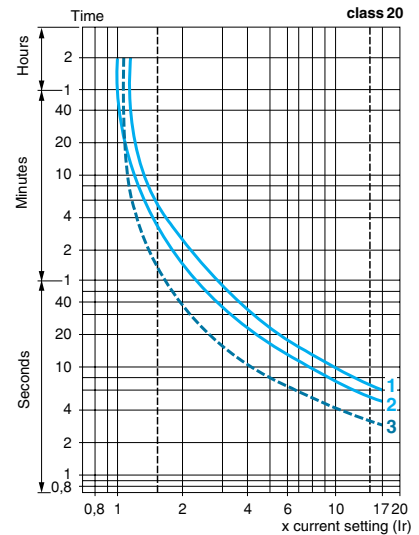
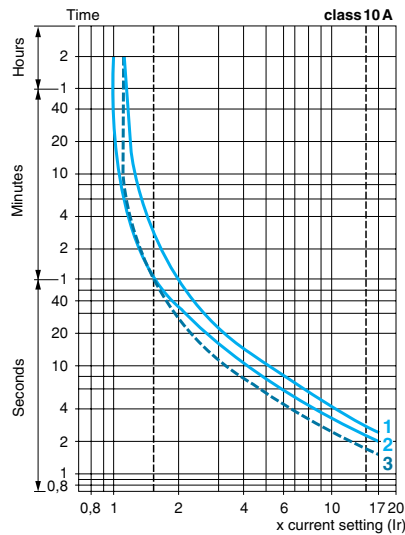

- 1 Balanced operation, 3-phase, from cold state.
- 2 Balanced operation, 2-phase, from cold state.
- 3 Balanced operation, 3-phase, after a long period at the set current (hot state).

Description

LR9-D electronic thermal overload relays are designed for use with contactors LC1-D115 and D150.

In addition to the protection provided by model d thermal overload relays (see page 2/108) they offer the following special features:

- Protection against phase imbalance.
- Choice of starting class.
- Protection of unbalanced circuits.
- Protection of single-phase circuits.
- Alarm function to avoid tripping by load shedding.

2

LR9-D5367...D5569

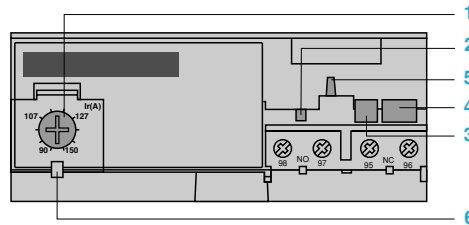

LR9-D67 and D69

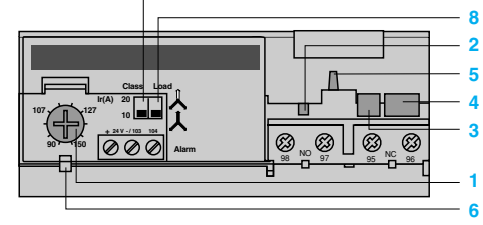

- 1 Setting dial Ir
- 2 Test button
- 3 Stop button
- 4 Reset button
- 5 Trip indication
- 6 Setting locked by sealing the cover
- 7 Class 10/class 20 selector
- 8 Selector for balanced load unbalanced load

2.3

Environment

Conforming to standards			EN 60947-4-1, 255-8, 255-17, VDE 0660
Product certifications			UL 508 , CSA 22-2
Degree of protection	Conforming to IEC 529 and VDE 0106		IP 20 on front face with protective covers LA9-D11570● or D11560●
Protective treatment	Standard version		"TH"
Ambient air temperature around the device (conforming to IEC 255-8)	Storage	°C	- 40...+ 85
	Normal operation	°C	- 20...+ 55 (1)
Maximum operating altitude	Without derating	m	2000
Operating positions without derating	In relation to normal, vertical mounting plane		Any position
Shock resistance	Permissible acceleration conforming to IEC 68-2-27		13 gn - 11 ms
Vibration resistance	Permissible acceleration conforming to IEC 68-2-6		2 gn - 5 to 300 Hz
Dielectric strength at 50 Hz	Conforming to IEC 255-5	kV	6
Impulse withstand voltage	Conforming to IEC 1000-4-5	kV	6
Resistance to electrostatic discharge	Conforming to IEC 1000-4-2	kV	8
Resistance to radio-frequency conducted disturbances	Conforming to IEC 1000-4-3 and NF C 46-022	V/m	10
Resistance to fast transient currents	Conforming to IEC 1000-4-4	kV	2
Electromagnetic compatibility	Draft EN 50081-1 and 2, EN 50082-2		Meets requirements

Electrical characteristics of auxiliary contacts

Conventional thermal current		A	5					
Maximum consumption of operating coils of controlled contactors (Occasional operating cycles of contact 95-96)	a.c. supply	V	24	48	110	220	380	600
		VA	100	200	400	600	600	600
Short-circuit protection	d.c. supply	V	24	48	110	220	440	–
		W	100	100	50	45	25	–
Cabling Flexible cable without cable end	By gG or BS fuse or by GB2 circuit-breaker	A	5					
	1 or 2 conductors	mm²	Minimum c.s.a.: 1/maximum c.s.a.: 2.5					
	Tightening torque	N.m	1.2					

(1) For operation at 70 °C, please call our Customer information centre on 0870 608 8 608.

2

2.3

Electrical characteristics of power circuit

Relay type			LR9-D
Tripping class	Conforming to UL 508, EN 60947-4-1		10 A or 20
Rated insulation voltage (U_i)	Conforming to EN 60947-4-1	V	1000
	Conforming to UL, CSA	V	600
Rated impulse withstand voltage (U_{imp})		kV	8
Frequency limits	Of the operational current	Hz	50...60. For other frequencies, call our Customer information centre on 0870 608 8 608 (1)
Setting range	Depending on model	A	60...150
Power circuit connections	Width of terminal lug	mm	20
	Clamping screw		M8
	Tightening torque	N.m	18

Operating characteristics

Temperature compensation		°C	- 20...+ 70
Tripping thresholds	To EN 60947-4-1	A	1.05 ± 0.06 I _n
	Alarm Tripping	A	1.12 ± 0.06 I _n
Sensitivity to phase failure	Conforming to EN 60947-4-1		Tripping in 4 s ± 20 % in the event of phase failure

Alarm circuit characteristics

Rated supply voltage	d.c. supply	V	24
Supply voltage limits		V	17...32
Current consumption	No load	mA	≤ 5
Switching capacity		mA	0...150
Protection	Short-circuit and overload		Self-protected
Voltage drop	Closed state	V	≤ 2.5
Cabling	Flexible cable without cable end	mm²	0.5...1.5
Tightening torque		N.m	0.45

Average operating time
related to multiples of the current setting

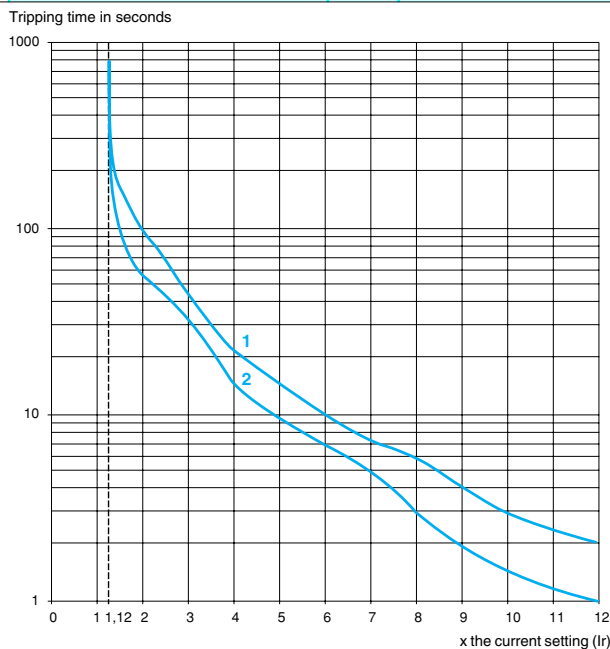

(1) For use of these relays with soft start units or variable speed controllers, please call our Customer information centre on 0870 608 8 608.

Differential thermal overload relays for use with fuses. Class 10 A tripping

- Compensated relays with manual or automatic reset,
- with relay trip indicator,
- for a.c. or d.c.



LRD-08



LRD-21



LRD-33●●



LRD-083

Relay setting range A	Fuses to be used with selected relay			For use with contactor LC1-	Reference	Weight kg
	aM	gG	BS88			

Class 10 A (1) with connection by screw clamp terminals

0.10...0.16	0.25	2	—	D09...D38	LRD-01	0.124
0.16...0.25	0.5	2	—	D09...D38	LRD-02	0.124
0.25...0.40	1	2	—	D09...D38	LRD-03	0.124
0.40...0.63	1	2	—	D09...D38	LRD-04	0.124
0.63...1	2	4	—	D09...D38	LRD-05	0.124
1...1.7	2	4	6	D09...D38	LRD-06	0.124
1.6...2.5	4	6	10	D09...D38	LRD-07	0.124
2.5...4	6	10	16	D09...D38	LRD-08	0.124
4...6	8	16	16	D09...D38	LRD-10	0.124
5.5...8	12	20	20	D09...D38	LRD-12	0.124
7...10	12	20	20	D09...D38	LRD-14	0.124
9...13	16	25	25	D12...D38	LRD-16	0.124
12...18	20	35	32	D18...D38	LRD-21	0.124
16...24	25	50	50	D25...D38	LRD-22	0.124
23...32	40	63	63	D25...D38	LRD-32	0.124
30...38	50	80	80	D32 and D38	LRD-35	0.124
17...25	25	50	50	D40...D95	LRD-3322	0.510
23...32	40	63	63	D40...D95	LRD-3353	0.510
30...40	40	100	80	D40...D95	LRD-3355	0.510
37...50	63	100	100	D40...D95	LRD-3357	0.510
48...65	63	100	100	D50...D95	LRD-3359	0.510
55...70	80	125	125	D50...D95	LRD-3361	0.510
63...80	80	125	125	D65 and D95	LRD-3363	0.510
80...104	100	160	160	D80 and D95	LRD-3365	0.510
80...104	125	200	160	D115 and D150	LRD-4365	0.900
95...120	125	200	200	D115 and D150	LRD-4367	0.900
110...140	160	250	200	D150	LRD-4369	0.900
80...104	100	160	160	(2)	LRD-33656	1.000
95...120	125	200	200	(2)	LRD-33676	1.000
110...140	160	250	200	(2)	LRD-33696	1.000

Class 10 A (1) with spring terminal connections (for direct mounting on the contactor only)

0.10...0.16	0.25	2	—	D09...D38	LRD-013	0.140
0.16...0.25	0.5	2	—	D09...D38	LRD-023	0.140
0.25...0.40	1	2	—	D09...D38	LRD-033	0.140
0.40...0.63	1	2	—	D09...D38	LRD-043	0.140
0.63...1	2	4	—	D09...D38	LRD-053	0.140
1...1.6	2	4	6	D09...D38	LRD-063	0.140
1.6...2.5	4	6	10	D09...D38	LRD-073	0.140
2.5...4	6	10	16	D09...D38	LRD-083	0.140
4...6	8	16	16	D09...D38	LRD-103	0.140
5.5...8	12	20	20	D09...D38	LRD-123	0.140
7...10	12	20	20	D09...D38	LRD-143	0.140
9...13	16	25	25	D12...D38	LRD-163	0.140
12...18	20	35	32	D18...D38	LRD-213	0.140
16...24	25	50	50	D25...D38	LRD-223	0.140

Class 10 A (1) with connection by lug-clamps

Select the appropriate overload relay with screw clamp terminals from the table above and add 6 to the end of the reference. Example: LRD-01 becomes LRD-016.

Thermal overload relays for use with unbalanced loads

Class 10 A (1) with connection by screw clamp terminals

Change the prefix in the references above from LRD (except LRD-4●●●) to LR3-D. Example: LRD-01 becomes LR3-D01.

Thermal overload relays for use on 1000 V supplies

Class 10 A (1) with connection by screw clamp terminals

For relays LRD-01 to LRD-35 only, for an operating voltage of 1000 V, and only for independent mounting, the reference becomes LRD-33●●A66. Example: LRD-12 becomes LRD-3312A66.

Order an LA7-D3064 terminal block separately, see page 2/115.

(1) Standard IEC 947-4-1 specifies a tripping time for 7.2 times the setting current I_r : class 10 A: between 2 and 10 seconds.

(2) Independent mounting.

Differential thermal overload relays for use with fuses. Class 20 tripping

- Compensated relays with manual or automatic reset,
 - with relay trip indicator,
 - for a.c. or d.c.
 - LR2-D1508 to 2553: independent mounting
 - either by ordering a terminal block **LA7-D1064** or **LA7-D2064**, see page 2/115,
 - or by ordering the the relay pre-assembled; in this case add the suffix **LA7** to the reference.
- Example: **LR2-D1508** becomes **LR2-D1508LA7**.

Relay setting range	Fuses to be used with the selected relay			For use with contactor LC1	Reference	Weight kg
	aM	gG	BS88			
A	A	A	A			



LR2-D1508

Class 20 (1) for connection by screw clamp terminals

2.5...4	6	10	16	D09...D32	LR2-D1508	0.190
4...6	8	16	16	D09...D32	LR2-D1510	0.190
5.5...8	12	20	20	D09...D32	LR2-D1512	0.190
7...10	16	20	25	D09...D32	LR2-D1514	0.190
9...13	16	25	25	D12...D32	LR2-D1516	0.190
12...18	25	35	40	D18...D32	LR2-D1521	0.190
17...25	32	50	50	D25 and D32	LR2-D1522	0.190
23...32	40	63	63	D25 and D32	LR2-D2553	0.345
17...25	32	50	50	D40...D95	LR2-D3522	0.535
23...32	40	63	63	D40...D95	LR2-D3553	0.535
30...40	50	100	80	D40...D95	LR2-D3555	0.535
37...50	63	100	100	D50...D95	LR2-D3557	0.535
48...65	80	125	100	D50...D95	LR2-D3559	0.535
55...70	100	125	125	D65...D95	LR2-D3561	0.535
63...80	100	160	125	D80 and D95	LR2-D3563	0.535

Electronic differential thermal overload relays for use with fuses. Class 10 A or 20

- Compensated relays,
- with relay trip indicator,
- for a.c. or d.c.,
- for direct mounting on contactor or independent mounting (2).

Relay setting range	Fuses to be used with selected relay		For direct mounting beneath contactor LC1	Reference	Weight kg
	aM	gG			
A	A	A			



LR2-D2508

Class 10 or 10A (1) with connection using bars or connectors

60...100	100	160	D115 and D150	LR9-D5367	0.885
90...150	160	250	D115 and D150	LR9-D5369	0.885

Class 20 (3) with connection using bars or connectors

60...100	125	160	D115 and D150	LR9-D5567	0.885
90...150	200	250	D115 and D150	LR9-D5569	0.885

Electronic thermal overload relays for use with balanced or unbalanced loads

- Compensated relays,
- with separate outputs for alarm and tripping.

Relay setting range	Fuses to be used with the selected relay		For direct mounting beneath contactor LC1	Reference	Weight kg
	aM	gG			
A	A	A			

Class 10 A or 20 (1) selectable with connection using bars or connectors

60...100	100	160	D115 and D150	LR9-D67	0.900
90...150	160	250	D115 and D150	LR9-D69	0.900

(1) Standard IEC 947-4-1 specifies a tripping time for 7.2 times the setting current I_n

class 10: between 4 and 10 seconds,

class 10 A: between 2 and 10 seconds,

class 20: between 6 and 20 seconds.

(2) Power terminals can be protected against direct finger contact by the addition of shrouds and/or insulated terminal blocks, to be ordered separately (see page 2/90).

Other versions

Thermal overload relays for resistive circuits in category AC-1.
Please call our Customer information centre on 0870 608 8 608.

2

2.3

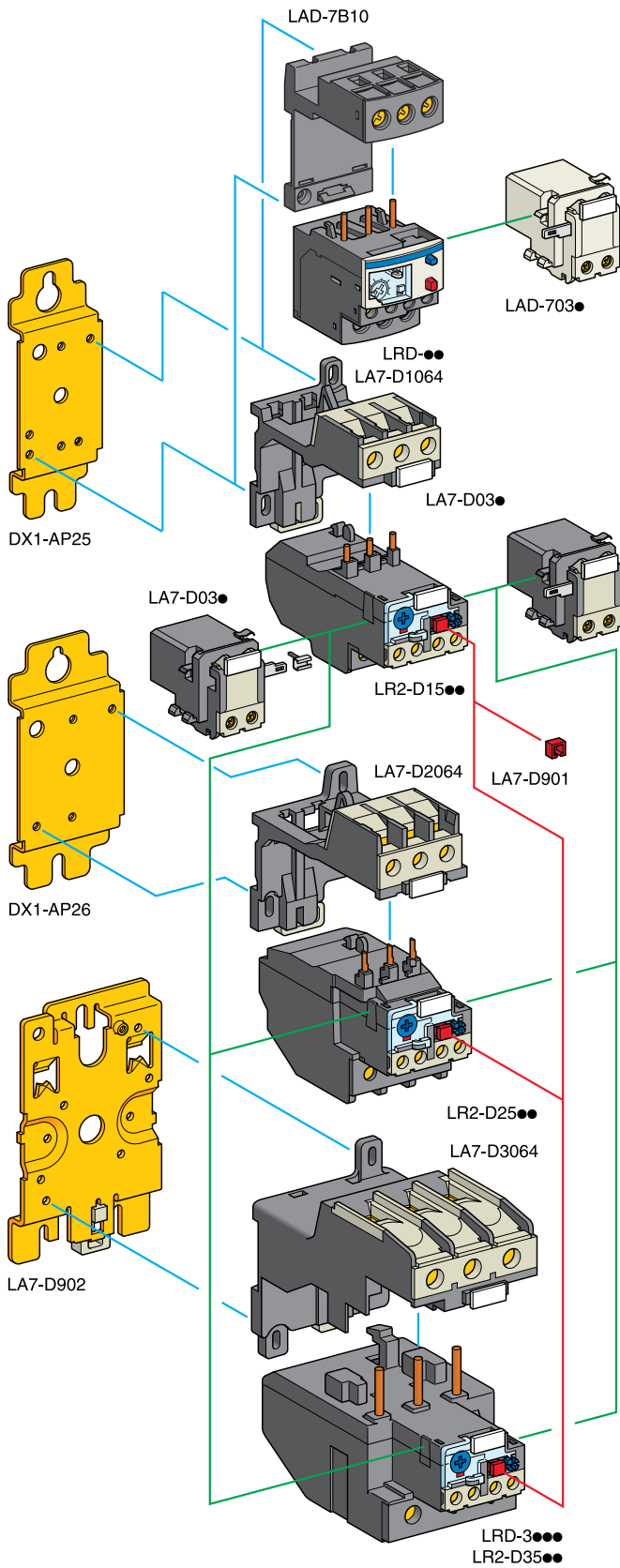

DX1-AP25

DX1-AP26

LA7-D902

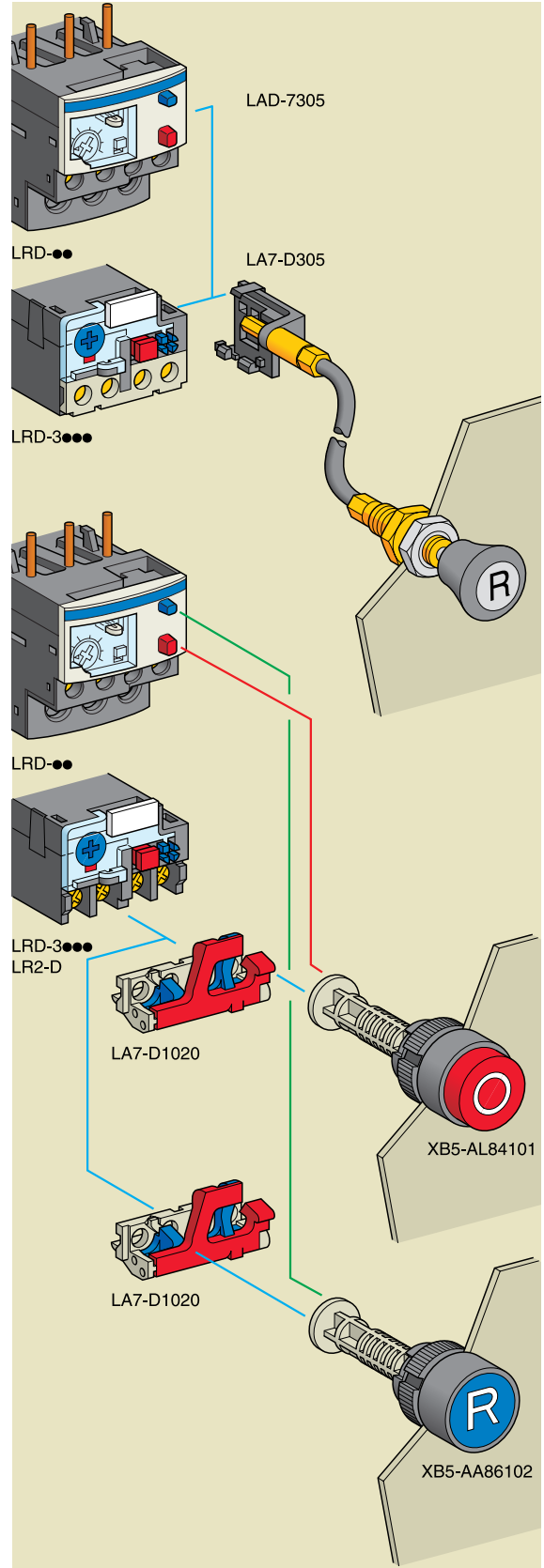

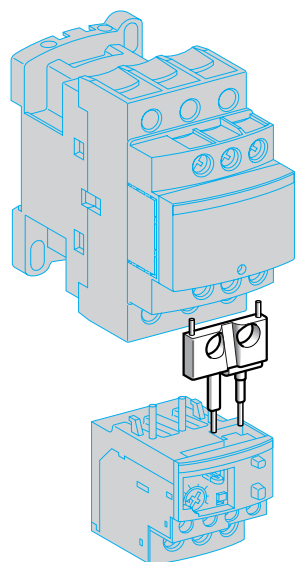

LAD-7C●

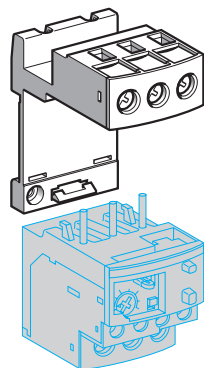

LAD-7B10

Accessories (to be ordered separately)

Description	For use on	Sold in lots of	Unit reference	Weight kg
Pre-wiring kit allowing direct connection of the N/C contact of relay LRD-01...35 or LR3-D01...D35 to the contactor	LC1-D09...D18	10	LAD-7C1	0.002
	LC1-D25...D38	10	LAD-7C2	0.003
Terminal blocks (1) for clip-on mounting on 35 mm rail (AM1-DP200) or screw fixing; for fixing centres, see pages 2/116 to 2/118	LRD-01...35 and LR3-D01...D35	1	LAD-7B10	0.100
	LR2-D15●●	1	LA7-D1064	0.100
	LR2-D25●●	1	LA7-D2064	0.120
	LRD-3●●●, LR3-D3●●●, LR2-D35●●	1	LA7-D3064 (2)	0.370
Terminal block adapter for mounting a relay beneath an LC1-D115 or D150 contactor	LRD-3●●●, LR3-D3●●●, LRD-35●●	1	LA7-D3058	0.080
Mounting plates (3) for screw fixing on 110 mm centres	LRD-01...35, LR3-D01...D35, LR2-D15●●	10	DX1-AP25	0.065
	LR2-D25●●	10	DX1-AP26	0.082
	LRD-3●●●, LR3-D3●●●, LR2-D35●●	1	LA7-D902	0.130
Marker holder snap in	All relays except LRD-01...35 and LR3-D01...D35 (4)	100	LA7-D903	0.001
Bag of 400 labels (blank, self-adhesive, 7 x 16 mm)	–	1	LA9-D91	0.001
Stop button locking device	All relays except LRD-01...35, LR3-D01...D35 and LR9-D	10	LA7-D901	0.005
Remote stop or electrical reset device (5)	LRD-01...35 and LR3-D01...D35	1	LAD-703● (6)	0.090
Remote tripping or electrical reset device (5)	All relays except LRD-01...35 and LR3-D01...D35	1	LA7-D03●(6)	0.090
Block of insulated terminals	LR9-D	2	LA9-F103	0.560

Remote control

“Reset” function

By flexible cable (length = 0.5 m)	LRD-01...35 and LR3-D01...D35	1	LAD-7305 ▲	0.075
	All relays except LRD-01...35 and LR3-D01...D35	1	LA7-D305	0.075

“Stop” and/or “Reset” functions

The terminal protection shroud must be removed and the following 3 products must be ordered separately.

Adapter for door interlock mechanism	All relays except LRD-01...35 and LR3-D01...D35	1	LA7-D1020	0.005
---	---	---	-----------	-------

Operating head for spring return pushbutton	Stop	All relays	1	XB5-AL84101	0.027
	Reset	All relays	1	XB5-AA86102	0.027

(1) Terminal blocks are supplied with terminals protected against direct finger contact and screws in the open, “ready-to-tighten” position.

(2) To order a terminal block for connection by lugs, the reference becomes LA7-D30646.

(3) Do not forget to order the terminal block corresponding to the type of relay.

(4) For LRD-01...35, see page 2/91.

(5) The time for which the coil of remote tripping or electrical resetting device LA7-D03 or LAD-703 can remain energised depends on its rest time: 1 s pulse duration with 9 s rest time; 5 s pulse duration with 30 s rest time; 10 s pulse duration with 90 s rest time; maximum pulse duration of 20 s with a rest time of 300 s. Minimum pulse time: 200 ms.

(6) Reference to be completed by adding the code indicating control circuit voltage.

Control circuit voltages (for other voltages, please call our Customer information centre on 0870 608 8 608).

Volts	12	24	48	96	110	220/230	380/400	415/440
50/60 Hz	–	B	E	–	F	M	Q	N
Consumption, inrush and sealed: < 100 VA	–	J	B	E	DD	F	M	–
Consumption, inrush and sealed: < 100 W.	–	–	–	–	–	–	–	–

▲ Available
January 2002

Illustrations:
page 2/114

Dimensions:
pages 2/116 to 2/118

2

LRD-01...35

Direct mounting beneath contactors with screw clamp connections

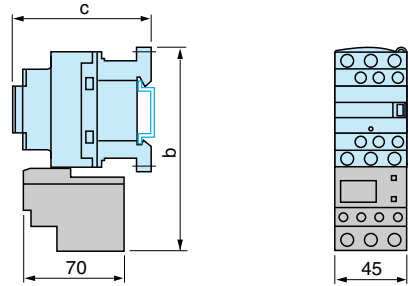

LRD-013...353

Direct mounting beneath contactors with spring terminal connections

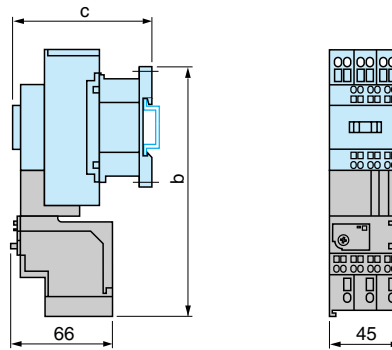

LC1-	D09...D18	D25...D38
b	123	137
c	see pages 2/94 and 2/95	

LC1-	D093...D383
b	168
c	see pages 2/94 and 2/95

2.3

LRD-3●●●

Direct mounting beneath contactors
LC1-D40 to D95 and LP1-D40 to D80

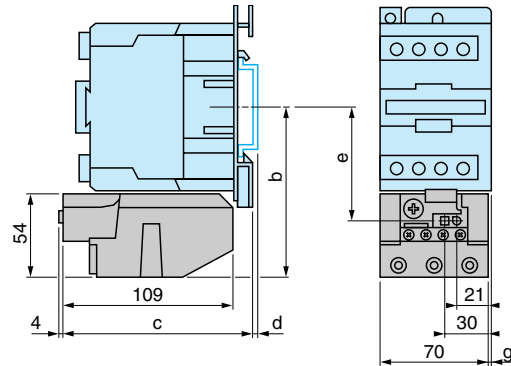

AM1-	DL201	DL200
d	7	17

	b	c	e	g (3P)	g (4P)
--	---	---	---	--------	--------

Control circuit: a.c.

LC1-D40	111	119	72.4	4.5	13
LC1-D50	111	119	72.4	4.5	-
LC1-D65	111	119	72.4	4.5	13
LC1-D80	115.5	124	76.9	9.5	22
LC1-D95	115.5	124	76.9	9.5	-

Control circuit: d.c.

LC1-D40, LP1-D40	111	176	72.4	4.5	13
LC1-D50	111	176	72.4	4.5	-
LC1-D65, LP1-D65	111	176	72.4	4.5	13
LC1-D80, D95, LP1-D80	115.5	179.4	76.9	9.5	22

LRD-4●●●

Direct mounting beneath contactors
LC1-D115 and D150

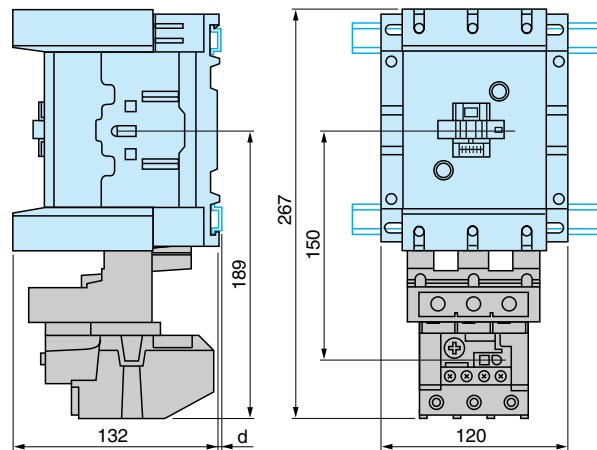

	AM1-DL200 and DR200	AM1-DE200 and ED●●●
d	2.5	10.5

LR9-D

Direct mounting beneath contactors
LC1-D115 and D150

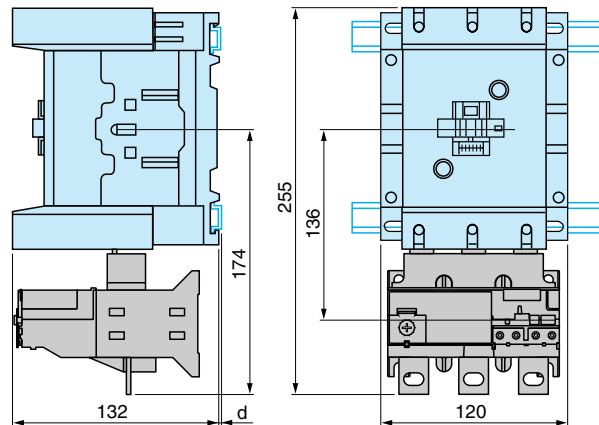

	AM1-DP200 and DR200	AM1-DE200 and ED●●●
d	2.5	10.5

Characteristics:
pages 2/108 to 2/111

References:
pages 2/112 and 2/113

Schemes:
page 2/119

LRD-01...35

Independent mounting on 50 mm centres
or on rail AM1-DP200 or DE200

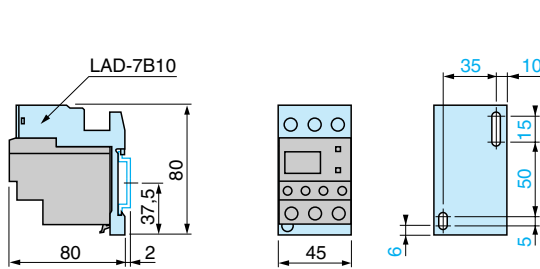

Independent mounting on 110 mm centres

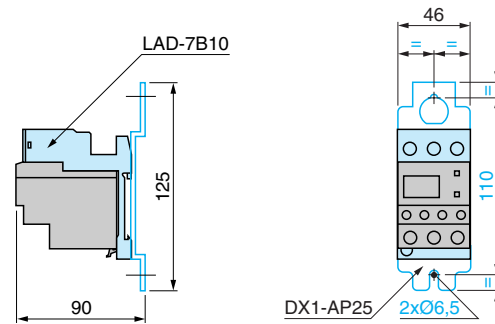

Remote tripping or electrical reset

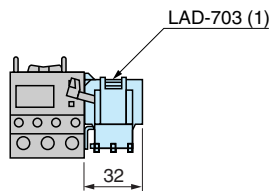

(1) Can only be mounted on RH side of relay LRD-01...35

LR2-D15●●

Independent mounting on 50 mm centres
or on rail AM1-DP200 or DE200

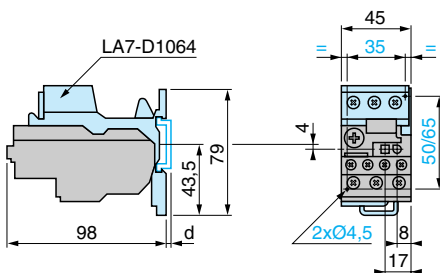

	AM1-DP200	AM1-DE200
d	2	9.5

Remote tripping or electrical reset

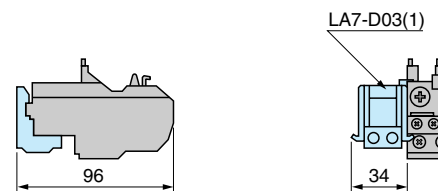

(1) Can be mounted on RH or LH side of relay LR2-D15●●

LR2-D25●●

Independent mounting on 50 mm centres
or on rail AM1-DP200 or DE200

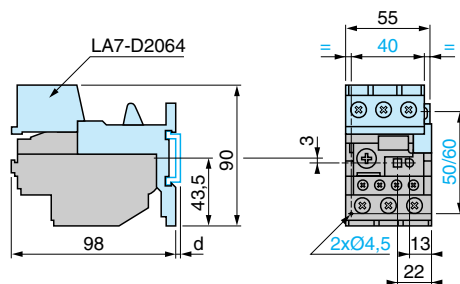

	AM1-DP200	AM1-DE200
d	2	9.5

Remote tripping or electrical reset

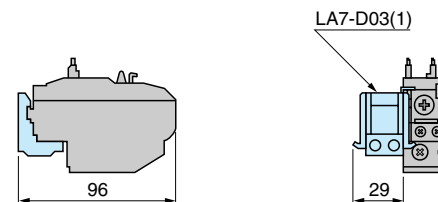

(1) Can be mounted on RH or LH side of relay LR2-D25●●

LRD-3●●● and LR2-D35●●

Independent mounting on 50 mm centres
or on mounting rail AM1-DP200 or DE200

LRD-3●●●, LR2-D35●● and LR9-D

Remote tripping or electrical reset

2

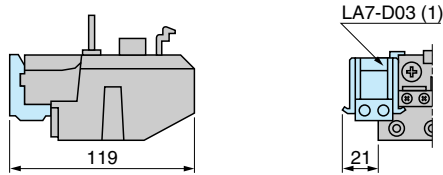
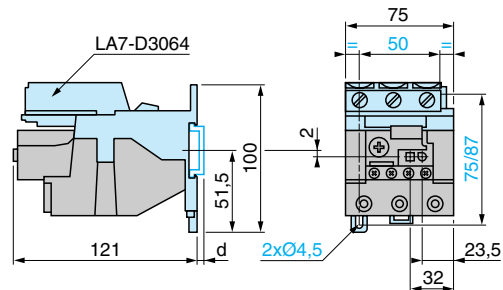

	AM1-DP200	AM1-DE200
d	2	9.5

(1) Can be mounted on RH or LH side of relays LRD-3●●●, LR2-D35●● or LR9-D

2.3

LR2-D and LRD-3●●●

Adapter for door interlock mechanism
LA7-D1020

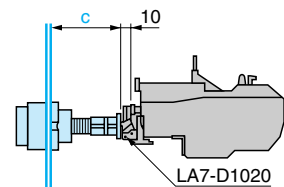

Stop

Reset

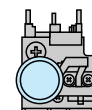
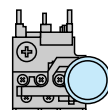

c: adjustable from 17 to 120 mm

LRD, LR2-D and LR9-D

"Reset" by flexible cable
LA7-D305 and LAD-7305
Mounting with cable straight

Mounting with cable bent

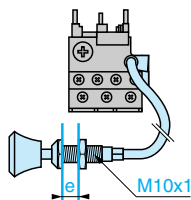
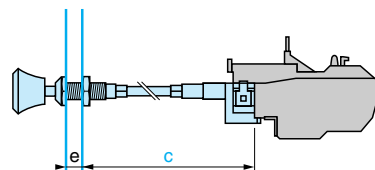

c: up to 550 mm
e: up to 20 mm

e: up to 20 mm

LRD, LR2-D and LR3-D

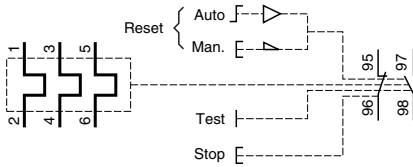

**Pre-cabling kit
LAD-7C1, LAD-7C2**

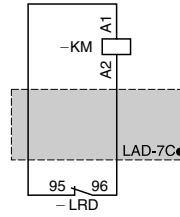

2

LR9-D5

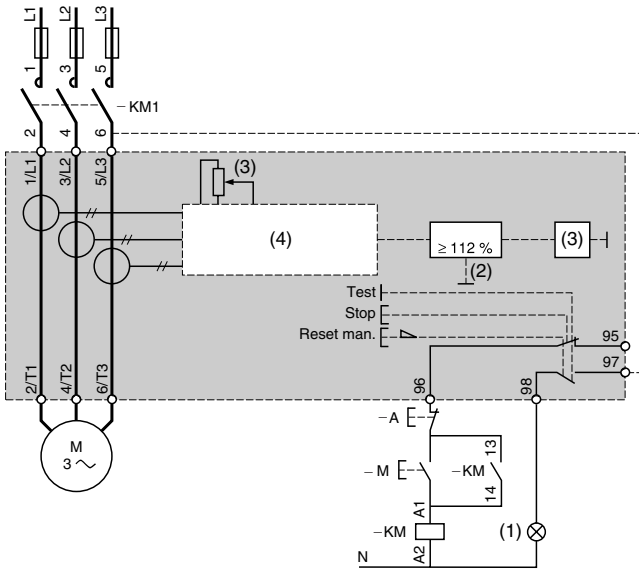

2.3

- (1) Tripped
- (2) Overload
- (3) Setting current
- (4) Specialised circuit

LR9-D67 and LR9-D69

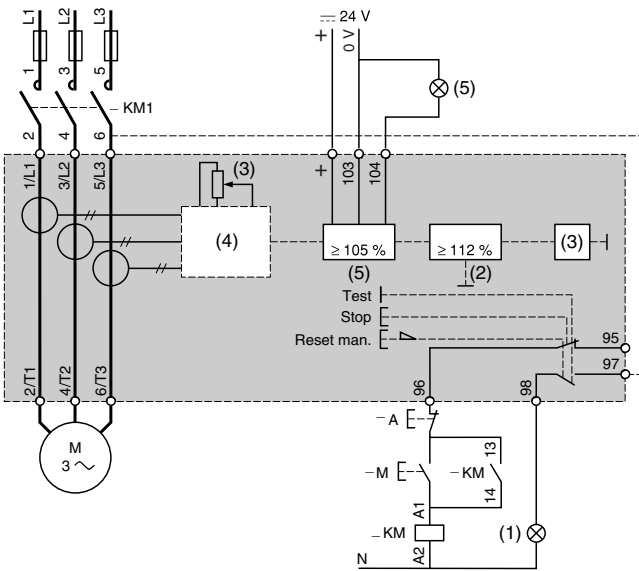

- (1) Tripped
- (2) Overload
- (3) Setting current
- (4) Specialised circuit
- (5) Alarm