

TX93A (J, K, T, E)



4-20 mA

ULTRA-MINI TEMPERATURE TRANSMITTER

Operator's Manual

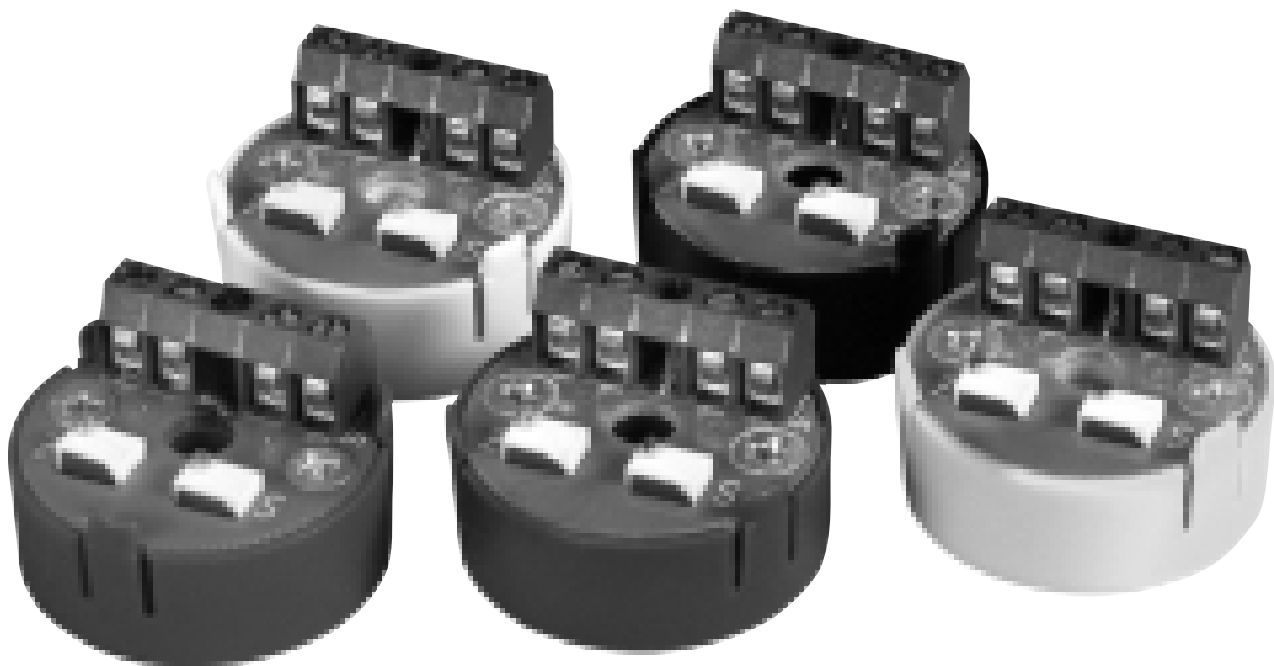

 NEWPORT Electronics, Inc.

<http://www.newportUS.com/manuals>



Additional products from

NEWPORT Electronics, Inc.

Counters	Rate Meters
Frequency Meters	Timers
PID Controllers	Totalizers
Clock/Timers	Strain Gauge Meters
Printers	Voltmeters
Process Meters	Multimeters
On/Off Controllers	Soldering Iron Testers
Recorders	pH pens
Relative Humidity	pH Controllers
Transmitters	pH Electrodes
Thermocouples	RTDs
Thermistors	Thermowells
Wire	Flow Sensors

For Immediate Assistance
In the U.S.A. and Canada: 1-800-NEWPORT®
In Mexico: (95) 800-NEWPORTSM
Or call your local NEWPORT Office.

NEWPORTnetSM On-Line Service

<http://www.newportUS.com>

Internet e-mail

info@newportUS.com

It is the policy of NEWPORT to comply with all worldwide safety and EMC/EMI regulations that apply. NEWPORT is constantly pursuing certification of its products to the European New Approach Directives. NEWPORT will add the CE mark to every appropriate device upon certification.

The information contained in this document is believed to be correct but NEWPORT Electronics, Inc. accepts no liability for any errors it contains, and reserves the right to alter specifications without notice.

WARNING: These products are not designed for use in, and should not be used for, patient connected applications.

PATENT NOTICE: The "Meter Case Bezel Design" is a trademark of NEWPORT Electronics, Inc., registered in the U.S.. This product is covered by one or more of the following patents: U.S. Pat. No. Des. 336,895; 5,274,577 / CANADA 2052599; 2052600 / ITALY 1249456; 1250938 / FRANCE BREVET No. 91 12756 / SPAIN 2039150; 2048066 / UK PATENT No. GB2 249 837; GB2 248 954 / GERMANY DE 41 34398 C2. OTHER INTERNATIONAL PATENTS PENDING.



This device is marked with the international caution symbol. It is important to read the Setup Guide before installing or commissioning this device as it contains important information relating to safety and EMC.

TABLE OF CONTENTS

Section 1	Getting Started	
	1.1 Unpacking	1
	1.2 Safety and EMC Considerations	1
	1.3 General Description	1
	1.4 Features	3
	1.5 Models Available	4
Section 2	Installation	
	2.1 Mounting	5
	2.2 Wiring	6
Section 3	Calibration Instructions	
	3.1 Equipment Required	7
	3.2 Set-up of Equipment.	7
	3.3 Calibration Procedures.	8
Section 4	Troubleshooting Guide	10
Section 5	Specifications	11

FIGURES & TABLES

Figure 1-1	Thermocouple Transmitter2
Figure 1-2	Straight Line Approximation of a Curve3
Figure 2-1	Assembly inside an NB2 Protection Head5
Figure 2-2	Wiring Diagram for Thermocouple Transmitter6
Figure 3-1	Transmitter Calibration Set-Up9
Figure 3-2	Transmitter Calibration Set- Up (Alternate)9
Figure 5-1	Dimensions11
Table 1-1	Range Code4
Table 1-2	Model Numbers4
Table 3-1	Calibration Values10

1.1 Unpacking

Remove the packing list and verify that you have received all equipment. If you have any questions, contact the nearest Customer Service Department, as listed on the cover of this manual.

Upon receipt of shipment, inspect the container and equipment for any signs of damage. Note any evidence of rough handling in transit. Immediately report any damage to the shipping agent.

Note

Note: The carrier will not honor any claims unless all shipping material is saved for their examination. After examining and removing contents, save packing materials and carton in the event reshipment is necessary.

1.2 Safety and EMC Considerations

This instrument is a Class III device (8 to 35 Vdc).

Always use a power supply, which complies with EN 60950 safety standard.

- Do not expose the transmitter to rain or condensing moisture.
- Do not operate the transmitter in flammable or explosive atmosphere.
- As with any electronic instrument, you may encounter high voltage exposure when installing, calibrating or removing parts of the transmitter.

EMC Considerations

- Whenever EMC is an issue, always use shielded cables.
- Never run signal and power wires in the same conduit.
- Use signal wire connections with twisted-pair cables.
- Install Ferrite Bead(s) on signal wires close to the instrument if EMC problems persist.

Failure to follow all instructions and warnings may result in injury!

1.3 General Description

The Thermocouple Two-Wire Temperature Transmitter accepts thermocouple sensor types J, K, T, or E and will produce a standard 4-20mA output signal proportional to that produced by its attached input temperature sensor. Transmission of the proportional current output may be accomplished by using inexpensive copper wire.

1.3 General Description (continued)

The transmitter is normally powered by an unregulated power supply as shown in **Figure 1-1**. The proportionally-transmitted signal begins at 4mA, at the low end of its temperature range, and increases to 20mA, at the high end of its temperature range. (There are various temperature ranges/ thermocouple types available for the transmitter. To order, refer to **Section 1.5** for correct Model Numbers and Range Codes.)

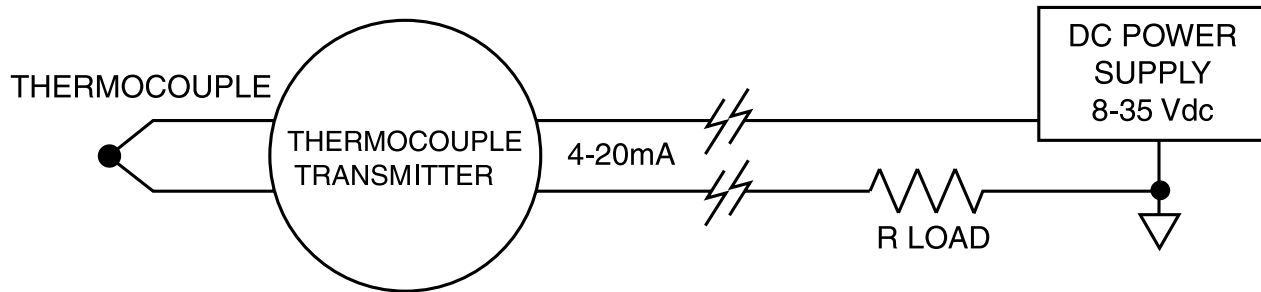

Figure 1-1 Thermocouple Transmitter

The two-wire transmitter receives and measures signals from thermocouples and sends an output current of 4-20mA which is directly proportional to the thermocouple millivolt input. It is designed to connect with only two copper wire leads that will supply the voltage to operate the transmitter from a power supply, and also carry the output current. The output current is used for recording, computing, or controlling.

If the transmitter is mounted inside a protection head, (see **Figure 2-1**), the thermocouple extension wires are replaced by two copper wires that carry the 4-20mA signal and dc voltage to operate the transmitter.

The transmitter has reverse supply polarity protection and will operate with a wide range of supply voltages (8 to 35 Vdc). It has an input sensor break protection circuit that forces the output current to go upscale when the thermocouple wire opens.

The transmitter does NOT provide isolation between its input and the 4-20 mA output; therefore, an ungrounded thermocouple junction is suggested to prevent possible ground loops.

1.3 General Description (continued)

Note

Most thermocouple transmitters with 4-20 mA outputs, including this transmitter, are proportional with respect to the thermocouple input voltage. However, the relationship between temperature and millivolt for all the thermocouple types is somewhat non-linear.

This leads to maximum error at approximately the midpoint of the range as shown in **Figure 1-2**.

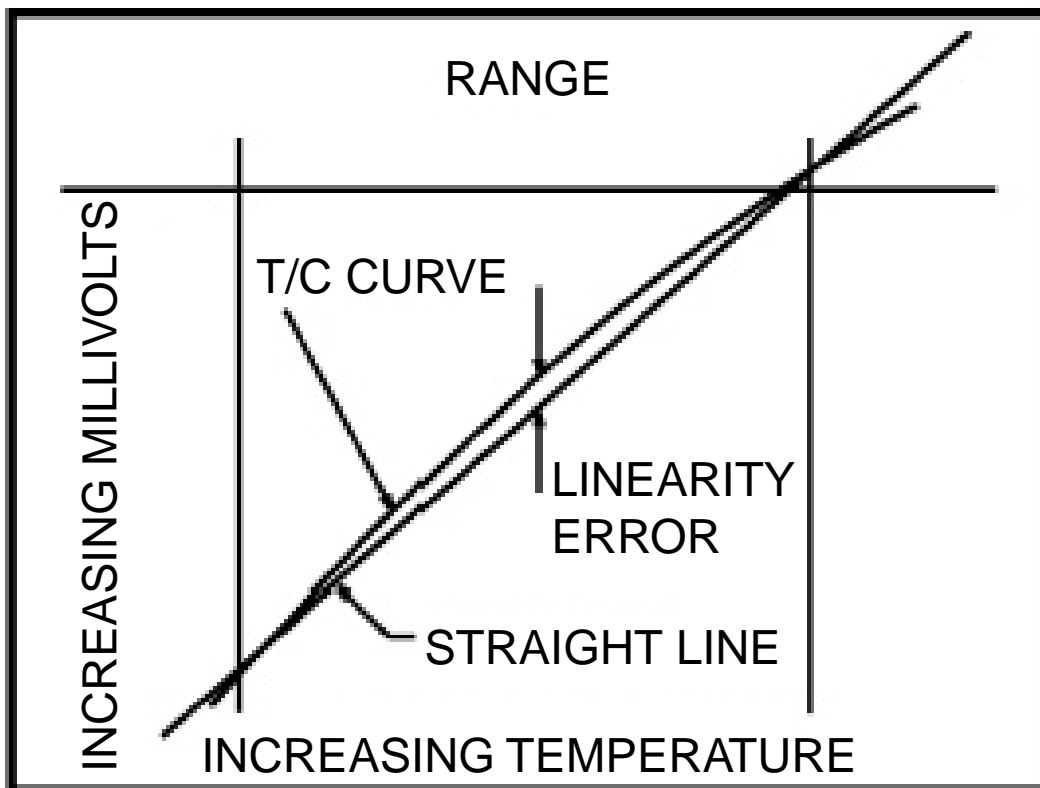

Figure 1-2 Straight Line Approximation of a Curve

1.4 Features

- 4-20 mA output
- +/-0.1% full-scale accuracy (with respect to the mV input signal)
- Upscale break protection
- Low Cost

1.5 Models Available

Table 1-1 Range Code

INPUT TYPES				
RANGE	J	K	T	E
-40 to 120 F (-40 to 49 C)	J1	-	-	E1
0 to 200 F (32 to 93 C)	J2	K2	T2	E2
0 to 300 F (32 to 149 C)	J3	K3	T3	E3
0 to 500 F (32 to 260 C)	J4	K4	T4	E4
0 to 750 F (32 to 399 C)	J5	K5	T5	E5
0 to 1000 F (32 to 538 C)	J6	K6	-	E6

Table 1-2 Model Numbers

Model Number	Description
TX93A-(*)	Thermocouple Transmitter (J, K, T, or E)
NB2TX93A-(*)	NB2 thermocouple probe, 12"L, 1/4" O.D., ungrounded junction, 304SS sheath

*Insert range code from **Table 1-1**

2.1 Mounting

The transmitter may be:

1. surface mounted
2. mounted inside a protection head (shown in **Figure 2-1**)

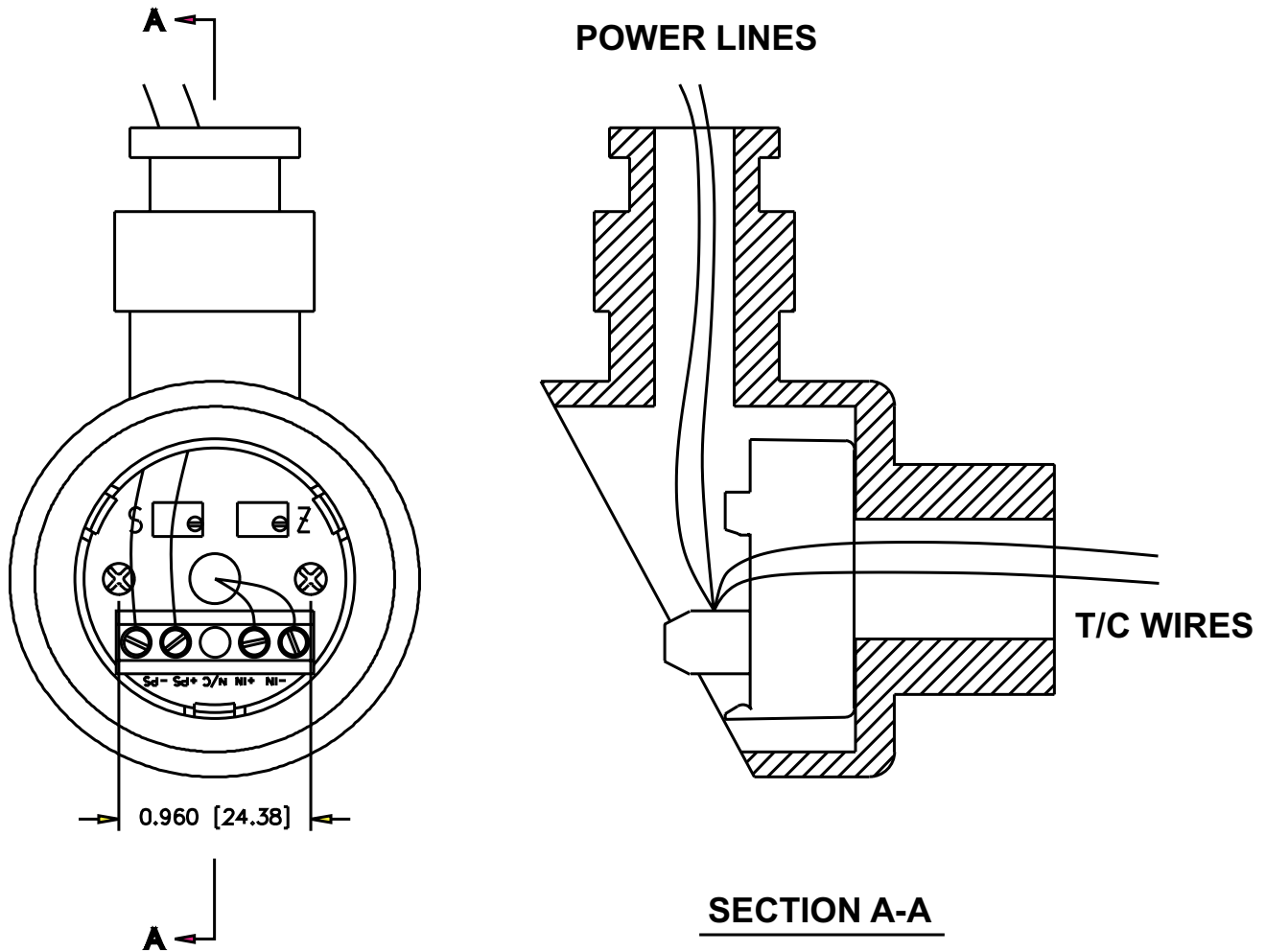

Figure 2-1 Assembly of the Transmitter inside an NB2 Protection Head

2.2 Wiring

Refer to **Figure 2-2**

1. Connect a dc power supply in series with the load to the (+PS) and (-PS) power terminals. Note that the load (usually a monitoring instrument) may be connected to either the (+) or (-) power lead.
2. Connect the thermocouple to the (+IN) and (-IN) input terminals.

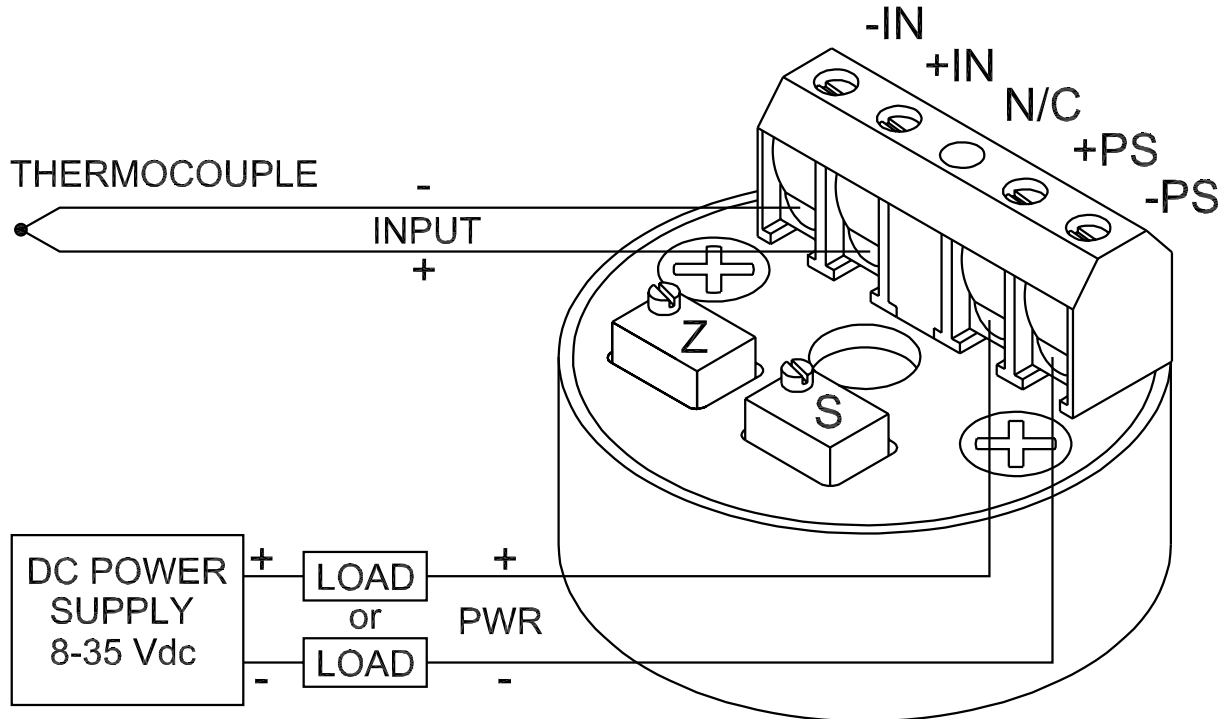

Figure 2-2 Wiring Diagram for Thermocouple Transmitter

3.1 Equipment Required

- Precision mV source, with 0.001 mV resolution and ± 0.002 mV accuracy
or
- Precision DVM with ± 0.002 mV accuracy and an adjustable mV source with 0.001 mV resolution
- OMEGA TRC III Ice Point Reference (or stable ice bath)
- Temperature Reference Probe Part Number: TRP-(*)
*Thermocouple Type J, K, T, E

3.2 Set-Up of Equipment

To prepare the ice bath: Refer to **Figure 3-1**

- a) Fill a glass beaker with crushed ice made from distilled water.
- b) Fill the beaker with enough distilled water so that the ice just becomes slush, but not enough to float the ice.
- c) Insert the reference thermocouple.

Figure 3-2 shows an alternate set-up. Here, a high precision thermocouple calibrator, such as the Model CL511, replaces the DVM, ice bath, voltage source, etc.

3.3 Calibration Procedures

Connect the calibration equipment according to **Figure 3-1** or **3-2**. The thermocouple wire must be of the same calibration as the transmitter being calibrated. Make sure that the wiring polarities are correct. (Note that the RED thermocouple wire is NEGATIVE).

To check or adjust the calibration:

1. Locate the Z (zero) and S (span) potentiometers.
2. Select, from Table 3-1, the correct mV input values for the Z (zero) and S (span) adjustments that correspond to the model number. For example, for Model TX93A-J2, the Z input is -0.886 mV, and the S input is 4.907 mV.

If a Thermocouple Calibrator/Simulator is used, such as the Model CL511 Precision Calibrator, select the Temperature Input Z (zero) and S (span) values.

3. Set the dc mV source to the selected Z (zero) mV value. Adjust the Z potentiometer to read 4.000 mA on the monitoring instrument.
4. Set the dc mV source to the selected S (span) mV value. Adjust the S potentiometer to read 20.000 mA on the monitoring instrument.
5. Repeat steps 3 and 4, as required, until the readings are exactly 4.000 mA and 20.000 mA. This procedure is necessary since there is interaction between the two potentiometers.

3.3 Calibration Procedures (continued)

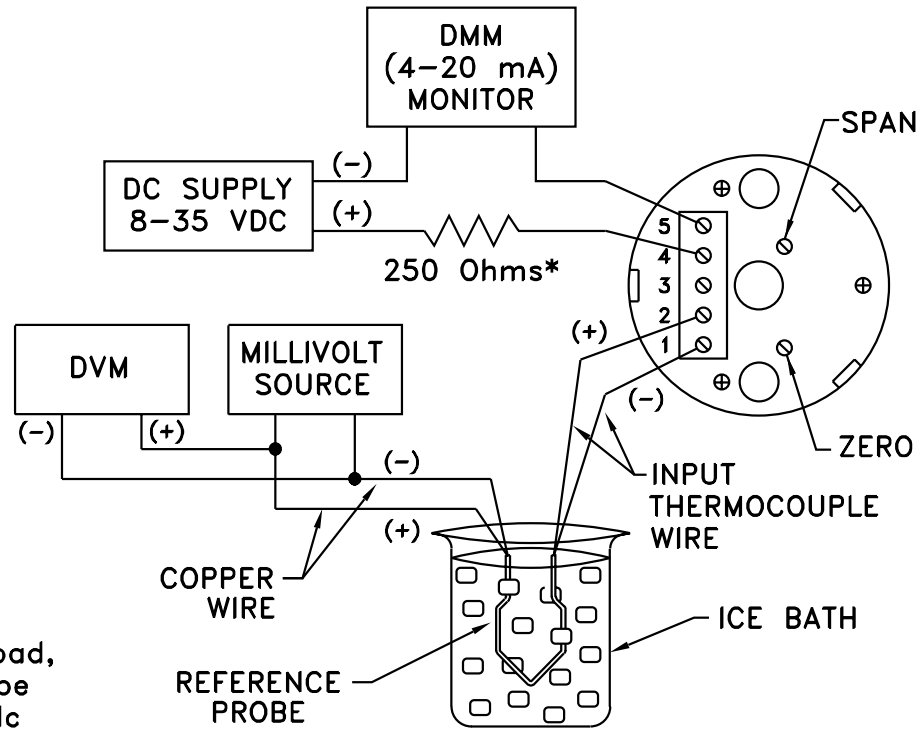

*With 250 Ohm load, dc supply must be at least 12-35Vdc

Figure 3-1 Transmitter Calibration Set-Up

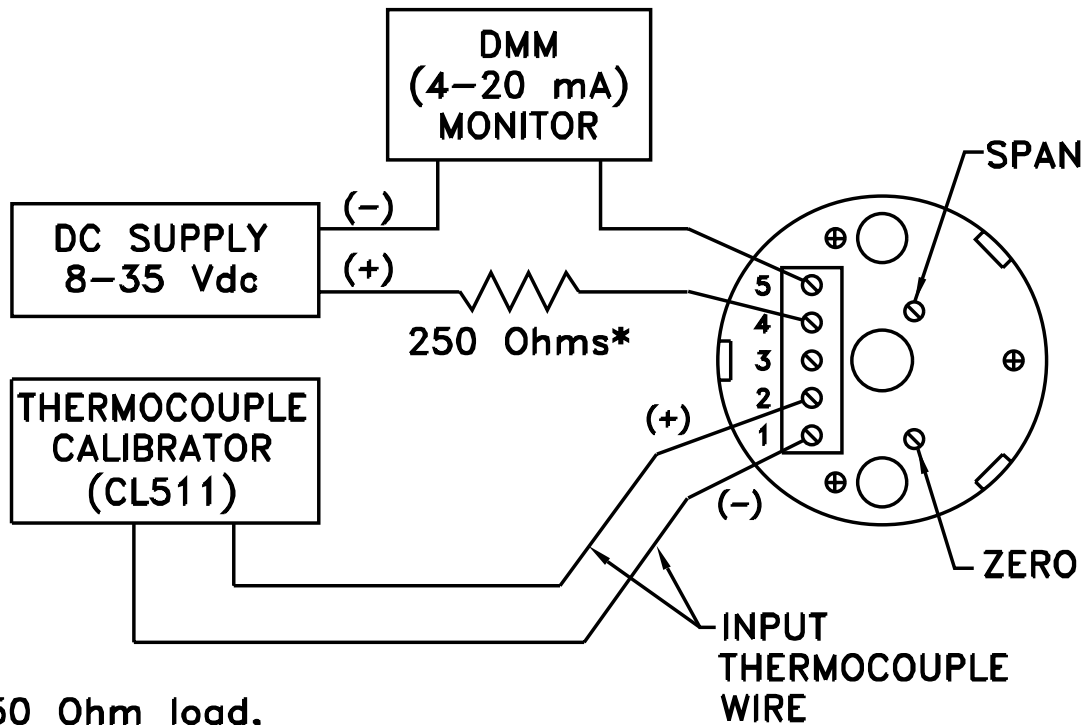

*With 250 Ohm load, dc supply must be at least 12-35Vdc

Figure 3-2 Transmitter Calibration Set-Up (Alternate)

Table 3-1. Calibration Values

Temperature Input Range Zero/Span	Model TX93A	mV Input Ref 32°F Zero/Span	Model TX93A	mV Input Ref 32°F Zero/Span
-40/120°F	-J1	-1.961/2.527	-	-
0/200°F	-J2	-0.886/4.907	-K2	-0.692/3.820
0/300°F	-J3	-0.886/7.949	-K3	-0.692/6.094
0/500°F	-J4	-0.886/14.110	-K4	-0.692/10.561
0/750°F	-J5	-0.886/21.787	-K5	-0.692/16.350
0/1000°F	-J6	-0.886/29.521	-K6	-0.692/22.255
<hr/>				
-40/120°F	–	–	-E1	-2.255/2.977
0/200°F	-T2	-0.675/3.968	-E2	-1.026/5.871
0/300°F	-T3	-0.675/6.648	-E3	-1.026/9.710
0/500°F	-T4	-0.675/12.574	-E4	-1.026/17.945
0/750°F	-T5	-0.675/20.803	-E5	-1.026/28.857
0/1000°F	–	–	-E6	-1.026/40.064

4.1 Troubleshooting Guide

Malfunction or incorrect operation may be caused by:

1. Reversed polarity:

Check the wiring using **Figure 2-2** as a guide. If the temperature of the thermocouple increases while the current magnitude decreases, the problem could be caused by reversed polarity of the:

- a) thermocouple wiring
- b) power supply leads
- c) monitor instrument

4.1 Troubleshooting Guide (continued)

2. Loose or broken wires:

Check each terminal connection for tightness. Move each wire back and forth and note any changes in operation.

3. Too high a load resistance in the output current loop or too low a current rating on the power supply:

a) Measure the total resistance of each device (excluding the transmitter and power supply) in the 20 mA loop, including the resistance of the lead wires.

b) Calculate maximum allowable loop resistance using the formula: Loop Resistance (maximum) = $\frac{V_{\text{supply}} - 8 \text{ V}}{0.020\text{A}}$

0.020A

For example, a 24V power supply would give a maximum loop resistance of: $16 \text{ V} / 0.020\text{A} = 800 \text{ ohms}$.

c) Make sure the power supply is rated for at least 28 mA times the number of transmitters being powered. For example, if the supply is powering five transmitters, the supply should be rated for at least 140mA.

5.1 Specifications

General

Size:

1.40" dia. x 0.93" high
(includes terminal strip)

Weight:

0.53 oz (15g);
0.83 oz (25g) if potted

Ambient Temperature:

-13°F to 185°F
(-25°C to 85°C)

Storage Temperature

-85°F to 257°F
(-65°C to 125°C)

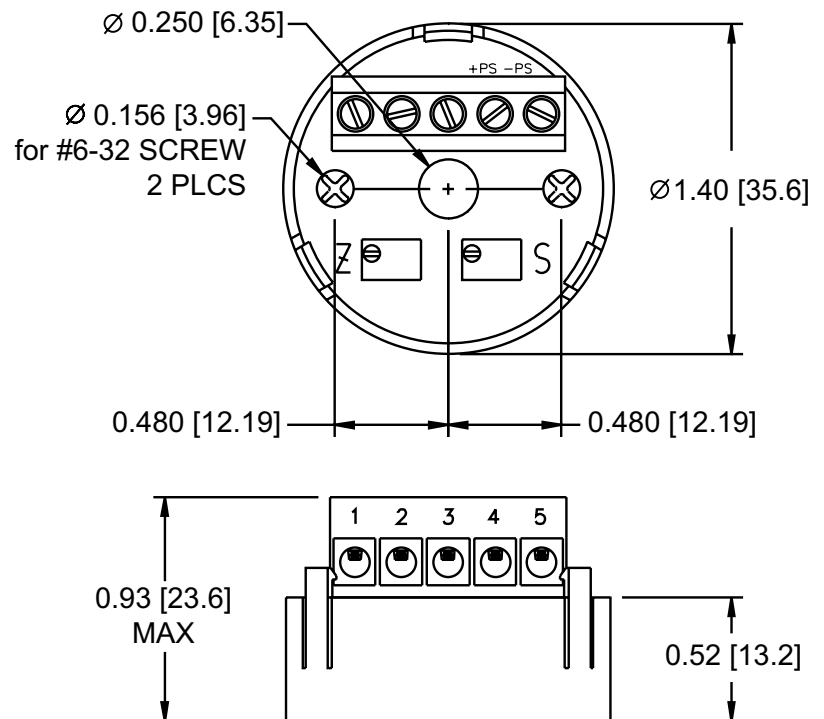

Figure 5-1 Dimensions

5.1 Specifications (continued)

Zero/Span Adj Range:	±25%
Power Supply Voltage	
Operating Range:	+8 Vdc to +35 Vdc, 28 mA max required per transmitter
Accuracy:	±0.1% of full scale (includes effects of hysteresis, repeatability and linearity proportional to the T/C)
Frequency Response:	3dB@ 3Hz
Thermal Zero Shift:	<0.01%/°F of span (span >10 mV) <0.02%/°F of span (4-10 mV span)
Thermal Span Shift:	<0.01%/°F of span

Output

Current Output Span:	4-20 mA dc
Current Output Limits:	3 to 28 mA, typical
Max Loop Resistance:	$(V_{\text{supply}} - 8V)/0.020A = \text{ohms}$
Load Resistance Effect:	0.01% of span per 300 ohms change
Power Supply Effect:	0.002% of output span per volt

Input

Sensor:	Thermocouple
Input Break Protection:	Upscale
Impedance:	>30 M
Source Current:	4 mA typical

Warranty/Disclaimer

NEWPORT Electronics, Inc. warrants this unit to be free of defects in materials and workmanship for a period of one (1) year from the date of purchase. In addition to NEWPORT's standard warranty period, NEWPORT Electronics will extend the warranty period for one (1) additional year if the warranty card enclosed with each instrument is returned to NEWPORT.

If the unit should malfunction, it must be returned to the factory for evaluation. NEWPORT's Customer Service Department will issue an Authorized Return (AR) number immediately upon phone or written request. Upon examination by NEWPORT, if the unit is found to be defective it will be repaired or replaced at no charge. NEWPORT's WARRANTY does not apply to defects resulting from any action of the purchaser, including but not limited to mishandling, improper interfacing, operation outside of design limits, improper repair, or unauthorized modification. This WARRANTY is VOID if the unit shows evidence of having been tampered with or shows evidence of being damaged as a result of excessive corrosion; or current, heat, moisture or vibration; improper specification; misapplication; misuse or other operating conditions outside of NEWPORT's control. Components which wear are not warranted, including but not limited to contact points, fuses, and triacs.

NEWPORT is pleased to offer suggestions on the use of its various products. However, NEWPORT neither assumes responsibility for any omissions or errors nor assumes liability for any damages that result from the use of its products in accordance with information provided by NEWPORT, either verbal or written. NEWPORT warrants only that the parts manufactured by it will be as specified and free of defects. NEWPORT MAKES NO OTHER WARRANTIES OR REPRESENTATIONS OF ANY KIND WHATSOEVER, EXPRESSED OR IMPLIED, EXCEPT THAT OF TITLE, AND ALL IMPLIED WARRANTIES INCLUDING ANY WARRANTY OF MERCHANTABILITY AND FITNESS FOR A PARTICULAR PURPOSE ARE HEREBY DISCLAIMED. LIMITATION OF LIABILITY: The remedies of purchaser set forth herein are exclusive and the total liability of NEWPORT with respect to this order, whether based on contract, warranty, negligence, indemnification, strict liability or otherwise, shall not exceed the purchase price of the component upon which liability is based. In no event shall NEWPORT be liable for consequential, incidental or special damages.

CONDITIONS: Equipment sold by NEWPORT is not intended to be used, nor shall it be used: (1) as a "Basic Component" under 10 CFR 21 (NRC), used in or with any nuclear installation or activity; or (2) in medical applications or used on humans. Should any Product(s) be used in or with any nuclear installation or activity, medical application, or used on humans, or misused in any way, NEWPORT assumes no responsibility as set forth in our basic WARRANTY / DISCLAIMER language, and additionally purchaser will indemnify NEWPORT and hold NEWPORT harmless from any liability or damage whatsoever arising out of the use of the Product(s) in such a manner.

Return Requests/Inquiries

Direct all warranty and repair requests/inquiries to the NEWPORT Customer Service Department. BEFORE RETURNING ANY PRODUCT(S) TO NEWPORT, PURCHASER MUST OBTAIN AN AUTHORIZED RETURN (AR) NUMBER FROM NEWPORT'S CUSTOMER SERVICE DEPARTMENT (IN ORDER TO AVOID PROCESSING DELAYS). The assigned AR number should then be marked on the outside of the return package and on any correspondence.

The purchaser is responsible for shipping charges, freight, insurance and proper packaging to prevent breakage in transit.

FOR **WARRANTY** RETURNS, please have the following information available BEFORE contacting NEWPORT:

1. P.O. number under which the product was PURCHASED,
2. Model and serial number of the product under warranty, and
3. Repair instructions and/or specific problems relative to the product.

FOR **NON-WARRANTY** REPAIRS, consult NEWPORT for current repair charges. Have the following information available BEFORE contacting NEWPORT:

1. P.O. number to cover the COST of the repair,
2. Model and serial number of product, and
3. Repair instructions and/or specific problems relative to the product.

NEWPORT's policy is to make running changes, not model changes, whenever an improvement is possible. This affords our customers the latest in technology and engineering.

NEWPORT is a registered trademark of NEWPORT Electronics, Inc.

© Copyright 2005 NEWPORT Electronics, Inc. All rights reserved. This document may not be copied, photocopied, reproduced, translated, or reduced to any electronic medium or machine-readable form, in whole or in part, without prior written consent of NEWPORT Electronics, Inc.

For immediate technical or application assistance please call:

1-800-6397678®
1-800-NEWPORT

Newport Electronics, Inc.
2229 South Yale Street • Santa Ana, CA • 92704 • U.S.A.
TEL: (714) 540-4914 • FAX: (203) 968-7311
Toll Free: 1-800-639-7678 • www.newportUS.com • e-mail: info@newportUS.com
ISO 9001 Certified

Newport Technologies, Inc.
976 Bergar • Laval (Quebec) • H7L 5A1 • Canada
TEL: (514) 335-3183 • FAX: (514) 856-6886
Toll Free: 1-800-639-7678 • www.newport.ca • e-mail: info@newport.ca

Newport Electronics, Ltd.
One Omega Drive • River Bend Technology Centre
Northbank, Irlam • Manchester M44 5BD • United Kingdom
Tel: +44 161 777 6611 • FAX: +44 161 777 6622
Toll Free: 0800 488 488 • www.newportuk.co.uk • e-mail: sales@newportuk.co.uk

Newport Electronics B.V.
Postbus 8034 • 1180 LA Amstelveen • The Netherlands
TEL: +31 20 3472121 • FAX: +31 20 6434643
Toll Free: 0800 0993344 • www.newport.nl • e-mail: info@newport.nl

Newport Electronics spol s.r.o.
Frystatska 184, 733 01 Karviná • Czech Republic
TEL: +420 59 6311899 • FAX: +420 59 6311114
Toll Free: 0800-1-66342 • www.newport.cz • e-mail: info@newport.cz

Newport Electronics GmbH
Daimlerstrasse 26 • D-75392 Deckenpfronn • Germany
TEL: 49 7056 9398-0 • FAX: 49 7056 9398-29
Toll Free: 0800 / 6397678 • www.newport.de • e-mail: sales@newport.de

Newport Electronique S.A.R.L.
11, rue Jacques Cartier • 78280 Guyancourt • France
TEL: +33 1 61 37 29 00 • FAX: +33 1 30 57 54 27
Toll Free: 0800 466 342 • www.newport.fr • e-mail: sales@newport.fr

Mexico and Latin America
FAX: 001 (203) 359-7807
En Español: 001 (203) 359-7803

NEWPORTnetSM On-Line Service www.newportUS.com
--

Internet e-mail info@newportUS.com
--

 **NEWPORT** Electronics, Inc.

M4123/N/1005