

SNAP PAC Motion Control Subsystem

Features

- Extensive programmability and PC functionality at the I/O level
- Support for multiple processes, high-speed compiled code, and diverse programming languages
- Connection accessories provided
- Works with SNAP PAC R-series controllers and SNAP PAC EB-series brains
- Up to eight serial modules per rack
- Compact and rugged units suitable for deployment in harsh environments

Description

The easy-to-use SNAP PAC Motion Control Subsystem provides an integrated hardware and software toolset for controlling multi-axis stepper motors. The subsystem consists of:

- SNAP Motion Control host communication modules (SNAP-SCM-MCH16)
- SNAP Motion Control breakout boards (SNAP-SCM-BB4)
- OptoMotion command set.

The **SNAP-SCM-MCH16** motion control host module is a serial communication module that links up to four SNAP-SCM-BB4 motion control breakout boards with a SNAP PAC I/O unit. When mounted on an I/O unit and connected to a breakout board, a single SNAP-SCM-MCH16 module allows a SNAP PAC controller running a PAC Control™ programming strategy to control up to 16 stepper motors. The module snaps into an Opto 22 SNAP PAC mounting rack right beside digital and analog modules. LED indicators are provided to indicate Transmit and Receive on each port.

Each **SNAP-SCM-BB4** breakout board is equipped with a Magellan™ processor chip set that outputs pulse and direction signals for up to four stepper motor systems. You can daisy-chain up to four breakout boards connected to a single module. The module's external connector provides lines to power one breakout board; additional boards require a separate power source. The SNAP-SCM-BB4 breakout board is designed to be mounted using a DIN-rail system.

The **OptoMotion** commands supports many of the Magellan™ Motion Processor commands. These commands are entered in a PAC Control strategy as text strings using the Transmit String and Receive commands or the TransmitReceiveString command in OptoScript. The OptoMotion commands give you the ability to define and



acquire motion process data such as position, velocity, acceleration, breakpoints, interrupts, and time intervals. In addition, you can execute motion-related actions such as smooth stops, stepping, and position adjustments.

Calculating Power Requirements

When you assemble a SNAP rack that includes a SNAP-SCM-MCH16, you need to calculate the power requirements to make sure that the rack's power supply is adequate for the combined current needed by the brain or controller and all the I/O modules. For more information and power requirements worksheets, see the *SNAP I/O Wiring Guide* (form #1403) as well as the wiring appendices in the *SNAP PAC Brain User's Guide* (form #1690) and the *SNAP PAC R-Series Controller User's Guide* (form #1595).

Powering the Breakout Board

When using power from the SNAP-SCM-MCH16 module, you can use only one breakout board. The breakout board should be connected with a cable under two meters long, and the stepper logic must be isolated from the drive output. If you are uncertain how to achieve this, consider using an auxilliary power supply instead.

When using an auxilliary power supply, you can choose either the 5 VDC auxilliary input or the 8 to 32 VDC auxilliary input on the breakout board.

Part Numbers

Part	Description
SNAP-SCM-MCH16	Single channel RS-422 (four wire) motion control communication module
SNAP-SCM-BB4	SNAP Motion Control Breakout Board, 4 axes, Stepper
SNAP-RACKDIN	SNAP rack DIN-rail adapter clip
SNAP-RACKDINB	SNAP rack DIN-rail adapter clip, 25-pack

SNAP PAC Motion Control Subsystem

Module Specifications

Baud rates	115,200
Parity	Even
Data bits	8 only
Logic supply voltage	5.0 to 5.2 VDC
Logic supply current	250 mA ¹ 500 mA ²
Number of ports per module	1
Maximum number of modules per rack	8 ¹
Maximum cable length, multi-drop	1,000 feet at 115,200 Baud
I/O processor (brain or on-the-rack controller) compatibility	SNAP-PAC-R1, SNAP-PAC-R2, SNAP-PAC-EB1, or SNAP-PAC-EB2
Operating temperature	0 to 70 °C
Storage temperature	-30 to 85 °C
Torque, hold-down screws	4 in-lb (0.45 N-m)
Torque, connector screws	5.26 in-lb (0.6 N-m)
Agency Approvals	CE, RoHS, DFARS
Warranty	30 months

1. Each breakout board is powered by a separate power supply.
2. Breakout board uses power from the module.

Module LEDs

LED	Indicates
1	Program LED
2	TX
3	Power Supply Fault
4	RX

Breakout Board Specifications

Power Requirements	8.0 to 32.0 VDC @ 250mA 5.00 to 5.20 VDC @ 500mA
Operating Temperature	0 to 70 °C
Relative Humidity	95%, non-condensing
Agency Approvals	CE, RoHS, DFARS
Warranty	30 months

Breakout Board LEDs

Power and Serial LEDs

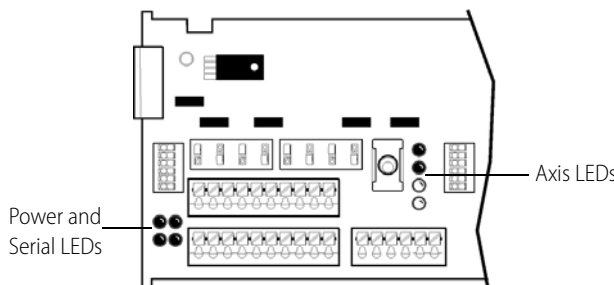
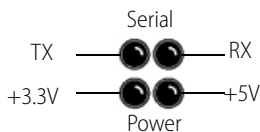

Axis LEDs

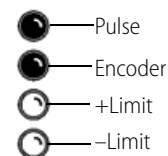

SNAP PAC Motion Control Subsystem

Dimensional Drawings

SNAP-SCM-MCH16 Motion Control Module

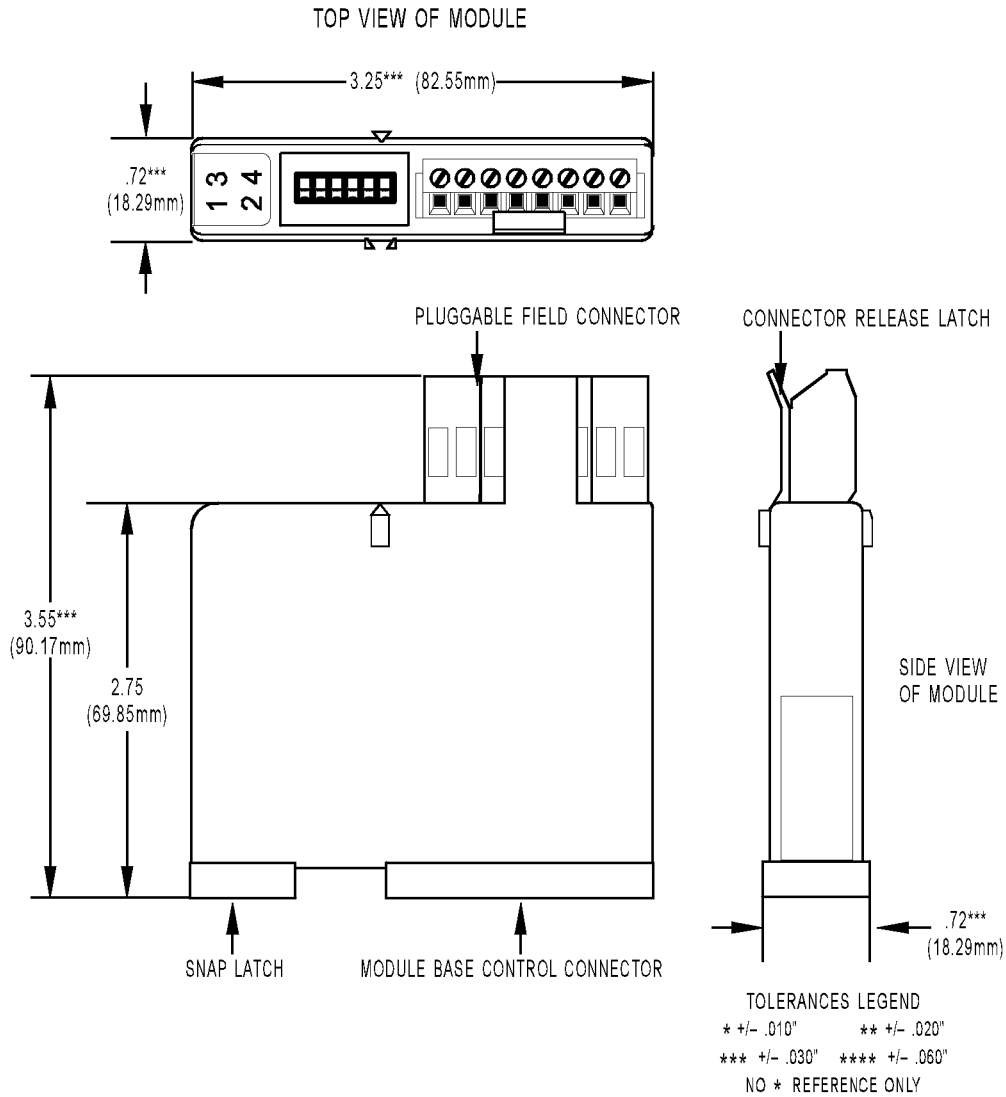

SNAP PAC Motion Control Subsystem

Dimensional Drawings (cont)

SNAP-SCM-BB4 Breakout Board

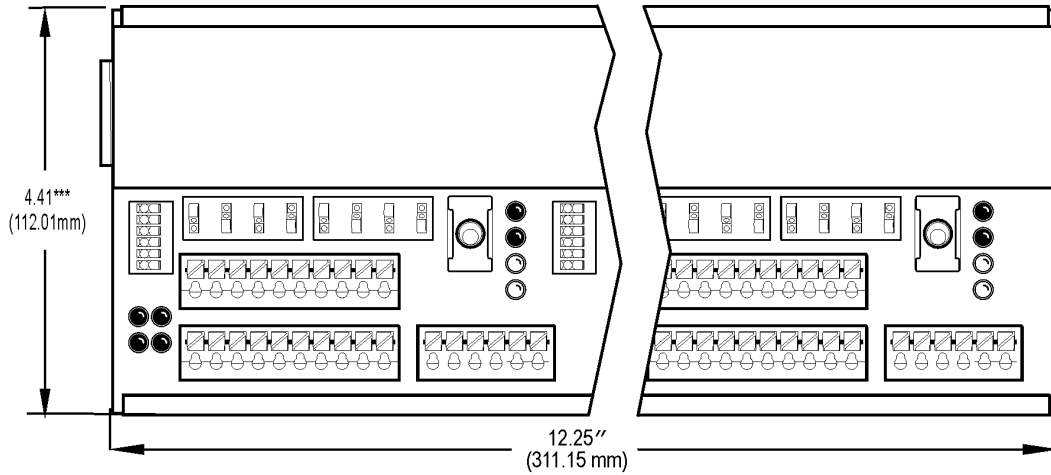

TOLERANCE LEGEND
 * +/- .010"
 ** +/- .020"
 *** +/- .030"
 **** +/- .060"
 NO * REFERENCE ONLY

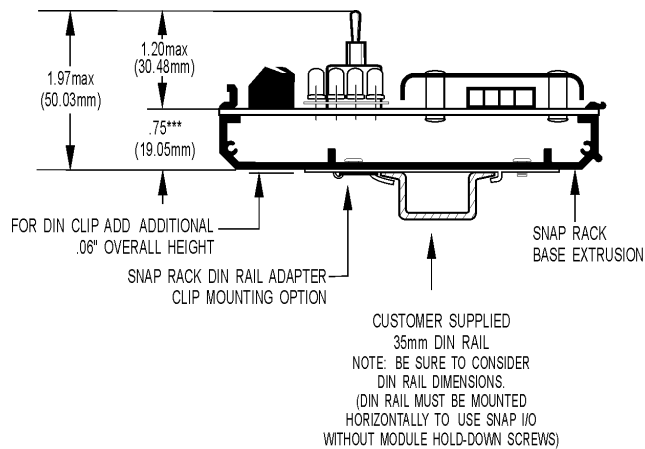

TOLERANCE LEGEND
 * +/- .010"
 ** +/- .020"
 *** +/- .030"
 **** +/- .060"
 NO * REFERENCE ONLY

SNAP PAC Motion Control Subsystem

SNAP SCM Motion Control Communication Diagram

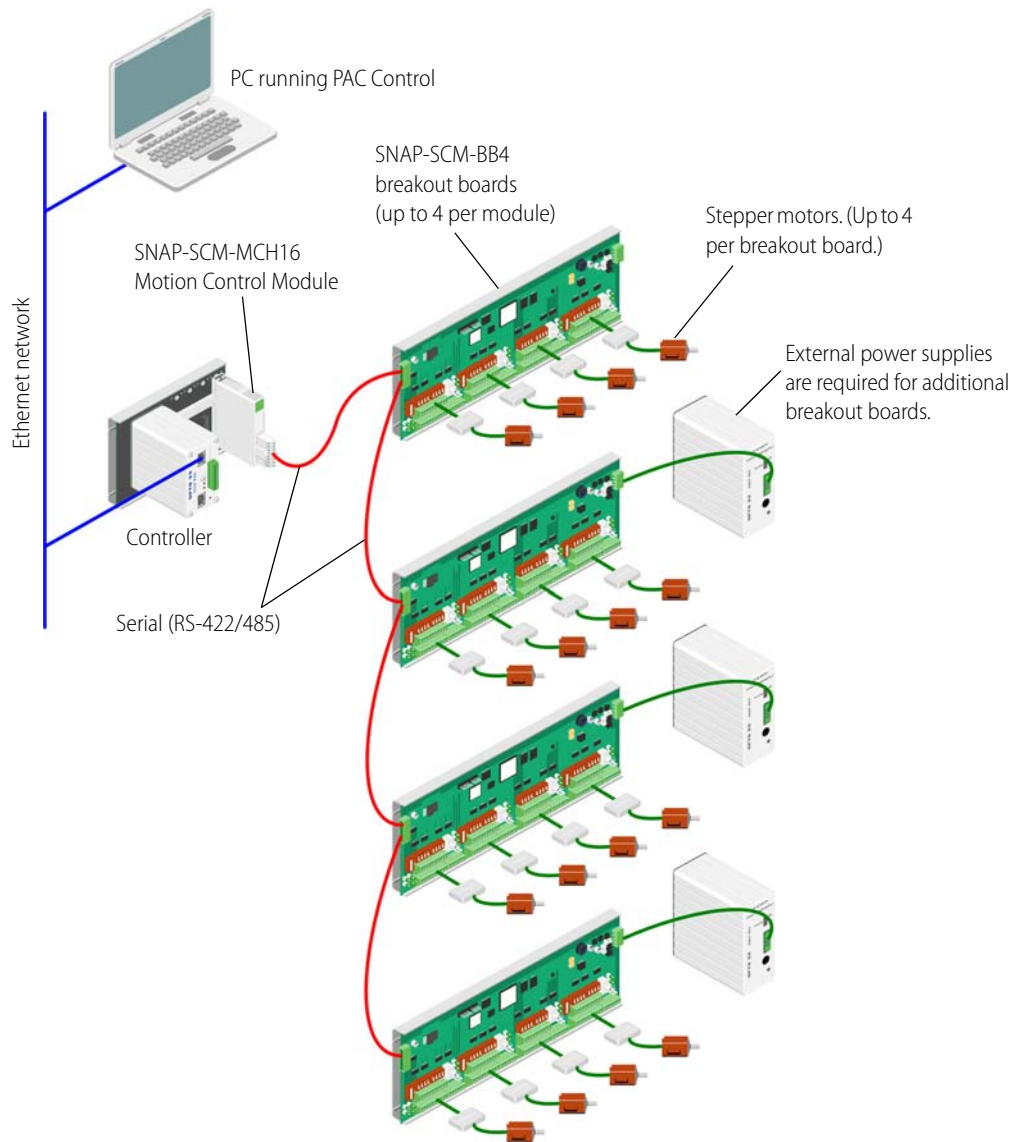

SNAP PAC Motion Control Subsystem

SCM-Motion Communication Diagrams (cont.)

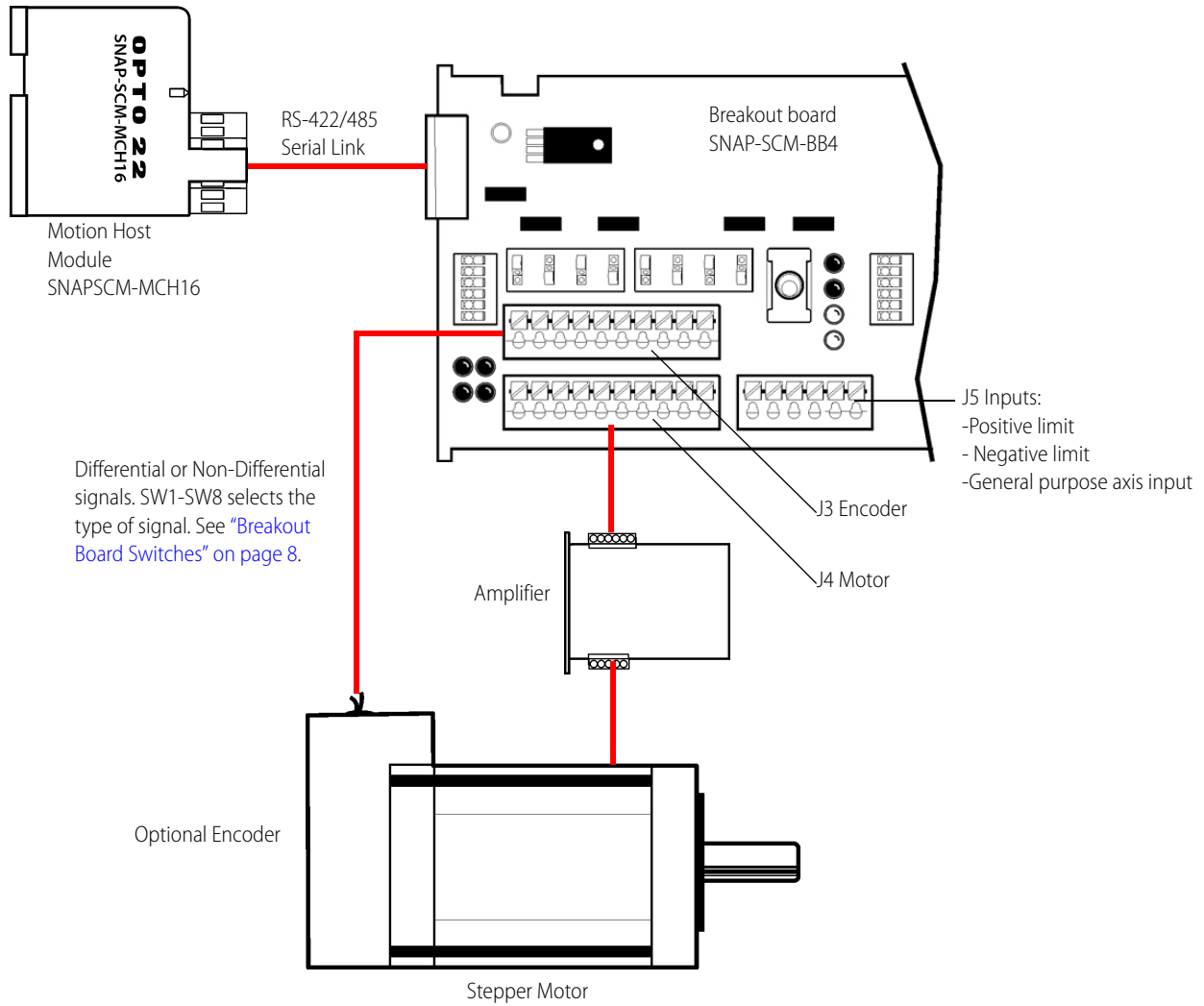

SNAP PAC Motion Control Subsystem

Breakout Board Connector Pins

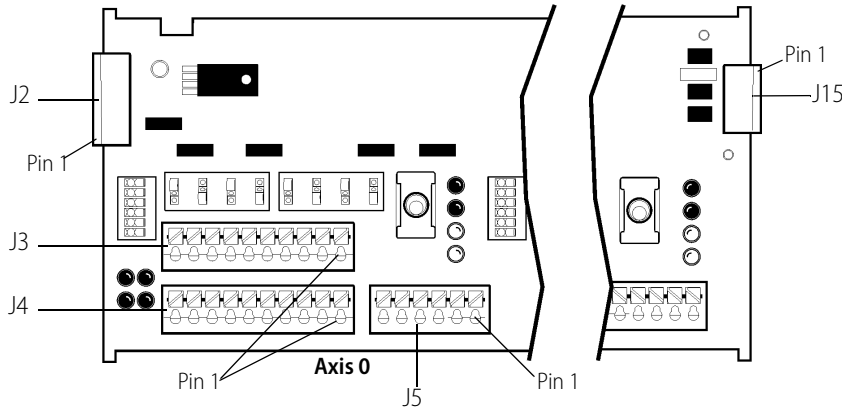

J15: Auxiliary Power Input

Pin	Description
1	Aux +5Vin
2	Aux +8-24vin
3	GND
4	Chassis GND

J2: Serial Connector

Pin	Description
1	ToHost+
2	ToHost-
3	GND
4	FromHost+
5	FromHost-
6	Chassis GND
7	Vmod
8	VMod
9	GND
10	GND

J4 (and J7, J10, & J13): Stepper Motor Outputs

Pin	Description
1	Pulse+
2	Pulse-
3	GND
4	Direction+
5	Direction-
6	AtRest+
7	AtRest-
8	GND
9	AxisOut+
10	AxisOut-

J3 (and J6, J9, & J12): Encoder Signal Inputs

Pin	Description
1	QuadA+
2	QuadA-
3	GND
4	QuadB+
5	QuadB-
6	Index+
7	Index-
8	GND
9	Home+
10	Home-

J5 (and J8, J11, & J14): Stepper Motor Inputs

Pin	Description
1	PosLimit
2	GND
3	NegLimit
4	GND
5	AxisIn
6	GND

SNAP PAC Motion Control Subsystem

Breakout Board Switches

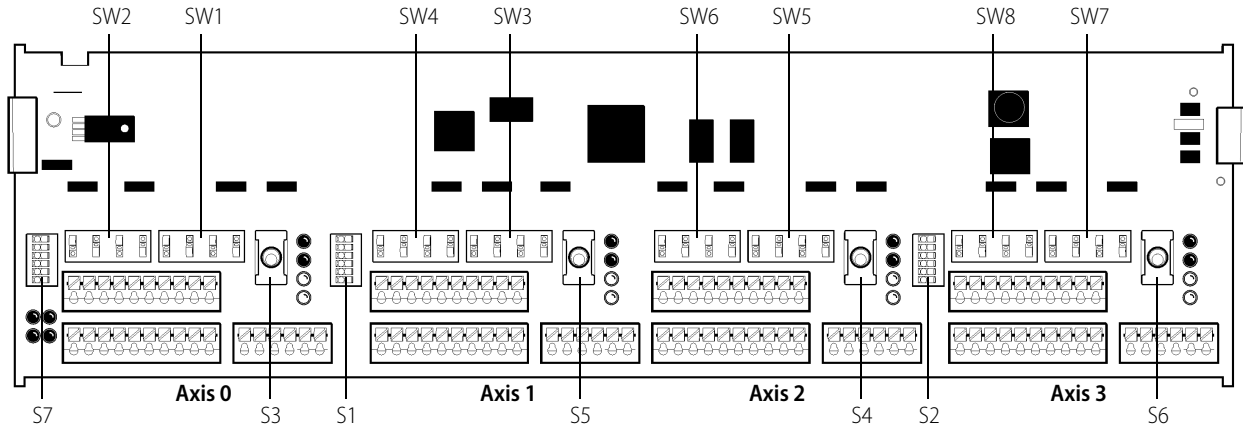

SW1 - SW8: Signal Selection for Encoder Inputs

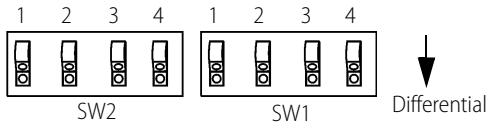

All up=Non-differential
All down=Differential

Position	Description
SW1 (and SW3, SW5, & SW7)	
1 & 2	QuadA
3 & 4	QuadB
SW2 (and SW4, SW6, & SW8)	
1 & 2	Index
3 & 4	Home

S1 & S2: Pullup Resistors

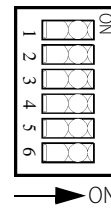

Switch	Axis	Description
S1: J5 & J8 Pull Ups		
1	0	PosLimit)
2	0	NegLimit
3	0	AxisIn
4	1	PosLimit
5	1	NegLimit
6	1	AxisIn
S2: J11 & J14 Pull Ups		
1	2	PosLimit
2	2	NegLimit
3	2	AxisIn
4	3	PosLimit
5	3	NegLimit
6	3	AxisIn

See also, "If Pull-Up Resistors Are Not Used" on page 9.

S3 (and S5, S4, & S6): Enable/Disable Axis

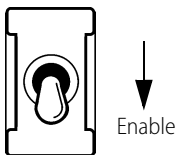

Position	Enable/Disable
Up	Disable
Middle	Disable
Down	Enable

S7: Bias & Termination, Voltage Select, Breakout Board Address

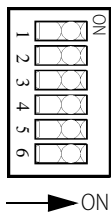

Switch	Description
1	ToHost Termination
2	FromHost Termination
3	Aux +8-24Vin Select
4	Aux +8-24Vin Select
5	ADDR0
6	ADDR1

SNAP PAC Motion Control Subsystem

If Pull-Up Resistors Are Not Used

If pull-up resistors are not used, the inputs shown on page 8 (see "S1 & S2: Pullup Resistors") will be floating and could cause unexpected behavior if not driven by an external source.

If driven to +5v, the Limit inputs will be asserted. If driven to GND, the Limit inputs will be de-asserted. See circuit below. If you wish to invert this logic, see the [SetSignalSense](#) command. If you wish to disable the limit inputs, see the [SetLimitSwitchMode](#) command on page 94.

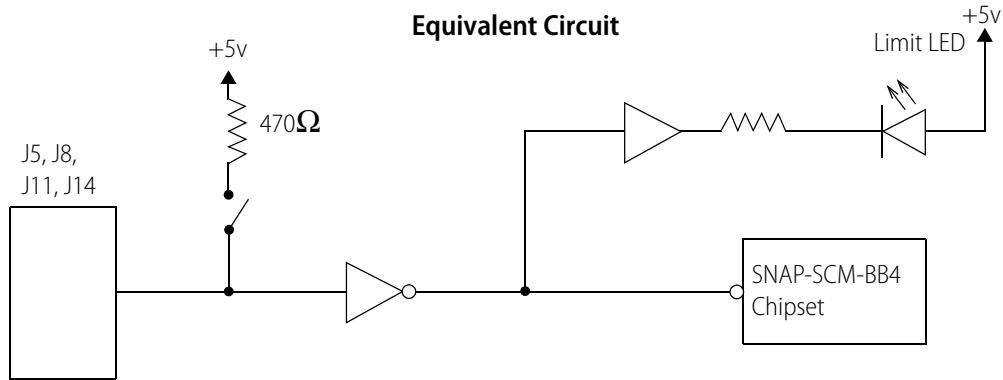

SNAP PAC Motion Control Subsystem

Commands

The following Magellan™ Motion Processor commands are supported in PAC Control using OptoScript. In order for the SNAP-SCM-MCH16 module to convert these commands to binary for the motion processor on the breakout board, the

module must be in command mode. For information on command mode and using these commands in PAC Control, see the *SNAP PAC Motion Control Subsystem User's Guide* (form #1673).

Commands	Description
Breakpoints and Interrupts	
ClearInterrupt	Reset interrupt line.
Set/GetBreakPoint	Set/Get breakpoint type.
Set/GetBreakPointValue	Set/Get breakpoint comparison value.
GetInterruptAxis	Get the axes with pending interrupts.
Set/GetInterruptMask	Set/Get interrupt mask.
Digital Servo Filter	
ClearPositionError	Set position error to 0.
Set/GetAutoStopMode	Set/Get auto stop on position error (on or off).
GetPositionError	Get the position error.
Set/GetPositionErrorLimit	Set/Get the maximum position error limit.
Encoder	
AdjustActualPosition	Sums the specified offset with the actual encoder position.
Set/GetActualPosition	Set/Get the actual encoder position.
Set/GetActualPositionUnits	Set/Get the unit type returned for the actual encoder position.
GetActualVelocity	Get the actual encoder velocity.
Set/GetCaptureSource	Set/Get the capture source (home or index).
GetCaptureValue	Get the position capture value, and reset the capture.
Set/GetEncoderModulus	Set/Get the full scale range of the parallel-word encoder
Set/GetEncoderSource	Set/Get the encoder type.
Set/GetEncoderToStepRatio	Set/Get encoder count to step ratio.
External RAM	
Set/GetBufferLength	Set/Get the length of a memory buffer.
Set/GetBufferReadIndex	Set/Get the buffer read pointer for a particular buffer.
Set/GetBufferStart	Set/Get the start location of a memory buffer.
Set/GetBufferWriteIndex	Set/Get the buffer write pointer for a particular buffer.
ReadBuffer	Read a long word value from a buffer memory locations.
WriteBuffer	Write a long word value to a buffer memory location.
Motor Output	
Set/GetMotorMode	Set/Get motor loop mode.
Set/GetMotorType	Set/Get motor type for axis.
Set/GetStepRange	Set/Get the allowable range (in kHz) for step output generation.
Profile Generation	
Set/GetAcceleration	Set/Get acceleration limit.
GetCommandedAcceleration	Get commanded (instantaneous desired) acceleration
GetCommandedPosition	Get commanded (instantaneous desired) position.

SNAP PAC Motion Control Subsystem

Commands	Description
GetCommandedVelocity	Get commanded (instantaneous desired) velocity.
Set/GetDeceleration	Set/Get deceleration limit.
Set/GetGearMaster	Set/Get the electronic gear mode master axis and source (actual or target-based).
Set/GetGearRatio	Set/Get commanded electronic gear ratio.
Set/GetJerk	Set/Get jerk limit.
Set/GetPosition	Set/Get the destination position.
Set/GetProfileMode	Set/Get the profile mode (S-curve, trapezoidal, velocity-contouring, or electronic gear).
Set/GetStartVelocity	Set/Get start velocity.
Set/GetStopeMode	Set/Get stop command; abrupt, smooth, or none.
Set/GetVelocity	Set/Get velocity limit.
MultiUpdate	Forces buffered command values to become active for multiple axes.
Update	Forces buffered command values to become active.
ServoLoopControl	
Set/GetAxisMode	Set/Get the axis operation mode (enabled or disabled).
Set/GetLimitSwitchMode	Set/Get the limit switch mode (on or off).
Set/GetMotionCompleteMode	Set/Get the motion complete mode (target-based or actual).
Set/GetSampleTime	Set/Get servo loop sample time.
Set/GetSettleTime	Set/Get the axis-settled time.
Set/GetSettleWindow	Set/Get the settle-window boundary value.
GetTime	Get current chip set time (number of servo loops).
Set/GetTrackingWindow	Set/Get the tracking window boundary value.
Status Registers and AxisOut Indicator	
GetActivityStatus	Get activity status register.
Set/GetAxisOutSource	Set/Get axis out signal monitor source.
GetEventStatus	Get event status register.
GetSignalStatus	Get the signal status register.
Set/GetSignalSense	Set/Get the interpretation of the signal status bits.

More About Opto 22

Products

Opto 22 develops and manufactures reliable, flexible, easy-to-use hardware and software products for industrial automation, remote monitoring, and data acquisition applications.

SNAP PAC System

Designed to simplify the typically complex process of understanding, selecting, buying, and applying an automation system, the SNAP PAC System consists of four integrated components:

- SNAP PAC controllers
- PAC Project™ Software Suite
- SNAP PAC brains
- SNAP I/O™

SNAP PAC Controllers

Programmable automation controllers (PACs) are multifunctional, multidomain, modular controllers based on open standards and providing an integrated development environment.

Opto 22 has been manufacturing PACs for many years. The latest models include the standalone SNAP PAC S-series and the rack-mounted SNAP PAC R-series. Both handle a wide range of digital, analog, and serial functions and are equally suited to data collection, remote monitoring, process control, and discrete and hybrid manufacturing.

SNAP PACs are based on open Ethernet and Internet Protocol (IP) standards, so you can build or extend a system without the expense and limitations of proprietary networks and protocols.

PAC Project Software Suite

Opto 22's PAC Project Software Suite provides full-featured and cost-effective control programming, HMI (human machine interface) development and runtime, OPC server, and database connectivity software to power your SNAP PAC System.

These fully integrated software applications share a single tagname database, so the data points you configure in PAC Control™ are immediately available for use in PAC Display™, OptoOPCServer™, and OptoDataLink™. Commands are in plain English; variables and I/O point names are fully descriptive.

PAC Project Basic offers control and HMI tools and is free for download on our website, www.opto22.com. PAC Project Professional, available for separate purchase, adds OptoOPCServer, OptoDataLink, options for Ethernet link redundancy or segmented networking, and support for legacy Opto 22 serial *mistic*™ I/O units.

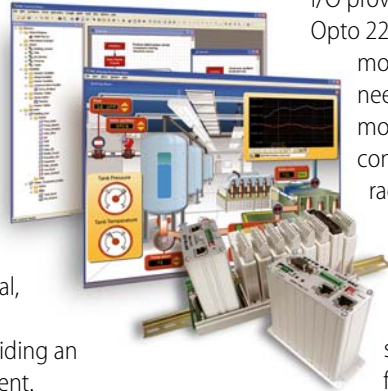

SNAP PAC Brains

While SNAP PAC controllers provide central control and data distribution, SNAP PAC brains provide distributed intelligence for I/O processing and communications. Brains offer analog, digital, and serial functions, including thermocouple linearization; PID loop control; and optional high-speed digital counting (up to 20 kHz), quadrature counting, TPO, and pulse generation and measurement.

SNAP I/O

I/O provides the local connection to sensors and equipment. Opto 22 SNAP I/O offers 1 to 32 points of reliable I/O per module, depending on the type of module and your needs. Analog, digital, serial, and special-purpose modules are all mixed on the same mounting rack and controlled by the same processor (SNAP PAC brain or rack-mounted controller).

Quality

Founded in 1974 and with over 85 million devices sold, Opto 22 has established a worldwide reputation for high-quality products. All are made in the U.S.A. at our manufacturing facility in Temecula, California. Because we do no statistical testing and each part is tested twice before leaving our factory, we can guarantee most solid-state relays and optically isolated I/O modules for life.

Free Product Support

Opto 22's Product Support Group offers free, comprehensive technical support for Opto 22 products. Our staff of support engineers represents decades of training and experience. Product support is available in English and Spanish, by phone or email, Monday through Friday, 7 a.m. to 5 p.m. PST.

Free Customer Training

Hands-on training classes for the SNAP PAC System are offered at our headquarters in Temecula, California. Each student has his or her own learning station; classes are limited to nine students. Registration for the free training class is on a first-come, first-served basis. See our website, www.opto22.com, for more information or email training@opto22.com.

Purchasing Opto 22 Products

Opto 22 products are sold directly and through a worldwide network of distributors, partners, and system integrators. For more information, contact Opto 22 headquarters at 800-321-6786 or 951-695-3000, or visit our website at www.opto22.com.

www.opto22.com