

SNAP PAC R-Series

Features

- Rack-mounted industrial controller with I/O processor included.
- Two independent 10/100 Mbps Ethernet network interfaces
- Wired+Wireless models add wireless LAN network interface as well
- One RS-232 port with handshaking, suitable for modem communication using PPP
- MicroSD card slot for removable data storage
- Full-featured control and HMI software included with purchase

Description

The affordable and compact SNAP PAC R-series programmable automation controllers provide powerful, real-time control and communication to meet your industrial control, monitoring, and data acquisition needs. Part of the Opto 22 SNAP PAC System™, the R-series PAC is a rack-mounted, industrially hardened unit that can handle multiple tasks involving digital and analog control, serial string handling, communication, and enterprise connectivity.

Used with the included PAC Project Basic software suite (or PAC Project Professional, purchased separately), the Ethernet-based SNAP PAC R-series controller runs control programs written in Opto 22's PAC Control™ software. It can monitor and control a wide range of devices and equipment wired to the I/O on its own rack and to I/O on distributed racks equipped with SNAP PAC EB-series brains. Alternatively, the R-series controller can be used as a slave to a larger, SNAP PAC S-series standalone industrial controller.

SNAP PAC R-series controllers are well suited to original equipment manufacturers (OEMs), system integrators, and end-users in process control, discrete manufacturing, or hybrid industries and applications.

Six models of the SNAP PAC R-series controller are available:

- **SNAP-PAC-R1, SNAP-PAC-R1-FM, and SNAP-PAC-R1-W** each control a mix of SNAP analog, digital (both standard and high-density), and serial modules. Full digital functions include high-speed counting, quadrature counting, pulse measurement, and period and frequency measurement. The -FM model is Factory Mutual approved. The -W model adds wireless LAN capability (see [“Wired+Wireless Communication”](#) on [page 2](#) for more information).



SNAP-PAC-R1 controller

- **SNAP-PAC-R2, SNAP-PAC-R2-FM, and SNAP-PAC-R2-W** also control a mix of SNAP analog, standard and high-density digital, and serial modules. High-speed digital functions are not included. The -FM model is Factory Mutual approved. The -W model adds wireless LAN capability (see [page 2](#) for more information).

Built-in functions and comparisons of the SNAP-PAC-R1 and SNAP-PAC-R2 are shown in the table on [page 9](#).

Part Numbers

Part	Description
SNAP-PAC-R1	Analog/digital/serial rack-mounted controller with two Ethernet ports and high-speed digital functions
SNAP-PAC-R2	Analog/simple digital/serial rack-mounted controller with two Ethernet ports
SNAP-PAC-R1-FM	Analog/digital/serial rack-mounted controller with two Ethernet ports and high-speed digital functions, Factory Mutual approved
SNAP-PAC-R2-FM	Analog/simple digital/serial rack-mounted controller with two Ethernet ports, Factory Mutual approved
SNAP-PAC-R1-W	Wired+Wireless analog/digital/serial rack-mounted controller with two wired Ethernet ports, one wireless Ethernet interface, and high-speed digital functions
SNAP-PAC-R2-W	Wired+Wireless analog/simple digital/serial rack-mounted controller with two wired Ethernet ports and one wireless Ethernet interface

Ethernet Communication

All SNAP PAC R-series controllers communicate over standard 10/100 Mbps Ethernet networks and can be attached to an existing network. The controllers can also be used in an independent control network built with standard, off-the-shelf Ethernet hardware.

SNAP PAC R-series controllers include two 10/100 Mbps Ethernet interfaces for networking to Ethernet hosts and to other I/O units. These independent Ethernet ports have separate IP addresses that can be used with PAC Project™ Professional software to set up redundant network links to safeguard the availability and reliability of an I/O system, or to segment a control system's network from the enterprise LAN.

Supported protocols over Ethernet include EtherNet™/IP, Modbus®/TCP, SMTP, SNMP, FTP, and OptoMMP.

Wired+Wireless Communication

SNAP-PAC-R1-W and **SNAP-PAC-R2-W** controllers add wireless capability to communications. In addition to the two wired network interfaces, these models have a wireless network interface as well, so each PAC has a total of three separate IP addresses—two wired and one wireless. Wired+Wireless PACs can be used wirelessly or on a wired network, or both at once.

For flexibility in designing your wireless network, wireless communication includes support for 802.11a, b, and g standards. Wired+Wireless PACs can be used with a variety of wireless switches and other infrastructure hardware. For the best security, the 802.11i WPA2/AES standard is supported, while older WPA and WEP security standards are included for backwards compatibility.

Because wireless functionality is in the PAC itself, no additional parts are required within the control system for wireless use. All SNAP PAC racks and SNAP I/O modules can be used either wired or wirelessly. You can switch from one network to the other without reconfiguring I/O or changing field wiring.

Just like a laptop computer with a wireless connection, all functionality remains the same whether the Wired+Wireless PAC is used wirelessly or as part of a wired network. Supported protocols remain the same. And control



SNAP-PAC-R1-W

SNAP PAC R-Series Controllers

programs run the same on both networks without reprogramming.

Serial Communication

SNAP PAC R-series controllers provide an RS-232 serial link to support Point-to-Point Protocol (PPP) modem connections—for creating TCP/IP networks over serial or PSTN (Public Switched Telephone Network) lines—as well as remote serial device communication.

The RS-232 serial interface supports either a modem connection using PPP or general-purpose communication with serial devices, allowing you to send and receive data from a serial device connected directly to the controller. For additional serial interfaces, you can add one or more SNAP serial communication modules on the rack.

NOTE: The R-series controller does not include an RS-485 port and cannot be used to control Opto 22 serial I/O processors, such as the SNAP PAC SB-series brains. Use an S-series controller for serial brains.

I/O Mounting Racks

SNAP PAC R-series controllers must be connected to the appropriate rack to avoid damage to the controller. Both the SNAP-PAC-R1 and R2 are designed to work with SNAP PAC mounting racks, which are available with 4, 8, 12, or 16 positions for Opto 22 SNAP I/O modules. Part numbers are SNAP-PAC-RCK4, SNAP-PAC-RCK8, SNAP-PAC-RCK12, and SNAP-PAC-RCK16. Factory Mutual-approved versions of these racks, with part numbers ending in -FM, are also available.

SNAP I/O

The SNAP PAC R-series controllers support all SNAP I/O modules available on our website. SNAP digital I/O modules contain four input or output points, and SNAP high-density digital modules contain 16 or 32 input or output points. SNAP analog modules contain 2 to 32 points, depending on the module.

Software

SNAP PAC controllers use Opto 22's **PAC Project** Microsoft® Windows®-compatible automation software for programming, human-machine-interface (HMI) development, and OPC connectivity.

SNAP PAC R-Series Controllers

Two versions of PAC Project are available:

- **PAC Project Basic** includes PAC Control™ for developing control programs, PAC Display™ for creating operator interfaces, and PAC Manager™ configuration software.
- **PAC Project Professional** adds expanded versions of PAC Control and PAC Display plus OptoOPCServer™ software for exchanging data with OPC 2.0-compliant client software applications and OptoDataLink™ for exchanging SNAP PAC System data with databases (including Microsoft SQL Server, Microsoft Access, and MySQL), text files, and email systems).

PAC Control Basic is a graphical, flowchart-based programming tool for machine control and process

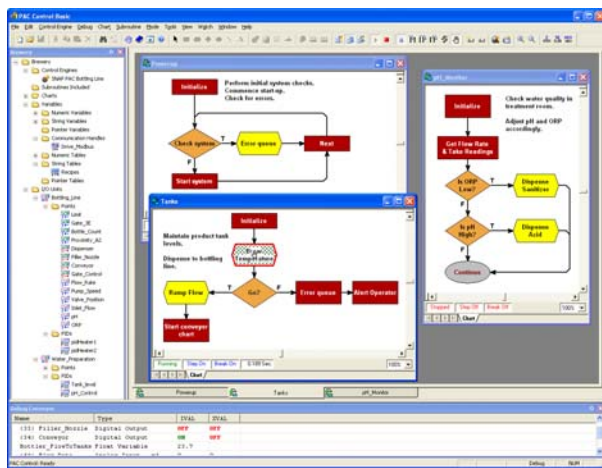

applications. Using PAC Control, you create, download, and run strategies on a SNAP PAC controller. In addition to flowchart programming with subroutine capability, PAC Control includes a powerful, built-in scripting language based on C and other procedural languages. **PAC Control Professional** adds the ability to import legacy OptoControl strategies, support for older *mistic*™ serial I/O units, and support for the dual independent Ethernet ports on a SNAP PAC controller. A SNAP R-series controller simultaneously runs up to 16 PAC Control flowcharts, although the PAC Control strategy can actually contain a much larger number of flowcharts. The total number of flowcharts is limited only by the memory available for strategy storage.

PAC Display Basic is an intuitive HMI package for building operator interfaces, or *projects*, for communicating with a SNAP PAC controller. PAC Display offers a full-featured HMI including alarming, trending, and a built-in library of 3,000 industrial automation graphics. **PAC Display Professional** adds the ability to import projects created in OptoDisplay, part of the legacy Opto 22 FactoryFloor® software suite, and using

redundant Ethernet communication links on SNAP PAC controllers. PAC Display Professional can also connect to Ethernet-based FactoryFloor controllers running OptoControl strategies.

OptoOPCServer is a fast, efficient OPC 2.0-compliant server for communicating with many Opto 22 products, including SNAP PAC controllers and I/O units, plus legacy Opto 22 Ethernet-based controllers and I/O. Using OptoOPCServer, you can consolidate data from all these Opto 22 systems into the OPC client software of your choice, such as third-party HMI and data acquisition packages, and custom software applications you create with tools such as Visual C++®.

OptoDataLink is a software application that makes it easy to share data from the SNAP PAC System with commonly used databases, including Microsoft SQL Server, Microsoft Access, and MySQL, as well as text files. The I/O points and strategy variables already created in your PAC Control strategy are automatically available for OptoDataLink to use for data exchange.

PAC Manager is a utility application for assigning IP addresses to SNAP PAC controllers and brains, reading or changing basic controller configuration, and configuring and testing I/O.

Software Availability

PAC Project Basic is included with SNAP PAC controllers and is a free download from the Opto 22 website.

PAC Project Professional is available for purchase on our website. To get it immediately, you can buy and download the software from the Opto 22 website at www.opto22.com; the CD and printed documentation will be shipped to you. You can also separately purchase PAC Control Professional, PAC Display Professional, OptoOPCServer, and OptoDataLink as needed.



SNAP PAC R-Series Controllers

Specifications

Specifications are continued on the following page.

Processor	200 MHz 32-bit ColdFire® 5475 with integrated floating-point unit (FPU)
Memory Total RAM	Wired+Wireless models 32 MB; other models 16 MB (All models: 4 MB available for PAC Control strategy; 2 MB for file storage)
Battery-backed RAM Flash	2 MB (1 MB available for PAC Control strategy) 8 MB (3.25 MB available for PAC Control strategy; 384 KB available for file storage)
Removable storage	(Models manufactured November 2008 and later; requires firmware R8.4 or higher) MicroSD card slot: supports MicroSD card up to 2 GB maximum
Backup battery	Rechargeable (recharges whenever the brain has power), 3-year power-off data retention ¹
Communication (wired) Ethernet	Two independent 10/100 Mbps Ethernet network interfaces (RJ-45 connectors) Each interface has a separate IP address. Connects to host and I/O.
RS-232 serial	One RS-232 serial port ² with hardware handshaking. Connects to host (via modem and PPP) or serial device. Cannot connect to serial I/O.
Communication (wireless) ³ Topologies Security	Wireless LAN interface with separate IP address. Infrastructure, Ad-Hoc 802.11i: AES - Compatible with WPA2 Personal, TKIP - Compatible with WPA Personal, WEP. Note: TKIP/AES security is not supported in Ad-Hoc mode.
Frequency 802.11a	5.180–5.240 GHz, 5.745–5.825 GHz
Frequency 802.11b/g	2.412–2.472 GHz, 2.484 GHz
Transmit Power	15 dBm maximum
Antenna Connector	Reverse polarity SMA (RP-SMA or RSMA)
Roaming	Supported within an SSID (Service Set Identifier) only
I/O unit compatibility	SNAP PAC I/O units: SNAP PAC R-series and EB-series I/O units
Power requirements	5.0–5.2 VDC @ 1.5 A
Hold-down screw	Torque: 8 in-lb (0.9 N-m)
Environmental Operating temperature	0 °C to 60 °C
Storage temperature	-40 °C to 85 °C
Humidity	0% to 95% relative humidity, non-condensing
Software PAC Project Basic	Includes programming, HMI software, and configuration software; included with purchase of controller.
PAC Project Professional	PAC Project Basic plus OPC 2.0-compliant OPC server, database connectivity, Opto-Control strategy and OptoDisplay project importing, and support for Ethernet link redundancy or network segmenting.
Agency certifications	(-W models only) U.S., FCC Part 15 Subpart C; Canada, IC RSS-210 (-FM models only) Factory Mutual approved
Warranty	30 months from date of manufacture

SNAP PAC R-Series Controllers

Other features	<ul style="list-style-type: none"> • Multiple protocol support including TCP/IP, FTP, EtherNet/IP, Modbus/TCP, SNMP v2.0c, OptoMMP™, and SMTP • Built-in I/O processor handles up to 16 digital, analog, and serial I/O modules on the same rack⁴ • Real-time clock • FTP server/client with file system (in RAM and in removable storage) • Scratch Pad area for peer-to-peer communication • Configurable link redundancy or segmented networking for I/O-controller subnetting (when using PAC Project Professional)
----------------	--

¹ Models manufactured before July 1, 2007 have a user-replaceable 3-volt CR2032 Lithium battery (typical service life with power off: 5 years).

² Connecting to a serial device requires configuration in PAC Manager; PAC Control handles communication.

³ Requires a Wired+Wireless model (SNAP-PAC-R1-W or SNAP-PAC-R2-W).

⁴ SNAP-PAC-R1s with serial numbers lower than 600,000 are limited to eight 4-channel digital modules per rack; remaining eight can be analog, serial, and high-density digital modules.

System Architecture

For the network shown in this diagram, either PAC Project Professional or PAC Project Basic can be used.

SNAP PAC R-series Controller in Basic Network Configuration

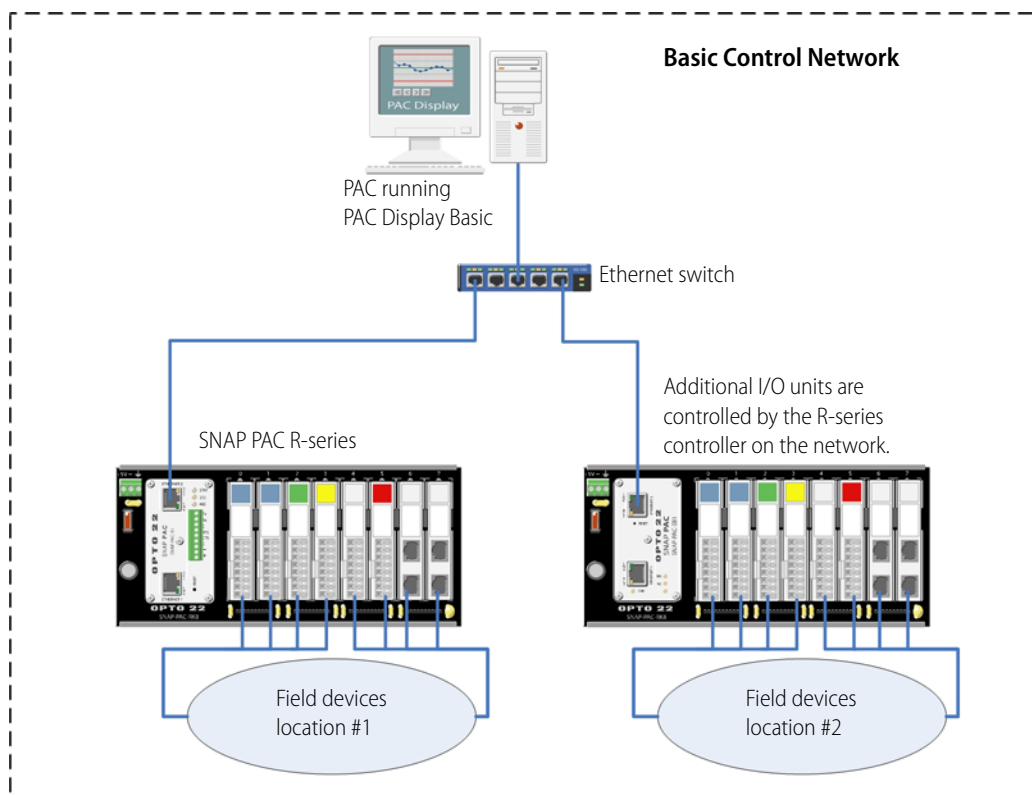

In this diagram, the SNAP PAC R-series controller uses one network interface to communicate with host computers and control I/O. The controller controls I/O on its own rack and on other Ethernet-based I/O units.

SNAP PAC R-Series Controllers

System Architecture (continued)

The network shown in this diagram requires PAC Control Professional, PAC Display Professional, and OptoDataLink.

SNAP PAC R-series Controller Segmenting Ethernet Networks

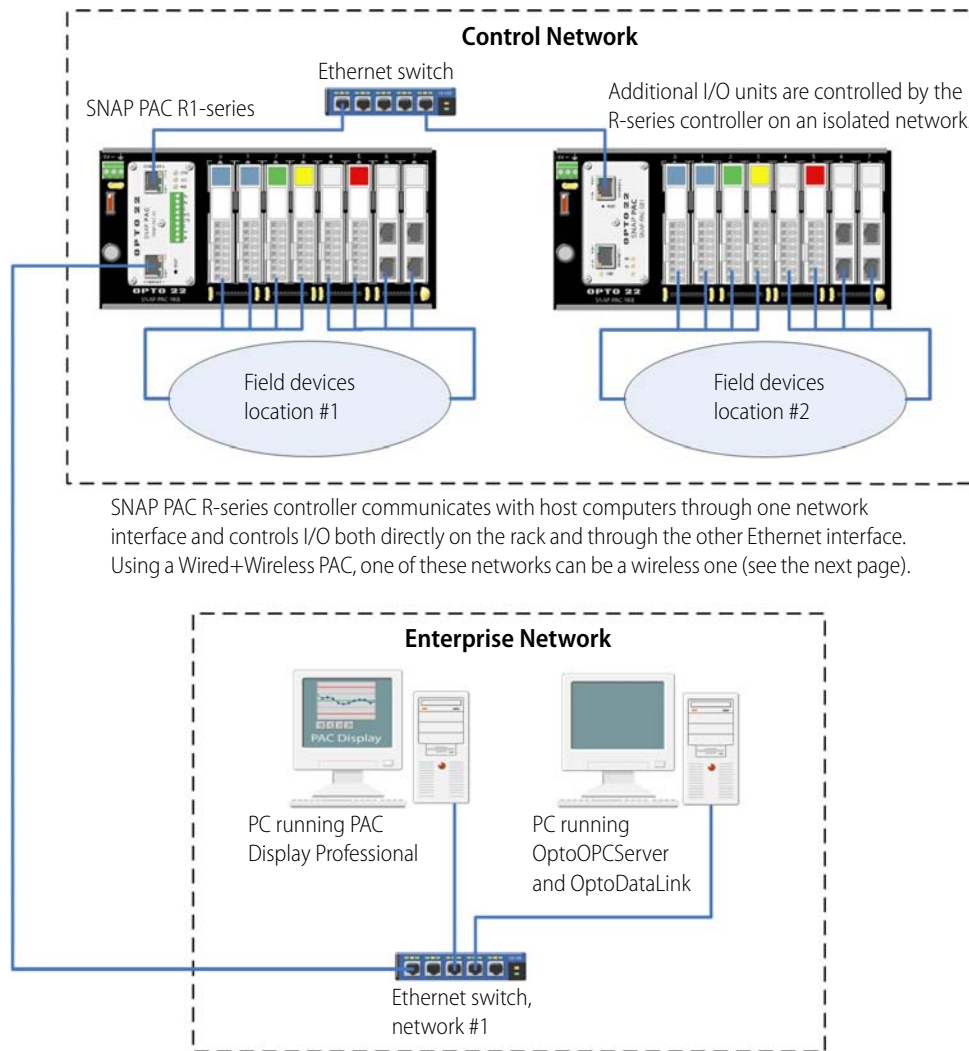

This diagram shows two SNAP PAC I/O units connected together over an Ethernet network and controlled by a SNAP PAC R-series controller running a PAC Control strategy.

The controller is also connected to a larger, separate enterprise Ethernet network to provide data to PCs running Opto 22's PAC Display HMI software, OptoOPCServer, and OptoDataLink. Sitting between the two networks, the SNAP

PAC R-series controller segments enterprise traffic from the control network.

If you use a Wired+Wireless PAC (SNAP-PAC-R1-W or SNAP-PAC-R2-W), one of these networks can be a wireless LAN. See the following page for an example.

SNAP PAC R-Series Controllers

System Architecture (continued)

The network shown in this diagram requires a Wired+Wireless R-series controller (SNAP-PAC-R1-W or SNAP-PAC-R2-W).

SNAP PAC R-series Controller Segmenting Wired and Wireless Networks

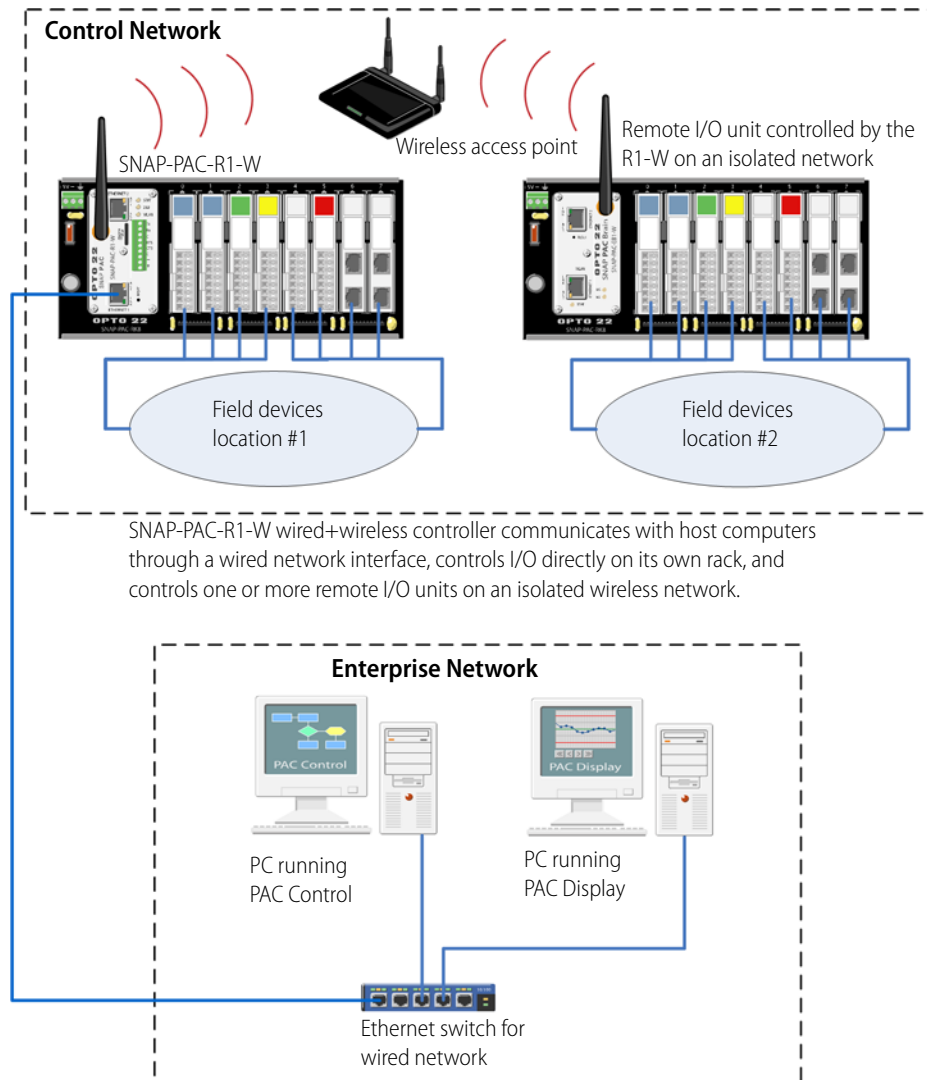

This diagram shows a SNAP PAC wired+wireless controller running a PAC Control strategy and controlling one or more remote I/O units via a wireless access point.

The controller is also connected to a separate, wired enterprise network through one of its wired Ethernet network interfaces.

The controller could just as easily talk to the I/O units through a wired network and segment the enterprise PCs on a wireless LAN.

In addition, because the wired+wireless PAC has two wired interfaces plus the wireless one, it could segment three networks—for example, a wired control network, a wired enterprise network, and a wireless connection with a laptop for maintenance or testing purposes.

SNAP PAC R-Series Controllers

System Architecture (continued)

The network shown in this diagram requires PAC Control Professional, PAC Display Professional, and OptoDataLink.

SNAP PAC R-series Controller in Redundant Network Configuration

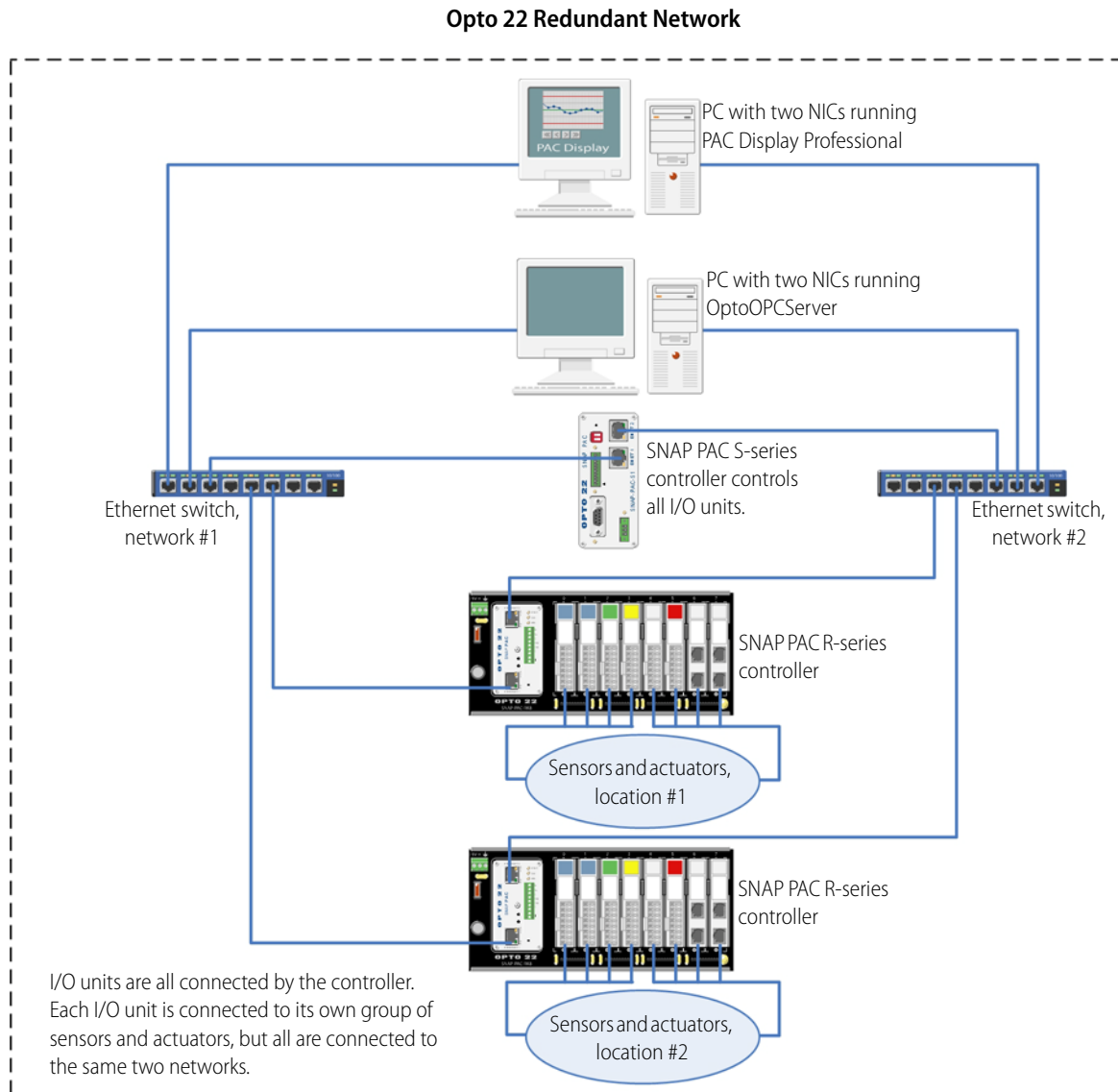

This diagram shows two SNAP PAC R-Series controllers functioning as I/O unit brains connected to two separate Ethernet networks. This configuration addresses the concern that an Ethernet network may fail or need maintenance, leaving the PC running OptoOPCServer and OptoDataLink, the PC running PAC Display, the controller, and the I/O units unable to communicate.

In this configuration, if one network goes down, devices can still communicate because the SNAP PAC R-series controllers and the SNAP PAC S-series controllers both have two network interfaces, and each PC in this system has two network interface cards.

Using a Wired+Wireless PAC (SNAP-PAC-R1-W or SNAP-PAC-R2-W) makes it possible for one of these networks to be a wireless LAN.

SNAP PAC R-Series Controllers

SNAP PAC R-Series Comparison Chart

The following table compares SNAP PAC R-series controllers with firmware version 8.5.

FEATURE		SNAP-PAC-R1	SNAP-PAC-R1-FM	SNAP-PAC-R1-W	SNAP-PAC-R2	SNAP-PAC-R2-FM	SNAP-PAC-R2-W
Factory Mutual approval			●			●	
Digital I/O point features	Input latching	●	●	●	●	●	●
	On/off status	●	●	●	●	●	●
	Watchdog timer	●	●	●	●	●	●
	High-speed counting (up to 20 kHz) ¹	●	●	●			
	Quadrature counting ²	●	●	●			
	On-pulse and off-pulse measurement ^{1,3}	●	●	●			
	Frequency and Period measurement ^{1,3}	●	●	●			
	TPO (time-proportional output) ³	●	●	●	●	●	●
	Digital totalizing ^{1,3}	●	●	●	●	●	●
Pulse generation (N pulses, continuous square wave, on-pulse, and off-pulse) ³	●	●	●	●	●	●	
Analog I/O point features	Thermocouple linearization (32-bit floating point for linearized values)	●	●	●	●	●	●
	Minimum/maximum values	●	●	●	●	●	●
	Offset and gain	●	●	●	●	●	●
	Scaling	●	●	●	●	●	●
	TPO (time-proportional output) ⁴	●	●	●	●	●	●
	Output clamping	●	●	●	●	●	●
	Filter weight	●	●	●	●	●	●
	Watchdog timer	●	●	●	●	●	●
	Analog totalizing ³	●	●	●	●	●	●
Ramping ³	●	●	●	●	●	●	
High-density digital modules (inputs and outputs)		●	●	●	●	●	●
Serial communication modules		●	●	●	●	●	●
PID logic (maximum 96 PID loops per controller)		●	●	●	●	●	●
Works with PAC Project software		●	●	●	●	●	●
Runs PAC Control strategies		●	●	●	●	●	●
Wired Ethernet network (two independent network interfaces)		●	●	●	●	●	●
Security for wired network (IP filtering, port access)		●	●	●	●	●	●
Wireless LAN interface (802.11a, b, or g)				●			●
Security for wireless network (WPA2-AES, WPA-TKIP, WEP)				●			●

SNAP PAC R-Series Controllers

FEATURE	SNAP-PAC-R1	SNAP-PAC-R1-FM	SNAP-PAC-R1-W	SNAP-PAC-R2	SNAP-PAC-R2-FM	SNAP-PAC-R2-W
OPC driver support	●	●	●	●	●	●
Modbus/TCP (slave)	●	●	●	●	●	●
EtherNet/IP for communication with Allen-Bradley RSLogix PLCs	●	●	●	●	●	●
OptoMMP memory-mapped protocol	●	●	●	●	●	●
SNMP (network management of I/O & variables)	●	●	●	●	●	●
PPP (dial-up and radio modems)	●	●	●	●	●	●
FTP server and client	●	●	●	●	●	●
Email (SMTP client)	●	●	●	●	●	●
UDP Streaming of I/O data to host	●	●	●	●	●	●
Serial port (RS-232)	●	●	●	●	●	●
Scratch Pad area—bits, floats, integers, strings	●	●	●	●	●	●
Digital events, alarm events, serial events	●	●	●	●	●	●
Event messages	●	●	●	●	●	●
Data logging in the controller	●	●	●	●	●	●
I/O point data mirroring and memory map copying	●	●	●	●	●	●
Realtime clock (RTC)	●	●	●	●	●	●
Mounting rack	SNAP PAC racks					
Number of modules per mounting rack	4, 8, 12, or 16					
Module types and maximum numbers allowed per I/O unit (with largest rack)	16 digital (any type) 16 analog 8 serial					

1 4-channel digital modules only; not available on high-density digital modules

2 Requires a SNAP quadrature input module (SNAP-IDC5Q)

3 Requires PAC Control Professional 8.2 or newer, or PAC Control Basic 9.0 or newer

4 Requires a SNAP analog TPO module (SNAP-AOD-29)

SNAP PAC R-Series Controllers

Connectors and Indicators

The following information applies to all SNAP PAC R-series controllers *except* Wired+Wireless models. See [page 12](#) for -W models.

NOTE: The microSD card slot is included in R-series PACs manufactured in November 2008 and later. PACs manufactured before November 2008 do not have this feature.

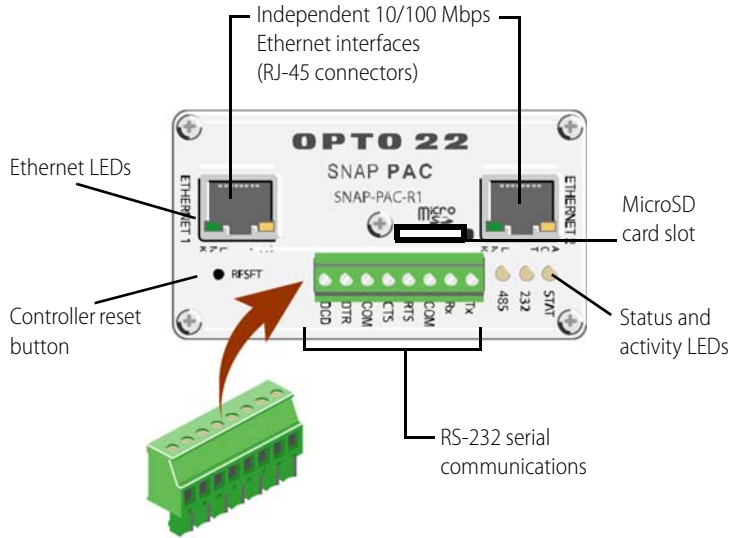

RS-232 Port (Port 0)

Pin	Description
1	TX
2	RX
3	COM
4	RTS
5	CTS
6	COM
7	DTR
8	DCD

Status and Activity LEDs

Indicator	Description
ACT	Ethernet network activity
LNK	Link established with Ethernet network
STAT	Startup status, control program operational status, MicroSD card access
232	RS-232 serial activity
PPP	PPP status

RS-232 Serial Cable Wiring*

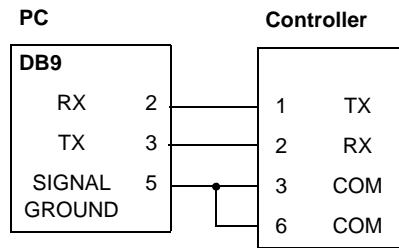

* Minimum requirements for wiring an RS-232 serial cable to connect to a PC. If you want to connect the controller to a modem, see form #1595, the *SNAP PAC R-Series Controllers User's Guide*, for all eight pin connections.

SNAP PAC R-Series Controllers

Connectors and Indicators (continued)

The following information applies to Wired+Wireless models (SNAP-PAC-R1-W and SNAP-PAC-R2-W).

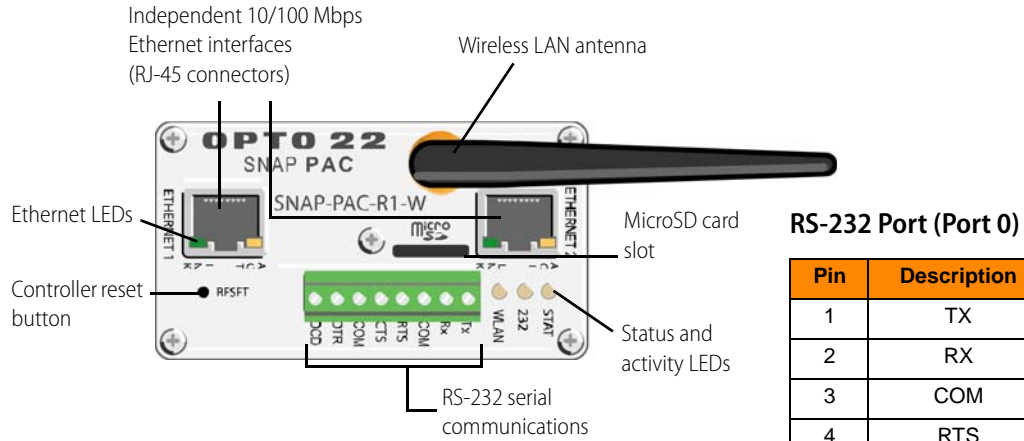

RS-232 Port (Port 0)

Pin	Description
1	TX
2	RX
3	COM
4	RTS
5	CTS
6	COM
7	DTR
8	DCD

LEDs*

Indicator	Description
ACT	Ethernet network activity
LNK	Link established with Ethernet network
STAT	Startup status, control program operational status, MicroSD card access
232	RS-232 serial activity
WLAN	Wireless LAN status

* The WLAN LED replaces the PPP LED on -W models. These models can still communicate using PPP even though they do not have the indicator.

RS-232 Serial Cable Wiring**

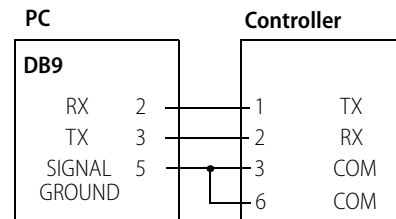

* Minimum requirements for wiring an RS-232 serial cable to connect to a PC. If you want to connect the controller to a modem, see form #1595, the *SNAP PAC R-Series Controllers User's Guide*, for all eight pin connections.

SNAP PAC R-Series Controllers

Dimensions

This diagram applies to all R-series PACs except -W models.
See the following page for dimensions on Wired+Wireless R-series PACs.

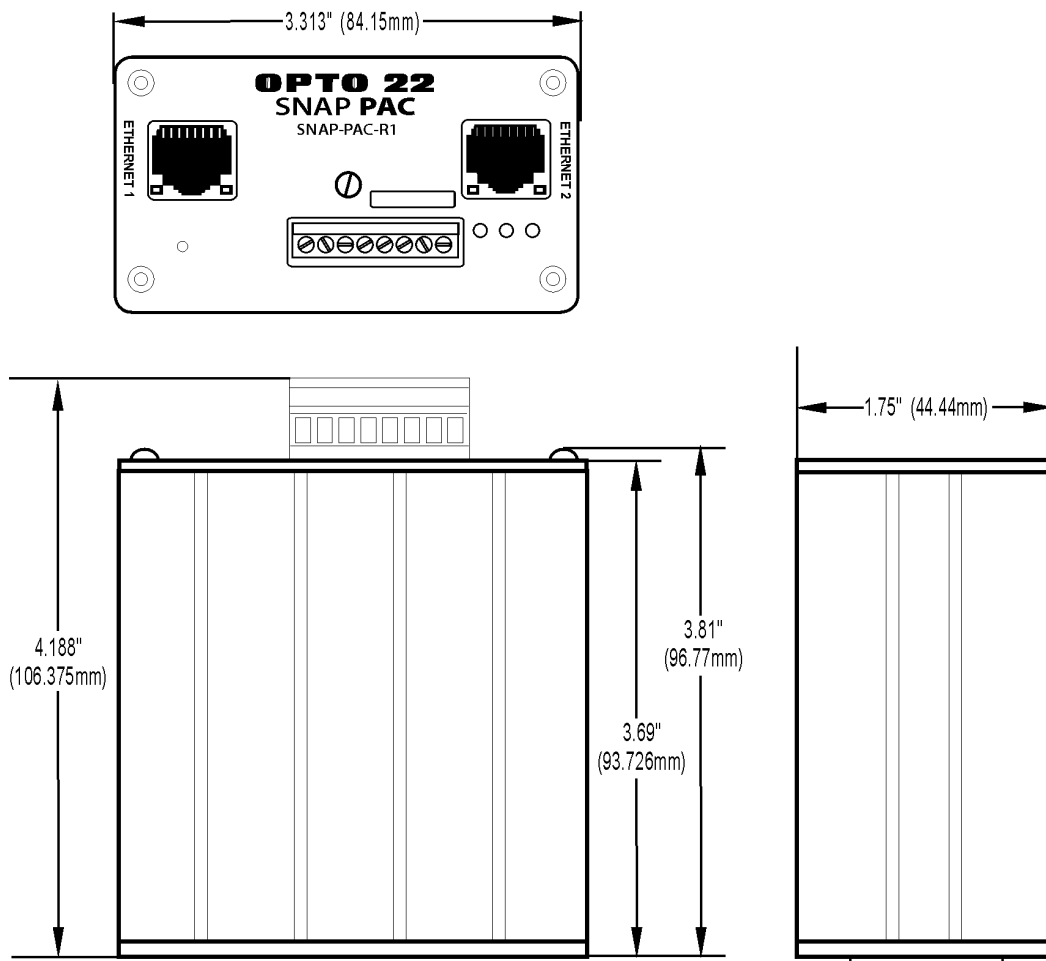

SNAP PAC R-Series Controllers

Dimensions

This diagram applies to Wired+Wireless R-series PACs (SNAP-PAC-R1-W and SNAP-PAC-R2-W).

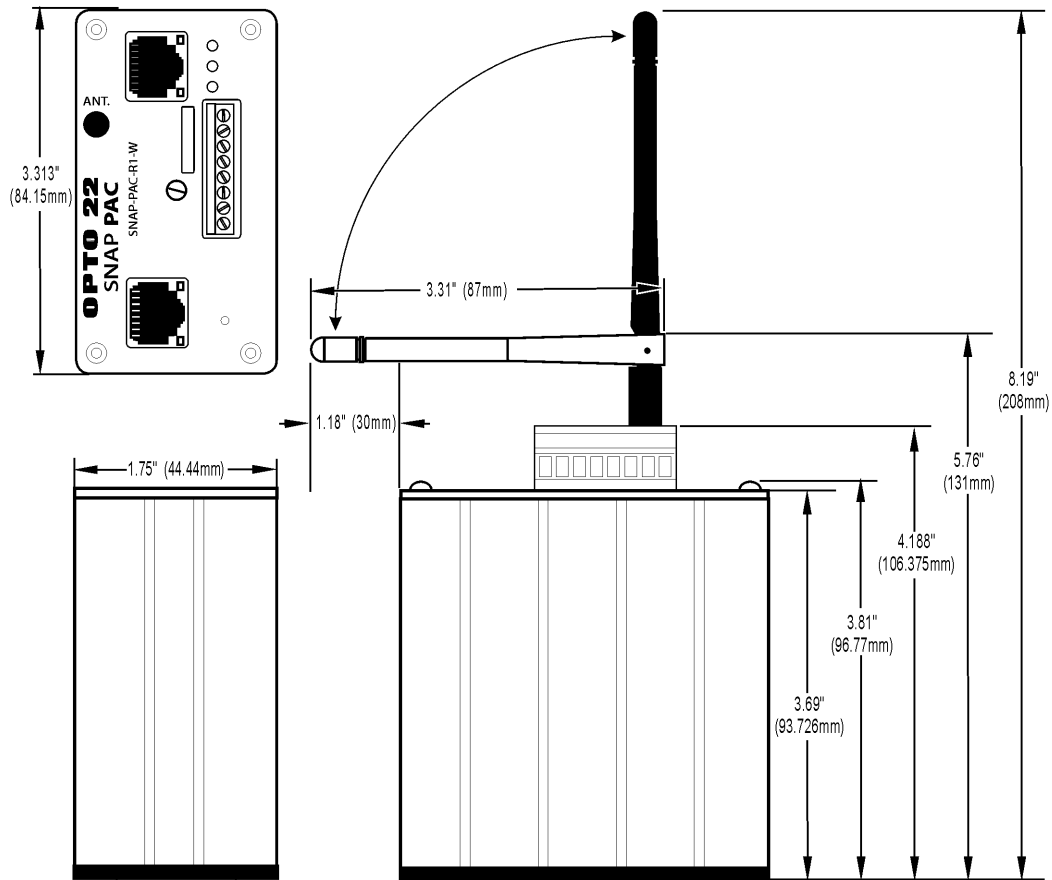

More About Opto 22

Products

Opto 22 develops and manufactures reliable, flexible, easy-to-use hardware and software products for industrial automation, remote monitoring, and data acquisition applications.

SNAP PAC System

Designed to simplify the typically complex process of understanding, selecting, buying, and applying an automation system, the SNAP PAC System consists of four integrated components:

- SNAP PAC controllers
- PAC Project™ Software Suite
- SNAP PAC brains
- SNAP I/O™

SNAP PAC Controllers

Programmable automation controllers (PACs) are multifunctional, multidomain, modular controllers based on open standards and providing an integrated development environment.

Opto 22 has been manufacturing PACs for many years. The latest models include the standalone SNAP PAC S-series and the rack-mounted SNAP PAC R-series. Both handle a wide range of digital, analog, and serial functions and are equally suited to data collection, remote monitoring, process control, and discrete and hybrid manufacturing.

SNAP PACs are based on open Ethernet and Internet Protocol (IP) standards, so you can build or extend a system without the expense and limitations of proprietary networks and protocols.

PAC Project Software Suite

Opto 22's PAC Project Software Suite provides full-featured and cost-effective control programming, HMI (human machine interface) development and runtime, OPC server, and database connectivity software to power your SNAP PAC System.

These fully integrated software applications share a single tagname database, so the data points you configure in PAC Control™ are immediately available for use in PAC Display™, OptoOPCServer™, and OptoDataLink™. Commands are in plain English; variables and I/O point names are fully descriptive.

PAC Project Basic offers control and HMI tools and is free for download on our website, www.opto22.com. PAC Project Professional, available for separate purchase, adds OptoOPCServer, OptoDataLink, options for Ethernet link redundancy or segmented networking, and support for legacy Opto 22 serial *mistic*™ I/O units.

SNAP PAC Brains

While SNAP PAC controllers provide central control and data distribution, SNAP PAC brains provide distributed intelligence for I/O processing and communications. Brains offer analog, digital, and serial functions, including thermocouple linearization; PID loop control; and optional high-speed digital counting (up to 20 kHz), quadrature counting, TPO, and pulse generation and measurement.

SNAP I/O

I/O provides the local connection to sensors and equipment. Opto 22 SNAP I/O offers 1 to 32 points of reliable I/O per module, depending on the type of module and your needs. Analog, digital, serial, and special-purpose modules are all mixed on the same mounting rack and controlled by the same processor (SNAP PAC brain or rack-mounted controller).

Quality

Founded in 1974 and with over 85 million devices sold, Opto 22 has established a worldwide reputation for high-quality products. All are made in the U.S.A. at our manufacturing facility in Temecula, California. Because we do no statistical testing and each part is tested twice before leaving our factory, we can guarantee most solid-state relays and optically isolated I/O modules for life.

Free Product Support

Opto 22's Product Support Group offers free, comprehensive technical support for Opto 22 products. Our staff of support engineers represents decades of training and experience. Product support is available in English and Spanish, by phone or email, Monday through Friday, 7 a.m. to 5 p.m. PST.

Free Customer Training

Hands-on training classes for the SNAP PAC System are offered at our headquarters in Temecula, California. Each student has his or her own learning station; classes are limited to nine students. Registration for the free training class is on a first-come, first-served basis. See our website, www.opto22.com, for more information or email training@opto22.com.

Purchasing Opto 22 Products

Opto 22 products are sold directly and through a worldwide network of distributors, partners, and system integrators. For more information, contact Opto 22 headquarters at 800-321-6786 or 951-695-3000, or visit our website at www.opto22.com.

www.opto22.com