

SNAP Isolated Analog Input Modules

Features

- Channel-to-channel isolation
- Rugged packaging and convenient pluggable wiring. Accepts up to 14 AWG wire.
- Factory calibrated; no user adjustment necessary
- Out-of-range indication
- Operating temperature 0 °C to 70 °C

Description

SNAP I/O isolated analog input modules provide two or more channels isolated from each other, thereby eliminating problems caused by ground loop currents. These isolated analog modules are part of Opto 22's SNAP PAC System and mount on SNAP PAC racks with an I/O processor (brain or on-the-rack controller). SNAP isolated analog input modules are compatible with all SNAP PAC brains and rack-mounted controllers, including Wired+Wireless™.

Since many SNAP analog input modules are software-configurable and handle a wide variety of signal levels, a small number of modules can support a wide range of input requirements. Modules provide high resolution for precise signal levels, and all SNAP analog modules are factory calibrated. Part numbers ending in -FM are Factory Mutual approved. Dimensional drawings start on page 12.

SNAP analog input modules have an on-board microprocessor to provide module-level intelligence, making them an ideal choice for original equipment manufacturers (OEMs). For more information about the standalone operation of SNAP analog modules, see the *SNAP I/O Module Integration Guide* (Opto 22 form #876).

SNAP racks use a retention rail locking system that holds modules in place. In addition, Opto 22 recommends using two 4-40 by 1/2-inch standard machine screws to secure each module to the rack (recommended torque: 4 inch pounds [0.45 Newton meters]).

Notes for legacy hardware: SNAP-AITM-4i requires SNAP PAC racks and I/O processors. Other modules can be used with SNAP Simple, SNAP Ethernet, SNAP Ultimate, and SNAP *mistic* brains such as the serial B3000, and M-series or B-series mounting racks.

Isolation

All SNAP analog input modules are transformer isolated as well as optically isolated from all other modules and from the I/O processor. In addition, the modules in this data sheet have



SNAP Isolated Analog Input Modules

two or more channels isolated from each other. Channel-to-channel isolation gives you complete freedom from ground-loop problems even on grounded devices connected to channels on the same module.

Transformer isolation prevents ground loop currents from flowing between field devices and causing noise that produces erroneous readings. Ground loop currents are caused when two grounded field devices share a connection, and the ground potential at each device is different. Optical isolation provides 4,000 volts of transient (4,000 V for 1 ms) protection for sensitive control electronics from industrial field signals.

Part Numbers

Part	Description	Pg
SNAP-AIARMS-i SNAP-AIARMS-i-FM*	Isolated two-channel 0 to 10 amp RMS AC/DC input	2
SNAP-AIVRMS-i SNAP-AIVRMS-i-FM*	Isolated two-channel 0 to 250 V RMS AC/DC input	3
SNAP-AIMA-i	Isolated two-channel analog current input -20 mA to +20 mA	4
SNAP-AIMA-iSRC SNAP-AIMA-iSRC-FM*	Isolated two-channel analog current input -20 mA to +20 mA, with loop sourcing	5
SNAP-AIMA2-i	Isolated two-channel analog current input -1 mA to +1 mA	6
SNAP-AITM-i	Isolated two-channel analog type E, J, or K thermocouple or ±150 mV or ±75 mV input	7
SNAP-AITM2-i	Isolated two-channel analog type B, C, D, G, N, T, R, or S thermocouple or ±50 mV or ±25 mV input	8
SNAP-AITM-4i	Isolated four-channel analog type B, C, D, E, G, J, K, N, R, S, or T thermocouple or ±150 mV, ±75 mV, ±50 mV, or ±25 mV input	9
SNAP-AIV-i	Isolated two-channel analog voltage input ±10 VDC or ±5 VDC	10
SNAP-AIV2-i	Isolated two-channel analog voltage input ±100 VDC or ±50 VDC	11

* Factory Mutual approved

Isolated 0 to 10 Amp RMS AC/DC Input Module

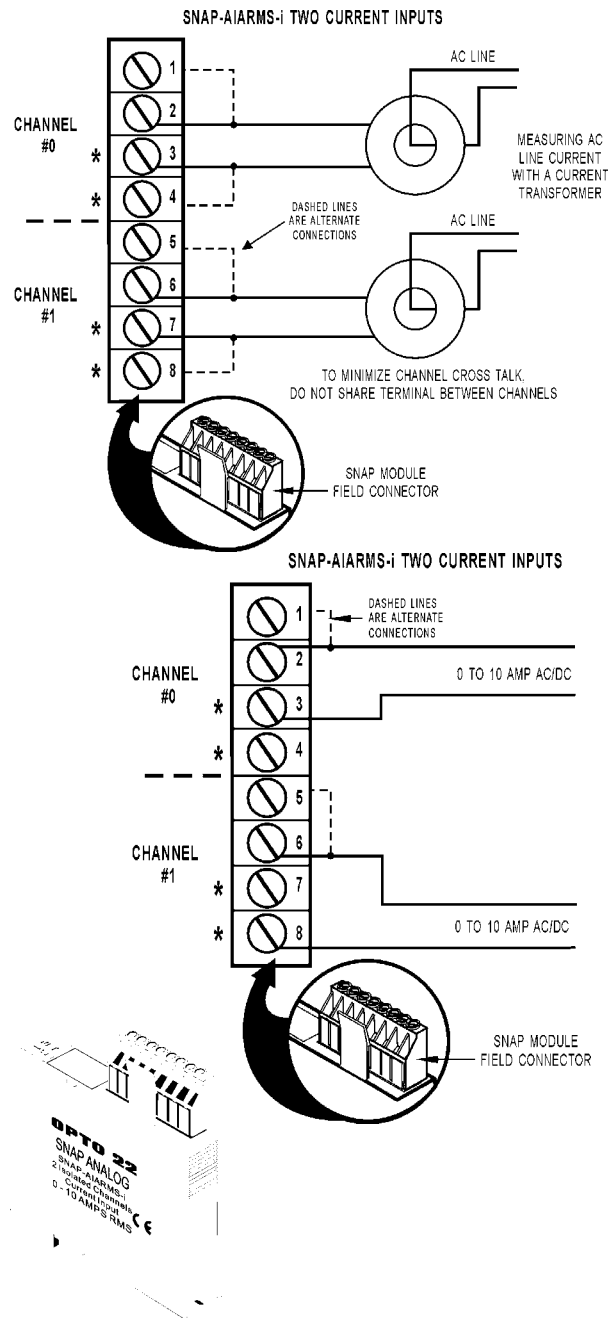

IMPORTANT: The mounting rack connector has 24 pins; the module connector has 20 pins. The extra pins on the mounting rack connector prevent misalignment of the module during installation.

Part Number	Description
SNAP-AIARMS-i	Isolated two-channel 0 to 10 amp RMS AC/DC input
SNAP-AIARMS-i-FM	Isolated two-channel 0 to 10 amp RMS AC/DC input

Description

The SNAP-AIARMS-i and SNAP-AIARMS-i-FM modules provide an input range of 0 to 10 amps RMS AC/DC. An ideal input is the 5-amp secondary of a standard current transformer used to monitor AC line current. These modules may also be used to monitor AC current to greater than a 100-amp range, using a current transformer of suitable ratio. The SNAP-AIARMS-i-FM module is Factory Mutual approved.

The two channels are isolated from each other; they do not share any field connection. These modules are ideal for differential current measurements.

Specifications

Input Range	0 to 10 amp RMS AC/DC
Input Over Range	To 11 amps
Input Resistance	0.005 ohms
Maximum Input	11 amps AC/DC
Accuracy (AC)	±8 mA and ±0.2% reading
Resolution	400 µA
DC Reversal	±16 mA (0.16%)
Input Response Time (Step Change)	63.2% (6.32 A) in 50 ms 99% (9.92 A) in 75 ms
DC Common Mode Rejection	>-120 dB
AC Common Mode Rejection	>-120 dB at 60 Hz
Maximum Operating Voltage Between Channels Common Mode Voltage	250 V 250 V
Isolation: Optical	4000 V
Isolation: Transformer	1500 V
Isolation: Channel to Channel	250 V continuous (1500 V transient)
Power Requirements	5 VDC (±0.15 V) at 200 mA
Ambient Temperature: Operating Storage	0 °C to 70 °C -25 °C to 85 °C
Torque, hold-down screws	4 in-lb (0.45 N-m)
Torque, connector screws	5.26 in-lb (0.6 N-m)
Agency Approvals	CE, RoHS, DFARS FM (SNAP-AIARMS-FM only)
Warranty	Lifetime

SNAP Isolated Analog Input Modules

Isolated 0 to 250 Volt RMS AC/DC Input Module

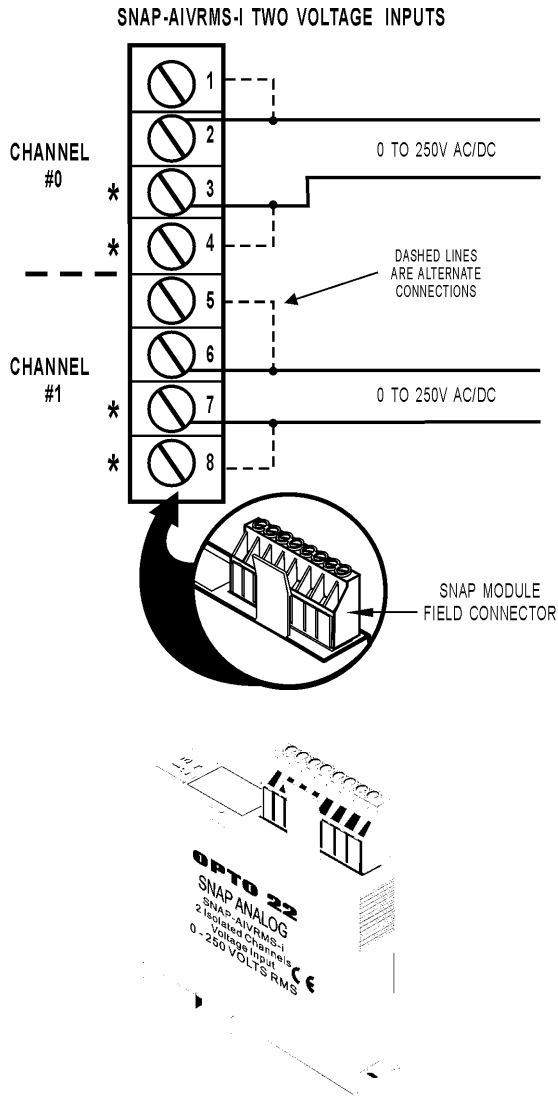

IMPORTANT: The mounting rack connector has 24 pins; the module connector has 20 pins. The extra pins on the mounting rack connector prevent misalignment of the module during installation.

Part Number	Description
SNAP-AIVRMS-i	Isolated two-channel 0 to 250 V RMS
SNAP-AIVRMS-i-FM	AC/DC input

Description

The SNAP-AIVRMS-i and SNAP-AIVRMS-i-FM modules provide an input range of 0 to 250 volts AC or DC. These modules may be used to monitor 120/240-volt AC/DC and 12/24/48-volt AC/DC system voltage. The SNAP-AIVRMS-i-FM module is Factory Mutual approved.

The two channels are isolated from each other; they do not share any field connection. These modules are ideal for differential voltage measurements.

Specifications

Input Range	0 to 250 V RMS AC/DC
Input Over Range	To 275 V
Input Resistance	1 megohms
Accuracy	±0.2 V and ±0.2% reading
Resolution	10 mV
DC Reversal	± 0.2 V (0.08%)
Input Response Time (Step Change)	63.2% (158 V) in 50 ms 99% (248 V) in 75 ms
DC Common Mode Rejection	>-120 dB
AC Common Mode Rejection	>-120 dB @ 60 Hz
Maximum Operating Voltage Between Channels Common Mode Voltage	250 V 250 V
Isolation: Optical	4000 V
Isolation: Transformer	1500 V
Isolation: Channel to Channel	250 V continuous (1500 V transient)
Power Requirements	5 VDC (±0.15 V) at 200 mA
Ambient Temperature: Operating Storage	0 °C to 70 °C -25 °C to 85 °C
Torque, hold-down screws	4 in-lb (0.45 N-m)
Torque, connector screws	5.26 in-lb (0.6 N-m)
Agency Approvals	CE, RoHS, DFARS
Warranty	Lifetime

SNAP Isolated Analog Input Modules

Isolated Current Input Module -20 mA to +20 mA

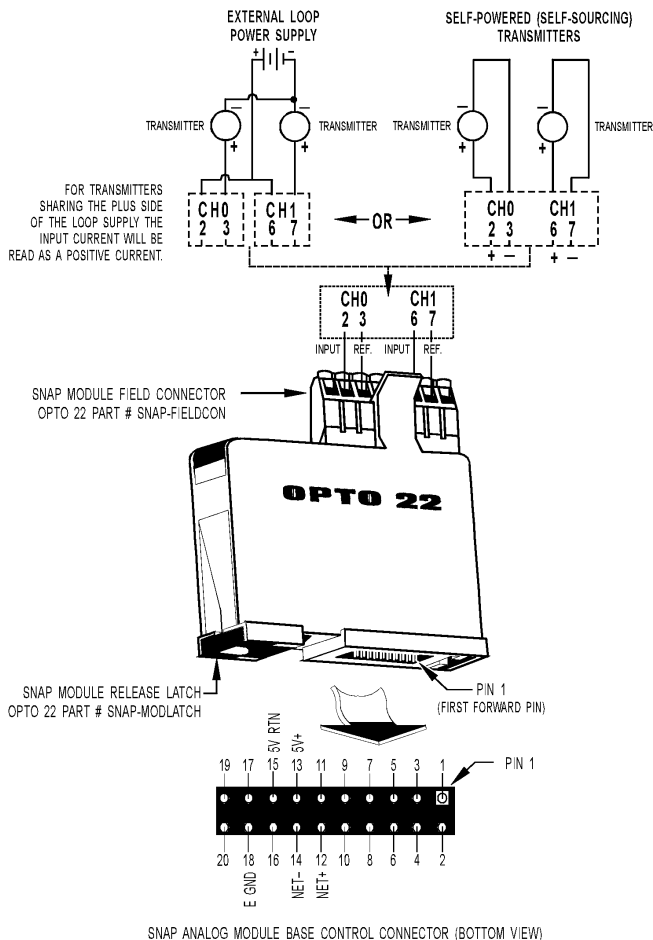

IMPORTANT: The mounting rack connector has 24 pins; the module connector has 20 pins. The extra pins on the mounting rack connector prevent misalignment of the module during installation.

Part Number	Description
SNAP-AIMA-i	Isolated two-channel analog current input -20 mA to +20 mA

Description

The SNAP-AIMA-i module provides an input range of -20mA to +20mA. The SNAP-AIMA-i has two channels that are isolated from each other. This module DOES NOT supply loop excitation current. See [page 5](#) for a loop sourcing model.

Specifications

Input Range	-20 mA to +20 mA
Maximum Over Range	± 10% (= ± 27500 counts)
Resolution	0.8 µA
Input Response Time (% of span/delta I/delta time)	99.9 %/19.9 µA/10 ms
DC Common Mode Rejection	>-120 dB
AC Common Mode Rejection	>-120 dB @ 60 Hz
Maximum Survivable Input	36 mA or 9 VDC
Maximum Operating Common Mode Voltage	250 V
Accuracy	0.05% (10 µA)
Isolation: Optical	4000 V
Isolation: Transformer	1500 V
Isolation: Channel to Channel	250 V continuous (1500 V transient)
DRIFT: Gain Temperature Coefficient	30 PPM/ °C
DRIFT: Offset Temperature Coefficient	15 PPM/ °C
Power Requirements	5 VDC (±0.15) @ 200 mA
Input Resistance - Single Ended	200 ohms (each channel)
Ambient Temperature: Operating Storage	0 °C to 70 °C -25 °C to 85 °C
Torque, hold-down screws	4 in-lb (0.45 N-m)
Torque, connector screws	5.26 in-lb (0.6 N-m)
Agency Approvals	UL, CE, FM, RoHS, DFARS
Warranty	Lifetime

SNAP Isolated Analog Input Modules

Isolated Current Input Module -20mA to +20mA with Loop Sourcing

Specifications

Input Range	0 to +20 mA with loop sourcing -20 mA to +20 mA
Maximum Over Range	± 10% (= ± 27500 counts)
Resolution	0.8 µA
Input Response Time (% of span/delta I/delta time)	99.9 %/19.9 mA/10 ms
DC Common Mode Rejection	>-120 dB
AC Common Mode Rejection	>-120 dB @ 60 Hz
Maximum Survivable Input	36 mA or 9 VDC
Maximum Operating Common Mode Voltage	250 V
Accuracy	0.05% (10 µA)
DRIFT: Gain Temperature Coefficient	30 PPM/ °C
DRIFT: Offset Temperature Coefficient	15 PPM/ °C
Isolation: Optical	4000 V
Isolation: Transformer	1500 V
Isolation: Channel to Channel	250 V continuous (1500 V transient)
Power Requirements	5 VDC (±0.15) @ 200 mA
Power Requirements - Loop Power (Input)	From separate field connector: 24 VDC nominal (70 mA max @ 24 V input, both loops @ 20 mA), 30 VDC maximum
Loop Power (Output)	24 VDC (± 1.5 V) @ 20 mA Open loop: 30 V maximum Shorted loop: 24 mA nominal
Input Resistance	200 ohms (each channel)
Ambient Temperature: Operating Storage	0 °C to 70 °C -25 °C to 85 °C
Torque, hold-down screws	4 in-lb (0.45 N-m)
Torque, connector screws	5.26 in-lb (0.6 N-m)
Agency Approvals	CE, RoHS, DFARS FM (SNAP-AIMA-iSRC-FM only)
Warranty	Lifetime

Part Number	Description
SNAP-AIMA-iSRC SNAP-AIMA-iSRC-FM	Isolated two-channel analog current input -20 mA to +20 mA, with loop sourcing

Description

The SNAP-AIMA-iSRC and SNAP-AIMA-iSRC-FM are similar to the SNAP-AIMA-i module but include built-in loop sourcing capability. With the connection of a single 24 V power supply, these modules source 24 V for two 4–20 mA loops. The loops are internally connected to the individual inputs. The two channels and their loop sources are isolated from each other; they do not share any field connection. In addition, each loop source is current limited so that an external fault on one loop will not affect the other.

The SNAP-AIMA-iSRC-FM is Factory Mutual approved.

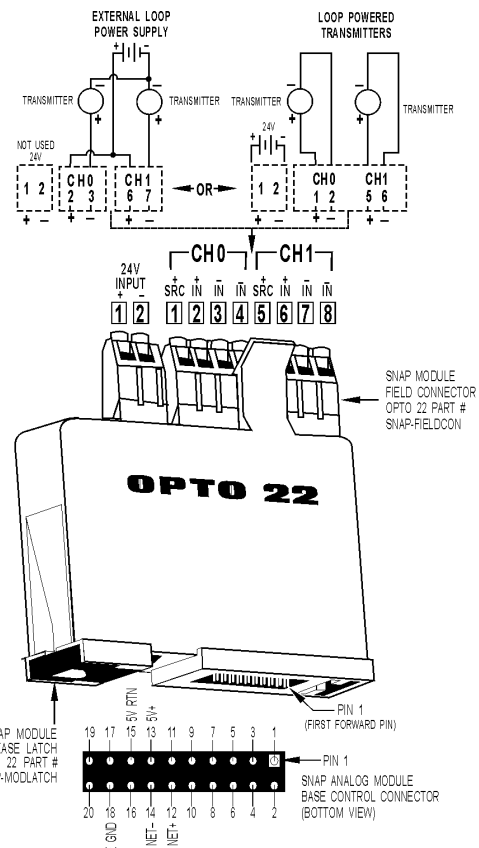

IMPORTANT: The mounting rack connector has 24 pins; the module connector has 20 pins. The extra pins on the mounting rack connector prevent misalignment of the module during installation.

SNAP Isolated Analog Input Modules

Isolated Current Input Module -1 mA to +1 mA

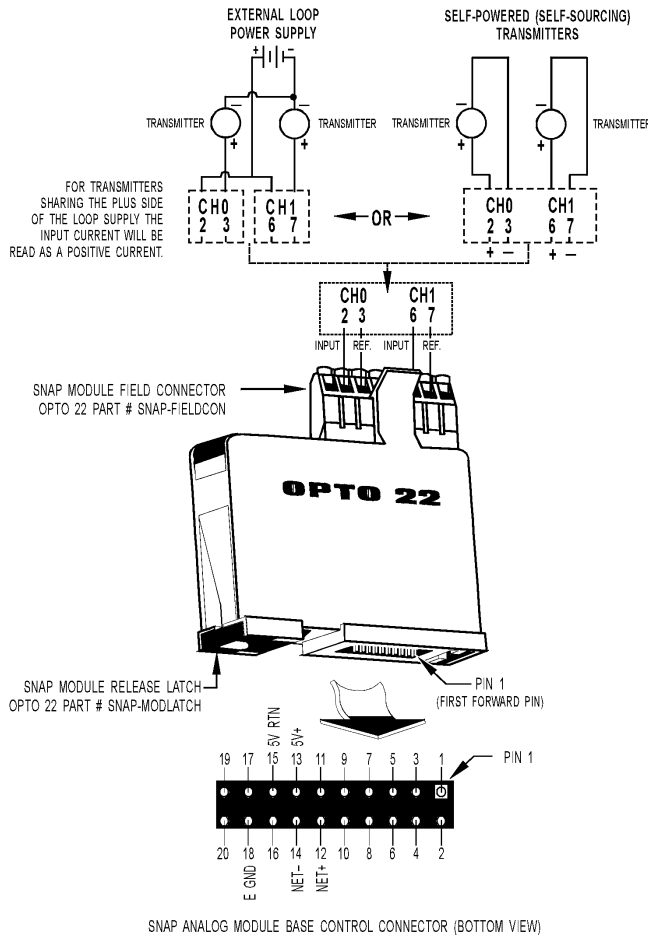

IMPORTANT: The mounting rack connector has 24 pins; the module connector has 20 pins. The extra pins on the mounting rack connector prevent misalignment of the module during installation.

Part Number	Description
SNAP-AIMA2-i	Isolated two-channel analog current input -1 mA to +1 mA

Description

The SNAP-AIMA2-i module provides an input range of -1 mA to +1 mA. The SNAP-AIMA2-i has two channels that are isolated from each other. This module DOES NOT supply loop excitation current.

Specifications

Input Range	-1 mA to +1mA
Maximum Over Range	± 10% (= ± 27500 counts)
Resolution	0.04 µA
Input Response Time (% of span/delta I/delta time)	99.9 %/19.9 µA/10 ms
DC Common Mode Rejection	>-120 dB
AC Common Mode Rejection	>-120 dB @ 60 Hz
Maximum Survivable Input	11 mA or 28 VDC
Maximum Operating Common Mode Voltage	250 V
Accuracy	0.05% (0.05 µA)
DRIFT: Gain Temperature Coefficient	30 PPM/ °C
DRIFT: Offset Temperature Coefficient	15 PPM/ °C
Isolation: Optical	4000 V
Isolation: Transformer	1500 V
Isolation: Channel to Channel	250 V continuous (1500 V transient)
Power Requirements	5 VDC (±0.15) @ 200 mA
Input Resistance	5 K ohms (each channel)
Ambient Temperature: Operating Storage	0 °C to 70 °C -25 °C to 85 °C
Torque, hold-down screws	4 in-lb (0.45 N-m)
Torque, connector screws	5.26 in-lb (0.6 N-m)
Agency Approvals	CE, RoHS, DFARS
Warranty	Lifetime

SNAP Isolated Analog Input Modules

Isolated Thermocouple/ Millivolt Input Module

Specifications

Input Range	From -150 mV to +150 mV From -75 mV to +75 mV
Maximum Over Range	± 10% (= ± 27500 counts)
Resolution	6 µV from -150 mV to +150 mV 3 µV from -75 mV to +75 mV
Cold Junction Temperature Compensation	Automatic when used with SNAP brains
Input Filtering	-3 dB @ 7 Hz
Input Response Time (% of span/delta V/delta time)	63.2%/95 mV/23 mS
DC Common Mode Rejection	>-120 dB
AC Common Mode Rejection	>-120 dB @ 60 Hz
Maximum Survivable Input	±15 volts
Maximum Operating Common Mode Voltage	250 V
Accuracy	0.06% (90 µV) @ 150 mV (full scale) 0.1% (75 µV) @ 75 mV (full scale)
Drift: Gain Temperature Coefficient	5 µV / °C
Drift: Offset Temperature Coefficient	2 µV / °C
Thermocouple Accuracy [°C] From factory After user gain and offset commands	± 2.0 (E, J, and K) ± 0.8
Isolation: Optical	4000 V
Isolation: Transformer	1500 V
Isolation: Channel to Channel	250 V continuous (1500 V transient)
Power Requirements	5 VDC (±0.15) @ 200 mA
Input Resistance	100 megohms (each channel)
Ambient Temperature: Operating Storage	0 °C to 70 °C -25 °C to 85 °C
Torque, hold-down screws	4 in-lb (0.45 N-m)
Torque, connector screws	5.26 in-lb (0.6 N-m)
Agency Approvals	CE, FM, RoHS, DFARS
Warranty	Lifetime

Part Number	Description
SNAP-AITM-i	Isolated two-channel analog type E, J, or K thermocouple or -150 mV to +150 mV input or -75 mV to +75 mV input

Description

The SNAP-AITM-i module provides two channels of analog to digital conversion. Each channel on the module can be configured for -150 mV DC to +150 mV DC or -75 mV DC to +75 mV DC, or for type E, J, or K thermocouple operation. The two channels are isolated from each other. Since these channels do not share any common connections, grounded sensors and field devices may be used with them.

Type	-	+	Range
E	Red	Purple	-270 °C to +1,000 °C
J	Red	White	-210 °C to +1,200 °C
K	Red	Yellow	-270 °C to +1,372 °C

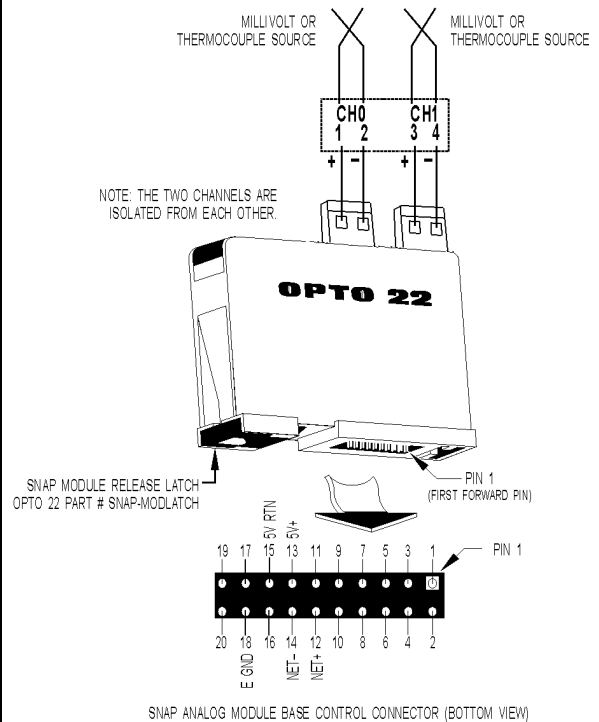

IMPORTANT: The mounting rack connector has 24 pins; the module connector has 20 pins. The extra pins on the mounting rack connector prevent misalignment of the module during installation.

SNAP Isolated Analog Input Modules

Isolated Thermocouple/ Millivolt Input Module

Type	-	+	Range
B	RED	GRAY	+42 °C to +1,820 °C
C, D, G	RED	WHITE	0 °C to +2,320 °C
N	RED	ORANGE	-270 °C to +1,300 °C
R, S	RED	BLACK	-50 °C to +1,768 °C
T	RED	BLUE	-270 °C to +400 °C

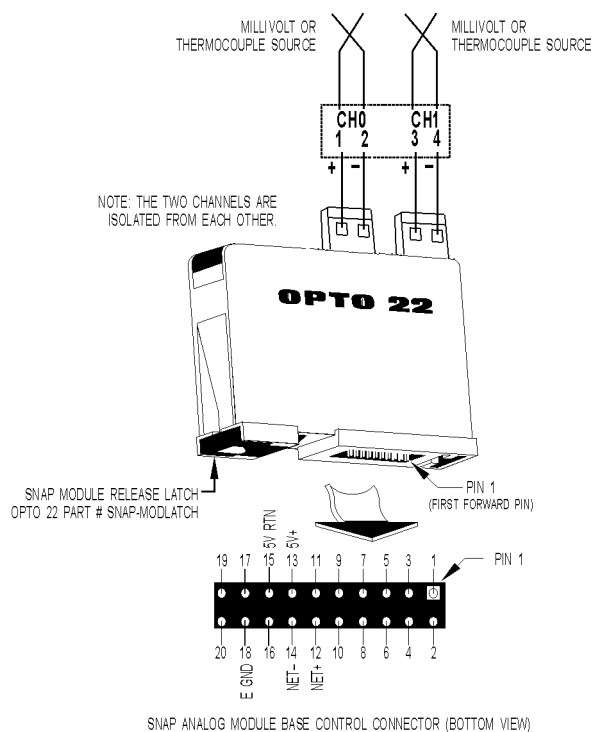

IMPORTANT: The mounting rack connector has 24 pins; the module connector has 20 pins. The extra pins on the mounting rack connector prevent misalignment of the module during installation.

Description

The SNAP-AITM2-i module provides an input range of ± 50 mV, ± 25 mV, or Type B, C, D, G, N, T, R, or S thermocouple.

The two channels on the module are isolated from each other. Since these channels do not share any common connections, grounded sensors and field devices may be used with them.

Part Number	Description
SNAP-AITM2-i	Isolated two-channel analog type B, C, D, G, N, T, R, or S thermocouple or -50 mV to +50 mVDC input or -25 mV to +25 mVDC input

Specifications

Input Range	From -50 mV to +50 mVDC From -25 mV to +25 mVDC
Maximum Over Range	$\pm 10\%$ (= ± 27500 counts)
Resolution	2 μ V from -50 mV to +50 mV 1 μ V from -25 mV to +25 mV
Cold Junction Temperature Compensation	Automatic when used with SNAP brains
Input Filtering	-3 dB @ 2.4 Hz
Input Response Time (% of span/delta V/delta time)	63.2%/31.5 mV/66 ms
DC Common Mode Rejection	>-120 dB
AC Common Mode Rejection	>-120 dB @ 60 Hz
Maximum Survivable Input	± 15 volts
Maximum Operating Common Mode Voltage	250 V
Accuracy	0.1% (50 μ V) @ 50 mV (full scale) 0.2% (50 μ V) @ 25 mV (full scale)
Drift: Gain Temperature Coefficient	5 μ V / °C
Drift: Offset Temperature Coefficient	2 μ V / °C
Thermocouple Accuracy [°C]	B, R, S C, D, G T, N
From factory	± 5 ± 4 ± 3
After user gain and offset commands	± 3 ± 2 ± 2
Isolation: Optical	4000 V
Isolation: Transformer	1500 V
Isolation: Channel to Channel	250 V continuous (1500 V transient)
Power Requirements	5 VDC (± 0.15) @ 200 mA
Input Resistance	100 megohms (each channel)
Ambient Temperature: Operating Storage	0 °C to 70 °C -25 °C to 85 °C
Torque, hold-down screws	4 in-lb (0.45 N-m)
Torque, connector screws	5.26 in-lb (0.6 N-m)
Agency Approvals	CE, FM, RoHS, DFARS
Warranty	Lifetime

SNAP Isolated Analog Input Modules

Isolated Thermocouple/ Millivolt Input Module

Specifications

Input Range	From -150 mV to +150 mVDC From -75 mV to +75 mVDC From -50 mV to +50 mVDC From -25 mV to +25 mVDC			
Maximum Over Range	± 10% (= ± 27500 counts)			
Resolution	6 µV from -150 mV to +150 mV 3 µV from -75 mV to +75 mV 2 µV from -50 mV to +50 mV 1 µV from -25 mV to +25 mV			
Cold Junction Temperature Compensation	Automatic when used with SNAP PAC brains			
Input Filtering	-3 dB @ 5 Hz			
Data Freshness	mV input: 75 ms Thermocouple input: 140 ms			
DC Common Mode Rejection	>-120 dB			
AC Common Mode Rejection	>-120 dB @ 60 Hz			
Maximum Survivable Input	±15 volts			
Maximum Operating Common Mode Voltage	250 V			
Accuracy	0.06% (90 µV) @ 150 mV (full scale) 0.1% (75 µV) @ 75 mV (full scale) 0.1% (50 µV) @ 50 mV (full scale) 0.2% (50 µV) @ 25 mV (full scale)			
Drift: Gain Temperature Coefficient	5 µV / °C			
Drift: Offset Temperature Coefficient	2 µV / °C			
Thermocouple Accuracy [°C]	B,R,S	C,D,G	E,J,K	N,T
From factory	±5.0	±4.0	± 2.0	±3.0
After user gain and offset commands	±3.0	±2.0	± 0.8	±2.0
Isolation: Transformer	1500 V			
Isolation: Channel to Channel	250 V continuous (1500 V transient)			
Power Requirements	5 VDC (±0.15) @ 150 mA			
Input Resistance	100 megohms (each channel)			
Torque, hold-down screws	4 in-lb (0.45 N-m)			
Torque, connector screws	5.26 in-lb (0.6 N-m)			
Agency Approvals	CE, RoHS, DFARS			
Warranty	Lifetime			

Part Number	Description
SNAP-AITM-4i	Isolated four-channel analog type B, C, D, E, G, J, K, N, R, S, or T thermocouple or ±150 mV, ±75 mV, ±50 mV, or ±25 mV input

Description

The SNAP-AITM-4i module provides an input range of ±150 mV, ±75 mV, ±50 mV, ±25 mV, or Type B, C, D, E, G, J, K, N, R, S, or T thermocouple.

The four channels on the module are isolated from each other. Since these channels do not share any common connections, grounded sensors and field devices may be used with them.

The SNAP-AITM-4i requires a SNAP PAC brain or R-series controller.

Type	-	+	Range
B	Red	Gray	+42 °C to +1,820 °C
C, D, G	Red	White	0 °C to +2,320 °C
E	Red	Purple	-270 °C to +1,000 °C
J	Red	White	-210 °C to +1,200 °C
K	Red	Yellow	-270 °C to +1,372 °C
N	Red	Orange	-270 °C to +1,300 °C
R, S	Red	Black	-50 °C to +1,768 °C
T	Red	Blue	-270 °C to +400 °C

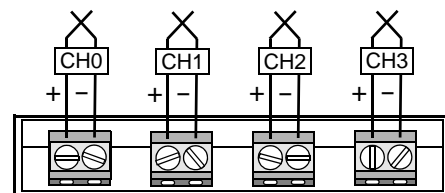

SNAP Isolated Analog Input Modules

Isolated Voltage Input Module -10 VDC to +10 VDC or -5 VDC to +5 VDC

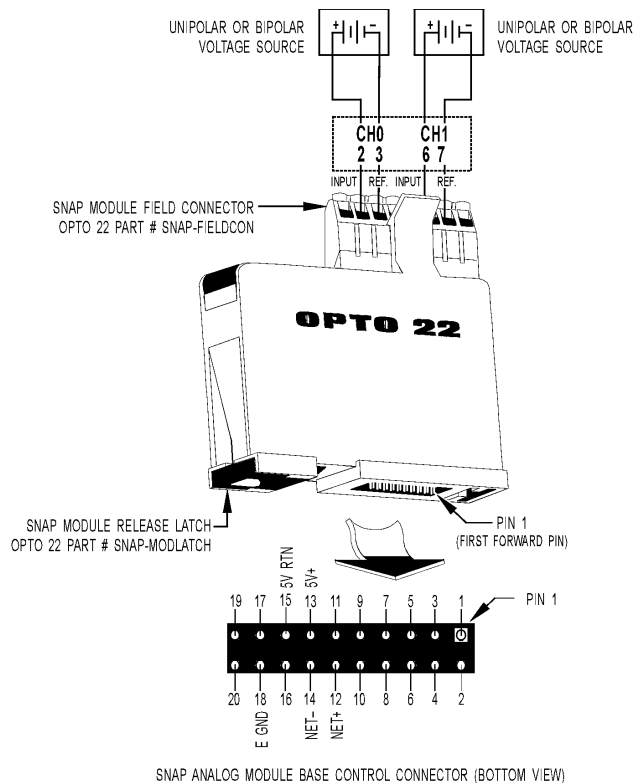

IMPORTANT: The mounting rack connector has 24 pins; the module connector has 20 pins. The extra pins on the mounting rack connector prevent misalignment of the module during installation.

Description

The SNAP-AIV-i module can be configured for either -10 VDC to +10 VDC or -5 VDC to +5 VDC operation on each channel. The SNAP-AIV-i provides two channels that are isolated from each other. Since these channels do not share any common connections, grounded sensors and field devices may be used with them.

Part Number	Description
SNAP-AIV-i	Isolated two-channel analog voltage input -10 VDC to +10 VDC or -5 VDC to +5 VDC

Specifications

Input Range	From -10 volts to +10 volts From -5 volts to +5 volts
Maximum Over Range	$\pm 10\%$ (= ± 27500 counts)
Resolution	0.4 mV when configured -10 volts to +10 volts 0.2 mV when configured -5 volts to +5 volts
Input Filtering	-3 dB @ 64 Hz
Input Response Time (% of span/ DV / Dt)	63.2% / 6.7 V / 10 mS
DC Common Mode Rejection	>-120 dB
AC Common Mode Rejection	>-120 dB @ 60 Hz
Maximum Survivable Input	220 VAC or 300 VDC
Maximum Operating Common Mode Voltage	250 V
Accuracy	0.05%, 5 mV @ 10 VDC 2.5 mV @ 5 VDC
Gain Temperature Coefficient	30 PPM/ °C
Offset Temperature Coefficient	15 PPM/ °C
Isolation: Optical	4000 V
Isolation: Transformer	1500 V
Isolation: Channel to Channel	250 V continuous (1500 V transient)
Power Requirements	5 VDC (± 0.15) @ 200 mA
Input Resistance	1 megohms (each channel)
Torque, hold-down screws	4 in-lb (0.45 N-m)
Torque, connector screws	5.26 in-lb (0.6 N-m)
Agency Approvals	CE, FM, RoHS, DFARS
Warranty	Lifetime

SNAP Isolated Analog Input Modules

Isolated Voltage Input Module -100 VDC to +100 VDC or -50 VDC to +50 VDC

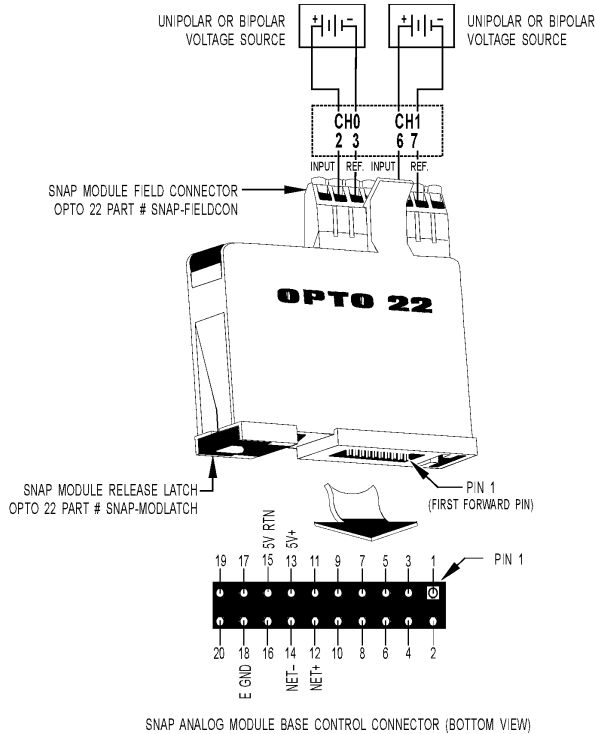

IMPORTANT: The mounting rack connector has 24 pins; the module connector has 20 pins. The extra pins on the mounting rack connector prevent misalignment of the module during installation.

Description

The SNAP-AIV2-i module can be configured for either -100 VDC to +100 VDC or -50 VDC to +50 VDC operation on each channel. The SNAP-AIV2-i provides two channels that are isolated from each other. Since these channels do not share any common connections, grounded sensors and field devices may be used with them.

Part Number	Description
SNAP-AIV2-i	Isolated two-channel analog voltage input -100 VDC to +100 VDC or -50 VDC to +50 VDC

Specifications

Input Range	From -100 volts to +100 volts From -50 volts to +50 volts
Maximum Over Range	± 10% (= ± 27500 counts)
Resolution	4.0 mV when configured -100 volts to +100 volts 2.0 mV when configured -50 volts to +50 volts
Input Filtering	-3 dB @ 64 Hz
Input Response Time (% of span/ DV / Dt)	63.2% / 6.7 V / 10 mS
DC Common Mode Rejection	>-120 dB
AC Common Mode Rejection	>-120 dB @ 60 Hz
Maximum Survivable Input	220 VAC or 300 VDC
Maximum Operating Common Mode Voltage	250 V
Accuracy	0.05%, 50 mV @ 100 VDC 25 mV @ 50 VDC
Gain Temperature Coefficient	30 PPM/ °C
Offset Temperature Coefficient	15 PPM/ °C
Isolation: Optical	4000 V
Isolation: Transformer	1500 V
Isolation: Channel to Channel	250 V continuous (1500 V transient)
Power Requirements	5 VDC (±0.15) @ 200 mA
Input Resistance	1 megohms (each channel)
Ambient Temperature: Operating Storage	0 °C to 70 °C -25 °C to 85 °C
Torque, hold-down screws	4 in-lb (0.45 N-m)
Torque, connector screws	5.26 in-lb (0.6 N-m)
Agency Approvals	CE, RoHS, DFARS
Warranty	Lifetime

SNAP Isolated Analog Input Modules

Dimensional Drawing

All Modules Except SNAP-AITM-i, SNAP-AITM2-i, SNAP-AITM-4i, SNAP-AIMA-iSRC, and SNAP-AIMA-iSRC-FM

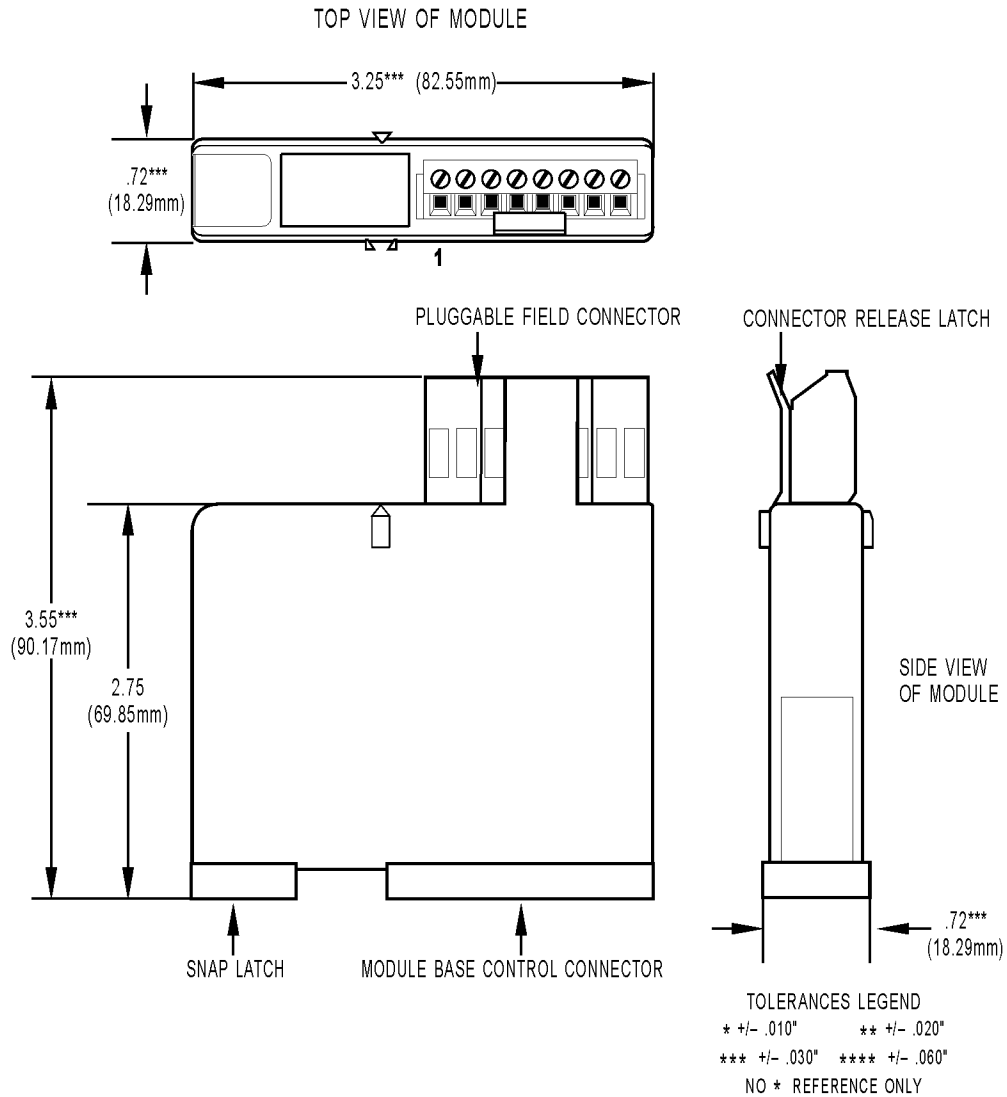

SNAP Isolated Analog Input Modules

Dimensional Drawing

SNAP-AITM-i and SNAP-AITM2-i Modules

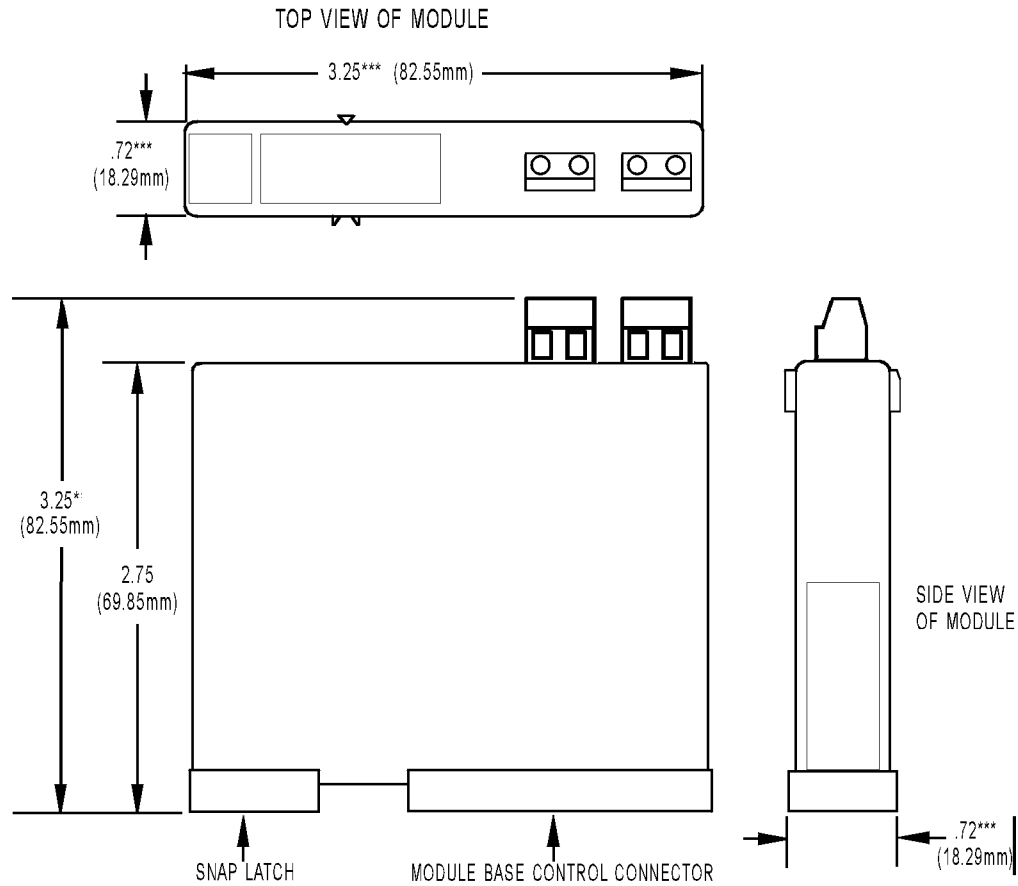

TOLERANCES LEGEND
 * +/- .010" ** +/- .020"
 *** +/- .030" **** +/- .060"
 NO * REFERENCE ONLY

SNAP Isolated Analog Input Modules

Dimensional Drawing

SNAP-AITM-4i Module

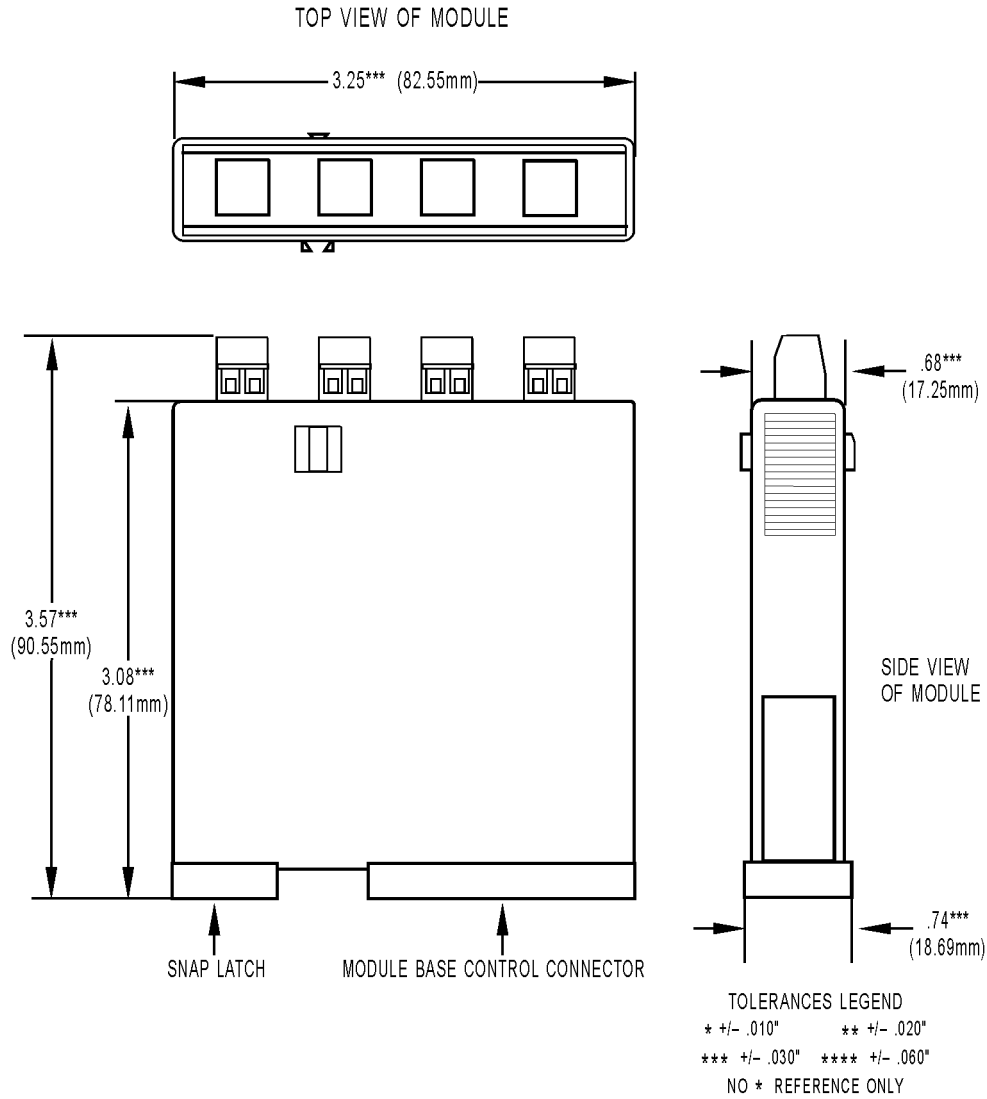

SNAP Isolated Analog Input Modules

Dimensional Drawing

SNAP-AIMA-iSRC and SNAP-AIMA-iSRC-FM Modules

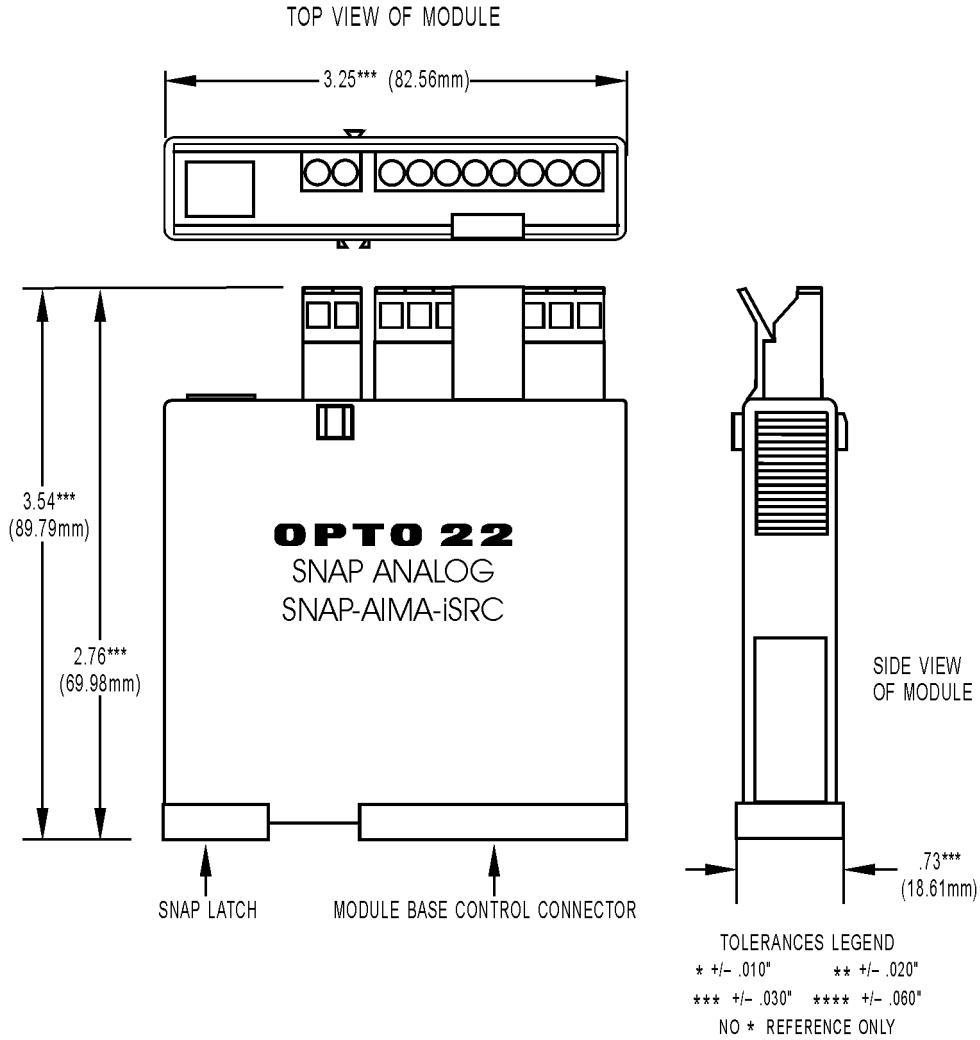

SNAP Isolated Analog Input Modules

Dimensional Drawing

All Modules

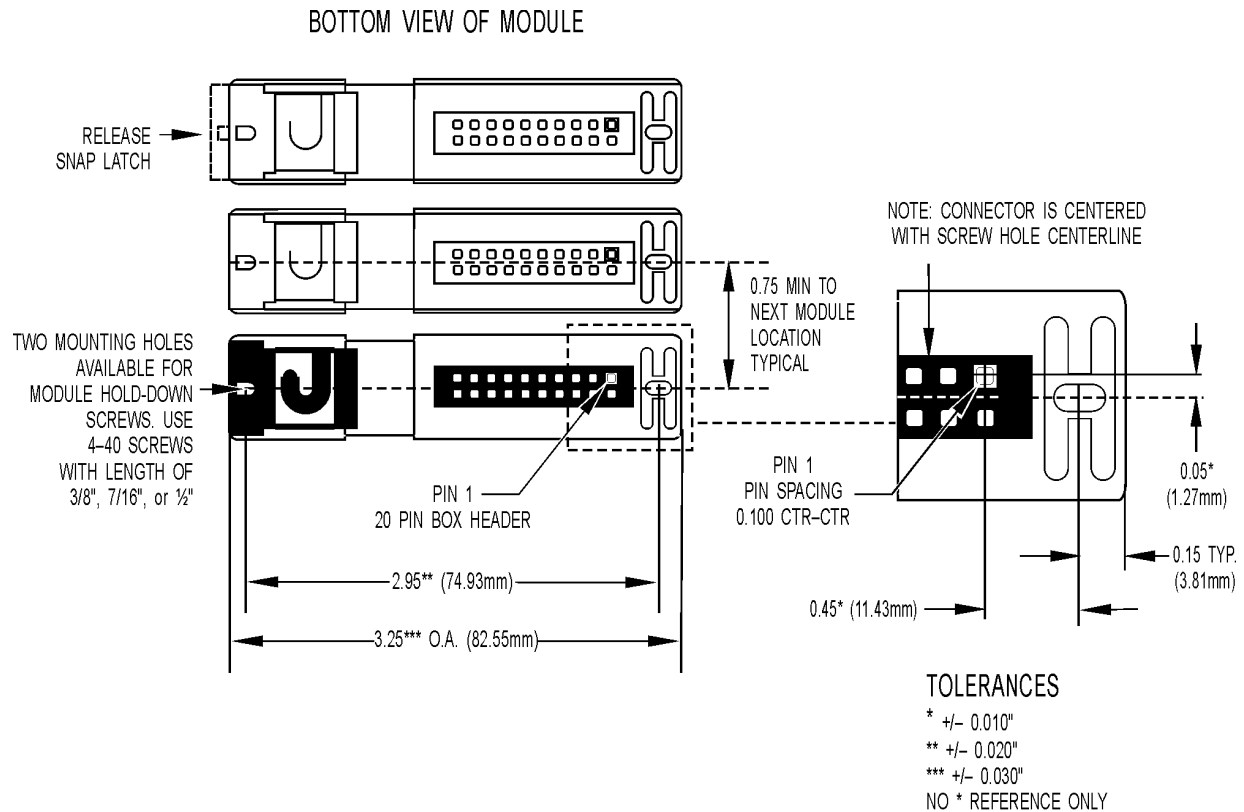

IMPORTANT: The mounting rack connector has 24 pins; the module connector has 20 pins. The extra pins on the mounting rack connector prevent misalignment of the module during installation.

SNAP Isolated Analog Input Modules

Dimensional Drawing

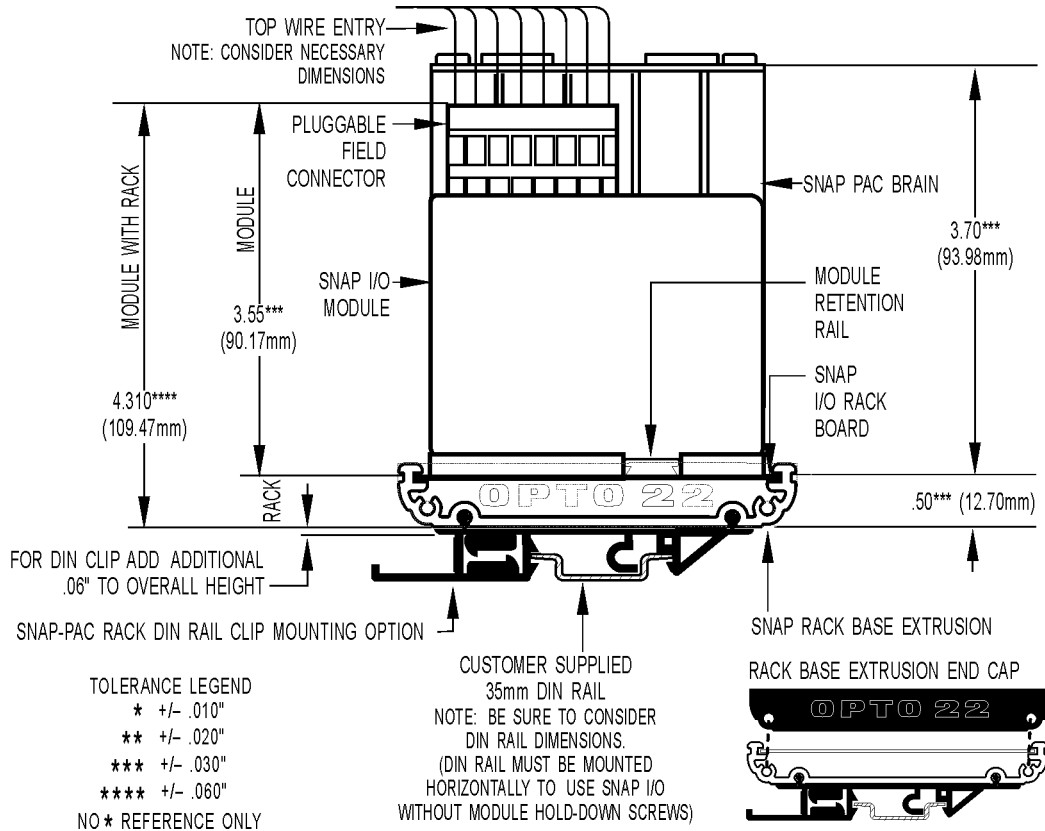

SNAP Isolated Analog Input Modules

Dimensional Drawing

Height on Rack: SNAP-AITMi and SNAP-AITM2-i Modules

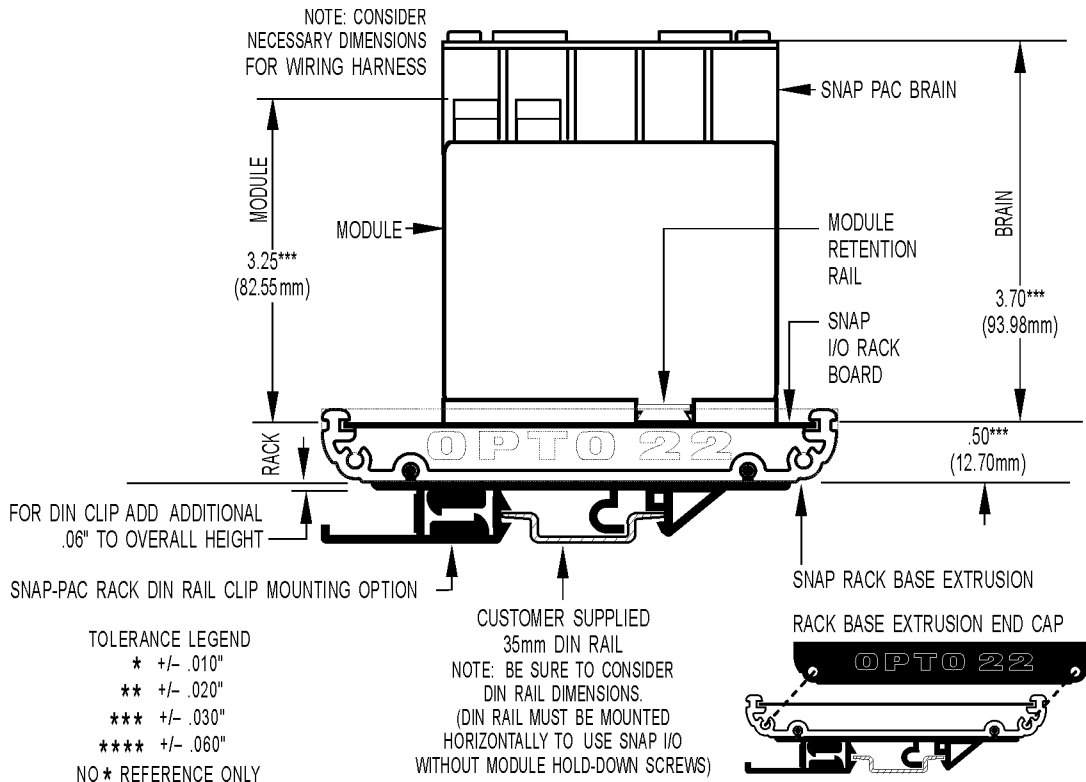

More About Opto 22

Products

Opto 22 develops and manufactures reliable, flexible, easy-to-use hardware and software products for industrial automation, remote monitoring, and data acquisition applications.

SNAP PAC System

Designed to simplify the typically complex process of understanding, selecting, buying, and applying an automation system, the SNAP PAC System consists of four integrated components:

- SNAP PAC controllers
- PAC Project™ Software Suite
- SNAP PAC brains
- SNAP I/O™

SNAP PAC Controllers

Programmable automation controllers (PACs) are multifunctional, multidomain, modular controllers based on open standards and providing an integrated development environment.

Opto 22 has been manufacturing PACs for many years. The latest models include the standalone SNAP PAC S-series and the rack-mounted SNAP PAC R-series. Both handle a wide range of digital, analog, and serial functions and are equally suited to data collection, remote monitoring, process control, and discrete and hybrid manufacturing.

SNAP PACs are based on open Ethernet and Internet Protocol (IP) standards, so you can build or extend a system without the expense and limitations of proprietary networks and protocols.

PAC Project Software Suite

Opto 22's PAC Project Software Suite provides full-featured and cost-effective control programming, HMI (human machine interface) development and runtime, OPC server, and database connectivity software to power your SNAP PAC System.

These fully integrated software applications share a single tagname database, so the data points you configure in PAC Control™ are immediately available for use in PAC Display™, OptoOPCServer™, and OptoDataLink™. Commands are in plain English; variables and I/O point names are fully descriptive.

PAC Project Basic offers control and HMI tools and is free for download on our website, www.opto22.com. PAC Project Professional, available for separate purchase, adds OptoOPCServer, OptoDataLink, options for Ethernet link redundancy or segmented networking, and support for legacy Opto 22 serial *mistic*™ I/O units.

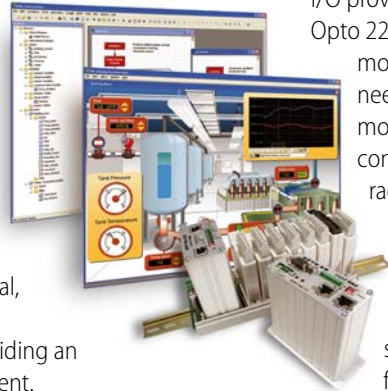

SNAP PAC Brains

While SNAP PAC controllers provide central control and data distribution, SNAP PAC brains provide distributed intelligence for I/O processing and communications. Brains offer analog, digital, and serial functions, including thermocouple linearization; PID loop control; and optional high-speed digital counting (up to 20 kHz), quadrature counting, TPO, and pulse generation and measurement.

SNAP I/O

I/O provides the local connection to sensors and equipment. Opto 22 SNAP I/O offers 1 to 32 points of reliable I/O per module, depending on the type of module and your needs. Analog, digital, serial, and special-purpose modules are all mixed on the same mounting rack and controlled by the same processor (SNAP PAC brain or rack-mounted controller).

Quality

Founded in 1974 and with over 85 million devices sold, Opto 22 has established a worldwide reputation for high-quality products. All are made in the U.S.A. at our manufacturing facility in Temecula, California. Because we do no statistical testing and each part is tested twice before leaving our factory, we can guarantee most solid-state relays and optically isolated I/O modules for life.

Free Product Support

Opto 22's Product Support Group offers free, comprehensive technical support for Opto 22 products. Our staff of support engineers represents decades of training and experience. Product support is available in English and Spanish, by phone or email, Monday through Friday, 7 a.m. to 5 p.m. PST.

Free Customer Training

Hands-on training classes for the SNAP PAC System are offered at our headquarters in Temecula, California. Each student has his or her own learning station; classes are limited to nine students. Registration for the free training class is on a first-come, first-served basis. See our website, www.opto22.com, for more information or email training@opto22.com.

Purchasing Opto 22 Products

Opto 22 products are sold directly and through a worldwide network of distributors, partners, and system integrators. For more information, contact Opto 22 headquarters at 800-321-6786 or 951-695-3000, or visit our website at www.opto22.com.

www.opto22.com