

**Miniature Series 07
General Purpose Filter/Regulator
1/8" and 1/4" Port Sizes**

- **Compact design**
- **Full flow gauge ports**
- **Low torque, non-rising adjusting knob**
- **Snap action knob locks pressure setting when pushed in**
- **Standard relieving models allow reduction of outlet pressure even when the system is dead-ended**
- **Protects air operated devices by removing liquid and solids contaminants**
- **Screw-on bowl reduces maintenance time**
- **Can be disassembled without the use of tools or removal from the air line**

Technical Data

Fluid: Compressed air

Maximum pressure:

Transparent bowl: 10 bar (150 psig)

Metal bowl: 17 bar (250 psig)

Operating temperature:*

Transparent bowl: -20° to +50°C (0° to +125°F)

Metal bowl: -20° to +65°C (0° to +150°F)

* Air supply must be dry enough to avoid ice formation at temperatures below +2°C (+35°F)

Particle removal: 5 µm or 40 µm filter element

Air quality: Within ISO 8573-1, Class 3 and Class 5 (particulates)

Typical flow at 10 bar (100 psig) inlet pressure, 6,3 bar (90 psig) set pressure and a droop of 1 bar (15 psig) from set:

1/8" Ports: 6,2 dm³/s (13 scfm) with 5 µm element

1/4" Ports: 6,5 dm³/s (14 scfm) with 5 µm element

Nominal bowl size: 31 ml (1 fluid ounce)

Gauge ports:

1/8" PTF with PTF main ports

1/8" ISO Rc with ISO Rc main ports

1/8" ISO Rc with ISO G main ports

Drain connection: 1/8" pipe

Automatic drain operation: Spitter type drain operates momentarily when a rapid change in air flow occurs or when the supply pressure is reduced.

Materials:

Body: Zinc

Bonnet: Acetal

Valve: Brass/nitrile

Valve seat: Acetal

Bowl:

Transparent: Polycarbonate

Metal: Zinc

Element: Sintered polypropylene

Elastomers: Nitrile

Ordering Information

See *Ordering Information* on the following pages.

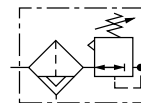
ISO Symbols

Automatic Drain
Relieving

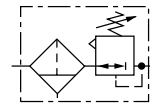

Manual Drain
Relieving

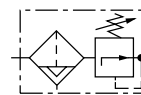

Automatic Drain
Non Relieving

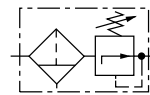

Manual Drain
Non Relieving



Typical Performance Characteristics

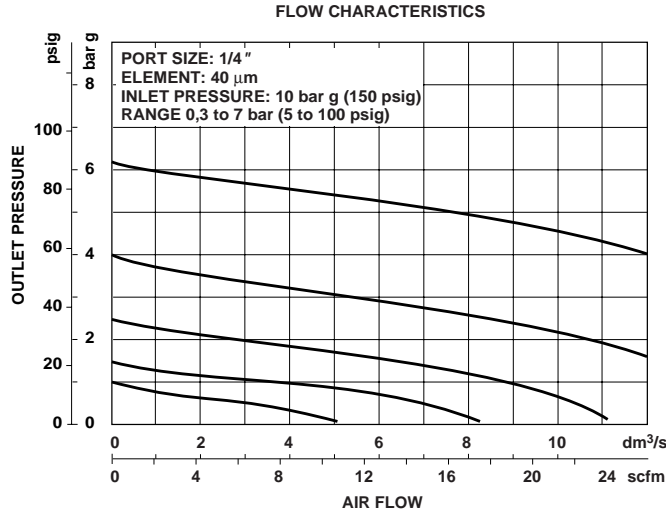

Ordering Information. Models listed include ISO G threads, transparent bowl, relieving diaphragm, automatic drain, 40 µm element, 0,3 to 7 bar (5 to 100 psig) outlet pressure adjustment range* .

Port Size	Model Number	Flow† dm³/s (scfm)	Weight kg (lbs)
G1/8	B07-101-A3KG	6,2 dm³/s (13)	0,26 (0.57)
G1/4	B07-201-A3KG	6,5 dm³/s (14)	0,26 (0.57)

† Typical flow with 7 bar (100 psig) inlet pressure, 6,3 bar (90 psig) set pressure and a 1 bar (15 psig) droop from set.

Alternative Models

B 0 7 - ★ ★ ★ - ★ ★ ★ ★

Port Size	Substitute
1/8"	1
1/4"	2

Bowl	Relief Type	Gauge	Substitute
Transparent	Relieving	Without	01
Transparent	Non relieving	Without	03
Metal	Relieving	Without	33
Metal	Non relieving	Without	35
Metal	Relieving	Without	05**
Metal	Non relieving	Without	07**

* Outlet pressure can be adjusted to pressures in excess of, and less than, those specified. Do not use these units to control pressures outside of the specified ranges.

** When specifying 10 bar (150 psig) unit, eg. B07-205-A3MG, also note correct code at 5th and 6th digits.

Threads	Substitute
PTF	A
ISO Rc taper	B
ISO G parallel	G

Outlet Pressure Adjustment Ranges*	Substitute
0.1 to 0.7 bar (1 to 10 psig)	A
0.3 to 3.5 bar (5 to 50 psig)	E
0.3 to 7 bar (5 to 100 psig)	K
0.3 to 10 bar (5 to 145 psig)	M**

Element	Substitute
5 µm	1
40 µm	3

Drain	Substitute
Automatic	A
Manual	M

Accessories

Wall Mounting Bracket and Panel Nut for P1H Unit	Panel Nut	Tamper Resistant Field Modification	Ø 40 mm Pressure Gauge	R1/8 Connection	1/8" PTF Connection
Plastic: 18-025-003	Plastic: 2962-89 Metal: 2962-04	Knob and screw: 18-001-092 Screw only: 6097-08	2 bar (30 psig): 4 bar (60 psig): 10 bar (150 psig): 25 bar (350 psig):	— 18-013-990 18-013-989 18-013-908	18-013-214 18-013-211 18-013-212 —



Dimensions mm (inches)

Panel mounting hole diameter 30 mm (1.19")
 Panel thickness 0 to 6 mm (0 to 0.25")

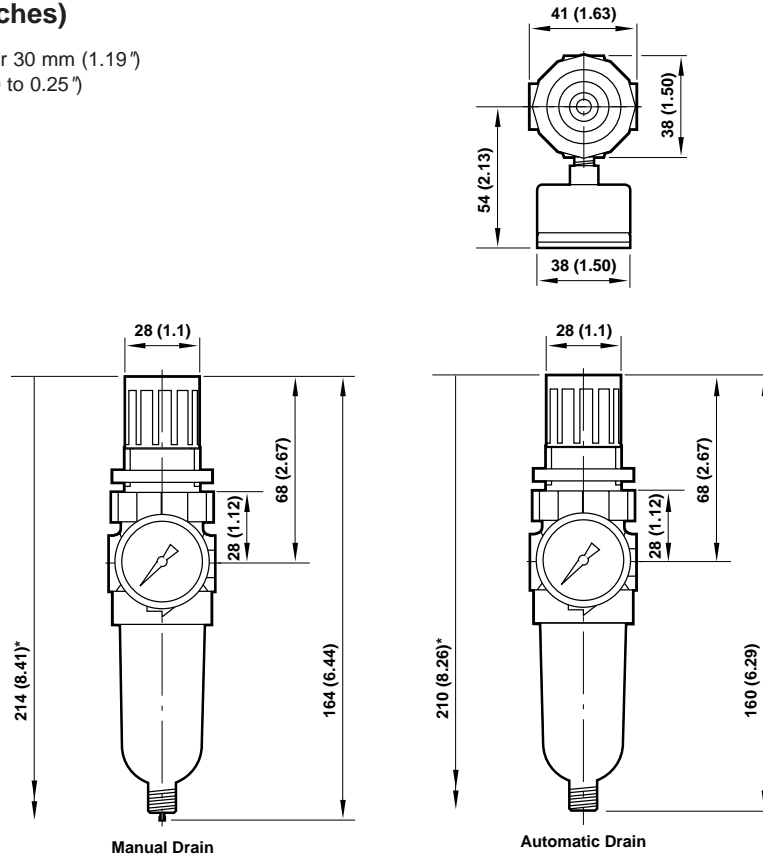

* Minimum clearance to remove bowl

Bracket Mounting

Use 3 mm (1/8") screws to mount bracket to wall.

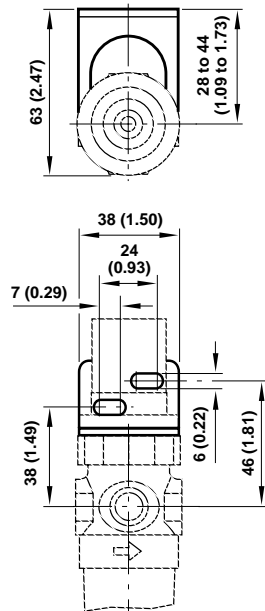

Bracket Kit Reference

Item	Part Number
All models	18-025-003

Service Kits

Item	Type	Part number
Service kit	Relieving models, 40 µm element	3820-14
	Non relieving models, 40 µm element	3820-13
Replacement drains	Manual	773-03
	Automatic	3654-02

Service kit includes slip ring, diaphragm, valve seat with o-ring, valve, valve spring, element, element gasket, and bowl o-ring.



Warning

These products are intended for use in industrial compressed air systems only. Do not use these products where pressures and temperatures can exceed those listed under '**Technical Data**'.

Before using these products with fluids other than those specified, for non-industrial applications, life-support systems, or other applications not within published specifications, consult NORGREN.

Through misuse, age, or malfunction, components used in fluid power systems can fail in various modes. The system designer is warned to consider the failure modes of all component parts used in fluid power systems and to provide adequate safeguards to prevent personal injury or damage to equipment in the event of such failure.

System designers must provide a warning to end users in the system instructional manual if protection against a failure mode cannot be adequately provided.

System designers and end users are cautioned to review specific warnings found in instruction sheets packed and shipped with these products.

Water vapor will pass through these units and will condense into liquid if air temperature drops in the downstream system. Install an air dryer if water condensation could have a detrimental effect on the application.