



IVO IRION & VOSSELER
 GMBH & CO
 P.O. Box 33 60
 D-7730 VS-SCHWENNINGEN
 TELEPHONE: (0 77 20) 6 99-1
 TELETEX: 772 016 - IVOVS
 TELEFAX: 6 99-212

Product Information

Miniature Electromagnetic Impulse Counter F 703

472-256/268/270

F 703
 6.91

Features

- Electromagnetic totalizing counter for DC
- 7-figure capacity, non-reset
- Small dimensions
- Dust and water-protected
- Low power consumption
- Insensitive to external magnetic fields
- Suitable for automatic soldering to PC boards
- Optional front or top reading

Applications

These totalizing counters suit all applications where pieces, units of time, energy, volume, money etc. are to be counted.

Typical examples of application are copying machines, gambling and vending machines, devices for measuring heat, or the monitoring of guarantee periods of machines and appliances.

These miniature counters are also available as B 703 elapsed time meters (see Product Information B 703).

Technical Data

Counting mode	1 impulse = 1 count adding in 2 half-steps
Display and capacity	7 digits 9999999 When the max. counting capacity is reached, the counter starts at zero again.
Figures	1.2 x 4 mm high white on black
Count speed max.	10 i.p.s.
Life expectancy	approx. 10 million counts
Ambient temperature	-20° C to + 70° C
Counter reading on delivery	0 000 002 (standard)
Housing	transparent plastic material
Weight	approx. 10 g
Electrical connection	by flying leads approx. 140 mm long by soldering pins 0.6 mm dia.

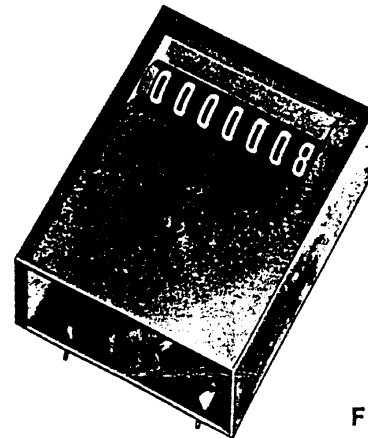

F 703.70B

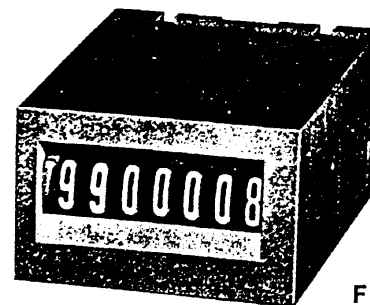

F 703.70C

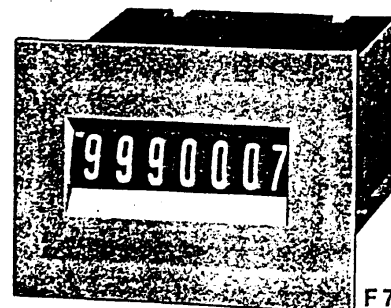

F 723.70D

Ordering information

1. Model and configuration (e.g. F 723.70C)
2. Voltage

Models

Fixing	Front dimensions W. x H. mm	Reading	Protection DIN 40050	Electrical Connection	Model and Configuration
PCB Soldering pins	25 x 13,5	from front	IP 65	soldering pins at top	F 703.70 A
	25 x 31	from top	IP 65	soldering pins at bottom	F 703.70 B
Rear Stud Fixing	25 x 13,8	from front	IP 31	soldering pins at bottom	F 703.70 C
				leads at rear	F 703.70 D
Front panel (fixing by spring locking tongues)	30 x 20	from front	IP 31	soldering pins at rear	F 723.70 C
				leads at rear	F 723.70 D

Electrical data

Voltage $\pm 10\%$ Ripple factor $\leq 5\%$	Power consumption	Min. On-time	Min. Off-time	Mark space ratio	Duty cycle at 25°C
1 V	250 mW	} 50 ms	50 ms	1 : 1	100%
2.5 V	250 mW				
5 V	250 mW				
12 V	250 mW				
24 V	460 mW				

Dimensions

F 703.70A reading from front
soldering pins at top

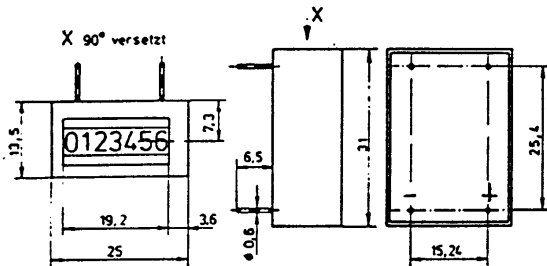

F 703.70B reading from top
soldering pins at bottom

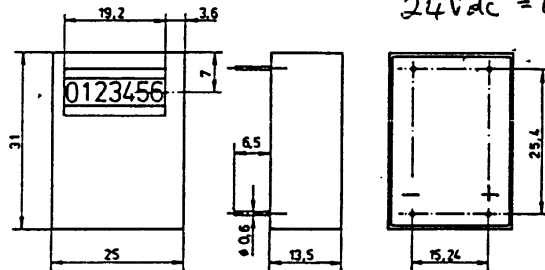

$$\begin{aligned} 5V_{dc} &= 472 - 256 \\ 12V_{dc} &= 472 - 268 \\ 24V_{dc} &= 472 - 270 \end{aligned}$$

F 703.70C Rear Stud Fixing
soldering pins rear

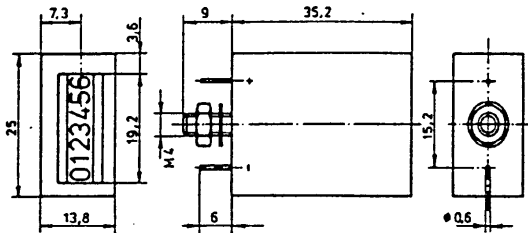

F 703.70D Rear Stud Fixing
leads at rear

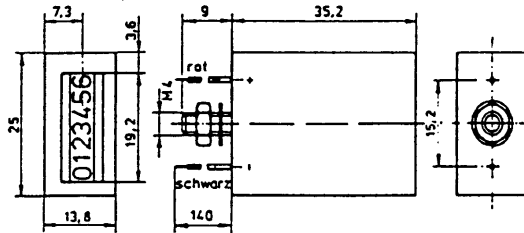

F 723.70C Front panel
pins at rear

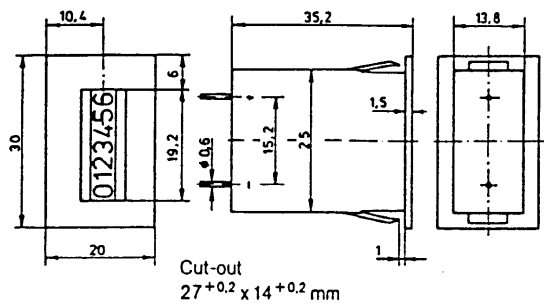

F 723.70D Front panel
leads at rear

