

### Preset and Totalizing Counters with Up to 8-Digit LED Displays

- Draw-out construction allows setting, servicing without disconnecting wiring
- Choose from selectable UP/DOWN or reversible counting
- Large, easy-to-read 8 mm (0.3 in) LED displays — choose 2, 4, 6 or 8 digits
- Contact and solid-state outputs available
- Sustained and adjustable one-shot outputs
- Built-in DC power supply for input devices
- 10-year lithium battery memory backup available
- Panel-mounting hardware included



## Ordering Information

Add the supply voltage to the part number when you order. For example, **H7AN-4DM-AC100-240**.

### ■ PRESET COUNTERS

| Counting method    |               | UP or DOWN (selectable) |                        | Reversible       |                  | UP/DOWN and Reversible |                  |                   |
|--------------------|---------------|-------------------------|------------------------|------------------|------------------|------------------------|------------------|-------------------|
| Memory backup      |               | Not provided            | Provided               | Not provided     | Provided         | Not provided           | Provided         |                   |
| <b>Part number</b> | 2 digits      | Single preset           | <b>H7AN-2D</b>         | <b>H7AN-2DM</b>  | <b>H7AN-E2D</b>  | <b>H7AN-E2DM</b>       | —                | —                 |
|                    |               | Double preset           | <b>H7AN-W4D</b>        | <b>H7AN-W4DM</b> | <b>H7AN-WE4D</b> | <b>H7AN-WE4DM</b>      | —                | —                 |
|                    | 4 digits      | Single preset           | <b>H7AN-4D</b>         | <b>H7AN-4DM</b>  | <b>H7AN-E4D</b>  | <b>H7AN-E4DM</b>       | —                | —                 |
|                    |               | Double preset           | <b>H7AN-W4D</b>        | <b>H7AN-W4DM</b> | <b>H7AN-WE4D</b> | <b>H7AN-WE4DM</b>      | —                | —                 |
|                    | 6 digits      | Single preset           | —                      | —                | —                | —                      | <b>H7AN-R6D</b>  | <b>H7AN-R6DM</b>  |
|                    |               | Double preset           | —                      | —                | —                | —                      | <b>H7AN-RW6D</b> | <b>H7AN-RW6DM</b> |
| 8 digits           | Single preset | —                       | —                      | —                | —                | <b>H7AN-R8D</b>        | <b>H7AN-R8DM</b> |                   |
| Supply voltages    |               | AC                      | 100 to 240 V, 50/60 Hz |                  |                  |                        |                  |                   |
|                    |               | DC                      | 12 to 24 V             |                  |                  |                        |                  |                   |

### ■ TOTALIZING COUNTERS

| Counting method    |          | UP or DOWN (selectable) |                        | Reversible      |                  | UP/DOWN and Reversible |                  |
|--------------------|----------|-------------------------|------------------------|-----------------|------------------|------------------------|------------------|
| Memory backup      |          | Not provided            | Provided               | Not provided    | Provided         | Not provided           | Provided         |
| <b>Part number</b> | 4 digits | <b>H7AN-T4</b>          | <b>H7AN-T4M</b>        | <b>H7AN-ET4</b> | <b>H7AN-ET4M</b> | —                      | —                |
|                    | 6 digits | —                       | —                      | —               | —                | <b>H7AN-RT6</b>        | <b>H7AN-RT6M</b> |
|                    | 8 digits | —                       | —                      | —               | —                | <b>H7AN-RT8</b>        | <b>H7AN-RT8M</b> |
| Supply voltages    |          | AC                      | 100 to 240 V, 50/60 Hz |                 |                  |                        |                  |
|                    |          | DC                      | 12 to 24 V             |                 |                  |                        |                  |

### ■ REPLACEMENT PARTS

| Description   | Part number                |
|---|----------------------------|
| Plastic front cover   | <b>H5AN COVER 033762-0</b> |
| Mounting bracket (one pair supplied with each timer); order two | <b>Y92H-5</b>              |

# Specifications

## ■ GENERAL CAPABILITIES

|                      |   |   |                    |
|----------------------|---|---|--------------------|
| Model                | H7AN  |   | H7AN-T             |
| Classification       | Preset counter  |   | Totalizing counter |
| Mounting             | Panel mounting; two mounting brackets included  |   |                    |
| External connections | Back-mounted screw terminals  |   |                    |
| Output modes         | 2 sustained, 5 one-shot output modes<br>N, F, C, R, K, P, and Q; DIP switch selected  |   | —                  |
| Input modes          | UP or DOWN (DIP switch selectable) for 2- and 4-digit models (H7AN-□□)<br>Reversible for 2- and 4-digit models (H7AN-E□□)<br>UP/DOWN and Reversible for 6- and 8-digit models (H7ANR□□)<br>6 Reversible modes include:<br>Mode A (command inputs L→H), Mode B (individual inputs L→H), Mode C (phase difference inputs L→H), Mode D (command inputs H→L), Mode E (individual inputs H→L) and Mode F (phase difference inputs H→L) |   |                    |
| Reset system         | Power-OFF reset (except those with memory protection, H7AN-M)<br>Minimum power-OFF time: 0.5 second<br>Reset time following power application: 0.05 second  |   |                    |
|                      | External and manual reset<br>Reset time: 0.02 second  |   |                    |
| Sensor power supply  | 12 VDC, 80 mA ±10% (5% max. ripple)   |   |                    |
| Input signal         | Count and reset   |   |                    |
| Input method         | No-voltage input, by short-circuiting or opening contacts<br>Solid-state logic voltage  |   |                    |
| Control outputs      | Single preset   | One SPDT contact and one solid-state open collector output      | No outputs         |
|                      | Double preset   | Two SPST-NO contacts and two solid-state open collector outputs |                    |
| Displays             | 7-segment LED count value display, 8 mm (0.3 in) high characters, and LED indicators for count up and reset   |   |                    |
| Digits               | 2, 4, 6, or 8 digits  |   | 4, 6, or 8 digits  |
| Memory backup        | H7AN-M models have a 3-volt lithium battery that provides 10 years of memory retention at 20°C (68°F)   |   |                    |

## ■ OUTPUT MODES SUMMARY

Preset counters have outputs; totalizing counters H7AN-T do not have outputs.

| Output mode | Description                       |   | Applicable counters       |
|-------------|-----------------------------------|---|---------------------------|
|             | Single preset counter             | Double preset counter   |                           |
| N           | Sustained output                  | Sustained output 2, selectable sustained or one-shot output 1 | H7AN preset counters only |
| F           | Sustained output, overrun display | Sustained output 2, selectable sustained or one-shot output 1 |                           |
| C           | One-shot output                   | One-shot output 2, selectable one-shot or sustained output 1  |                           |
| R           | One-shot output, overrun display  | One-shot output 2, selectable one-shot or sustained output 1  |                           |
| K           | One-shot output                   | One-shot output 2, selectable one-shot or sustained output 1  |                           |
| P           | One-shot output                   | One-shot output 2, selectable one-shot or sustained output 1  |                           |
| Q           | One-shot output, overrun display  | One-shot output 2, selectable one-shot or sustained output 1  |                           |

One-shot period is adjustable from 0.1 to 1.0 second using a front-panel potentiometer.

## ■ RATINGS

|                                 |   |  |
|---------------------------------|---|--|
| Supply voltage                  | 100 to 240 VAC, 50/60 Hz<br>12 to 24 VDC  |  |
| Operating voltage range         | 85 to 100% of rated voltage   |  |
| Power consumption               | Approx. 10 VA at 240 VAC, 50 Hz; 5 W at 24 VDC<br>Inrush current is 10 times greater than current during normal operation                             |  |
| Max. counting speeds (CP1, CP2) | See separate table  |  |
| One-shot output                 | Adjustable, 0.1 to 1.0 second for single preset counters<br>Output 1 fixed at 0.5 sec, Output 2 adjustable, 0.1 to 1.0 sec for double preset counters |  |
| Count and reset inputs          | No-voltage contact inputs: Continuity between terminals 9, 10, 11 and 12<br>Solid-state inputs: High +4.5 to +30 VDC; Low 0 to +2 VDC                 |  |
| Control outputs                 | Contact   | 3 A, 250 VAC resistive load (p.f. = 1) |
|                                 | Solid-state   | Open collector, 100 mA, 30 VDC max.    |

## ■ MAXIMUM COUNTING SPEEDS

The maximum counting speeds depend on the number of digits on the counter and the operation mode selected.

| Counter digits |                  | 2      | 4             | 6      | 8      |
|----------------|------------------|--------|---------------|--------|--------|
| Operation mode |                  | All    | N, F, R, K, Q | C, P   | All    |
| Input type     | Command          | 30 cps | 5 kcps        | 3 kcps | 5 kcps |
|                | Individual       | 30 cps | 5 kcps        | 3 kcps | 5 kcps |
|                | Phase difference | 30 cps | 3 kcps        | 3 kcps | 5 kcps |

Note: To select another mode than the present one, select the mode with the internal selector and reset the counter with the external reset signal, power reset or manual reset switch. The counter also can be reset by turning power OFF. Mode selection is not possible with the automatic reset. The selected mode is effective only after the counter is reset.

## ■ MINIMUM PULSE WIDTHS

To ensure proper operation, be certain the input pulse width is of sufficient duration for the counting speed. For H7AN, the ON/OFF ratio is 1:1.

| Counting speed | Pulse width |
|----------------|-------------|
| 30 cps         | 16.70 ms    |
| 3 kcps         | .17 ms      |
| 5 kcps         | .10 ms      |

## ■ CHARACTERISTICS

|                               |                        |   |
|-------------------------------|------------------------|---|
| Ambient operating temperature |                        | -10° to 55°C (14° to 131°F) with no icing   |
| Storage temperature           |                        | -25° to 65°C (-13° to 149°F) with no icing  |
| Ambient operating humidity    |                        | 35 to 85% RH  |
| Insulation resistance         |                        | 100 MΩ min. at 500 VDC between current-carrying terminals and external non-current-carrying metals parts, and between non-continuous contacts.                          |
| Dielectric strength           |                        | 2,000 VAC, 50/60 Hz for 1 minute between current-carrying terminals and non-current-carrying metal parts<br>750 VAC, 50/60 Hz for 1 minute between non-continuous parts |
| Vibration                     | Mechanical durability  | 10 to 55 Hz, 0.75 mm (0.03 in) double amplitude   |
|                               | Malfunction durability | 10 to 55 Hz, 0.5 mm (0.02 in) double amplitude  |
| Shock                         | Mechanical durability  | Approx. 30 G  |
|                               | Malfunction durability | Approx. 10 G  |
| Approvals                     |                        | UL, CSA   |
| Service life                  | Mechanical             | 10 million operations minimum   |
|                               | Electrical             | 100,000 operations minimum at 3 A, 250 VAC with motor load (p.f. = 1)   |
| Weight                        |                        | Approx. 360 g (12.7 oz.)  |

# Engineering Data

## ■ ELECTRICAL SERVICE LIFE

### Motor Load

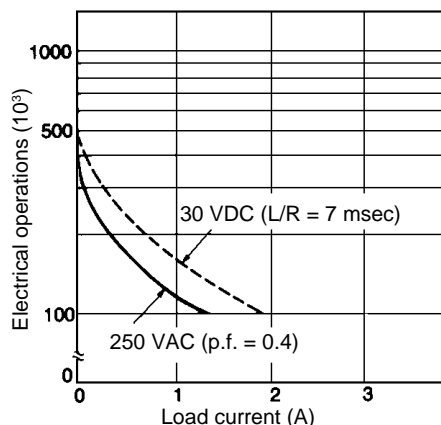

### Resistive Load

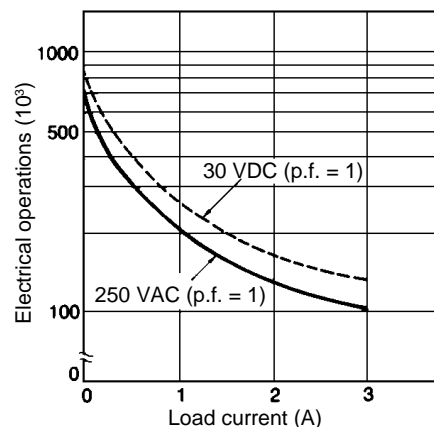

# Timing Charts

## INPUT FUNCTIONS

### UP and DOWN Counters

Preset and totalizing counters have DIP switch selectable counting direction. The graphs below show gate input for count interruption.

The following timing charts combine operations of both single preset and double preset counters. For single preset counters, refer to the 2nd control output.

"A" shows the count input minimum pulse width. If the count input is less than minimum pulse width, a miscount occurs and the count total will be  $\pm 1$  count.

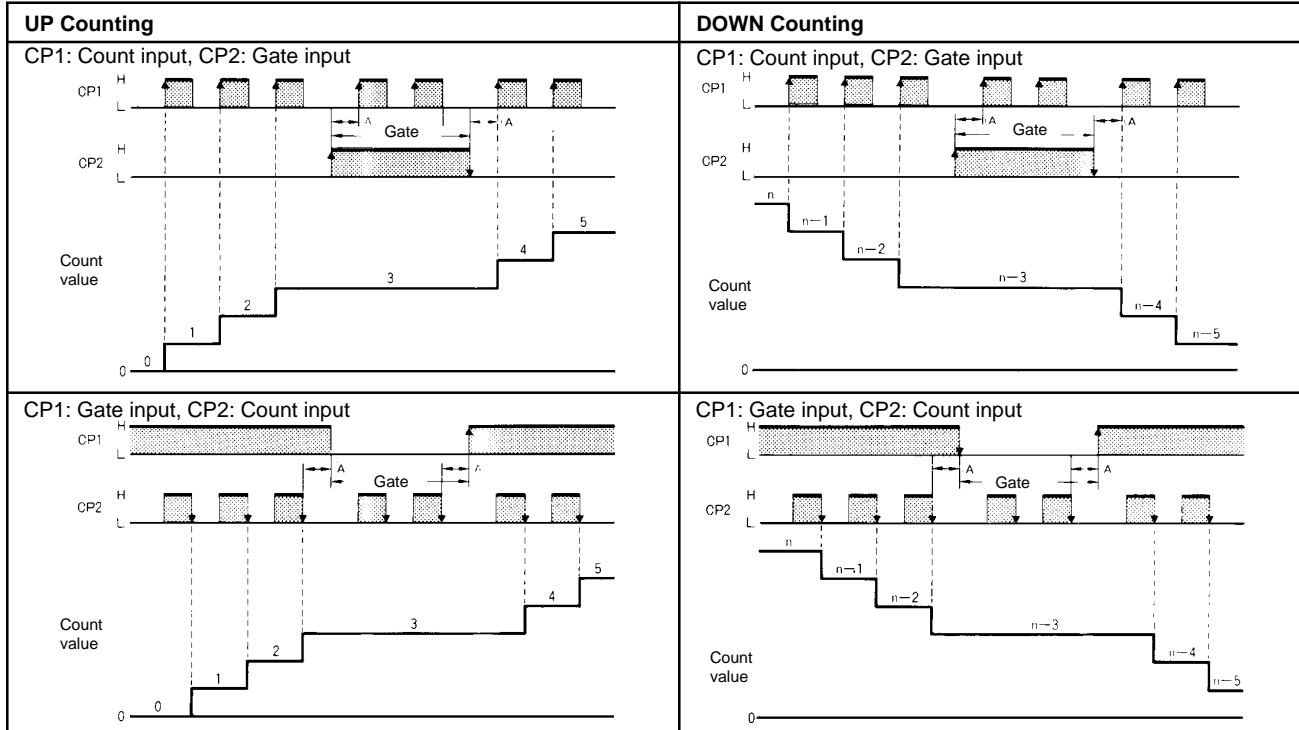

### Reversible Counters

"A" shows the count input minimum pulse width. "B" must be greater than or equal to half the signal or a miscount will occur. In modes C and F, maximum input frequency should equal to CP1 + CP2.

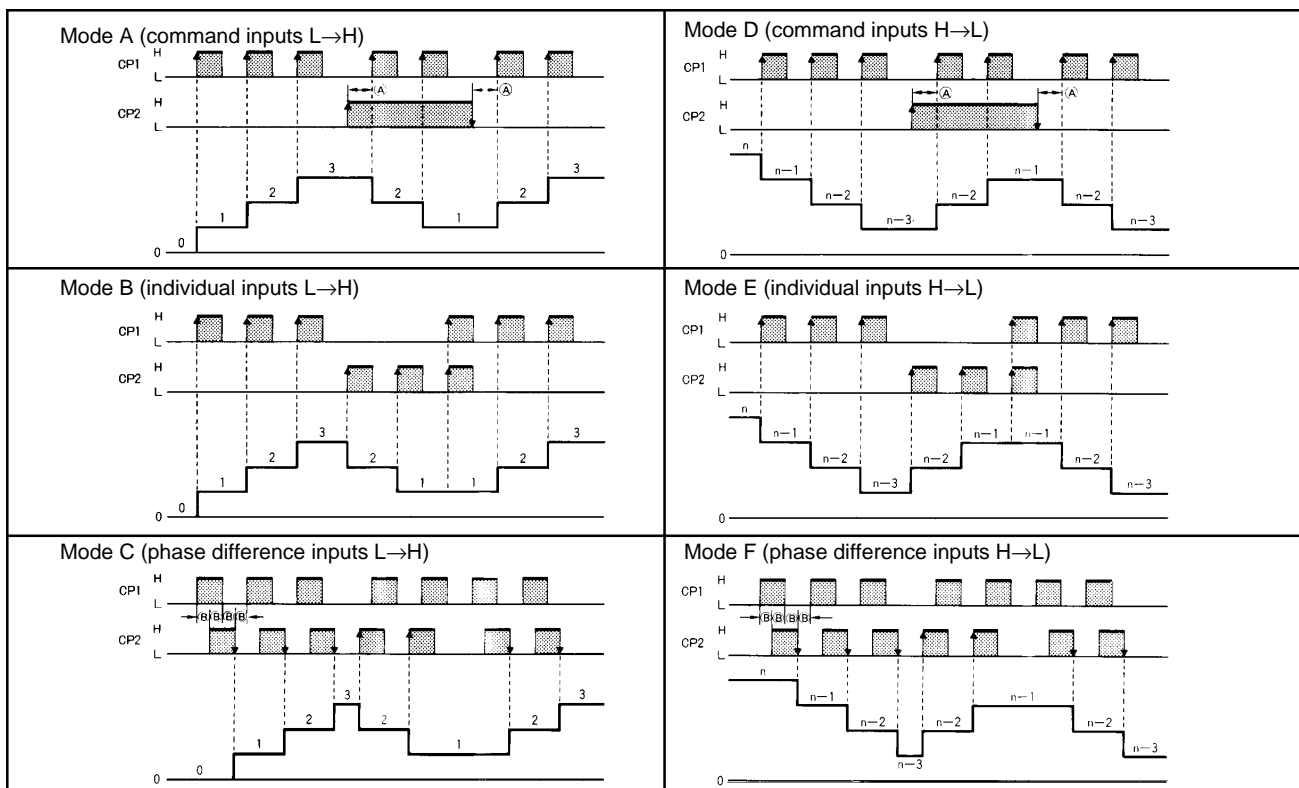

OUTPUT FUNCTIONS

Single Preset Counters

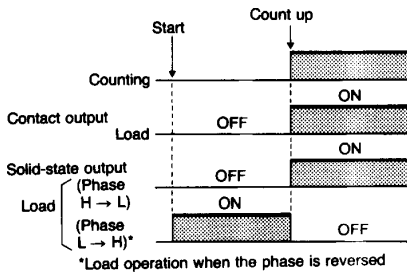

Double Preset Counters

Allow a constant of 5 ms for internal circuitry to complete setting of preset 1 before setting of preset 2 (see table).

| Count speed | Minimum counts required between preset 1 and preset 2 by internal circuitry |
|-------------|---|
| 30 cps      | 1 count   |
| 3 kcps      | 15 counts   |
| 5 kcps      | 25 counts   |

When used as an UP counter:  
 $n - m \geq 5F$   
 Note that  $m \neq n$ .

When used as a DOWN counter:  
 $m \geq 5F$   
 Note that  $m \neq 0$ .

$m$  = preset value 1  
 $n$  = preset value 2  
 $F$  = count speed

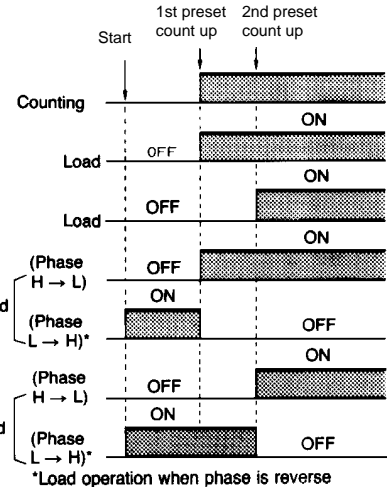

Seven Output Modes for Preset Counters

Modes are selected by internal DIP switch. Refer to "Operation" section and the specific model for details.

In modes C, K, P and Q, do not use the counter so that the count may be up during the one-shot output.

In mode C, the count-up value is not displayed because the internal counting circuit resets as soon as the count is up.

Bold line represents present value; Output 2 operation applies for single-preset models.

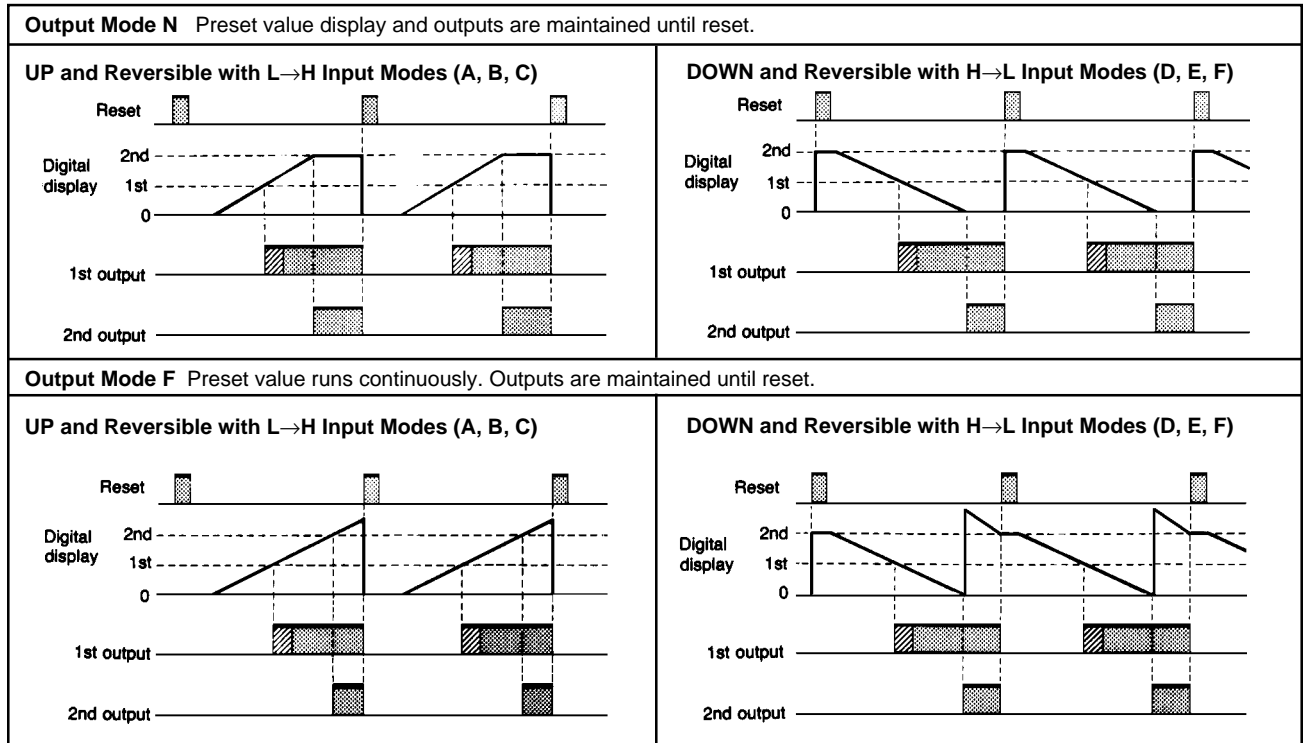

One-shot output 1 in double preset counters is fixed at 0.5 second

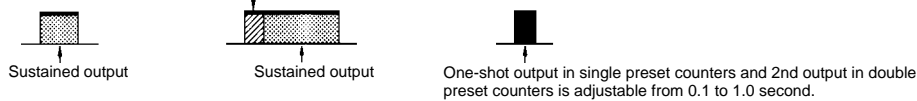

**Counter Output Operation (Continued)**

(Bold line represents present value; Output 2 operation applies for single-preset models.)

**Output Mode C** Preset value is placed in reset start status as soon as preset count is reached; the preset is not actually displayed. Outputs are one-shot and operate repeatedly. Output 1 latches ON, and goes OFF after expiration of the one-shot period for Output 2. One-shot time periods for Output 1 and 2 are independent.

**UP and Reversible with L→H Input Modes (A, B, C)**

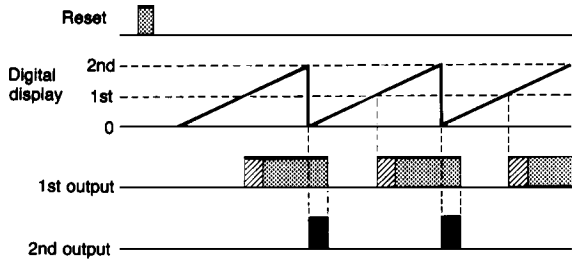

**DOWN and Reversible with H→L Input Modes (D, E, F)**

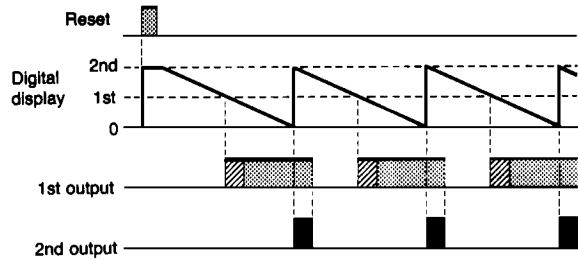

**Output Mode R** Present value display returns to reset start status after expiration of one-shot time period. Outputs are one-shot and operate repeatedly. Output 1 latches ON at preset 1, and goes OFF after expiration of the one-shot period for Output 2. One-shot time periods for Output 1 and 2 are independent.

**UP and Reversible with L→H Input Modes (A, B, C)**

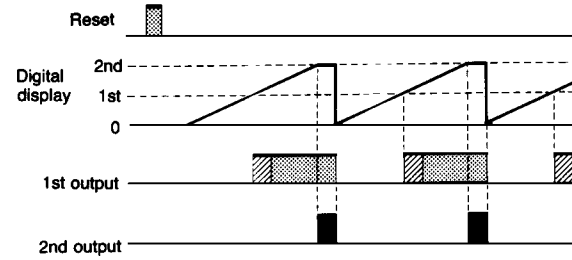

**DOWN and Reversible with H→L Input Modes (D, E, F)**

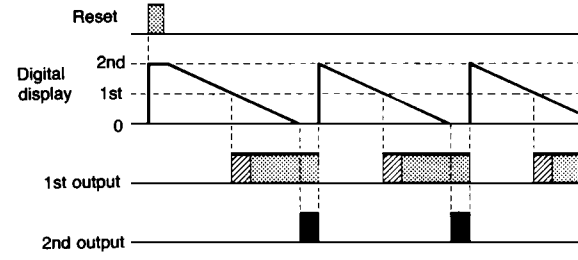

**Output Mode K** Present value runs continuously. Output 1 latches ON at preset 1, and goes OFF after expiration of the one-shot period for Output 2. One-shot time periods for Output 1 and 2 are independent.

**UP and Reversible with L→H Input Modes (A, B, C)**

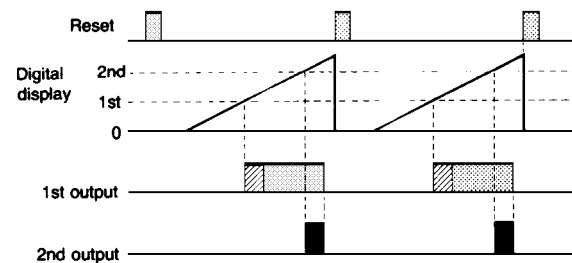

**DOWN and Reversible with H→L Input Modes (D, E, F)**

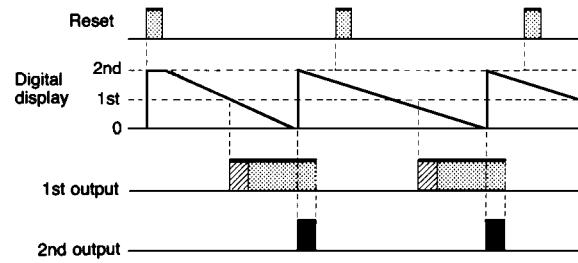

**Output Mode P** Present value display does not change during one-shot time period, but reset start status returns as soon as preset count is reached. Outputs are one-shot and operate repeatedly. Output 1 latches ON at preset 1, and goes OFF after expiration of the one-shot period for Output 2. One-shot time periods for Output 1 and 2 are independent.

**UP and Reversible with L→H Input Modes (A, B, C)**

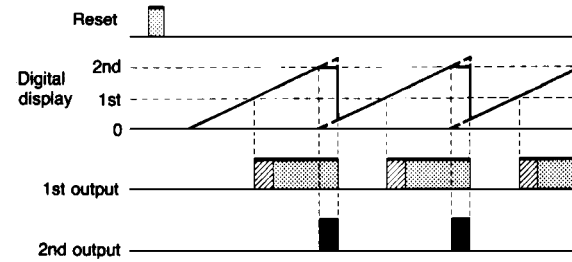

**DOWN and Reversible with H→L Input Modes (D, E, F)**

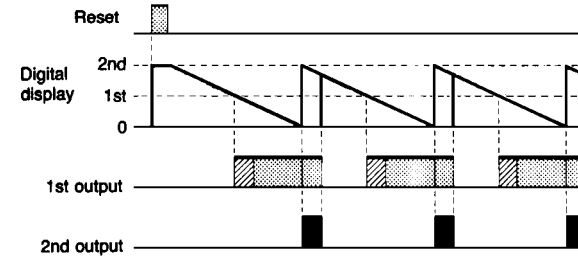

One-shot output 1 in double preset counters is fixed at 0.5 second

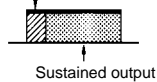
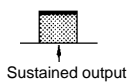

One-shot output in single preset counters and 2nd output in double preset counters is adjustable from 0.1 to 1.0 second.

**Counter Output Operation (Continued)**

(Bold line represents present value; Output 2 operation applies for single-preset models.)

**Output Mode Q** Present value runs continuously through one-shot time period and returns to reset start status immediately afterward. Outputs are one-shot and operate repeatedly. Output 1 latches ON at preset 2, and goes OFF after expiration of the one-shot period for Output 2. One-shot timer periods for Output 1 and 2 are independent.

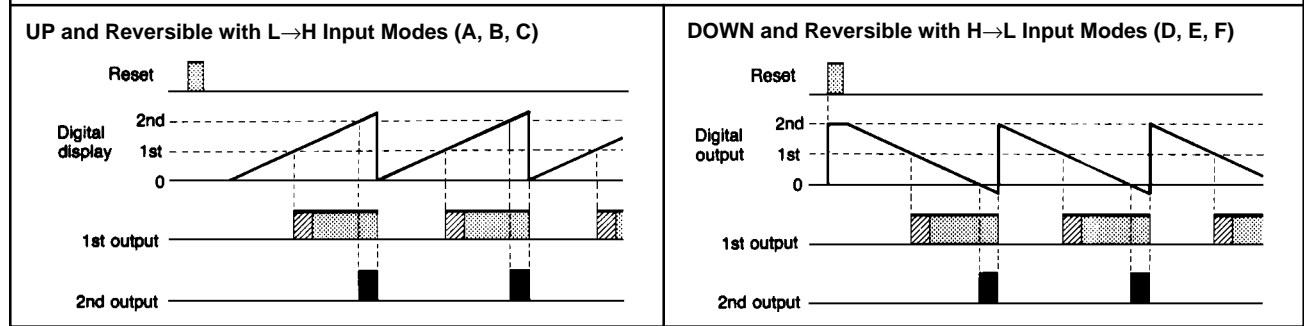

One-shot output 1 in double preset counters is fixed at 0.5 second

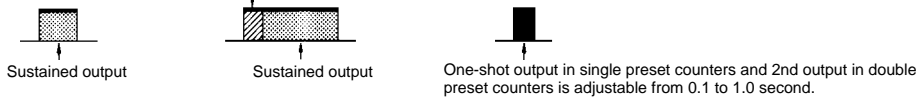

**Dimensions**

Unit: mm (inch)

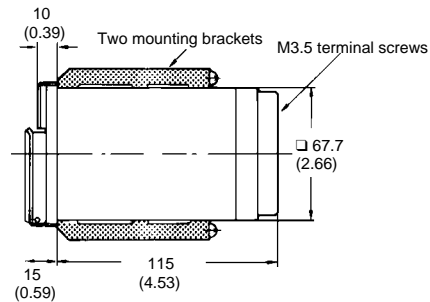
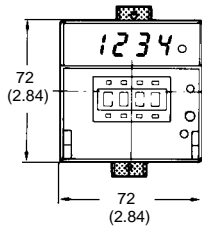
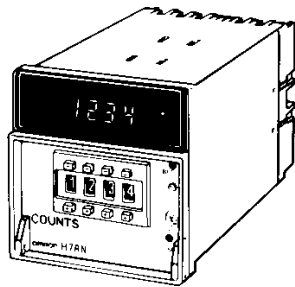

**Panel cutouts**

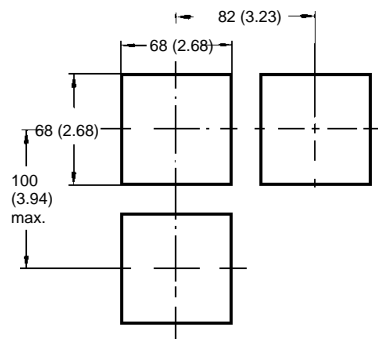

**For side-by-side mounting of two units**

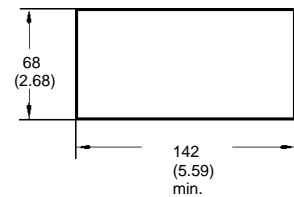

Note:  
Panel cutout conforms to DIN 43700.  
Recommended panel thickness is 1 to 5 mm (0.039 to 0.197 in).

# Connections

### Input terminal number (no voltage only)

|     |       |     |     |
|-----|-------|-----|-----|
| COM | Reset | CP2 | CP1 |
| 8   | 9     | 10  | 11  |

### Power supply terminal numbers

|                  |               |        |
|------------------|---------------|--------|
| AC (common), DC- | AC (hot), DC+ | Ground |
| 1                | 2             | 3      |

### Power supply for externally connected equipment

|                |     |     |
|----------------|-----|-----|
| Voltage supply | DC- | DC+ |
| 12 VDC, 80 mA  | 8   | 12  |

### Output terminal numbers, single preset counter

|             |      |                |
|-------------|------|----------------|
| Contact     |      |                |
| COM         | NO   | NC             |
| 4           | 5    | 6              |
| Solid-state |      |                |
| COM         | Load | Surge absorber |
| 8           | 13   | 14             |

### Output terminal numbers, double preset counter

|             |         |       |
|-------------|---------|-------|
| Contact     |         |       |
| Out 2       | Out 1   |       |
| 4 and 5     | 6 and 7 |       |
| Solid-state |         |       |
| COM         | Out 2   | Out 1 |
| 8           | 13      | 14    |

Note: Totalizing counters do not have outputs.

### Single preset H7AN counters

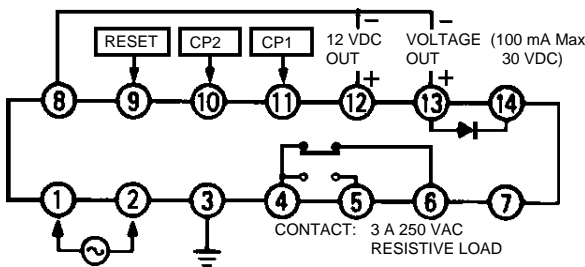

### Double preset H7AN counters

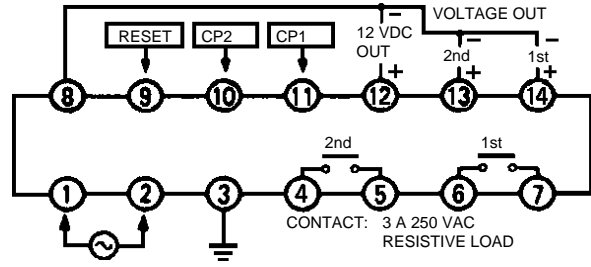

### Single preset counters

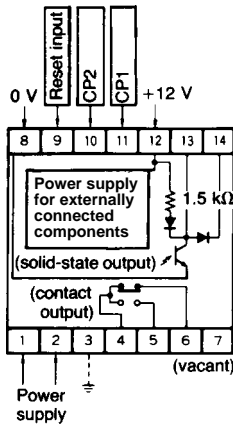

### Double preset counters

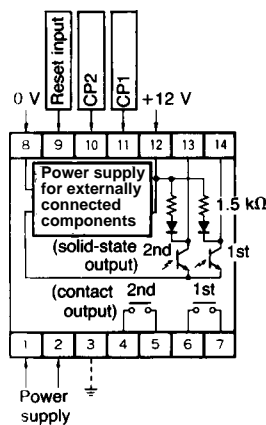

### Totalizing counters

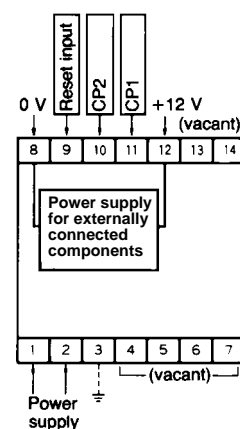

Note:

Do not use the vacant terminals for any purpose.

Ground terminal 3 at a resistance of less than 100 Ω when the counter is used in an environment with high levels of external noise.



■ COUNT AND RESET INPUT CONNECTIONS

Contact inputs

Connect CP1 count input contact between terminals 11 and 12, CP2 count input contact between terminals 9 and 12, respectively. Use a high-reliability contact capable of making and breaking 2.5 mA at 12 VDC. Connect a resistor rated at 680 Ω, 1/2 W between each input terminal and terminal 8 to increase reliability.

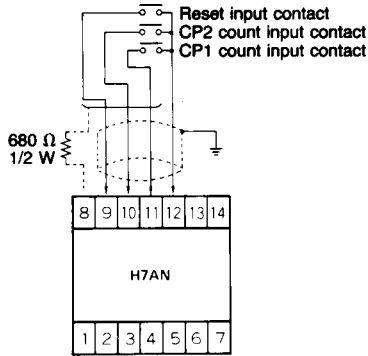

Solid-state inputs

Connect CP1 count input signal voltage between terminals 8 and 11, CP2 count input signal voltage between terminals 8 and 10, and a reset input signal voltage between terminals 8 and 9, respectively. Polarity of terminal 8 becomes (-) common.

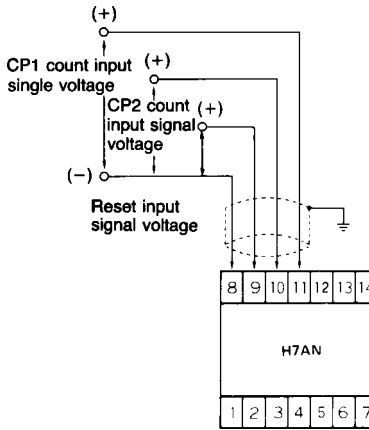

Never apply an input signal at a voltage of 30 V or more. Avoid applying a reverse voltage.

Signal voltage level of solid-state input

When an input signal is applied to the counter at supply voltage E (V) from the load resistance (output resistor R (kΩ) of the transistor Tr in the solid-state circuit, input signal voltage level V becomes high when transistor Tr turns OFF. This "H" level can be calculated by the following equation:

$$H \text{ level of } V = \frac{4.7 E}{4.7 + R} \text{ (V)}$$

Determine the value of R or E properly so that the result of the above equation stays within 5 to 30 V.

In the following diagram, the "L" level of input signal voltage V is governed by the saturation voltage between the collector and emitter of transistor Tr. Generally, the saturation voltage of semiconductor is 1 V or less and the "L" range of 0 to 2 V may be adequately satisfied.

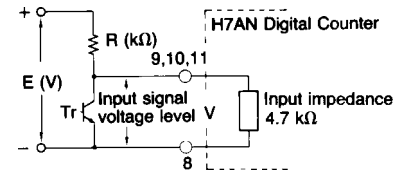

■ POWER SUPPLY CONNECTIONS

Connect the required supply voltage to terminals 1 and 2.

Full supply voltage must be applied all at once to the counter from switches or relays. Gradual application of supply voltage may cause non-power reset or memory change.

When applying a power-OFF reset, be sure to provide a reset signal time (power-OFF time) longer than 0.5 sec.

AC power supply

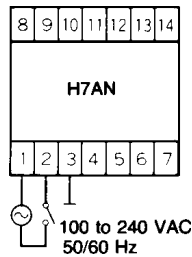

DC power supply

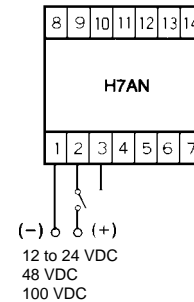

■ POWER SUPPLY FOR EXTERNALLY CONNECTED EQUIPMENT

H7AN counters have a built-in power supply for externally connected components such as sensors for count or reset input, or loads connected to the solid-state control output (12 VDC, 80 mA). Power can be applied to sensors and loads simultaneously.

Single preset counters

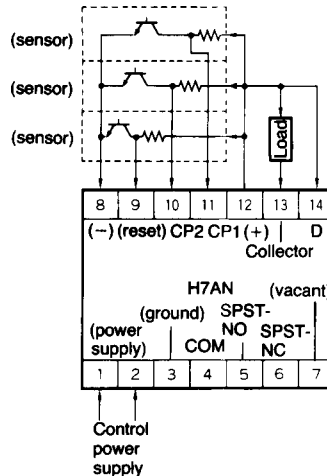

Double preset counters

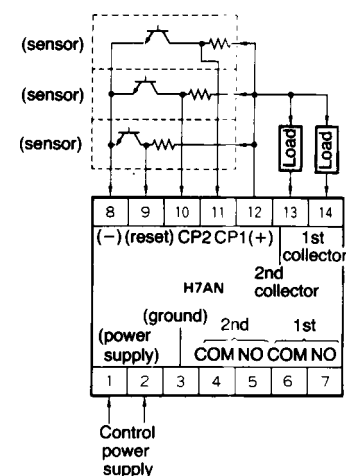

■ OUTPUT LOAD CONNECTIONS

Single preset counters

Terminals 4, 5, and 6 are for contact output while terminals 8 and 13 are for solid-state output. Terminal 14 is connected to absorb the surge if an inductive load is connected. The control outputs of both contact type and solid-state type are available simultaneously.

Contact output load

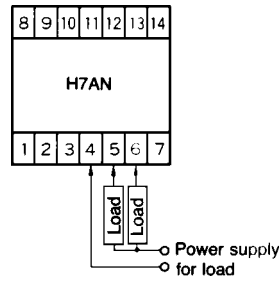

Solid-state output load

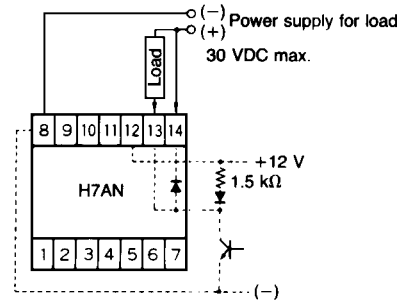

Double preset counter

Terminals 6 and 7 are for the first contact output and terminals 4 and 5 for the second contact output. Terminals 8 and 14 are for the first solid-state output and terminals 8 and 13 are for the second solid-state output. The control outputs of both contact type and solid-state type are available simultaneously.

Contact output load

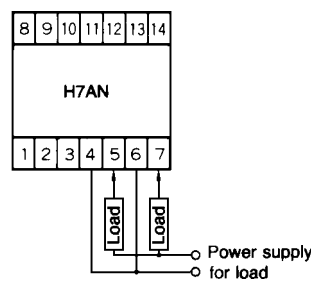

Solid-state output load

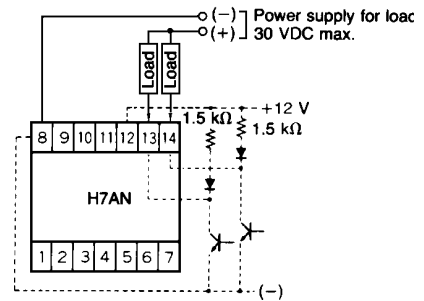

Operation

■ NOMENCLATURE

H7AN-2D, H7AN-2DM, H7AN-E2D, H7AN-E2DM

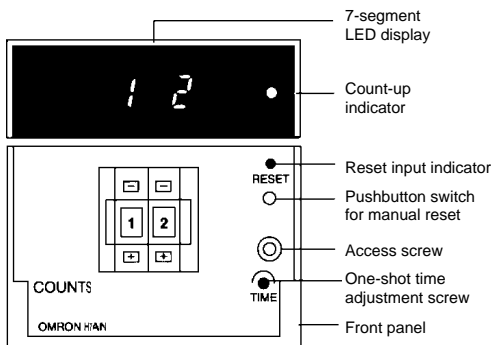

H7AN-4D, H7AN-4DM, H7AN-E4D, H7AN-E4DM

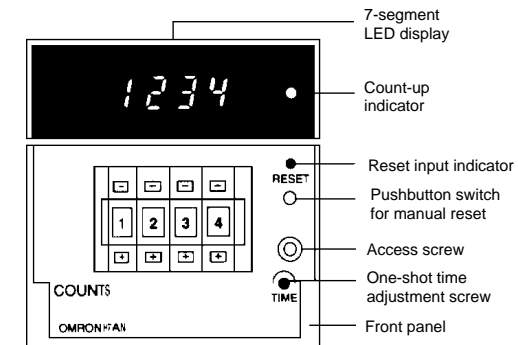

H7AN-W4D, H7AN-W4DM, H7AN-WE4D, H7AN-WE4DM

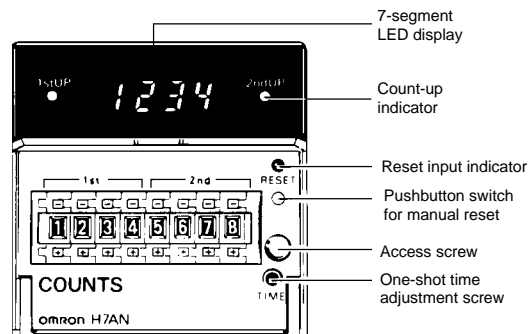

H7AN-R6D, H7AN-R6DM

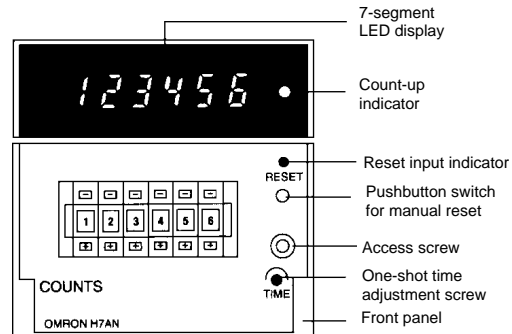

H7AN-RW6D, H7AN-RW6DM

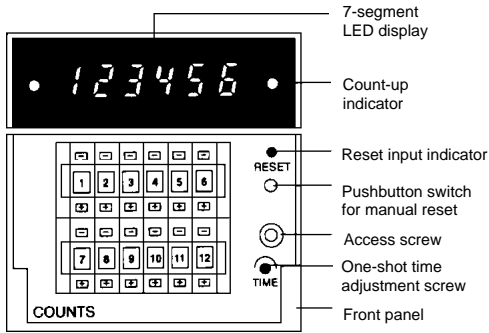

H7AN-R8D, H7AN-R8DM

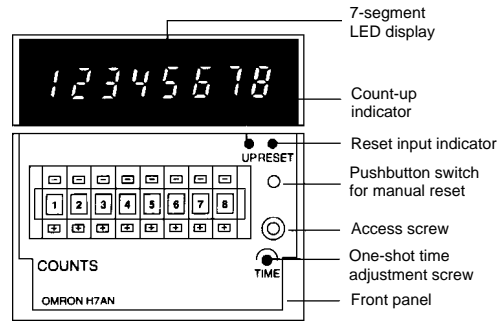

H7AN-T4, H7AN-T4M,  
H7AN-ET4, H7AN-ET4M

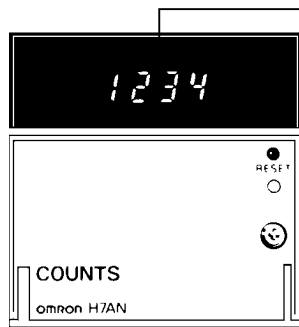

H7AN-RT6, H7AN-RT6M

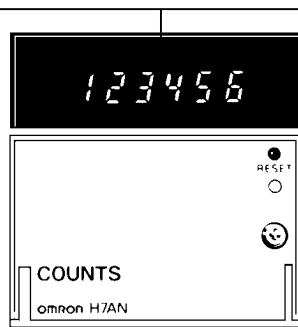

H7AN-RT8, H7AN-RT8M

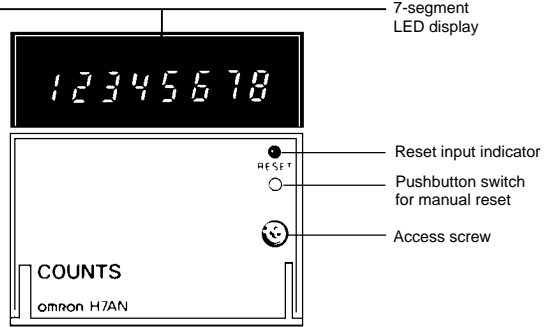

■ ACCESS TO DIP SWITCHES

The internal specification selector switches are used to program counting function, maximum counting speed, UP or DOWN display, manual reset function enable or disable, output level of the solid-state output when the count is up, and one-shot output/sustained output of the control output(s).

Open the front cover to expose the access screw on the lower right side.

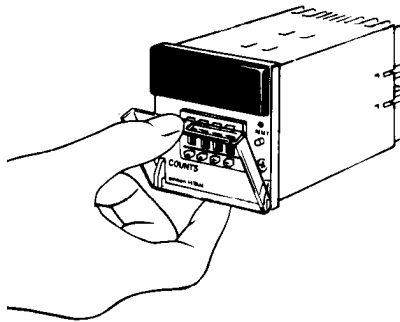

The internal unit can be drawn out by loosening the access screw. This allows the counter to have specifications changed without rewiring.

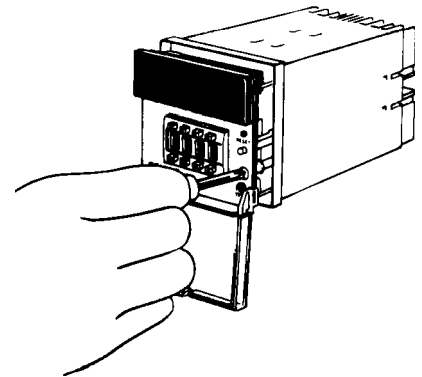

**FUNCTION SELECTIONS MADE BY INTERNAL DIP SWITCHES**

To program the function specifications, set the rotary DIP switches and slide switches mounted on the PC board located at the right side of the internal unit (when viewed from the front).

In the case of the "-M" type counters, with backup power supply function for memory protection, the new count value set by the thumbwheel switch or changes to the counting functions and operation modes

by the DIP switches become effective only when the counter is reset by external or manual reset, but not by automatic reset.

**H7AN-2D, H7AN-2DM**

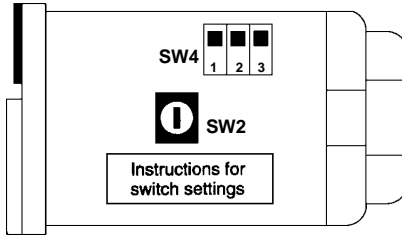

**SW2 Output mode selector switch**

| Switch position | Operation mode |
|-----------------|----------------|
| 0               | N              |
| 1               | F              |
| 2               | C              |
| 3               | R              |
| 4               | K              |
| 5               | P              |
| 6               | Q              |
| 7               | N              |
| 8               | N              |
| 9               | F              |
| A               | C              |
| B               | R              |
| C               | K              |
| D               | P              |
| E               | Q              |
| F               | N              |

**SW4-1 Solid-state output level selector switch**

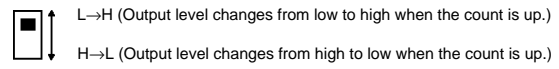

**SW4-2 Manual reset selector switch**

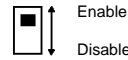

**SW4-3 UP/DOWN selector switch**

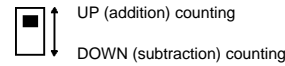

**H7AN-E2D, H7AN-E2DM**

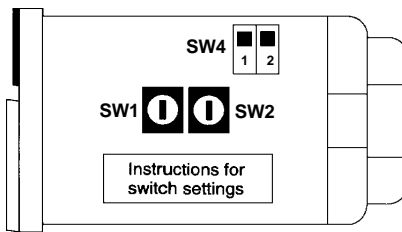

**SW2 Output mode selector switch**

| Switch position | Operation mode |
|-----------------|----------------|
| 0               | N              |
| 1               | F              |
| 2               | C              |
| 3               | R              |
| 4               | K              |
| 5               | P              |
| 6               | Q              |
| 7               | N              |
| 8               | N              |
| 9               | F              |
| A               | C              |
| B               | R              |
| C               | K              |
| D               | P              |
| E               | Q              |
| F               | N              |

**SW4-1 Solid-state output level selector switch**

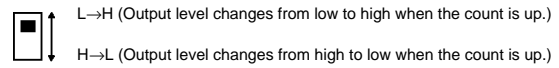

**SW4-2 Manual reset selector switch**

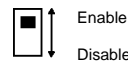

**SW1 Count input function selector**

| Switch position | Input mode                |
|-----------------|---------------------------|
| 0               | A (command inputs L→H)    |
| 1               | A (command inputs L→H)    |
| 2               | B (individual inputs L→H) |
| 3               | C (quadrature inputs L→H) |
| 4               | D (command inputs H→L)    |
| 5               | D (command inputs H→L)    |
| 6               | E (individual inputs H→L) |
| 7               | F (quadrature inputs H→L) |
| 8               | A (command inputs L→H)    |
| 9               | A (command inputs L→H)    |

H7AN-4D, H7AN-4DM

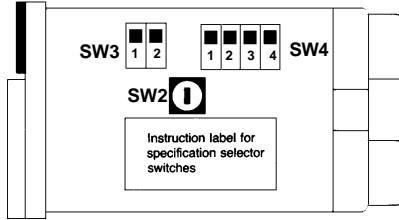

**SW3-1 Count input 1 maximum counting speed selector switch**

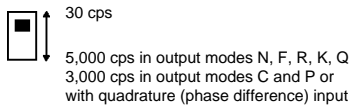

**SW3-2 Count input 2 maximum counting speed selector switch**

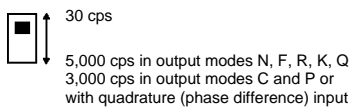

**SW4-1 Solid-state output level selector switch**

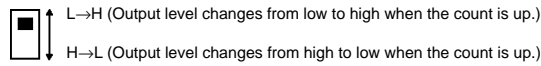

**SW4-2 Manual reset selector switch**

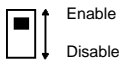

**SW4-3 UP/DOWN selector switch**

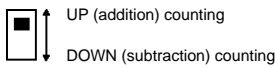

**SW2 Output mode selector switch**

| Switch position | Operation mode |
|-----------------|----------------|
| 0               | N              |
| 1               | F              |
| 2               | C              |
| 3               | R              |
| 4               | K              |
| 5               | P              |
| 6               | Q              |
| 7               | N              |
| 8               | N              |
| 9               | F              |
| A               | C              |
| B               | R              |
| C               | K              |
| D               | P              |
| E               | Q              |
| F               | N              |

H7AN-E4D, H7AN-E4DM

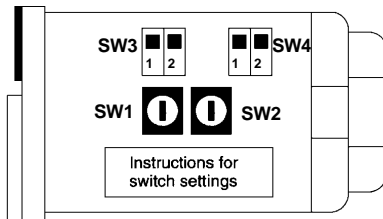

**SW1 Count input function selector**

| Switch position | Input mode                |
|-----------------|---------------------------|
| 0               | A (command inputs L→H)    |
| 1               | A (command inputs L→H)    |
| 2               | B (individual inputs L→H) |
| 3               | C (quadrature inputs L→H) |
| 4               | D (command inputs H→L)    |
| 5               | D (command inputs H→L)    |
| 6               | E (individual inputs H→L) |
| 7               | F (quadrature inputs H→L) |
| 8               | A (command inputs L→H)    |
| 9               | A (command inputs L→H)    |

**SW3-1 Count input 1 maximum counting speed selector switch**

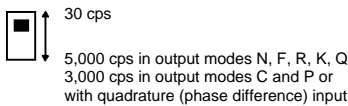

**SW3-2 Count input 2 maximum counting speed selector switch**

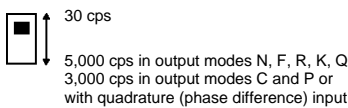

**SW4-1 Solid-state output level selector switch**

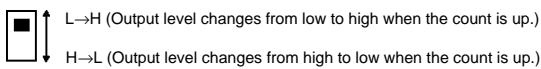

**SW4-2 Manual reset selector switch**

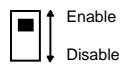

**SW2 Output mode selector switch**

| Switch position | Operation mode |
|-----------------|----------------|
| 0               | N              |
| 1               | F              |
| 2               | C              |
| 3               | R              |
| 4               | K              |
| 5               | P              |
| 6               | Q              |
| 7               | N              |
| 8               | N              |
| 9               | F              |
| A               | C              |
| B               | R              |
| C               | K              |
| D               | P              |
| E               | Q              |
| F               | N              |

H7AN-W4D, H7AN-W4DM

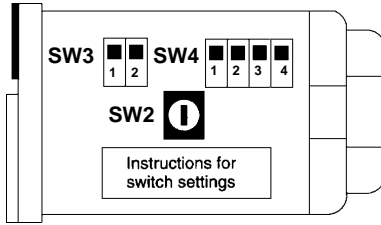

**SW3-1 Count input 1 maximum counting speed selector switch**

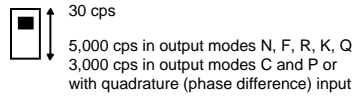

**SW3-2 Count input 2 maximum counting speed selector switch**

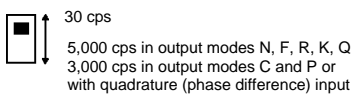

**SW4-1 Solid-state output 1 level selector switch**

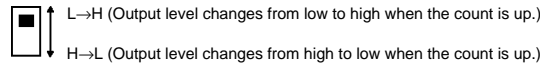

**SW4-2 Solid-state output 2 level selector switch**

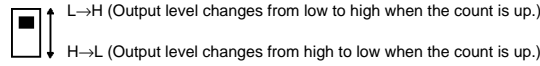

**SW4-3 Manual reset selector switch**



**SW4-4 UP/DOWN selector switch**

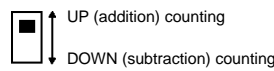

**SW2 Output mode selector switch**

| Switch position | Operation mode |
|-----------------|----------------|
| 0               | N              |
| 1               | F              |
| 2               | C              |
| 3               | R              |
| 4               | K              |
| 5               | P              |
| 6               | Q              |
| 7               | N              |
| 8               | N              |
| 9               | F              |
| A               | C              |
| B               | R              |
| C               | K              |
| D               | P              |
| E               | Q              |
| F               | N              |

Note: In positions 0-7, Output 1 is a sustained output. In positions 8-F, Output 1 is a fixed 0.5 sec one-shot.

H7AN-WE4D, H7AN-WE4DM

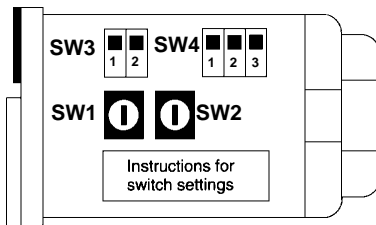

**SW1 Count input function selector**

| Switch position | Input mode                |
|-----------------|---------------------------|
| 0               | A (command inputs L→H)    |
| 1               | A (command inputs L→H)    |
| 2               | B (individual inputs L→H) |
| 3               | C (quadrature inputs L→H) |
| 4               | D (command inputs H→L)    |
| 5               | D (command inputs H→L)    |
| 6               | E (individual inputs H→L) |
| 7               | F (quadrature inputs H→L) |
| 8               | A (command inputs L→H)    |
| 9               | A (command inputs L→H)    |

**SW3-1 Count input 1 maximum counting speed selector switch**

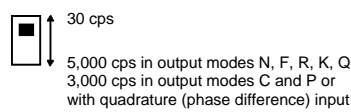

**SW3-2 Count input 2 maximum counting speed selector switch**

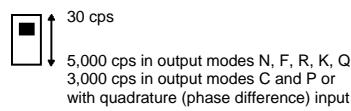

**SW4-1 Solid-state output 1 level selector switch**

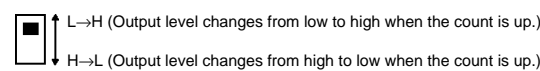

**SW4-2 Solid-state output 2 level selector switch**

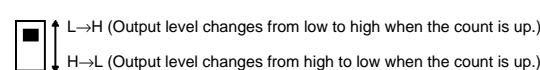

**SW4-3 Manual reset selector switch**



**SW2 Output mode selector switch**

| Switch position | Operation mode |
|-----------------|----------------|
| 0               | N              |
| 1               | F              |
| 2               | C              |
| 3               | R              |
| 4               | K              |
| 5               | P              |
| 6               | Q              |
| 7               | N              |
| 8               | N              |
| 9               | F              |
| A               | C              |
| B               | R              |
| C               | K              |
| D               | P              |
| E               | Q              |
| F               | N              |

Note: In positions 0-7, Output 1 is a sustained output. In positions 8-F, Output 1 is a fixed 0.5 sec one-shot.

H7AN-R6D, H7AN-R6DM

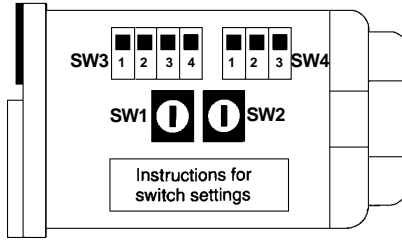

SW1 Count input function selector

| Switch position | Input mode                |
|-----------------|---------------------------|
| 0               | A (command inputs L→H)    |
| 1               | A (command inputs L→H)    |
| 2               | B (individual inputs L→H) |
| 3               | C (quadrature inputs L→H) |
| 4               | D (command inputs H→L)    |
| 5               | D (command inputs H→L)    |
| 6               | E (individual inputs H→L) |
| 7               | F (quadrature inputs H→L) |
| 8               | A (command inputs L→H)    |
| 9               | A (command inputs L→H)    |

SW3-1/SW3-2 Count input 1 maximum counting speed selector switch

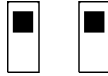

Count Speed

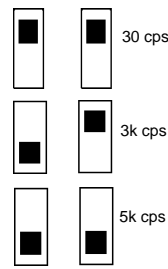

SW3-3/SW3-4 Count input 2 maximum counting speed selector switch

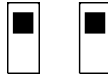

SW4-1 Solid-state output level selector switch



L→H (Output level changes from low to high when the count is up.)  
H→L (Output level changes from high to low when the count is up.)

SW4-2 Set value read selector



Continuous read  
Read when reset

SW4-3 Manual reset selector switch



Enable  
Disable

SW2 Output mode selector switch

| Switch position | Operation mode |
|-----------------|----------------|
| 0               | N              |
| 1               | F              |
| 2               | C              |
| 3               | R              |
| 4               | K              |
| 5               | P              |
| 6               | Q              |
| 7               | N              |
| 8               | N              |
| 9               | F              |
| A               | C              |
| B               | R              |
| C               | K              |
| D               | P              |
| E               | Q              |
| F               | N              |

H7AN-RW6D, H7AN-RW6DM

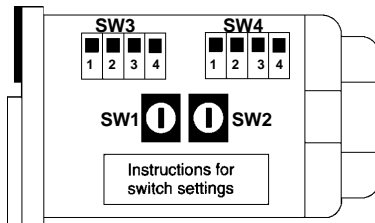

SW1 Count input function selector

| Switch position | Input mode                |
|-----------------|---------------------------|
| 0               | A (command inputs L→H)    |
| 1               | A (command inputs L→H)    |
| 2               | B (individual inputs L→H) |
| 3               | C (quadrature inputs L→H) |
| 4               | D (command inputs H→L)    |
| 5               | D (command inputs H→L)    |
| 6               | E (individual inputs H→L) |
| 7               | F (quadrature inputs H→L) |
| 8               | A (command inputs L→H)    |
| 9               | A (command inputs L→H)    |

SW3-1/SW3-2 Count input 1 maximum counting speed selector switch

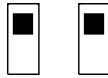

Count Speed

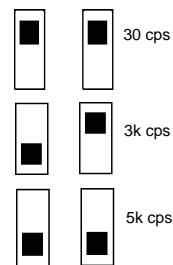

SW3-3/SW3-4 Count input 2 maximum counting speed selector switch

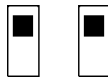

SW4-1 Solid-state output 1 level selector switch



L→H (Output level changes from low to high when the count is up.)  
H→L (Output level changes from high to low when the count is up.)

SW4-2 Solid-state output 2 level selector switch



L→H (Output level changes from low to high when the count is up.)  
H→L (Output level changes from high to low when the count is up.)

SW4-3 Set value read selector



Continuous read  
Read when reset

SW4-4 Manual reset selector switch



Enable  
Disable

SW2 Output mode selector switch

| Switch position | Operation mode |
|-----------------|----------------|
| 0               | N              |
| 1               | F              |
| 2               | C              |
| 3               | R              |
| 4               | K              |
| 5               | P              |
| 6               | Q              |
| 7               | N              |
| 8               | N              |
| 9               | F              |
| A               | C              |
| B               | R              |
| C               | K              |
| D               | P              |
| E               | Q              |
| F               | N              |

Note: In positions 0-7, Output 1 is a sustained output. In positions 8-F, Output 1 is a fixed 0.5 sec one-shot.

H7AN-R8D, H7AN-R8DM

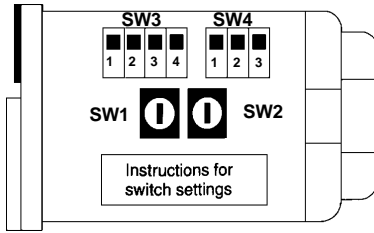

**SW1 Count input function selector**

| Switch position | Input mode                |
|-----------------|---------------------------|
| 0               | A (command inputs L→H)    |
| 1               | A (command inputs L→H)    |
| 2               | B (individual inputs L→H) |
| 3               | C (quadrature inputs L→H) |
| 4               | D (command inputs H→L)    |
| 5               | D (command inputs H→L)    |
| 6               | E (individual inputs H→L) |
| 7               | F (quadrature inputs H→L) |
| 8               | A (command inputs L→H)    |
| 9               | A (command inputs L→H)    |

**SW3-1/SW3-2 Count input 1 maximum counting speed selector switch**

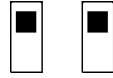

**SW3-3/SW3-4 Count input 2 maximum counting speed selector switch**

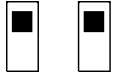

**Count Speed**

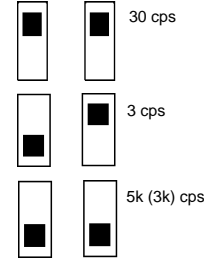

**SW2 Output mode selector switch**

| Switch position | Operation mode |
|-----------------|----------------|
| 0               | N              |
| 1               | F              |
| 2               | C              |
| 3               | R              |
| 4               | K              |
| 5               | P              |
| 6               | Q              |
| 7               | N              |
| 8               | N              |
| 9               | F              |
| A               | C              |
| B               | R              |
| C               | K              |
| D               | P              |
| E               | Q              |
| F               | N              |

**SW4-1 Solid-state output level selector switch**

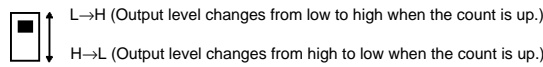

**SW4-2 Set value read selector**

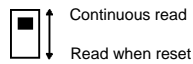

**SW4-3 Manual reset selector switch**

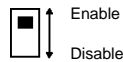

H7AN-T4, H7AN-T4M

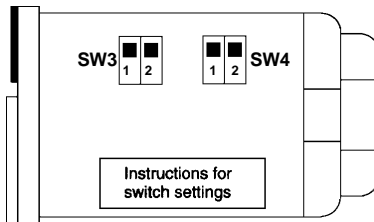

**SW3-1 Count input 1 maximum counting speed selector switch**

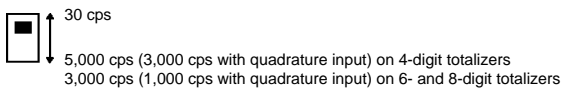

**SW3-2 Count input 2 maximum counting speed selector switch**

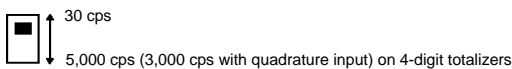

**SW4-1 Manual reset selector switch**

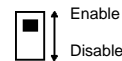

**SW4-2 UP/DOWN selector switch**

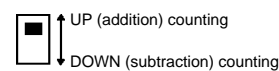



H7AN-ET4, H7AN-ET4M

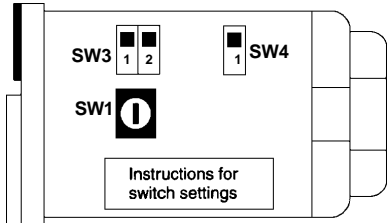

**SW1 Count input function selector**

| Switch position | Input mode                |
|-----------------|---------------------------|
| 0               | A (command inputs L→H)    |
| 1               | A (command inputs L→H)    |
| 2               | B (individual inputs L→H) |
| 3               | C (quadrature inputs L→H) |
| 4               | D (command inputs H→L)    |
| 5               | D (command inputs H→L)    |
| 6               | E (individual inputs H→L) |
| 7               | F (quadrature inputs H→L) |
| 8               | A (command inputs L→H)    |
| 9               | A (command inputs L→H)    |

**SW3-1 Count input 1 maximum counting speed selector switch**

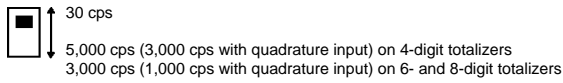

**SW3-2 Count input 2 maximum counting speed selector switch**

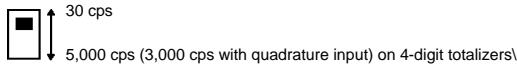

**SW4 Manual reset selector switch**

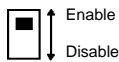

H7AN-RT6, H7AN-RT6M, H7AN-RT8, H7AN-RT8M

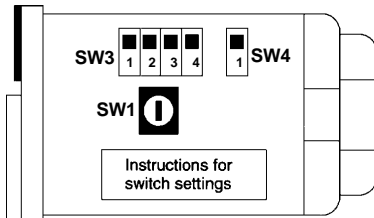

**SW1 Count input function selector**

| Switch position | Input mode                |
|-----------------|---------------------------|
| 0               | A (command inputs L→H)    |
| 1               | A (command inputs L→H)    |
| 2               | B (individual inputs L→H) |
| 3               | C (quadrature inputs L→H) |
| 4               | D (command inputs H→L)    |
| 5               | D (command inputs H→L)    |
| 6               | E (individual inputs H→L) |
| 7               | F (quadrature inputs H→L) |
| 8               | A (command inputs L→H)    |
| 9               | A (command inputs L→H)    |

**SW3-1/SW3-2 Count input 1 maximum counting speed selector switch**

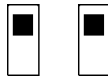

**SW3-3/SW3-4 Count input 2 maximum counting speed selector switch**

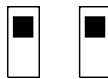

**SW4 Manual reset selector switch**

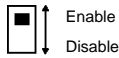

**Count Speed**

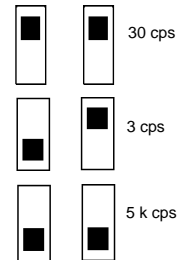

# Installation

## ■ MOUNTING

The illustrations at right show how to mount the H7AN counter in a panel with the Y92H-5 mounting brackets supplied with each unit. Insert the counter through the panel. Loosen the screw on the bracket, then insert the bracket in the slot on the bottom of the counter. Tighten the screw until it makes a clicking sound. Repeat the process with the top bracket.

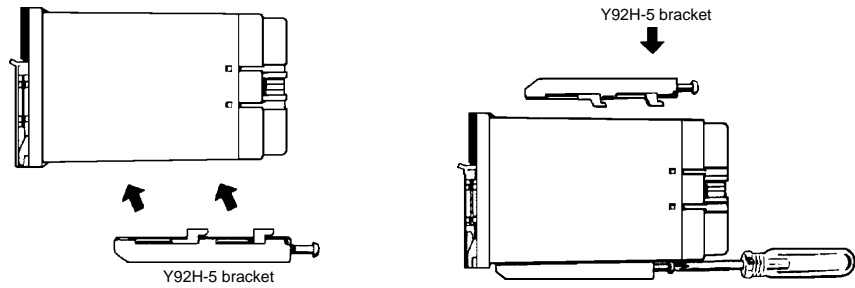

## ■ CAUTIONS REGARDING POWER SUPPLY, INPUT AND OUTPUT SIGNALS

Allow 50 ms after power application for the voltage rise time in the internal circuit. The counter may not operate in response to signals input during this period.

Counters with memory protection (-M types) may respond to input signals during 50 ms after the power is turned off (or after power failure) since this period is the voltage fall time in the internal circuit.

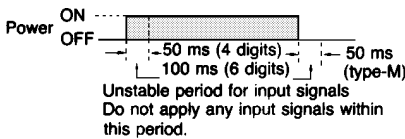

In the case of a momentary power failure, counters without backup power supply operate as follows depending upon the length of the power outage:

| Power failure duration | Action when power is restored                 |
|------------------------|---|
| 0.5 sec or more        | Counter is reset                              |
| 0.01 sec or less       | Status before power failure is retained       |
| 0.01 to 0.5 sec        | Operation is unstable, either one is possible |

## ■ RESET AND THE DISPLAY

While the reset signal (external or manual) is being applied, the digital display is extinguished in all digit positions and the reset LED indicator lights to show the reset input signal is being applied. When a reset is completed, the reset value is displayed on the digital display. Totalizing counters do not have a reset indicator.

In output operation modes C, K, P, and Q, operations that cause the set time to be up twice within the one-shot time are not recommended.

In output mode C, the internal counting circuit is reset at the same time as when the set count is up. For this reason, the up count value is not displayed.

Counters with memory back-up (-M type) do not have a power reset function, so care must be taken in the following situations:

When power is applied to the counter for the first time, the counter must be reset by applying external or manual input.

If the internal specifications are changed during a power failure, the counter must be reset externally or manually after the power is restored. Failure to apply the reset will cause the counter to operate with the previous settings. If the set value is changed during a power failure, the counter need not be reset after power recovery.

The back-up battery lasts about 10 years in normal use, but cannot be replaced.

## ■ SETTINGS

Do not reset thumbwheel switches while the counter is operating.

Do not set both presets of a double preset counter to the same value.

Do not allow the thumbwheel setting fall between numbers as the counter will ignore that digit and give a possible wrong count value.

When the count value is all zeroes, there will be a momentary control output upon power application. This can be used to check normal output.

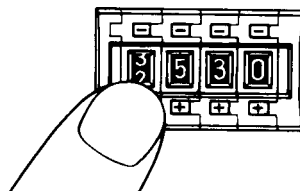

530  
is how the counter will interpret this setting

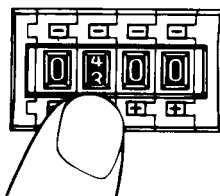

0000  
causes a momentary output

**■ TESTING**

When conducting dielectric test, impulse voltage test, insulation resistance test, etc., between the electric circuit and the non-current-carrying metal parts with the counter mounted on the control board, remove the internal unit to isolate it from the counter circuit.

Removal of the internal unit is necessary to prevent it from being damaged by the test voltage flowing across the power supply terminals of the counter, if some of the components mounted on the control board have insufficient dielectric strength or insulation resistance.

**NOTE: DIMENSIONS ARE SHOWN IN MILLIMETERS. To convert millimeters to inches divide by 25.4.**

**OMRON****OMRON ELECTRONICS LLC**

One East Commerce Drive  
Schaumburg, IL 60173

**1-800-55-OMRON**

Cat. No. GC TMCN1

3/02

**OMRON ON-LINE**

Global - <http://www.omron.com>  
USA - <http://www.omron.com/oei>  
Canada - <http://www.omron.com/oci>

Specifications subject to change without notice.

**OMRON CANADA, INC.**

885 Milner Avenue  
Scarborough, Ontario M1B 5V8

**416-286-6465**

Printed in the U.S.A.