

070 Series ANSI Switchboard Meters



This high quality range of Switchboard instruments complies with the American specification ANSI-C39.1 (1981) accuracy class 1. Available in 4 1/2" and 8 3/4" case sizes, their rugged design characteristics suit the most demanding of environmental applications. This extensive range of analogue and digital/analogue meters utilise a high shock oil dampened movement, and provide 1% accuracy for all RMS AC and DC ranges. The range offers various customised options and features.

Description

070 series offers two case sizes, 4 1/2" (Models 075, 077 & 078) and 8 3/4" (Model 079). Model 078 is high shock hermetically sealed and all models have heavy gauge pressed steel cases. Mounting is by four integral studs.

Models 075 & 077 are a one piece flame retardant polycarbonate moulding with a matt black finished bezel area, and a specially contoured window to minimise reflection from adjacent light sources. Model 079 has a black pressed steel bezel with a toughened glass window, and Model 078 has a die-cast bezel and a projecting moulded toughened glass window, which incorporates a gas tight zero adjuster.

Scales are 240° moving iron and 250° moving coil with parallax error-free platform dials. Standard dials are matt white with black printed scales and bar knife-edge pointers. Black dials with white or yellow scales and pointers are also available.

General options include supplementary red pointer (075 & 077), slave pointer, calibration for non standard ambient temperatures, special scales, trim potentiometers, and illuminated dials with white or red light sources.

Features

- Rugged Hi-Q taut-band suspension
- Accuracy class 1
- JIS dimensioned product available on request

Benefits

- Meets all the requirements of ANSI-C39.1 (1981)
- Parallax error-free platform dials
- Bump, Shock and vibration proof
- Customised options and features

Applications

- Switchgear
- Distribution systems
- Generator sets
- Control panels
- Energy management
- Building management
- Utility power monitoring
- Process control
- Motor control

Approvals

- UL approvals file No: E87815
- CSA approvals file No: LR99712-1
- ABS American Bureau of Shipping approvals 93-LD 17806-X
- ISSeP Institute Scientifique de Service Public approvals 97D.101.226x

Specification

Performance:	ANSI C39.1 (1981)
Accuracy:	Class 1
Terminals:	10-32 UNF terminals (M5 screw clamp terminal for Model 075)
Dielectric Voltage:	Withstand test 2.3kV for 1 minute
Response Time:	Approximately 2.5 seconds to full scale (077 and 078) and 3.5 seconds (079)
Overshoot:	33% maximum
Standard Calibration:	23°C
Operating Temperature:	0°C to +40°C. Model 078: -40°C to +70°C.
Storage Temperature:	-10°C to +50°C
Extreme Temp Range:	-20°C -to +65°C
Enclosure Integrity:	Models 075/077/079 to IP54(NEMA 3S) splash proof IP55 (NEMA 4) hoseproof is an optional extra Model 078 to IP67 (NEMA 6 & 6P)
Fixing on Panel:	4 integral 1/4"-28 UNF fixing studs
Approvals:	EMC and LVD, UL, CSA, ABS and ISSep Approvals

Dimensions

Model	Panel Cut-out			Rear View				
	Dia	A	B	C	D	E	F	G
075	103	86	43	110	17	-	30	101
077	103	86	43	110	17	-	30	101
078	103	86	43	110	17	-	30	101
079	229	86	43	229	17	-	30	101

Dimension E varies with measured parameter - see product code table overleaf.

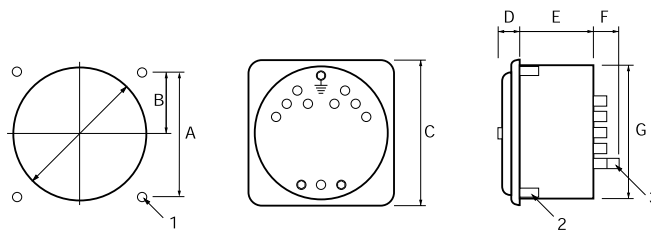

1 - 4 Fixing holes Ø 8mm. 2 - 1/4-28 UNF fixing studs. 3 - 10-32 UNF Terminals (M5 screw clamp terminal on model 075).

070 Series ANSI Switchboard Meters



Product Codes

Type of Instrument	Ranges	Case Code				Product Code
		075	077	078	079	
A.C. Ammeter Moving iron	0.5-10A	56	56	-	-	075/077-08A
A.C. Ammeter Moving iron	0.5-10A	-	-	86	86	078/079-08A
A.C. Ammeter Moving iron	10.1-30A	-	86	86	86	077/078/079-08A
Slave Pointer Ammeter	1 or 5A		86			077-08D
6 x overload A.C. Ammeter	5/30A - 30/180A	-	86	86	86	077/078/079-086
A.C. Voltmeter Moving iron	30-800V	-	86	86	86	077/078/079-08V
A.C. Rectified Ammeter	1-30A	56	56	86	56	075/077/078/079-05B
A.C. Rectified Voltmeter	30-800V	56	56	86	56	075/077/078/079-05W
A.C. Voltmeter expanded scale	110-130V	-	86	86	86	077/078/079-05Y
A.C. RMS Ammeter	1-30A	56	56	86	56	075/077/078/079-05F
A.C. RMS Voltmeter	150-750V	56	56	86	56	075/077/078/079-05G
Slave Pointer Voltmeter	50-300V		86			077-05X
Elapsed time meter (99999.99)	50 or 60Hz / 100-440V* and D.C.	-	56	56	-	077/078-155/156/077-151
Frequency meter	50 or 60 or 400Hz/100-440V**	86	86	86	86	075/077/078/079-41L
A.C. Wattmeter or Varmeter	0.2-10A/100-440V*	-	132	132	132	077/078/079-21 or 31
360° Rotary Power factor meter	0.2-10A/100-600V	-	132	132	132	077/078/079-13
360° Rotary synchroscope	100/125V, 200/250, 380/450***	-	132	132	132	077/078/079-14
LED Synchroscope only	63.5-480V****	-	86	-	-	077-14A
LED Synchroscope & Synchro Check Relay	63.5-480V****	-	86	-	-	077-14
A.C. Meter relay	A.C. 6V-500V, 100µA-1A, 5A via C.T.	-	86	-	-	077-30 (see Meter Relay section)
Phase sequence indicator	100-150, 151-300, 301-500V	-	56	-	-	077-12P
Maximum demand Indicator	1 or 5A	-	86	-	-	077-16
Tap position indicator	1-18 steps. 400Ω	-	86	-	-	077-45P
Transducer operated indicator	1, 5, 10, 20, or 4/20mA	56	56	56	56	075/077/078/079-05
D.C. Ammeter Moving Coil	200µA - 30A	56	56	56	56	075/077/078/079-05A
D.C. Voltmeter Moving Coil	50mV-600V	56	56	56	56	075/077/078/079-05V
D.C. Meter relay	100mV-500V, 10µA-15A	-	86	-	-	077-30 (see Meter Relay section)
Temperature Indicator	RTD	-	86	86	86	077/078/079-45R
Temperature Indicator	Thermocouple	-	86	86	86	077/078/079-45T
240° Phase Angle /Power Factor	1 or 5A, 100-400V 50, 60 or 400Hz	-	132	132	132	077/078/079-42
Watt/hour Indicators:						
Watt/hour indicator	1 or 5A / 69-277V****	-	132	-	-	077-KH
Transducer operated	1, 5, 10, 20, or 4/20mA	-	132	132	-	077-KH
Analogue/LED Digital indicators						
A.C. Ammeter	1mA - 10A	-	86	-	-	077-DIB
A.C. Voltmeter	200mV - 600V	-	86	-	-	077-DIW
A.C. Wattmeter	69V/5A, 120V/5A, 50 or 60Hz	-	86	-	-	077-DW
A.C. Varmeter	120V/5A, 208V/5A, 50 or 60Hz	-	86	-	-	077-DX
Phase Angle meter	69V/5A, 120V/5A, 50 or 60Hz	-	86	-	-	077-DP
Frequency meter	110/130V, 50 or 60Hz	-	86	-	-	077-DZ
D.C. Ammeter	1mA - 1A	-	86	-	-	077-DIA
D.C. Voltmeter	20mV - 600V	-	86	-	-	077-DIV
Transducer Indicator	D.C. Milliamps	-	86	-	-	077-DIT
Tachometer	A.C. or D.C. rated	-	86	-	-	077-DI2

* 100-440V = (100/125, 200/250, 380/440)

** 100-440V = (100/125,200/250, 380/440). Frequencies 45/55,55/65,45/65, 47/53, 57/63, 360/440.

*** Using transformer box 855-954

**** Nominal voltage to be specified

For specification and connection diagrams, please refer to equivalent models in 240 Series DIN Panel Meter section.

Replace 244 with 077 etc., e.g. 244-210 becomes 077-210.



A.C. & D.C. Ammeters, Voltmeters and Frequency Meters

This range of self contained Hi-Q taut band moving coil meters feature with 250° linear scale and oil dampened mechanisms for superior performance in high vibration situations. AC instruments are available with true RMS converting circuit or RMS compensated rectifier. Some types of frequency meters can be damaged by transient supply voltage spikes. Crompton 077-41 frequency meters can withstand, without damage, 10 successive applications of transient spikes of 1250 volts. The range offers UL and CSA approvals. JIS dimensioned products are available on request.

Specification – General

Manufactured in accordance with American National Standards ANSI C39.1, 1981

Accuracy:	±1% full scale at 23°C (73°F)
Scale Arc:	250° full scale deflection
Scale Length:	077 & 078: 175.2 mm (6.9") 079: 353 mm (13.9")
Scale Plate:	2 piece, platform type
Response Time:	077 & 078: Approximately 2.5 seconds to full scale 079: Approximately 3.5 seconds to full scale
Operating Temperature:	0 to 40°C (32 to 104°F)
Storage Temperature:	-10 to +50°C (14 to 122°F)
Extreme Temp Range:	-20° to +65°C (-4° to +149°F)
Terminals:	Standard 10-32 UNF stud Optional M5 screw clamp
Position of Use:	Vertical (scale)
Dielectric Withstand:	2300V A.C. for 1 minute between electrical circuit and case
Overshoot:	33% maximum
Enclosure Code:	077 & 079: IP54, optional IP55 078: IP67
Approvals:	EMC and LVD. UL recognised File No: E87815. CSA recognised File No: LR99712-1

Specification – Ammeters and Voltmeters

Overload Rating:	A.C. Ammeters - 2 x continuous, 50 x for 1 second A.C. Voltmeters and frequency meters - 1.2 x continuous D.C. Ammeters - 2 x continuous 10 x for 1 second D.C. Voltmeters - 1.2 x continuous
Frequency Range:	A.C. calibration 60Hz ±20%

Specification – Frequency Meters

Response Time:	3 seconds maximum
External Temperature Influence:	0.6 times accuracy maximum with ±10°C from reference temperature
External Field Influence:	2.0 times accuracy maximum with 0.5mT field
Acceptable input Harmonic Content:	Up to 30% distortion

Maximum Frequency Hz	Center Scale Hz	Error In Hz
45-55	50	0.15
46-54	50	0.15
45-65	55	0.25
50-70	60	0.25
55-65	60	0.15
56-64	60	0.15
58-62	60	0.08
350-450	400	1.30
360-440	400	1.25
380-420	400	0.80

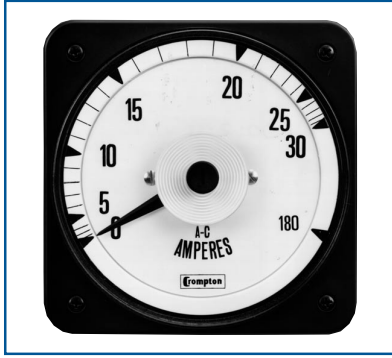

A.C. Overload Ammeters

Moving Iron A.C. Ammeters

Product Codes – Self Contained 40/70Hz (Accuracy $\pm 1\%$, 60Hz)***

Rating	Scaling*	4 1/2" Square Flange		8 1/2" Square Flange
		Standard Case Catalogue No.	Sealed Case Hi-Shock Catalogue No.	Standard Case Catalogue No.
1A	0-1A	•/+077-08AA-LALA-C6	078-08AJ-LALA-C6	•079-08AA-LALA-C6
1.5A	0-1.5A	•/+077-08AA-LCLC-C6	078-08AJ-LCLC-C6	•079-08AA-LCLC-C6
2A	0-2A	•/+077-08AA-LELE-C6	078-08AJ-LELE-C6	•079-08AA-LELE-C6
3A	0-3A	•/+077-08AA-LJLJ-C6	078-08AJ-LJLJ-C6	•079-08AA-LJLJ-C6
5A	0-5A	•/+077-08AA-LSLS-C6	078-08AJ-LSLS-C6	•079-08AA-LSLS-C6
7.5A	0-7.5A	•/+077-08AA-MFMF-C6	078-08AJ-MFMF-C6	•079-08AA-MFMF-C6
10A	0-10A	•/+077-08AA-MTMT-C6	078-08AJ-MTMT-C6	•079-08AA-MTMT-C6
15A	0-15A	•/+077-08AA-NDND-C6	078-08AJ-NDND-C6	•079-08AA-NDND-C6
20A	0-20A	•/+077-08AA-NGNG-C6	078-08AJ-NGNG-C6	•079-08AA-NGNG-C6
30A	0-30A	•/+077-08AA-NLNL-C6	078-08AJ-NLNL-C6	•079-08AA-NLNL-C6

Product Codes – Transformer Rated 40/70Hz - Burden 0.3VA***

5 A	0-10A	•/+077-08AA-LSMT-C6	078-08AJ-LSMT-C6	•079-08AA-LSMT-C6
5 A	0-15A	•/+077-08AA-LSND-C6	078-08AJ-LSND-C6	•079-08AA-LSND-C6
5 A	0-20A	•/+077-08AA-LSNG-C6	078-08AJ-LSNG-C6	•079-08AA-LSNG-C6
5 A	0-25A	•/+077-08AA-LSNJ-C6	078-08AJ-LSNJ-C6	•079-08AA-LSNJ-C6
5 A	0-30A	•/+077-08AA-LSNL-C6	078-08AJ-LSNL-C6	•079-08AA-LSNL-C6
5 A	0-40A	•/+077-08AA-LSNP-C6	078-08AJ-LSNP-C6	•079-08AA-LSNP-C6
5 A	0-50A	•/+077-08AA-LSNT-C6	078-08AJ-LSNT-C6	•079-08AA-LSNT-C6
5 A	0-75A	•/+077-08AA-LSPB-C6	078-08AJ-LSPB-C6	•079-08AA-LSPB-C6
5 A	0-100A	•/+077-08AA-LSPK-C6	078-08AJ-LSPK-C6	•079-08AA-LSPK-C6
5 A	0-150A	•/+077-08AA-LSPZ-C6	078-08AJ-LSPZ-C6	•079-08AA-LSPZ-C6
5 A	0-200A	•/+077-08AA-LSRL-C6	078-08AJ-LSRL-C6	•079-08AA-LSRL-C6
5 A	0-250A	•/+077-08AA-LSRS-C6	078-08AJ-LSRS-C6	•079-08AA-LSRS-C6
5 A	0-300A	•/+077-08AA-LSRX-C6	078-08AJ-LSRX-C6	•079-08AA-LSRX-C6
5 A	0-400A	•/+077-08AA-LSSC-C6	078-08AJ-LSSC-C6	•079-08AA-LSSC-C6
5 A	0-500A	•/+077-08AA-LSSF-C6	078-08AJ-LSSF-C6	•079-08AA-LSSF-C6
5 A	0-600A	•/+077-08AA-LSSJ-C6	078-08AJ-LSSJ-C6	•079-08AA-LSSJ-C6
5 A	0-800A	•/+077-08AA-LSSN-C6	078-08AJ-LSSN-C6	•079-08AA-LSSN-C6
5 A	0-1000A	•/+077-08AA-LSSS-C6	078-08AJ-LSSS-C6	•079-08AA-LSSS-C6
5 A	0-1200A	•/+077-08AA-LSSU-C6	078-08AJ-LSSU-C6	•079-08AA-LSSU-C6
5 A	0-1500A	•/+077-08AA-LSTC-C6	078-08AJ-LSTC-C6	•079-08AA-LSTC-C6
5 A	0-1600A	•/+077-08AA-LSTE-C6	078-08AJ-LSTE-C6	•079-08AA-LSTE-C6
5 A	0-2000A	•/+077-08AA-LSTM-C6	078-08AJ-LSTM-C6	•079-08AA-LSTM-C6
5 A	0-2500A	•/+077-08AA-LSTU-C6	078-08AJ-LSTU-C6	•079-08AA-LSTU-C6
5 A	0-3000A	•/+077-08AA-LSUA-C6	078-08AJ-LSUA-C6	•079-08AA-LSUA-C6
5 A	0-4000A	•/+077-08AA-LSUE-C6	078-08AJ-LSUE-C6	•079-08AA-LSUE-C6
5 A	0-5000A	•/+077-08AA-LSUJ-C6	078-08AJ-LSUJ-C6	•079-08AA-LSUJ-C6
5 A	0-6000A	•/+077-08AA-LSUP-C6	078-08AJ-LSUP-C6	•079-08AA-LSUP-C6
5 A	0-7000A	•/+077-08AA-LSUS-C6	078-08AJ-LSUS-C6	•079-08AA-LSUS-C6
5 A	0-8000A	•/+077-08AA-LSUW-C6	078-08AJ-LSUW-C6	•079-08AA-LSUW-C6

Product Code – A.C. Overload Ammeters - True RMS Reading*** Self contained 40/70Hz (Accuracy $\pm 1\%$)

5/30A	TO SUIT	077-086A-LS**-C6	078-086J-LS**-C6	079-086A-LS**-C6
-------	---------	------------------	------------------	------------------

077 moving iron ammeters available as listed above

Rated 5A for standard C.T.'s with 6 x full scale.
Overload portion of the scale is not subject to the accuracy guarantee.
• UL recognised File # E87815
+ CSA Approved File # LR52592

* Other scales are available
** Specify scale required
*** Case types 077/078/079 use 10-32 UNF terminals. For M5 screw clamp terminals stipulate case type 075

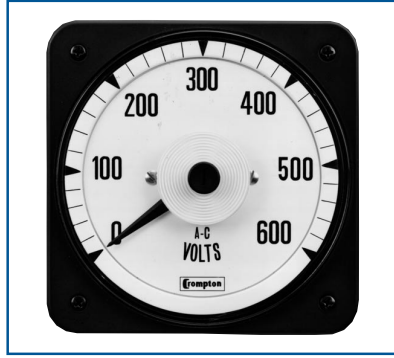

A.C. Voltmeter

Moving Iron A.C. Voltmeters

Product Codes – Self Contained 60Hz $\pm 20\%$ (Accuracy $\pm 1\%$)***

Rating	Scaling*	4½" Square Flange		8¾" Square Flange
		Standard Case Catalogue No.	Sealed Case Hi-Shock Catalogue No.	Standard Case Catalogue No.
150V	0-150V	+/-077-08VA-PZPZ-C6	078-08VJ-PZPZ-C6	+079-08VA-PZPZ-C6
250V	0-250V	+/-077-08VA-RSRS-C6	078-08VJ-RSRS-C6	+079-08VA-RSRS-C6
300V	0-300V	+/-077-08VA-RXRX-C6	078-08VJ-RXRX-C6	+079-08VA-RXRX-C6
500V	0-500V	+/-077-08VA-SFSF-C6	078-08VJ-SFSF-C6	+079-08VA-SFSF-C6
600V	0-600V	+/-077-08VA-SJSJ-C6	078-08VJ-SJSJ-C6	+079-08VA-SJSJ-C6
750V	0-750V	077-08VA-SMSM-C6	078-08VJ-SMSM-C6	079-08VA-SMSM-C6

Product Codes – Transformer Rated 50/60HZ (Accuracy $\pm 1\%$) 0.8VA @150V***

150V	0-300V	+/-077-08VA-PZRX-C6	078-08VJ-PZRX-C6	+079-08VA-PZRX-C6
150V	0-600V	+/-077-08VA-PZSJ-C6	078-08VJ-PZSJ-C6	+079-08VA-PZSJ-C6
150V	0-750V	+/-077-08VA-PZSM-C6	078-08VJ-PZSM-C6	+079-08VA-PZSM-C6
150V	0-3000V	+/-077-08VA-PZUA-C6	078-08VJ-PZUA-C6	+079-08VA-PZUA-C6
150V	0-5250V	+/-077-08VA-PZUL-C6	078-08VJ-PZUL-C6	+079-08VA-PZUL-C6
150V	0-6000V	+/-077-08VA-PZUP-C6	078-08VJ-PZUP-C6	+079-08VA-PZUP-C6
150V	0-9000V	+/-077-08VA-PZUY-C6	078-08VJ-PZUY-C6	+079-08VA-PZUY-C6
150V	0-15KV	+/-077-08VA-PZWC-C6	078-08VJ-PZWC-C6	+079-08VA-PZWC-C6
150V	0-18KV	+/-077-08VA-PZWD-C6	078-08VJ-PZWD-C6	+079-08VA-PZWD-C6
150V	0-45KV	+/-077-08VA-PZWJ-C6	078-08VJ-PZWJ-C6	+079-08VA-PZWJ-C6
250V	0-600V	+/-077-08VA-RSSJ-C6	078-08VJ-RSSJ-C6	+079-08VA-RSSJ-C6

• UL recognised File # E87815
+ CSA Approved File # LR52592

* Other scales are available
*** Case types 077/078/079 use 10-32 UNF terminals. For M5 screw clamp terminals stipulate case type 075



A.C. Ammeter

RMS Reading A.C. Ammeters

Product Codes – Self Contained 40/70Hz (Accuracy $\pm 1\%$, 60Hz)***

Rating	Scaling*	4½" Square Flange		8¾" Square Flange
		Standard Case Catalogue No.	Sealed Case Hi-Shock Catalogue No.	Standard Case Catalogue No.
1A	0-1A	•/+077-05FA-LALA-C6	078-05FJ-LALA-C6	•079-05fA-LALA-C6
1.5A	0-1.5A	•/+077-05FA-LCLC-C6	078-05FJ-LCLC-C6	•079-05fA-LCLC-C6
2A	0-2A	•/+077-05FA-LELE-C6	078-05FJ-LELE-C6	•079-05fA-LELE-C6
3A	0-3A	•/+077-05FA-LJLJ-C6	078-05FJ-LJLJ-C6	•079-05fA-LJLJ-C6
5A	0-5A	•/+077-05FA-LSLS-C6	078-05FJ-LSLS-C6	•079-05fA-LSLS-C6
7.5A	0-7.5A	•/+077-05FA-MFMF-C6	078-05FJ-MFMF-C6	•079-05fA-MFMF-C6
10A	0-10A	•/+077-05FA-MTMT-C6	078-05FJ-MTMT-C6	•079-05fA-MTMT-C6
15A	0-15A	•/+077-05FA-NDND-C6	078-05FJ-NDND-C6	•079-05fA-NDND-C6
20A	0-20A	•/+077-05FA-NGNG-C6	078-05FJ-NGNG-C6	•079-05fA-NGNG-C6
30A	0-30A	•/+077-05FA-NLNL-C6	078-05FJ-NLNL-C6	•079-05fA-NLNL-C6

For A.C. rectified non-RMS compensated meter please replace the -05F in the product code with -05B.

Product Codes – Transformer Rated 40/70Hz - Burden 0.3VA***

5 A	0-10A	•/+077-05FA-LSMT-C6	078-05FJ-LSMT-C6	•079-05FA-LSMT-C6
5 A	0-15A	•/+077-05FA-LSND-C6	078-05FJ-LSND-C6	•079-05FA-LSND-C6
5 A	0-20A	•/+077-05FA-LSNG-C6	078-05FJ-LSNG-C6	•079-05FA-LSNG-C6
5 A	0-25A	•/+077-05FA-LSNJ-C6	078-05FJ-LSNJ-C6	•079-05FA-LSNJ-C6
5 A	0-30A	•/+077-05FA-LSNL-C6	078-05FJ-LSNL-C6	•079-05FA-LSNL-C6
5 A	0-40A	•/+077-05FA-LSNP-C6	078-05FJ-LSNP-C6	•079-05FA-LSNP-C6
5 A	0-50A	•/+077-05FA-LSNT-C6	078-05FJ-LSNT-C6	•079-05FA-LSNT-C6
5 A	0-75A	•/+077-05FA-LSPB-C6	078-05FJ-LSPB-C6	•079-05FA-LSPB-C6
5 A	0-100A	•/+077-05FA-LSPK-C6	078-05FJ-LSPK-C6	•079-05FA-LSPK-C6
5 A	0-150A	•/+077-05FA-LSPZ-C6	078-05FJ-LSPZ-C6	•079-05FA-LSPZ-C6
5 A	0-200A	•/+077-05FA-LSRL-C6	078-05FJ-LSRL-C6	•079-05FA-LSRL-C6
5 A	0-250A	•/+077-05FA-LSRS-C6	078-05FJ-LSRS-C6	•079-05FA-LSRS-C6
5 A	0-300A	•/+077-05FA-LSRX-C6	078-05FJ-LSRX-C6	•079-05FA-LSRX-C6
5 A	0-400A	•/+077-05FA-LSSC-C6	078-05FJ-LSSC-C6	•079-05FA-LSSC-C6
5 A	0-500A	•/+077-05FA-LSSF-C6	078-05FJ-LSSF-C6	•079-05FA-LSSF-C6
5 A	0-600A	•/+077-05FA-LSSJ-C6	078-05FJ-LSSJ-C6	•079-05FA-LSSJ-C6
5 A	0-800A	•/+077-05FA-LSSN-C6	078-05FJ-LSSN-C6	•079-05FA-LSSN-C6
5 A	0-1000A	•/+077-05FA-LSSS-C6	078-05FJ-LSSS-C6	•079-05FA-LSSS-C6
5 A	0-1200A	•/+077-05FA-LSSU-C6	078-05FJ-LSSU-C6	•079-05FA-LSSU-C6
5 A	0-1500A	•/+077-05FA-LSTC-C6	078-05FJ-LSTC-C6	•079-05FA-LSTC-C6
5 A	0-1600A	•/+077-05FA-LSTE-C6	078-05FJ-LSTE-C6	•079-05FA-LSTE-C6
5 A	0-2000A	•/+077-05FA-LSTM-C6	078-05FJ-LSTM-C6	•079-05FA-LSTM-C6
5 A	0-2500A	•/+077-05FA-LSTU-C6	078-05FJ-LSTU-C6	•079-05FA-LSTU-C6
5 A	0-3000A	•/+077-05FA-LSUA-C6	078-05FJ-LSUA-C6	•079-05FA-LSUA-C6
5 A	0-4000A	•/+077-05FA-LSUE-C6	078-05FJ-LSUE-C6	•079-05FA-LSUE-C6
5 A	0-5000A	•/+077-05FA-LSUJ-C6	078-05FJ-LSUJ-C6	•079-05FA-LSUJ-C6
5 A	0-6000A	•/+077-05FA-LSUP-C6	078-05FJ-LSUP-C6	•079-05FA-LSUP-C6
5 A	0-7000A	•/+077-05FA-LSUS-C6	078-05FJ-LSUS-C6	•079-05FA-LSUS-C6
5 A	0-8000A	•/+077-05FA-LSUW-C6	078-05FJ-LSUW-C6	•079-05FA-LSUW-C6

For A.C. rectified non-RMS compensated meter please replace the -05F in the product code with -05B.

Rated 5A for standard C.T.'s with 6 x full scale.
 Overload portion of the scale is not subject to the accuracy guarantee.
 • UL recognised File # E87815
 + CSA Approved File # LR52592

* Other scales are available
 ** Specify scale required
 *** Case types 077/078/079 use 10-32 UNF terminals. For M5 screw clamp terminals stipulate case type 075

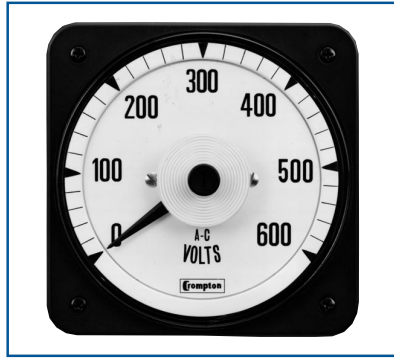

A.C. Voltmeter

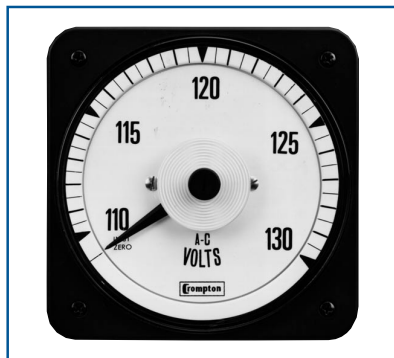

A.C. Voltmeter – Expanded Scale

RMS Reading AC Voltmeters

Product Codes – Self Contained 60Hz ±20% (Accuracy ±1%)***

Rating	Scaling*	4½" Square Flange		8¾" Square Flange
		Standard Case Catalogue No.	Sealed Case Hi-Shock Catalogue No.	Standard Case Catalogue No.
150V	0-150V	+/-077-05GA-PZPZ-C6	078-05GJ-PZPZ-C6	+079-05GA-PZPZ-C6
250V	0-250V	+/-077-05GA-RSRS-C6	078-05GJ-RSRS-C6	+079-05GA-RSRS-C6
300V	0-300V	+/-077-05GA-RXRX-C6	078-05GJ-RXRX-C6	+079-05GA-RXRX-C6
500V	0-500V	+/-077-05GA-SFSF-C6	078-05GJ-SFSF-C6	+079-05GA-SFSF-C6
600V	0-600V	+/-077-05GA-SJSJ-C6	078-05GJ-SJSJ-C6	+079-05GA-SJSJ-C6
750V	0-750V	077-05GA-SMSM-C6	078-05GJ-SMSM-C6	079-05GA-SMSM-C6

For A.C. rectified non-RMS compensated meter please replace the -05G in the product code with -05W.

Product Codes – Transformer Rated 50/60HZ (Accuracy ±1%) 0.8VA @150V***

150V	0-300V	+/-077-05GA-PZRX-C6	078-05GJ-PZRX-C6	+079-05GA-PZRX-C6
150V	0-600V	+/-077-05GA-PZSJ-C6	078-05GJ-PZSJ-C6	+079-05GA-PZSJ-C6
150V	0-750V	+/-077-05GA-PZSM-C6	078-05GJ-PZSM-C6	+079-05GA-PZSM-C6
150V	0-3000V	+/-077-05GA-PZUA-C6	078-05GJ-PZUA-C6	+079-05GA-PZUA-C6
150V	0-5250V	+/-077-05GA-PZUL-C6	078-05GJ-PZUL-C6	+079-05GA-PZUL-C6
150V	0-6000V	+/-077-05GA-PZUP-C6	078-05GJ-PZUP-C6	+079-05GA-PZUP-C6
150V	0-9000V	+/-077-05GA-PZUY-C6	078-05GJ-PZUY-C6	+079-05GA-PZUY-C6
150V	0-15KV	+/-077-05GA-PZWC-C6	078-05GJ-PZWC-C6	+079-05GA-PZWC-C6
150V	0-18KV	+/-077-05GA-PZWD-C6	078-05GJ-PZWD-C6	+079-05GA-PZWD-C6
150V	0-45KV	+/-077-05GA-PZWJ-C6	078-05GJ-PZWJ-C6	+079-05GA-PZWJ-C6
250V	0-600V	+/-077-05GA-RSSJ-C6	078-05GJ-RSSJ-C6	+079-05GA-RSSJ-C6

For A.C. rectified non-RMS compensated meter please replace the -05G in the product code with -05W.

Product Codes – Expanded Scale - Moving Coil Zener Diode*** (Accuracy ±0.3% of mid scale value) Self contained, 20-1000Hz

110-130V	110-130V	077-05YA-PNPN-C6	078-05YJ-PNPN-C6	079-05YA-PNPN-C6
110-130V	TO SUIT P.T	077-05YA-PN**-C6	078-05YJ-PN**-C6	079-05YA-PN**-C6

Product Codes – Instantaneous A.C. Voltmeter*** with Instantaneous Maximum Reading Slave Pointer

150V	TO SUIT P.T.	077-05XA-PZ**-C6		
250V	TO SUIT P.T	077-05XA-RS**-C6		
300V	TO SUIT P.T	077-05XA-RX**-C6		

077 moving iron ammeters and voltmeters available as listed above.

• UL recognised File # E87815
+ CSA Approved File # LR52592

* Other scales are available
** Specify scale required
*** Case types 077/078/079 use 10-32 UNF terminals. For M5 screw clamp terminals stipulate case type 075



D.C. Ammeter

Intrinsically Safe Milliammeters (Accuracy ±1%) ISSEP Certified	
Rating	Std Case Catalogue No.
1mA D.C.	077-11AF-FA**
5mA D.C.	077-11AF-FX**
10mA D.C.	077-11AF-HA**
20mA D.C.	077-11AF-HF**
4/20mA D.C.	077-11RFHG**

** State scale marking as required

D.C. Ammeters

Product Codes – Self Contained (Accuracy ±1%)* ** *

Rating	Scaling*	4½" Square Flange		8¾" Square Flange
		Standard Case Catalogue No.	Sealed Case Hi-Shock Catalogue No.	Standard Case Catalogue No.
0-200µA	0-200µA	•/+077-05AA-EAEA	078-05AJ-EAEA	•079-05AA-EAEA
0-300µA	0-300µA	•/+077-05AA-EEEE	078-05AJ-EEEE	•079-05AA-EEEE
0-500µA	0-500µA	•/+077-05AA-EMEM	078-05AJ-EMEM	•079-05AA-EMEM
0-800µA	0-800µA	•/+077-05AA-EWEW	078-05AJ-EWEW	•079-05AA-EWEW
0-1mA	0-1mA	•/+077-05AA-FAFA	078-05AJ-FAFA	•079-05AA-FAFA
0-2mA	0-2mA	•/+077-05AA-FGFG	078-05AJ-FGFG	•079-05AA-FGFG
0-5mA	0-5mA	•/+077-05AA-FXFX	078-05AJ-FXFX	•079-05AA-FXFX
0-10mA	0-10mA	•/+077-05AA-HAHA	078-05AJ-HAHA	•079-05AA-HAHA
0-20mA	0-20mA	•/+077-05AA-HFHF	078-05AJ-HFHF	•079-05AA-HFHF
0-30mA	0-30mA	•/+077-05AA-HMHM	078-05AJ-HMHM	•079-05AA-HMHM
0-50mA	0-50mA	•/+077-05AA-HXHY	078-05AJ-HXHY	•079-05AA-HXHY
0-100mA	0-100mA	•/+077-05AA-JRJR	078-05AJ-JRJR	•079-05AA-JRJR
0-200mA	0-200mA	•/+077-05AA-KAKA	078-05AJ-KAKA	•079-05AA-KAKA
0-300mA	0-300mA	•/+077-05AA-KGKG	078-05AJ-KGKG	•079-05AA-KGKG
0-500mA	0-500mA	•/+077-05AA-KMKM	078-05AJ-KMKM	•079-05AA-KMKM
0-800mA	0-800mA	•/+077-05AA-KWKW	078-05AJ-KWKW	•079-05AA-KWKW
0-1A	0-1A	•/+077-05AA-LALA	078-05AJ-LALA	•079-05AA-LALA
0-5A	0-5A	•/+077-05AA-LSLS	078-05AJ-LSLS	•079-05AA-LSLS
0-10A	0-10A	•/+077-05AA-MTMT	078-05AJ-MTMT	•079-05AA-MTMT
0-15A	0-15A	•/+077-05AA-NDND	078-05AJ-NDND	•079-05AA-NDND
0-20A	0-20A	•/+077-05AA-NGNG	078-05AJ-NGNG	•079-05AA-NGNG
0-30A	0-30A	•/+077-05AA-NLNL	078-05AJ-NLNL	•079-05AA-NLNL

Product Codes – Milliammeters - Suppressed Zero, No zero set unless specified****

1/5mA	To Suit	•/+077-05RA-GM**	078-05RJ-GM**	•079-05RA-GM**
4/20mA	To Suit	•/+077-05RA-HG**	078-05RJ-HG**	•079-05RA-HG**
10/50mA	To Suit	•/+077-05RA-HZ**	078-05RJ-HZ**	•079-05RA-HZ**

Product Codes – Shunt Rated (Accuracy ±1%)* ** *

50mV (4mA)	To suit	•/+077-05AA-EY**	078-05AJ-EY**	079-05AA-EY**
50-0-50mV	shunt	•/+077-05CA-GB**	078-05CJ-GB**	079-05CA-GB**
100mV (4mA)	rating	•/+077-05AA-GB**	078-05AJ-GB**	079-05AA-GB**
100-0-100mV		•/+077-05CA-GM**	078-05CJ-GM**	079-05CA-GM**

Product Codes – Zero Left For Use With 50mV Shunts And 0.05 Ohm Shunt Leads*** & ****

50mV	0-15A	•/+077-05AA-EYND	078-05AJ-EYND	079-05AA-EYND
50mV	0-20A	•/+077-05AA-EYNG	078-05AJ-EYNG	079-05AA-EYNG
50mV	0-30A	•/+077-05AA-EYNL	078-05AJ-EYNL	079-05AA-EYNL
50mV	0-40A	•/+077-05AA-EYNP	078-05AJ-EYNP	079-05AA-EYNP
50mV	0-75A	•/+077-05AA-EYPB	078-05AJ-EYPB	079-05AA-EYPB
50mV	0-100A	•/+077-05AA-EYPK	078-05AJ-EYPK	079-05AA-EYPK
50mV	0-150A	•/+077-05AA-EYPZ	078-05AJ-EYPZ	079-05AA-EYPZ
50mV	0-200A	•/+077-05AA-EYRL	078-05AJ-EYRL	079-05AA-EYRL
50mV	0-300A	•/+077-05AA-EYRX	078-05AJ-EYRX	079-05AA-EYRX
50mV	0-400A	•/+077-05AA-EYSC	078-05AJ-EYSC	079-05AA-EYSC
50mV	0-500A	•/+077-05AA-EYSF	078-05AJ-EYSF	079-05AA-EYSF
50mV	0-750A	•/+077-05AA-EYSM	078-05AJ-EYSM	079-05AA-EYSM
50mV	0-1000A	•/+077-05AA-EYSS	078-05AJ-EYSS	079-05AA-EYSS
50mV	0-1200A	•/+077-05AA-EYSU	078-05AJ-EYSU	079-05AA-EYSU
50mV	0-1500A	•/+077-05AA-EYTC	078-05AJ-EYTC	079-05AA-EYTC
50mV	0-2000A	•/+077-05AA-EYTM	078-05AJ-EYTM	079-05AA-EYTM
50mV	0-3000A	•/+077-05AA-EYUA	078-05AJ-EYUA	079-05AA-EYUA

- UL recognised File # E87815
- + CSA Approved File # LR52592
- Specify shunt lead resistance value if in excess of 0.05 OHMS for calibration purposes.
- D.C. shunt rated ammeters have thermistor circuit ambient temperature compensation.
- Separate shunt and shunt leads are not included.
- * Other scales are available
- ** Specify scale required.
- *** Other mV ratings and scale options available upon request.
- **** Case types 077/078/079 use 10-32 UNF terminals. For M5 screw clamp terminals stipulate case type 075.

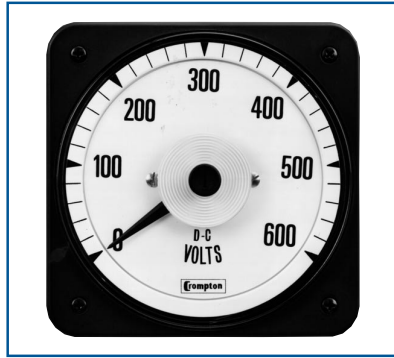

D.C. Voltmeter

D.C. Voltmeters

Product Codes – Sensitivity 1000 ohms / Volt (Accuracy ±1%)* **

Rating	Scaling*	4½" Square Flange		8¾" Square Flange
		Standard Case Catalogue No.	Sealed Case Hi-Shock Catalogue No.	Standard Case Catalogue No.
50mV to 800V	TO SUIT	•/+077-05VA-**	078-05VJ-**	079-05VA-**
0-15V	0-15V	•/+077-05VA-NDND	078-05VJ-NDND	079-05VA-NDND
0-30V	0-30V	•/+077-05VA-NLNL	078-05VJ-NLNL	079-05VA-NLNL
0-50V	0-50V	•/+077-05VA-NTNT	078-05VJ-NTNT	079-05VA-NTNT
0-75V	0-75V	•/+077-05VA-PBPB	078-05VJ-PBPB	079-05VA-PBPB
0-150V	0-150V	•/+077-05VA-PZPZ	078-05VJ-PZPZ	079-05VA-PZPZ
0-300V	0-300V	•/+077-05VA-RXRX	078-05VJ-RXRX	079-05VA-RXRX
0-400V	0-400V	•/+077-05VA-SCSC	078-05VJ-SCSC	079-05VA-SCSC
0-500V	0-500V	•/+077-05VA-SFSF	078-05VJ-SFSF	079-05VA-SFSF
0-600V	0-600V	•/+077-05VA-SJSJ	078-05VJ-SJSJ	079-05VA-SJSJ
0-750V	0-750V	077-05VA-SMSM	078-05VJ-SMSM	079-05VA-SMSM
0-800V	0-800V	077-05VA-SNSN	078-05VJ-SNSN	079-05VA-SNSN

Product Codes – Zero Centre - Sensitivity 2000 Ohms / Volt (Accuracy ±1%)* **

150-0-150V	150-0-150V	•/+077-05NA-RXRX	078-05NJ-RXRX	079-05NA-RXRX
300-0-300V	300-0-300V	•/+077-05NA-SJSJ	078-05NJ-SJSJ	079-05NA-SJSJ
500-0-500V	500-0-500V	•/+077-05NA-SSSS	078-05NJ-SSSS	079-05NA-SSSS
600-0-600V	600-0-600V	•/+077-05NA-SUSU	078-05NJ-SUSU	079-05NA-SUSU

Product Code – Suppressed Zero***

1 - 5V	TO SUIT	•/+077-05S-LM	078-05S-LM	•079-05S-LM
--------	---------	---------------	------------	-------------

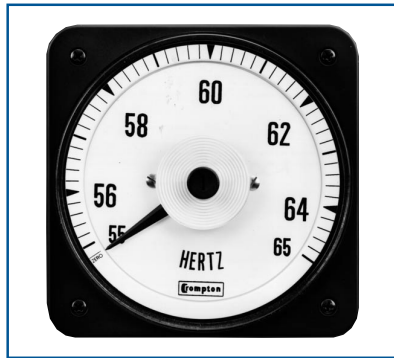

Frequency Meter

Frequency Meters

Product Code –120V Self Contained***

Rating	Scaling*	4½" Square Flange		8¾" Square Flange
		Standard Case Catalogue No.	Sealed Case Hi-Shock Catalogue No.	Standard Case Catalogue No.
50Hz+/-0.15	45-55Hz	•/+077-41LA-PNAG-AG	078-41LJ-PNAG-AG	•079-41LA-PNAG-AG
50Hz+/-0.15	46-54Hz	•/+077-41LA-PNAH-AH	078-41LJ-PNAH-AH	•079-41LA-PNAH-AH
50Hz+/-0.25	45-65Hz	•/+077-41LA-PNAJ-AJ	078-41LJ-PNAJ-AJ	•079-41LA-PNAJ-AJ
60Hz+/-0.25	50-70Hz	•/+077-41LA-PNAL-AL	078-41LJ-PNAL-AL	•079-41LA-PNAL-AL
60Hz+/-0.15	55-65Hz	•/+077-41LA-PNAN-AN	078-41LJ-PNAN-AN	•079-41LA-PNAN-AN
60Hz+/-0.15	56-64Hz	•/+077-41LA-PNAO-AO	078-41LJ-PNAO-AO	•079-41LA-PNAO-AO
60Hz+/-0.08	58-62Hz	•/+077-41LA-PNAT-AG	078-41LJ-PNAG-AG	•079-41LA-PNAG-AG
400Hz+/-1.3	350-450Hz	•/+077-41LA-PNBH-BH	078-41LJ-PNBH-BH	•079-41LA-PNBH-BH
400Hz+/-1.25	360-440Hz	•/+077-41LA-PNBI-BI	078-41LJ-PNBI-BI	•079-41LA-PNBI-BI
400Hz+/- 0.8	380-420Hz	•/+077-41LA-PNBK-BK	078-41LJ-PNBK-BK	079-41LA-PNBK-BK

Alternative voltage rating 200-250V use code RN instead of PN
 Alternative voltage rating 380-480V use code SE instead of PN
 • UL recognised File number E87815

* Other scales are available
 ** Specify scale required
 *** Case types 077/078/079 use 10-32 UNF terminals. For M5 screw clamp terminals stipulate case type 075



A.C. Maximum Demand Ammeter

Thermal Maximum Demand Directly Heated Element Type

Indicates the maximum average ampere demand of a system. A red resettable slave pointer is driven upscale by the indicating pointer to show maximum average value of current since the previous setting. 4 1/2" square flange.

Specification

Burden:	3.5VA with limiting C.T., 2.5VA without limiting C.T.
Time lag:	15 minutes
Accuracy:	3% 50 or 60Hz

Product Codes

5/6A with 20% overload and internal limiting C.T.	•077-16EU-LS**
5A - without overload, with internal limiting C.T.	•077-16EU-LS** - NO



Thermal Instantaneous Maximum Demand Ammeter

Thermal / Instantaneous Maximum Demand Ammeter (MDA)

Allows instantaneous values of current to be read independently of the thermal indicator. This meter combines a thermal movement, with a rugged shortscale iron vane indicator.

Specification

Burden:	4VA with limiting C.T., 3VA without limiting C.T.
Time Lag:	15 mins
Accuracy:	3% MDA, 2% Iron Vane 50 or 60Hz

Product Codes

Thermal / Instantaneous MDA	
5/6A with 20% overload scale and internal limiting C.T.	•077-16FU-LS**
5A - without 20% overload scale, with internal limiting C.T.	•077-16FU-LS** - NO
Dual Range - Thermal Instantaneous	
3/6A - with 20% overload scale	•077-16FU-LK**
2.5/5A - without 20% overload scale	•077-16FU-LK** - NO
6/12A with 20% overload scale and internal limiting C.T.	•077-16FU-LV**
5/10A - without 20% overload scale with internal limiting C.T.	•077-16FU-LV** - NO

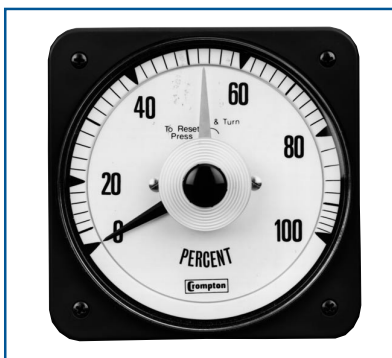

Instantaneous Maximum Demand Ammeter

Instantaneous Maximum Demand Ammeter with Slave Pointer

Designed to be compatible with other 4 1/2" switchboard meters. This instrument enhances panel appearance and indicates maximum instantaneous values of load current. The meter incorporates a longscale high torque taut band iron vane movement to drive the red slave pointer.

Specification

Burden:	5VA, Accuracy -1% 50 or 60Hz
---------	------------------------------

Product Code

5A - without overload scale	077-08DA-LS**
-----------------------------	---------------

** Specify scale required
 • UL recognised



A.C. Wattmeters & Varmeters

The Crompton 70 series of A.C. Wattmeters and Varmeters incorporate a DC moving coil taut band indicator with the Crompton designed micro-circuit Watt transducer PCB to read power on single phase or three phase systems. Varmeters can be supplied with internal phase shifter or with external phase shifter if preferred. In the interest of standardisation, preferred Wattmeter scale marking for common current and voltage transformers are listed on the following pages. Instruments may be supplied with zero left or center zero scales at the same list price.

Scaling

Since Wattmeter and Varmeter current circuits are frequently connected in series, they should have equal current carrying capacity. This means that to assure equality the sum of the left and right end-scale values of the Varmeters should be equal to or greater than the full scale value of the Wattmeter (or the higher of the end-scale values if center or offset zero). Instruments 10,000 kilowatts and over are marked in megawatts. Center zero or offset zero Watt and Varmeters are marked "IN" for left deflection and "OUT" for right deflection. Preferred scales may be calculated for Wattmeters and varmeters not listed on the charts. Scale Watts must be one of the standard full scale dial markings shown on the charts.

Calibration

For full load value of Watts or Vars, assuming unity power factor:

1ph 2 wire Watts = amps x volts

3ph 3 wire Watts = amps x line to line volts x $\sqrt{3}$

3ph 4 wire Watts = amps x line to neutral volts x 3

Minimum scale values are obtained by multiplying resultant Watts using above formula x 0.7 and selecting next highest standard scale.

For maximum scale value multiply x 1.3 and select next lowest standard.

If scale calculates to an exact listed value use it rather than the next higher or lower value.

Note: When ordering Wattmeters and Varmeters specify C.T. ratio, V.T. ratio and required scale.

Specification

Burden per element:	Current circuit: 2VA Voltage circuit: 1VA
Accuracy Class:	1.0
Ambient range:	0° to +60°C, (32° to 140°F) standard calibration 20°C (68°F)
Ambient influence:	0.05% per 1°C maximum
Overloads-current:	10 x rating for 5 seconds., 1.2 x continuously
Voltage:	2 x rating for 5 seconds., 1.2 x continuously
Voltage influence:	Accuracy maintained, 80-110% rated voltage
Power Factor influence:	Accuracy maintained 0.1 lag to 0.1 lead
Enclosure code:	077: IP54 optional IP55 078: IP67 079: IP54 optional IP55
Response Time:	077,078: approximately 2.5 seconds 079: approximately 3.5 seconds
Dielectric test:	Live parts to case including panel 2600V RMS for 1 minute

070 Series ANSI Switchboard Meters



Wattmeter/Varmeter Scale Selector Guide

PRIMARY POTENTIAL TRANSFORMER VOLTAGE SYSTEM VOLTAGE 3 PHASE 3 WIRE (L-L)		120 (1:1)	208 (1.73:1)	240 (2:1)	480 (4:1)	600 (5:1)	2400 (20:1)	3600 (30:1)	4200 (35:1)	4800 (40:1)	6000 (50:1)	7200 (60:1)	8400 (70:1)
SYSTEM VOLTAGE 3 PHASE 4 WIRE (L-N)		120	208	240	480	600	2400	3600	4200	4800	6000	7200	8400
CURRENT TRANSFORMER		69	120	139	277	347	1390	2100	2400	2770	3500	4160	4800
RATIO	NORMAL	5KW	10KW	10KW	20KW	25KW	100KW	150KW	175KW	200KW	250KW	300KW	350KW
25/5	MAX.	6	10	12	25	30	120	200	200	250	300	400	450
(5:1)	MIN.	3	5	6	12.5	15	60	100	100	125	150	200	225
RATIO	NORMAL	10KW	20KW	20KW	40KW	50KW	200KW	300KW	350KW	400KW	500KW	600KW	700KW
50/5	MAX.	12	20	25	50	60	250	400	450	500	600	800	900
(10:1)	MIN.	6	10	12.5	25	30	125	200	250	250	300	400	450
RATIO	NORMAL	15KW	25KW	30KW	60KW	75KW	300KW	500KW	500KW	600KW	750KW	900KW	1000KW
75/5	MAX.	20	30	40	80	100	400	600	700	800	1000	1200	1200
(15:1)	MIN.	10	15	20	40	50	200	300	350	400	500	600	600
RATIO	NORMAL	20KW	30KW	40KW	75KW	100KW	400KW	600KW	700KW	800KW	1000KW	1200KW	1200KW
100/5	MAX.	25	40	50	100	120	500	800	900	1000	1200	1500	1500
(20:1)	MIN.	12.5	20	25	50	60	250	400	450	500	600	750	750
RATIO	NORMAL	30KW	50KW	50KW	100KW	150KW	600KW	800KW	1000KW	1200KW	1500KW	1800KW	2000KW
150/5	MAX.	40	70	75	150	200	800	1200	1200	1500	2000	2400	2500
(30:1)	MIN.	20	35	35	75	100	400	600	600	750	1000	1000	1250
RATIO	NORMAL	40KW	75KW	75KW	150KW	200KW	800KW	1200KW	1200KW	1500KW	2000KW	2500KW	3000KW
200/5	MAX.	50	80	100	200	250	1000	1500	1500	2000	2500	3000	3500
(40:1)	MIN.	25	40	50	100	125	500	750	750	1000	1250	1500	1500
RATIO	NORMAL	70KW	100KW	100KW	200KW	300KW	1200KW	1500KW	2000KW	2500KW	3000KW	3500KW	4500KW
300/5	MAX.	75	120	150	300	400	1500	2000	2500	3000	4000	4000	5000
(60:1)	MIN.	35	60	75	150	200	750	1000	1250	1500	2000	2000	2500
RATIO	NORMAL	75KW	125KW	150KW	300KW	400KW	1500KW	2500KW	3000KW	3000KW	4000KW	5000KW	6000KW
400/5	MAX.	100	150	200	400	500	2000	3000	3600	4000	5000	6000	7000
(80:1)	MIN.	50	75	100	200	250	1000	1500	1500	2000	2500	3000	3500
RATIO	NORMAL	125KW	200KW	200KW	450KW	600KW	2000KW	3000KW	4000KW	5000KW	6000KW	7500KW	8000KW
600/5	MAX.	150	250	300	600	800	3000	4000	5000	6000	8000	8000	10MW
(120:1)	MIN.	75	125	150	300	400	1500	2000	2500	3000	4000	4000	5000KW
RATIO	NORMAL	150KW	250KW	300KW	600KW	800KW	3000KW	5000KW	6000KW	6000KW	8000KW	10MW	12MW
800/5	MAX.	200	350	400	800	1000	4000	6000	7500	8000	10MW	12	15
(160:1)	MIN.	100	175	200	400	500	2000	3000	3000	4000	5000KW	6000KW	7500KW
RATIO	NORMAL	200KW	350KW	400KW	800KW	1000KW	4000KW	6000KW	6000KW	8000KW	10MW	12MW	15MW
1000/5	MAX.	250	450	500	1000	1200	5000	8000	8000	10MW	12	15	18
(200:1)	MIN.	125	225	250	500	600	2500	4000	4000	5000KW	6000KW	7500KW	10
RATIO	NORMAL	250KW	400KW	500KW	1000KW	1200KW	5000KW	7000KW	8000KW	10MW	12MW	15MW	10MW
1200/5	MAX.	300	500	600	1200	1500	6000	8000	10MW	12	15	18	20
(240:1)	MIN.	150	250	300	600	750	3000	4000	5000KW	6000KW	7500KW	10	10
RATIO	NORMAL	300KW	500KW	600KW	1200KW	1500KW	6000KW	10MW	10MW	12MW	15MW	20MW	20MW
1500/5	MAX.	400	700	750	1500	2000	8000	12	12	15	20	20	25
(300:1)	MIN.	200	350	375	1000	1000	4000	6000KW	6000KW	7500KW	10	10	12.5
RATIO	NORMAL	400KW	750KW	800KW	1600KW	2000KW	8000KW	12MW	12MW	15MW	20MW	25MW	30MW
2000/5	MAX.	500	800	1000	2000	2500	10MW	15	15	20	25	30	35
(400:1)	MIN.	250	400	500	750	1250	5000	7500KW	7500KW	10	12.5	15	20
RATIO	NORMAL	750KW	1000KW	1200KW	2000KW	3000KW	12MW	18MW	20MW	25MW	30MW	35MW	40MW
3000/5	MAX.	800	1200	1500	3000	4000	15	20	25	30	40	40	50
(600:1)	MIN.	400	600	750	1500	2000	7500KW	10	12.5	15	20	20	25
RATIO	NORMAL	800KW	1200KW	1500KW	3000KW	4000KW	15MW	20MW	25MW	30MW	40MW	50MW	50MW
4000/5	MAX.	1000	1500	2000	4000	5000	20	30	30	40	50	60	75
(800:1)	MIN.	500	750	1000	2000	2500	10	15	15	20	25	30	40
RATIO	NORMAL	1000KW	1500KW	2000KW	4000KW	5000KW	20MW	30MW	20MW	40MW	50MW	60MW	75MW
5000/5	MAX.	1250	2000	2500	5000	6000	25	40	25	50	60	80	80
(1000:1)	MIN.	500	1000	1250	2500	3000	12.5	20	12.5	25	30	40	40
RATIO	NORMAL	1200KW	2000KW	2500KW	5000KW	6000KW	25MW	35MW	40MW	50MW	60MW	60MW	80MW
6000/5	MAX.	1500	2500	3000	3000	8000	30	40	50	60	80	80	100
(1200:1)	MIN.	750	1250	1500	1500	4000	15	20	25	30	40	40	50

070 Series ANSI Switchboard Meters



Wattmeter/Varmeter Scale Selector Guide

PRIMARY POTENTIAL TRANSFORMER VOLTAGE SYSTEM VOLTAGE	12KV (100:1)	14.4KV (120:1)	24KV (200:1)	34.5KV (300:1)	38KV (330:1)	46KV (400:1)	92KV (800:1)	115KV (1000:1)	138KV (1200:1)	345KV (3000:1)	765KV (6000:1)	
3 PHASE 3 WIRE (L-L) SYSTEM VOLTAGE	12KV	14.4KV	24KV	34.5KV	38KV	46KV	92KV	115KV	138KV	345KV	765KV	
3 PHASE 4 WIRE (L-N) CURRENT TRANSFORMER	6900	8300	13.8KV	20KV	22KV	26.5KV	53KV	66KV	80KV	200KV	440KV	
RATIO	NORMAL	500KW	600KW	1000KW	1500KW	1500KW	1500KW	3000KW	5000KW	6000KW	15MW	30MW
25/5	MAX.	650	800	1200	1500	2000	2500	200	200	250	300	400
(5:1)	MIN.	325	400	600	750	1000	1250	100	100	125	150	200
RATIO	NORMAL	1000KW	1200KW	2000KW	3000KW	3000KW	3500KW	8000KW	10MW	12MW	30MW	60MW
50/5	MAX.	1200	1500	2500	3500	4000	5000	10MW	12	15	35	80
(10:1)	MIN.	600	750	1250	1750	2000	2500	5000KW	6000KW	7500KW	15	40
RATIO	NORMAL	1500KW	1800KW	3000KW	4000KW	5000KW	5000KW	10MW	15MW	15MW	45MW	100MW
75/5	MAX.	2000	2000	4000	5000	6000	7500	15	15	20	50	125
(15:1)	MIN.	1000	1000	2000	2500	3000	3000	7500KW	7500KW	10	25	50
RATIO	NORMAL	2000KW	2500KW	4000KW	6000KW	6000KW	7500KW	15MW	20MW	25MW	60MW	125MW
100/5	MAX.	2500	3000	5000	7500	8000	10MW	20	25	30	70	150
(20:1)	MIN.	1250	1500	2500	3000	4000	5000KW	10	12.5	15	35	75
RATIO	NORMAL	3000KW	3500KW	6000KW	10MW	10MW	10MW	20MW	30MW	35MW	90MW	200MW
150/5	MAX.	4000	4000	4000	10	12	15	30	35	40	100	250
(30:1)	MIN.	2000	2000	2000	5000KW	6000KW	7500KW	15	15	20	50	100
RATIO	NORMAL	4000KW	4500KW	8000KW	12MW	12MW	15MW	30MW	35MW	50MW	100MW	250MW
200/5	MAX.	5000	6000	5000	15	15	20	40	50	60	150	300
(40:1)	MIN.	2500	3000	2500	7500KW	7500KW	10	20	25	30	75	150
RATIO	NORMAL	6000KW	7000KW	12MW	18MW	18MW	20MW	45MW	60MW	75MW	150MW	400MW
300/5	MAX.	8000	8000	15	20	25	30	60	75	80	200	500
(60:1)	MIN.	4000	4000	7.5	10	12.5	15	30	30	40	100	250
RATIO	NORMAL	8000KW	10MW	15MW	24MW	25MW	30MW	60MW	80MW	100MW	200MW	500MW
400/5	MAX.	10MW	12	20	30	30	40	80	100	120	300	600
(80:1)	MIN.	5000KW	6000KW	10	15	15	20	40	50	60	150	300
RATIO	NORMAL	12MW	15MW	25MW	35MW	40MW	45MW	90MW	100MW	150MW	350MW	800KW
600/5	MAX.	15	18	30	40	50	60	120	150	180	450	1000
(120:1)	MIN.	7500KW	10	15	20	25	30	60	75	75	225	500
RATIO	NORMAL	15MW	20MW	30MW	50MW	50MW	60MW	120MW	150MW	200MW	500MW	1000MW
800/5	MAX.	20	25	40	60	60	80	150	200	200	600	1200
(160:1)	MIN.	10	12.5	20	30	30	40	75	100	100	300	600
RATIO	NORMAL	20MW	25MW	40MW	50MW	60MW	75MW	150MW	200MW	250MW	600MW	1200MW
1000/5	MAX.	25	30	50	60	80	100	200	250	300	750	1500
(200:1)	MIN.	12.5	15	25	30	40	50	100	125	150	300	750
RATIO	NORMAL	25MW	30MW	50MW	60MW	80MW	100MW	175MW	250MW	300MW	750MW	1500MW
1200/5	MAX.	30	35	60	80	100	120	200	300	350	900	2000
(240:1)	MIN.	15	20	30	40	50	60	100	150	175	450	1000
RATIO	NORMAL	30MW	35MW	60MW	75MW	100MW	120MW	250MW	300MW	350MW	900MW	2000MW
1500/5	MAX.	40	40	80	100	120	150	300	350	450	1000	2500
(300:1)	MIN.	20	20	40	50	60	75	150	175	225	500	1250
RATIO	NORMAL	40MW	50MW	80MW	100MW	120MW	150MW	300MW	400MW	5000MW	1000MW	2500MW
2000/5	MAX.	50	60	100	150	150	200	400	500	600	1500	3000
(400:1)	MIN.	25	30	50	75	75	100	200	250	300	750	1500
RATIO	NORMAL	60MW	75MW	100MW	150MW	200MW	200MW	400MW	600MW	700MW	1500MW	3500MW
3000/5	MAX.	80	80	150	200	250	300	500	750	900	2000	5000
(600:1)	MIN.	40	40	75	100	125	150	250	350	450	1000	2500
RATIO	NORMAL	80MW	100MW	150MW	200MW	250MW	300MW	500MW	800MW	1000MW	2000MW	500MW
4000/5	MAX.	100	125	200	300	300	400	800	1000	1200	3000	6000
(800:1)	MIN.	50	60	100	150	150	200	400	500	600	1500	3000
RATIO	NORMAL	100MW	125MW	200MW	250MW	300MW	4000MW	750MW	1000MW	1200MW	3000MW	6000MW
5000/5	MAX.	120	150	250	300	400	500	1000	1200	1500	3500	8000
(1000:1)	MIN.	60	75	125	150	200	250	500	600	750	1750	4000
RATIO	NORMAL	120MW	150MW	250MW	350KW	400MW	450MW	1000MW	1200MW	1500MW	3500MW	8000MW
6000/5	MAX.	150	175	300	400	500	600	1200	1500	1750	4000	10000
(1200:1)	MIN.	75	80	150	200	250	300	600	750	800	2000	5000

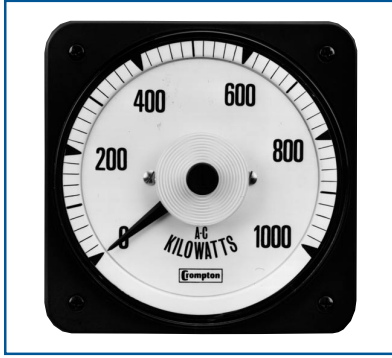

A.C. Wattmeter

A.C. Wattmeters

Product Codes – 1 element, transformer rated. 50/60Hz.
Taut Band. Integral transducer. Accuracy 1.0%. 50/60Hz

Measured System		Scales	4 1/2" Square Flange		8 3/4" Square Flange		
Phases	Wires		Standard Case Catalogue No.	Sealed Case Hi-Shock Catalogue No.	Standard Case Catalogue No.		
1	2	5	120V	TO SUIT	•/+077-215A-QQ**	078-215J-QQ**	•079-215A-QQ**
1	2	5	240V	TO SUIT	077-215A-QS**	078-215J-QS**	079-215A-QS**

For connection diagram please see Fig. 21 page 60.

Product Codes – 2 element, transformer rated. 50/60Hz.
Taut Band. Integral transducer. Accuracy 1.0%. 50/60Hz

3	3	5	120V	TO SUIT	•/+077-218A-QQ**	078-218J-QQ**	•079-218A-QQ**
3	3	5	208V	TO SUIT	•/+077-218A-QR**	078-218J-QR**	•079-218A-QR**
3	3	5	240V	TO SUIT	•/+077-218A-QS**	078-218J-QS**	079-218A-QS**
3	3	5	380V	TO SUIT	•/+077-218A-QX**	078-218J-QX**	079-218A-QX**
3	3	5	480V	TO SUIT	•/+077-218A-QT**	078-218J-QT**	079-218A-QT**

For connection diagram please see Fig. 25 page 60.

Product Codes – 2 1/2 element, transformer rated. 50/60Hz.
Taut Band. Integral transducer. Accuracy 1.0%. 50/60Hz

3	4	5	69V	TO SUIT	•/+077-219A-QL**	078-219J-QL**	•079-219A-QL**
3	4	5	120V	TO SUIT	•/+077-219A-QQ**	078-219J-QQ**	•079-219A-QQ**
3	4	5	277V	TO SUIT	077-219A-QY**	078-219J-QY**	079-219A-QY**
3	4	5	346V	TO SUIT	077-219A-QZ**	078-219J-QZ**	079-219A-QZ**

For connection diagram please see Fig. 28 page 60.

Product Codes – Phase Shifting Transformers

For use with above Wattmeters, when VAR measurement with external phase shifter is required.

3	3	120V		855-956A-PR	855-956J-PR	855-956A-PR
3	4	120V		855-957A-PR	855-957J-PR	855-957A-PR
3	4	69V		855-957A-NZ	855-957J-NZ	855-957A-NZ

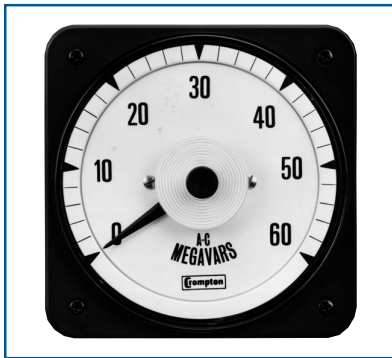

A.C. Varmeter

A.C. Varmeters

Product Codes – 2 element, transformer rated. 50/60Hz.
Taut Band. Integral transducer. Accuracy 1.0%. 50/60Hz

3	3	5	120V	TO SUIT	•/+077-31LA-QQ**	078-31LJ-QQ**	
3	3	5	208V	TO SUIT	•/+077-31LA-QR** C6	078-31LJ-QR**	
3	3	5	240V	TO SUIT	077-31LA-QS**	078-31LJ-QS**	
3	3	5	380V	TO SUIT	077-31LA-QX**	078-31LJ-QX**	
3	3	5	480V	TO SUIT	077-31LA-QT**	078-31LJ-QT**	

For connection diagram please see Fig. 32 page 61.

Product Codes – 2 1/2 element, transformer rated. 50/60Hz.
Taut Band. Integral transducer. Accuracy 1.0%. 50/60Hz

3	4	5	120V	TO SUIT	•/+077-31UA-QQ**	078-31UJ-QQ**	•079-31UA-QQ**
3	4	5	208V	TO SUIT	077-31UA-QR**	078-31UJ-QR**	•079-31UA-QR**
3	4	5	480V	TO SUIT	077-31UA-QT**	078-31UJ-QT**	079-31UA-QT**

For connection diagram please see Fig. 32 page 61.

- UL recognised File # E87815 + CSA Approved File # LR52592
- ** Specify C.T. (Current Transformer) and V.T. (Voltage Transformer) ratios if used, and preferred scale at time of ordering.



RTD Temperature Meter

RTD Temperature Meters*

Product Codes – Accuracy 1.0% of span.

Self-contained for 10 Ohm copper or 100 Ohm platinum RTD. (Resistance Temperature Detector) - Specify copper or platinum at time of ordering.

Rating	Scaling*	4½" Square Flange	
		Standard Case Catalogue No.	Sealed Case Hi-Shock Catalogue No.
110/130V 50/60Hz	20-140°C	077-45RA-**QF-PQ	078-45RJ-**QF-PQ
110/130V 50/60Hz	0-150°C	077-45RA-**QE-PQ	078-45RJ-**QE-PQ
110/130V 50/60Hz	0-200°C	077-45RA-**QG-PQ	078-45RJ-**QG-PQ

For connection diagrams please see Fig. 17 page 59.

Thermocouple Temperature Meters

Product Code – Accuracy 1% of span.

Suitable for type J and K. Cold junction compensation and thermocouple break indication is provided. Specify type J or K and temperature at time of ordering.

Rating	4½" Square Flange	
	Standard Case Catalogue No.	
110/130V 50/60Hz	077-45TA-**PM	

For connection diagrams please see Fig. 18 page 59.

Tap Position Indicator

Product Code

To show transformer tap, hoist or valve position using 3 wire system for 1-18 tap positions using 400 Ohm steps.

Rating	Scaling*	4½" Square Flange		8¼" Square Flange
		Standard Case Catalogue No.	Sealed Case Hi-Shock Catalogue No.	Standard Case Catalogue No.
110/220/240V 50/60Hz	1-18 taps	077-45P-	Not available	Not available

For connection diagrams please see Fig. 20 page 60.

Select nearest higher rated voltmeter and specify requirement

- UL recognised File # E87815
- JT for type J, KT for type K thermocouple
- * Other ranges available upon request - Consult Factory.
- ** RI for 10 ohm Copper or R2 for 100ohm platinum.
- *** Specify input and scale



Elapsed Time Meter

Elapsed Time Meters

Product Codes – 99,999.99 hours, non reset. Burden 2.5VA. 50 or 60Hz

Synchronous motor running time meter with a running indicator.

Rating	4½" Square Flange		8¾" Square Flange
	Standard Case Catalogue No.	Sealed Case Hi-Shock Catalogue No.	Standard Case Catalogue No.
110/130V 50Hz	•077-155A-PNZH-C5	078-155J-PNZH-C5	Not available
200/250V 50Hz	•077-155A-RNZH-C5	078-155J-RNZH-C5	Not available
480V 50Hz	•077-155A-SEZH-C5	078-155J-SEZH-C5	Not available
110/130V 60Hz	•077-156A-PNZH-C6	078-156J-PNZH-C6	Not available
200/250V 60Hz	•077-156A-RNZH-C6	078-156J-RNZH-C6	Not available
480V 60Hz	•077-156A-SEZH-C6	078-156J-SEZH-C6	Not available
12/24/40/110V D.C.	077-151A-		



A.C. Phase Sequence and Phase Failure Indicator

A.C. Phase Sequence, Phase Failure Indicators

Product Codes – Neon Bulb Type. Burden 2.5VA

2 neon bulbs for phase sequence indication - first marked correct 1-2-3, second marked incorrect 3-2-1. 3 neon bulbs for phase failure indication - first marked 1, second marked 2, third marked 3.

Rating	4½" Square Flange		8¾" Square Flange
	Standard Case Catalogue No.	Sealed Case Hi-Shock Catalogue No.	Standard Case Catalogue No.
100/150V 50/60Hz	077-12PA-P2C6	Not available	Not available
151/300V 50/60Hz	077-12PA-P3C6	Not available	Not available
301/500V 50/60Hz	077-12PA-P4C6	Not available	Not available

For connection diagrams please see Fig. 1 page 58.

D.C. Indicators for Tachometer Generators

Product Code

Rating	4½" Square Flange		8¾" Square Flange
	Standard Case Catalogue No.	Sealed Case Hi-Shock Catalogue No.	Standard Case Catalogue No.
D.C. Volts	077-052A-***	078-052J-***	079-052A-***

Select nearest higher rated voltmeter and specify requirement

• UL recognised File # E87815

•• JT for type J, KT for type K thermocouple

* Other ranges available upon request - Consult Factory.

** RI for 10 ohm or R2 to 100ohm platinum.

*** Specify input and scale



A.C. Power Factor Meter

A.C. Power Factor Meter

Specification

Ratings, self-contained:	Current windings 5 amperes. Voltage windings minimum 50 volts, maximum 600 volts
Accuracy Class:	1.0
Overshoot:	33%
External Temperature Influence:	0.5% fid max.
External Field Influence:	3% fid max.
Frequency Range:	50Hz or 60Hz standard, 25-3000Hz optional (Specify)
Frequency Influence:	Single phase instruments, 59 to 61Hz 1.0% fid max. Polyphase instruments $\pm 10\%$ deviation from 69Hz: 1.0%
Overload capacity:	Current coils 1000% momentarily, 100% for 15 minutes and 25% indefinitely. Voltage circuits 25% indefinitely.
Burdens:	Each current circuit, 1.5VA approx Each voltage circuit 1VA approx Measuring systems 077-427 - 3 or 4 wire
Ranges available:	Lag 0.5-1 - 0.5 lead power factor Lag 0.2-1 - 0.8 lead power factor

JIS dimension product available on request. Instruments may be used on loads down to 20% of current rating and between 90% and 110% of voltage rating.

Product Codes – Balanced Load Accuracy $\pm 1\%$

Measured System		Scales	4½" Square Flange		8¾" Square Flange		
Phases	Wires		Standard Case Catalogue No.	Sealed Case Hi-Shock Catalogue No.	Standard Case Catalogue No.		
1	2	5	120V	0.5-1-0.5	+/-077-425A-QQAD	078-425J-QQAD	+079-425A-QQAD
1	2	5	240V	0.5-1-0.5	+/-077-425A-QSAD	078-427J-QSAD	+079-427A-QSAD
3	3/4	5	120V	0.5-1-0.5	+/-077-427A-QQAD	078-427J-QQAD	+079-427A-QAAD
3	3/4	5	208V	0.5-1-0.5	+/-077-427A-QRAD	078-427J-QRAD	+079-427A-QRAD
3	3/4	5	240V	0.5-1-0.5	+/-077-427A-QSAD	078-427J-QSAD	+079-427A-QSAD
3	3/4	5	480V	0.5-1-0.5	077-427A-QTAD	078-427J-QTAD	079-427A-QTAD

For connection diagrams please see Fig. 13 & 15 page 59.

Product Codes – Unbalanced Load Accuracy $\pm 1\%$

Measured System		Scales	4½" Square Flange		8¾" Square Flange		
Phases	Wires		Standard Case Catalogue No.	Sealed Case Hi-Shock Catalogue No.	Standard Case Catalogue No.		
3	3	5	120V	0.5-1-0.5	077-TFUA-QQAD	-	-
3	3	5	240V	0.5-1-0.5	077-TFUA-QSAD	-	-

For connection diagrams please see Fig. 12 page 59.

• UL Recognised File # E87815

+ CSA Approved File # LR52592



360° Power Factor Meter

360° Power Factor

Specification

Ratings, self-contained:	Current windings minimum, 0.5 amps, maximum 20 amps. Voltage windings min. 50 volts, maximum 240 volts, for higher voltages up to 480 volts an external box is supplied.			
Normal Operating Position:	On vertical panel unless otherwise specified at the time of order.			
Position Influence:	Not more than 1% of scale length for up to 60° tilt from normal operating position			
Accuracy Class:	1.0			
Overshoot:	33%			
External Temp. Influence:	0.5% fid. max.			
External Field Influence:	3% fid. max			
Frequency Influence:	Single phase instruments from 59 to 61Hz 1% max. fid. max. Polyphase instrument ±10% deviation from 60Hz: 1% fid. max.			
Overload Capacity:	Current coils 1000% momentarily, 100% for 15 minutes, and 50% indefinitely. Voltage circuits 50% indefinitely.			
Characteristics	077-132		077-136	
	A	V	A	V
Impedance ohms:	0.162	3380	0.043	3380
Resistance ohms:	0.147	3300	0.04	3300
Resistance ohms:	0.082	750	0.016	750
Watts:	3.5	1.39	1.0	1.30
Volt-Amperes:	4.05	1.42	1.07	1.42
Reactive VA:	2.03	0.281	0.4	0.281
Power Factor:	0.86	0.96	0.93	0.98

Product Codes – Rotary Power Factor - 360°

3 3/4 5 120V	0-1-0	077-136A-QQAB	078-136J-QQAB	079-136A-QQAB
3 3/4 5 208V	0-1-0	077-136A-QRAB	078-136J-QRAB	079-136A-QRAB
3 3 5 120V	0-1-0	077-132A-QQAB	078-132J-QSAB	079-132A-QSAB
3 3 5 208V	0-1-0	077-132A-QRAB	078-132J-QTAB	079-132A-QTAB

For connection diagrams please see Fig. 4, 6 & 7 page 58.

Rotating iron 360° products are only suitable for use on 50 and 60 Hz systems.

3 Phase 4 Wire Power Factor Meters are connected L-L ie. 120V L-N system will be rated at 208V L-L.	Model -136 unbalanced load, -132 balanced load • UL Recognised File # E87815 + CSA Approved File # LR52592
---	--



360° Rotary Synchroscope

360° Rotary Synchroscope

Specification

Rating, self-contained:	120V A.C.	
Frequency rating:	50 or 60Hz (specify), 400Hz optional	
Normal Operating Position:	On vertical panel unless otherwise specified at time of order	
Position Influence:	Not more than 3.6 mechanical degrees deviation for up to 60° tilt from normal operating position.	
Accuracy:	2 degrees	
Overshoot:	33% maximum	
Response time:	3 seconds maximum for 180° deflection	
Sensitivity at synchronism:	3 electrical degrees maximum	
External field influence:	3% maximum in 5 oersted field	
Pull in frequency:	58Hz	
Drop-out frequency:	57Hz	
Dielectric test:	Live parts to case, including panel: 2600V RMS for 1 minute.	
Between running and incoming circuits:	1500V RMS for 1 minute	
Overload capacity:	50% indefinitely	
Characteristics	Incoming circuit	Running circuit
Impedance ohms:	4670	5335
Resistance ohms:	4020	5240
Resistance ohms:	2380	1058
Reactive Volt amps:	1.57	0.535
Volt-amps:	3.08	2.7
Power factor:	0.86	0.98
Watts:	2.66	2.65

Product Codes – Pivot and Jewel

Rating	Scaling*	4½" Square Flange		8¾" Square Flange
		Standard Case Catalogue No.	Sealed Case Hi-Shock Catalogue No.	Standard Case Catalogue No.
120V 50Hz	SLOW FAST	•/+077-145A-PRAE-C5	078-145J-PRAE-C5	•079-145A-PRAE-C5
120V 60Hz	SLOW FAST	•/+077-146A-PRAE-C6	078-146J-PRAE-C6	•079-146A-PRAE-C6
120V 400Hz	SLOW FAST	077-144A-PRAE-C4	078-144J-PRAE-C4	079-144A-PRAE-C4

For connection diagrams please see Fig. 10 page 59.

Alternate voltage of 240V, use code RR instead of PR.

• UL Recognised File # E87815
+ CSA Approved File # LR52592



360° A.C. LED Synchronoscope

360° A.C. LED Synchronoscope

Specification

Voltage:	120, 240, 480 Volts A.C. or via P.T.
Frequency:	40/65Hz
Burden @ 60Hz:	4VA maximum Suitable for single or three phase systems
Safety:	IEC1010-1(300V A.C. rms installation degree 2)
Dielectric:	4kV rms for 1 minute
Isolation:	BUS/GEN/RELAY
Vibration:	To Lloyds shipping specification

Product Codes

Rating	Scaling	4½" Square Flange Standard Case Catalogue No.
120V 40/65Hz	SLOW FAST	077-14AU-PQYY-FQ
240V 40/65Hz	SLOW FAST	077-14AU-RRYY-FQ
480V 40/65Hz	SLOW FAST	077-14AU-SEYY-FQ

For connection diagrams please see Fig. 8 page 58.



A.C. Synchrocheck Relay & LED 360° Synchronoscope

A.C. Synchrocheck Relay and LED 360° Synchronoscope

Specification

Voltage:	110/120V (115V nominal) 220/240V (230V nominal) 380/480V (430V nominal)
Phase Difference:	+0 to 20° ±1°
Voltage Difference:	+0 to 20% ±2%
Time Delay:	0 to 2.5 seconds +10%

Product Codes

Rating	Scaling	4½" Square Flange Standard Case Catalogue No.
Live Bus		
110/120V 40/65Hz	SLOW FAST	077-14GU-POYY-FQ
220/240V 40/65Hz	SLOW FAST	077-14GU-RSYY-FQ
380/480V 40/65Hz	SLOW FAST	077-14GU-SZYY-FQ
Dead Bus		
110/120V 40/65Hz	SLOW FAST	077-14HU-POYY-FQ
220/240V 40/65Hz	SLOW FAST	077-14HU-RSYY-FQ
380/480V 40/65Hz	SLOW FAST	077-14HU-SZYY-FQ
Live Bus		
120V 40/65Hz	SLOW FAST	077-14LU-PQYY-FQ
240V 40/65Hz	SLOW FAST	077-14LU-RRYY-FQ
480V 40/65Hz	SLOW FAST	077-14LU-SEYY-FQ
Dead Bus		
120V 40/65Hz	SLOW FAST	077-14DU-PQYY-FQ
240V 40/65Hz	SLOW FAST	077-14DU-RRYY-FQ
480V 40/65Hz	SLOW FAST	077-14DU-SEYY-FQ

For connection diagrams please see Fig. 9 page 58.

In the 0.77-14G and 0.77-14H models, the generator voltage is free to track the bus voltage (+ the voltage difference preset) over the input voltage range. In the 077-14L and 077-14D models, the generator voltage is to match the nominal input (bus) voltage specified (within the voltage difference preset).



D.C. Transducer Indicator

D.C. Transducer Indicators

Product Codes

Rating	Scaling*	4½" Square Flange		8¾" Square Flange
		Standard Case Catalogue No.	Sealed Case Hi-Shock Catalogue No.	Standard Case Catalogue No.
WATTS 1mA	TO SUIT	•/+077-055A-FA**	078-055J-FA**	•079-055A-FA**
VARS 1mA	TO SUIT	•/+077-056A-FA**	078-056J-FA**	•079-056A-FA**
FREQUENCY 1mA	TO SUIT	•/+077-053A-FA**	078-053J-FA**	•079-053A-FA**
POWER FACTOR 1mA	TO SUIT	•/+077-054A-FA**	078-054J-FA**	•079-054A-FA**
A.C. AMPS 1mA	TO SUIT	•/+077-05AA-FA**	078-05AJ-FA**	•079-05AA-FA**
A.C. VOLTS 1mA	TO SUIT	•/+077-05VA-LT**	078-05VJ-LT**	•079-05VA-LT**
SPEED 1mA	TO SUIT	•/+077-052A-FA**	078-052J-FA**	•079-052A-FA**
VA 1mA	TO SUIT	•/+077-057A-FA**	078-057J-FA**	•079-057A-FA**

For use with the following transducers:-
Watts, VARs, Frequency, Power Factor,
A.C. Amperes, A.C. Volts & Temperature

* Case types 077/078/079 use 10-32 UNF terminals. For M5 screw clamp terminals stipulate case type 075
** Specify scale. Input: 1mA D.C. for 4/20mA change "FA" to "HG"



A.C. Watt/Watt Hour Meter

A.C. Watt & Watt Hour Meters

Moving coil indication gives instantaneous reading of Watts. Self Contained circuitry drives an impulse counter to give Watt hour indication.

Product Codes – Transducer Driven Accuracy ±1%.

With internal linear integrator and six digit impulse counter. Externally powered.

Rating	Scaling	4½" Square Flange		8¾" Square Flange
		Standard Case Catalogue No.	Sealed Case Hi-Shock Catalogue No.	Standard Case Catalogue No.
120V, 240V 1mA	TO SUIT	077-KHAU-FA**	078-KHAJ-FA**	Not available
50/60Hz 4-20mA		077-KHAU-HG**	078-KHAJ-HG**	

For connection diagrams please see Fig. 19 page 59.

Product Codes – Self Contained - Accuracy instantaneous 1%.

Kilowatt hour 0.5% of pulse rate/hour.

Single element. Transformer rated 50/60Hz. Hi-Q Taut Band. Integral transducer.

Measured System	Scales	4½" Square Flange		8¾" Square Flange
		Standard Case Catalogue No.	Sealed Case Hi-Shock Catalogue No.	Standard Case Catalogue No.
Phases Wires Amperes 2VA max. Burden Volts 1VA max. Burden				
1 2 5 120	TO SUIT	077-KHBU-QQ**	078-KHBJ-QQ**	Not available

For connection diagrams please see Fig. 21 page 60.

2 element. Transformer rated. 50/60Hz. Hi-Q Taut Band. Integral transducer.

3 3 5 120	TO SUIT	077-KHEU-QQ**	078-KHEJ-QQ**	Not available
3 3 5 208	TO SUIT	077-KHEU-QR**	078-KHEJ-QR**	Not available

For connection diagrams please see Fig. 25 page 60.

2½ Element. Transformer rated. 50/60Hz. Hi-Q Taut Band. Integral transducer.

3 4 5 69	TO SUIT	077-KHGU-QL**	078-KHGJ-QL**	Not available
3 4 5 120	TO SUIT	077-KHGU-QQ**	078-KHGJ-QQ**	Not available
3 4 5 277	TO SUIT	077-KHGU-QY**	078-KHGJ-QY**	Not available

For connection diagrams please see Fig. 28 page 60.

** Specify pulse rate and external power supply
+ CSA Approved File # LR52592

• UL Recognised File # E87815

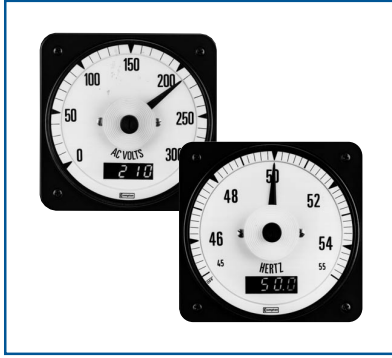

Features

- Rugged shock and vibration taut band design
- High accuracy LED display
- Wide selection of AC and DC inputs
- Maximum trend indication visibility
- Input isolation
- External decimal point selection option
- Interchangeable with 4 1/2" switchboard meters

Benefits

- Cost effective
- Meets all the requirements of ANSI-C39.1 (1981)
- IP54 (NEMA 3) protection.
- Optional IP55 (NEMA 4) gasket
- Bump, shock and vibration proof
- Customised options and features

Applications

- Switchgear
- Distribution systems
- Generator sets
- Control panels
- Energy management
- Building management
- Utility power monitoring
- Process control
- Motor control

Approvals

UL recognised File No: E140758

LED Digital / Analogue Combination

The Crompton model 077-DI features a combination of the traditional 250° 4 1/2" switchboard indicator with the benefits of wide angle visibility plus trend indication. This rugged shock and vibration resistant taut band design provides precision accuracy and instantaneous reading via the bright in dial mounted 3 1/2 digit LED display.

Description

Model 077-DI digital analogue indicators are ideal for all applications where moving pointer instruments are preferable to indicate trend while simultaneously displaying a high visibility precision LED readout for increased user interface.

Packaged in a weather resistant case, the 077-DI is interchangeable with other analogue and digital instruments designed to directly mount in to a standard ANSI-C39. 4 1/2" switchboard cut-out.

Available in side, center, or off-set zero versions the 077-DI can accept A.C. Current, Voltage, Frequency, Watts, VArS and Phase Angle or D.C.Current and Voltage direct inputs as well as a wide range of transducer outputs making it suitable for a variety of other applications including low-load current, temperature, speed, watt/vars,percent and level.

Specification

Inputs:	D.C. Voltage: 20mV-600V (1MΩ input impedance as standard) D.C. Current: 1mA-1A, 4 to 20mA (Voltage drop 200mV nominal). External shunt operation (50mV and 100mV). A.C. Voltage: 200mV-600V (1 kΩ / volt) A.C. Current: 1mA-999mA (Using internal shunt, voltage drop 200mV nominal). 1A, 2A, 5A & 10A using internal current transformer.
Common mode rejection:	=>80dB @ 50/60Hz
Overload:	Voltage: x 1.2 continuous. x1.5 for 10 seconds. Current using internal CT: x 1.2 continuous. x 10 for 10 seconds.
External Power Requirement:	Standard: 120 & 240V ±15%. Optional: 480V ±15% A.C. 40 to 60Hz
Burden:	3VA @ 60Hz
D.C.:	Standard: 12, 24, 48,110 & 125V ±15%
Display Analogue:	Long scale moving coil. 250° deflection. Scale length 6.8inches. Response time less than 2.5 seconds.
Display Options:	Center or offset zero. Scale plate in colors other than white. Colored lines or segments on scale. Slower response time.
Digital Display:	3 1/2 digit red LED. 7 segment (7.6mm, 0.3" high). Right hand decimal points. Polarity indication: positive / none. Negative / horizontal bar " - ". Update time (standard): 1 per second
Accuracy – Analogue:	D.C & A.C: ±1% of FSD (calibrated at 25°C)
Accuracy – Digital:	DC: ±0.05% of reading ±1 count ±100ppm of reading / °C. (Maximum). A.C. current: 0-1 Amp ±0.1% reading ±3 counts ±150ppm of reading / °C. A.C. current: 0-10 amps ±0.1% reading ±10 counts ±150ppm of reading / °C (maximum) A.C. Voltage: ±0.1% of reading ±3 counts ±150ppm of reading / °C. (maximum) Zero ±1 count ±0.2 counts/°C (maximum) D.C. offset scale only Warm up time: 1 minute
Long Term Stability:	±2 counts
Calibration Check:	Recommended 12 monthly intervals
Enclosure Code:	IP54 (Optional IP55 using panel gasket)
Operational Temperature:	0 to +60°C (32° to 140°F).
Storage Temperature:	-20 to +60°C (-4° to 140°F)
Humidity:	Up to 90% relative @ 55°C. Tests to BS2011 part 2DA.
Isolation Test Voltage:	2kV RMS 60Hz for 1 minute
Interference Rejection:	To IEEE STD472, ANSI C37 90A, SEN 361503, IEC 255-4
Approvals:	EMC and LVD UL recognised file E140758



A.C. Voltmeter

LED Digital/Analogue Combination

Product Codes – A.C. Voltmeters - direct reading (40/2000Hz)***

Digital accuracy $\pm 0.1\%$ ± 3 counts analogue accuracy $\pm 1\%$.

Rating	Scaling*	Catalogue No.
200mV	0-200mV	077-DIWA-KAKA-C6-**
250mV	0-250mV	077-DIWA-KDKD-C6-**
500mV	0-500mV	077-DIWA-KMKM-C6-**
1V	0-1V	077-DIWA-LALA-C6-**
5V	0-5V	077-DIWA-LSLS-C6-**
10V	0-10V	077-DIWA-MTMT-C6-**
15V	0-15V	077-DIWA-NDND-C6-**
30V	0-30V	077-DIWA-NLNL-C6-**
150V	0-150V	077-DIWA-PZPZ-C6-**
250V	0-250V	077-DIWA-RSRS-C6-**
300V	0-300V	077-DIWA-RXRJ-C6-**
500V	0-500V	077-DIWA-SFSF-C6-**
600V	0-600V	077-DIWA-SJSJ-C6-**

For connection diagrams please see Fig. 45 page 62.

Product Codes – A.C. Voltmeters Transformer Rated (40/2000Hz)***

Rating	Scaling*	Catalogue No.
150V	0-300V	077-DIWA-PZRX-C6-**
150V	0-600V	077-DIWA-PZSJ-C6-**
150V	0-750V	077-DIWA-PZSM-C6-**
150V	0-3000V	077-DIWA-PZUA-C6-**
143V	0-5000V	077-DIWA-PTUJ-C6-**
150V	0-5250V	077-DIWA-PZUL-C6-**
150V	0-6000V	077-DIWA-PZUP-C6-**
150V	0-9000V	077-DIWA-PZUY-C6-**
150V	0-15KV	077-DIWA-PZWC-C6-**
150V	0-18KV	077-DIWA-PZWD-C6-**
150V	0-45KV	077-DIWA-PZWJ-C6-**
150V	0-60KV	077-DIWA-PZWL-C6-**

For connection diagrams please see Fig. 45 page 62.



A.C. Ammeter

Product Codes – A.C. Ammeters - direct reading (40/2000Hz)***

Rating	Scaling*	Catalogue No.
1A	0-1A	077-DIBA-LALA-C6-**
1.5A	0-1.5A	077-DIBA-LCLC-C6-**
2A	0-2A	077-DIBA-LELE-C6-**
3A	0-3A	077-DIBA-LJLJ-C6-**
5A	0-5A	077-DIBA-LSLS-C6-**
8A	0-8A	077-DIBA-MJMJ-C6-**
10A	0-10A	077-DIBA-MTMT-C6-**

For connection diagrams please see Fig. 45 page 62.

Product Codes – Power Supply

MU - 12 Volts D.C.	PQ - 120 Volts A.C.
Z2 - 130 Volts D.C.	PR - 120 Volts D.C.
BD - 24 Volts D.C.	RR - 240 Volts A.C.
PO - 115 Volts A.C.	PS - 125 Volts D.C.
NR - 48 Volts D.C.	

* Other scalings available.

** Specify power supply voltage, for the code, see Power Supply Codes table.

*** Case types 077/078/079 use 10-32 UNF terminals.

For M5 screw clamp terminals stipulate case type 075



A.C. Ammeter

LED Digital/Analogue Combination

Product Codes – A.C. Ammeters Transformer Rated (40/2000Hz)

Digital accuracy $\pm 0.1\%$ ± 1 counts analogue accuracy $\pm 1\%$.

Rating	Scaling*	Catalogue No.
5A	0-10A	077-DIBA-LSMT-C6-**
5A	0-15A	077-DIBA-LSND-C6-**
5A	0-20A	077-DIBA-LSNG-C6-**
5A	0-25A	077-DIBA-LSNJ-C6-**
5A	0-30A	077-DIBA-LSNL-C6-**
5A	0-40A	077-DIBA-LSNP-C6-**
5A	0-50A	077-DIBA-LSNT-C6-**
5A	0-60A	077-DIBA-LSNW-C6-**
5A	0-75A	077-DIBA-LSPB-C6-**
5A	0-80A	077-DIBA-LSPD-C6-**
5A	0-100A	077-DIBA-LSPK-C6-**
5A	0-150A	077-DIBA-LSPZ-C6-**
5A	0-200A	077-DIBA-LSRL-C6-**
5A	0-250A	077-DIBA-LSRS-C6-**
5A	0-300A	077-DIBA-LSRX-C6-**
5A	0-400A	077-DIBA-LSSC-C6-**
5A	0-500A	077-DIBA-LSSF-C6-**
5A	0-600A	077-DIBA-LSSJ-C6-**
5A	0-750A	077-DIBA-LSSM-C6-**
5A	0-800A	077-DIBA-LSSN-C6-**
5A	0-1000A	077-DIBA-LSSS-C6-**
5A	0-1200A	077-DIBA-LSSU-C6-**
5A	0-1500A	077-DIBA-LSTC-C6-**
5A	0-1600A	077-DIBA-LSTE-C6-**

For connection diagrams please see Fig. 45 page 62.



A.C. Frequency Meter

Product Codes – A.C. Frequency Meters

Self contained 110/130+ Volts rating. Moving Coil Indicator Integral transducer

Centre Frequency	Accuracy	Scaling*	Catalogue No.
50Hz	± 0.15	45-55Hz	077-DZLA-PNAG-AG
50Hz	± 0.15	46-54Hz	077-DZLA-PNAH-AH
55Hz	± 0.25	45-65Hz	077-DZLA-PNAJ-AJ
60Hz	± 0.25	50-70Hz	077-DZLA-PNAL-AL
60Hz	± 0.15	55-65Hz	077-DZLA-PNAN-AN
60Hz	± 0.15	56-64Hz	077-DZLA-PNAO-AO
60Hz	± 0.08	58-62Hz	077-DZLA-PNAT-AT
400Hz	± 1.3	350-450Hz	077-DZLA-PNBH-BH
400Hz	± 1.25	360-440Hz	077-DZLA-PNBI-BI
400Hz	± 0.08	380-420Hz	077-DZLA-PNBK-BK

For connection diagrams please see Fig. 44 page 62.

Product Codes – Power Supply

MU - 12 Volts D.C.	PQ - 120 Volts A.C.
Z2 - 130 Volts D.C.	PR - 120 Volts D.C.
BD - 24 Volts D.C.	RR - 240 Volts A.C.
PO - 115 Volts A.C.	PS - 125 Volts D.C.
NR - 48 Volts D.C.	

- Alternative voltage rating 200/250V specify RN instead of PN
- Alternative voltage rating 380/480V specify SE instead of PN
- * Other scales are available.
- ** Specify power supply voltage, for the code, see Power Supply Codes table.



D.C. Voltmeter



Transducer Indicator

LED Digital/Analogue Combination

Product Codes – D.C. Voltmeters - Direct Reading

Digital accuracy $\pm 0.5\%$ ± 1 counts analogue accuracy $\pm 1\%$.

Rating	Scaling*	Catalogue No.
200mV	0-200mV	077-DIVA-KAKA-**
250mV	0-250mV	077-DIVA-KDKD-**
500mV	0-500mV	077-DIVA-KMKM-**
1V	0-1V	077-DIVA-LALA-**
5V	0-5V	077-DIVA-LSLS-**
10V	0-10V	077-DIVA-MTMT-**
15V	0-15V	077-DIVA-NDND-**
30V	0-30V	077-DIVA-NLNL-**
50V	0-50V	077-DIVA-NTNT-**
75V	0-75V	077-DIVA-PBPB-**
80V	0-80V	077-DIVA-PDPD-**
150V	0-150V	077-DIVA-PZPZ-**
300V	0-300V	077-DIVA-RXR X-**
400V	0-400V	077-DIVA-SCSC-**
500V	0-500V	077-DIVA-SFSF-**
600V	0-600V	077-DIVA-SJSJ-**
150-0-150V	150-0-150V	077-DINA-RXR X-**
300-0-300V	300-0-300V	077-DINA-SJSJ-**
600-0-600V	600-0-600V	077-DINA-SUSU-**

For connection diagrams please see Fig. 45 page 62.

Product Codes – Transducer Indicators***

For use with the following transducers:	Catalogue No.
Watts, VAr s, Frequency, Power Factor, A.C. Amperes A.C. Volts, Temperature	077-DITA-****-**

For connection diagrams please see Fig. 45 page 62.

Product Codes – Indicators for Tachometer Generators

Rating	Scaling*	Catalogue No.
A.C. or D.C.	FPM or RPM	077-DI2A-****-**

For connection diagrams please see Fig. 45 page 62.

Product Codes – Power Supply

MU - 12 Volts D.C.	PQ - 120 Volts A.C.
Z2 - 130 Volts D.C.	PR - 120 Volts D.C.
BD - 24 Volts D.C.	RR - 240 Volts A.C.
PO - 115 Volts A.C.	PS - 125 Volts D.C.
NR - 48 Volts D.C.	

- * Other scales are available.
- ** Specify power supply voltage, for the code, see Power Supply Codes table.
- *** Case types 077/078/079 use 10-32 UNF terminals.
For M5 screw clamp terminals stipulate case type 075
- **** Specify input and scaling



D.C. Ammeter

LED Digital/Analogue Combination

Product Codes – D.C. Ammeters - Shunt Rated

Digital accuracy $\pm 0.5\%$ ± 1 counts analogue accuracy $\pm 1\%$.

Rating	Scaling*	Catalogue No.
50mV-4mA	Scaled to suit	077-DIAA-EY
50-0-50mV-2-0-2mA		077-DICA-GB
100-0-100mV	standard	077-DICA-GM
100-0-100mV-2-0-2mA	shunt ratings	077-DICA-FM

For connection diagrams please see Fig. 45 page 62.

Product Codes – D.C. Ammeters - Suppressed Zero

Digital accuracy $\pm 0.5\%$ ± 1 counts analogue accuracy $\pm 1\%$

Rating	Scaling*	Catalogue No.
1-5mA	To suit requirements	077-DIAA-GM
4-20mA		077-DIAA-HG
10-50mA		077-DIAA-HZ

For connection diagrams please see Fig. 45 page 62.

Product Codes – D.C. Ammeters – Direct Reading

Digital accuracy $\pm 0.5\%$ ± 1 counts analogue accuracy $\pm 1\%$.

Rating	Scaling*	Catalogue No.
1mA	0-1mA	077-DIAA-FAFA-**
2mA	0-2mA	077-DIAA-FGFG-**
5mA	0-5mA	077-DIAA-FXFX-**
10mA	0-10mA	077-DIAA-GZGZ-**
20mA	0-20mA	077-DIAA-HFHF-**
30mA	0-30mA	077-DIAA-HMHM-**
50mA	0-50mA	077-DIAA-HYHY-**
100mA	0-100mA	077-DIAA-JRJR-**
200mA	0-200mA	077-DIAA-KAKA-**
300mA	0-300mA	077-DIAA-KGKG-**
500mA	0-500mA	077-DIAA-KMKM-**
800mA	0-800mA	077-DIAA-KWKW-**
1A	0-1A	077-DIAA-LALA-**

For connection diagrams please see Fig. 45 page 62.

Product Codes – Power Supply

MU - 12 Volts D.C.	PQ - 120 Volts A.C.
Z2 - 130 Volts D.C.	PR - 120 Volts D.C.
BD - 24 Volts D.C.	RR - 240 Volts A.C.
PO - 115 Volts A.C.	PS - 125 Volts D.C.
NR - 48 Volts D.C.	

* Other scales are available.

** Specify power supply voltage, for the code, see Power Supply Codes table.



A.C. Wattmeter

LED Digital/Analogue Combination

Product Codes – A.C. Wattmeters. Accuracy $\pm 1\%$. Single Phase 50/60Hz

Measured System		Scales	4½" Square Flange Standard Case Catalogue No.	
Phases	Wires			
Amperes	1 VA max. Burden			
Volts	1 VA max. Burden			
1	2	5A 120V	TO SUIT	077-DW5A-QQ**-C6
1	2	5A 240V	TO SUIT	077-DW5A-QS**-C6

For connection diagrams please see Fig. 37 page 61.

Product Codes – A.C. Wattmeters. 2 Element, Transformer Rated. 50/60Hz. Integral Transducer. Accuracy 1.0%

3	3	5A 120V	TO SUIT	077-DW8A-QQ**-C6
3	3	5A 208V	TO SUIT	077-DW8A-QR**-C6

For connection diagrams please see Fig. 38 page 62.

Product Codes – A.C. Wattmeters. 3 Element, Transformer Rated. 50/60Hz. Integral Transducer.

3	4	5A 69V	TO SUIT	077-DW9A-QL**-C6
3	4	5A 120V	TO SUIT	077-DW9A-QQ**-C6

For connection diagrams please see Fig. 39 page 62.

Product Codes – A.C. Varmeters. 2 Element Transformer Rated 50/60Hz. Integral Transducer.

3	3	5A 120V	TO SUIT	077-DXLA-QQ**-C6
3	3	5A 208V	TO SUIT	077-DXLA-QR**-C6

For connection diagrams please see Fig. 40 page 62.

Product Codes – A.C. Varmeters. 2½ Element, Transformer Rated. 50/60Hz. Hi-Q Taut Band. Integral Transducer. Accuracy 1.0%.

3	4	5A 120V	TO SUIT	077-DXUA-QQ**-C6
3	4	5A 208V	TO SUIT	077-DXUA-QR**-C6

For connection diagrams please see Fig. 41 page 62.



A.C. Varmeter

Product Codes – Power Factor & Phase Angle Meters. Accuracy 1.0% (Balanced Loads). Self Contained. 60Hz. Integral Transducer.

1	2	5A 120V	0.5-1-0.5 LAG/LEAD & 60/0/60 DEG	077-DP5A-QQAD-C6
1	2	5A 240V	0.5-1-0.5 LAG/LEAD & 60/0/60 DEG	077-DP5A-QSAD-C6
3	3/4	5A 120V	0.5-1-0.5 LAG/LEAD & 60/0/60 DEG	077-DP7A-QQAD-C6
3	3/4	5A 208V	0.5-1-0.5 LAG/LEAD & 60/0/60 DEG	077-DP7A-QRAD-C6
3	3/4	5A 240V	0.5-1-0.5 LAG/LEAD & 60/0/60 DEG	077-DP7A-QSAD-C6
3	3/4	5A 480V	0.5-1-0.5 LAG/LEAD & 60/0/60 DEG	077-DP7A-QTAD-C6

For connection diagrams please see Fig. 42 & 43 page 62.

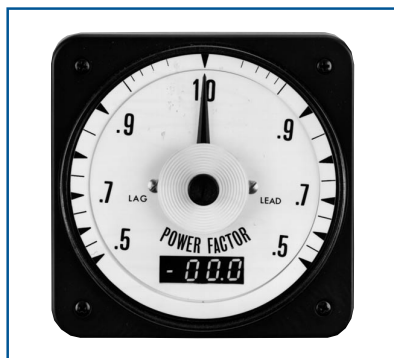

Power Factor/Phase Angle Meter

** Specify C.T. (Current Transformer) and V.T. (Voltage Transformer) ratios if used, and preferred scale at time of ordering.



LED Digital/Analogue Combination

Scale – Options

Options	Option Code
1. Blank, uncalibrated dial (zero and full scale marks in pencil).	SA
2. Red or coloured line or mark (specify position).	SR
3. Coloured zones or segments (specify limits and color(s)).	SZ
4. Non-standard caption (other than listed below).	SD
5. Black dial with white figures and pointer.	SB
6. Customer/user logo imprinted on dial.	SM
7. Finely divided scale.	-
8. Standard rating, single unlisted scale	-

Calibration – Options

Options	Option Code
10. Zero-center scale. Not available for A.C. ammeters & voltmeters	-
11. Offset-zero scale wattmeters, varmeters, DC ammeters & voltmeters.	-
12. Calibration to customer specification including special caption.	-
13. Calibration at other than vertical, specify required angle from vertical.	CM
14. Non-listed ratings.	-
15. Temperature calibration, other than 23°C ambient.	CT
16. a) Calibration at 400Hz. b) Calibration to other specific frequencies between 25 and 500Hz.	C4
17. Potentiometer, externally mounted $\pm 10\%$ range adjustment.	
18. Suppressed zero other than listed. D.C. only.	RA
19. Heavily damped movement.	PD

Construction – Options

Options	Option Code
20. Anti-glare window.	BR
21. Internal illumination Specify 6, 12, 24 or 36V D.C.	EL
22. Neoprene panel gasket.	MG
23. Red manual set pointer.	ER
25. Coloured bezel.	FA
26. Hermetically sealed case.	

Connection Diagrams

Fig. 1 Model 077-12P
Phase Sequence Indicator 3 phase 3 or 4 wire systems.

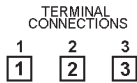

Fig. 2 Model 077-137
360° Dynamometer Power Factor Indicator Single Phase.

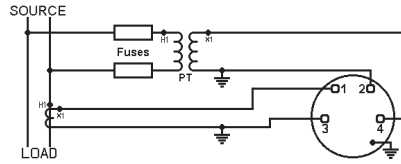

Fig. 3 Model 077-131
360° deg Dynamometer Power Factor Indicator 3 Phase 3 or 4 Wire Balanced Load (3 Currents 1 Voltage).

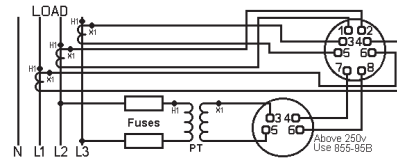

Fig. 4 Models 077-132, 078-132J
360° Dynamometer Power Factor Indicator 3 Phase 3 or 4 Wire Balanced Load (1 Current 3 Voltages).

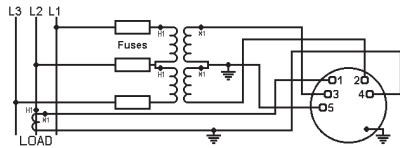

Fig. 5 Model 078-132B
360° Dynamometer Power factor Indicator 3 Phase 3 or 4 Wire Balanced Load (1 Current 3 Voltages).

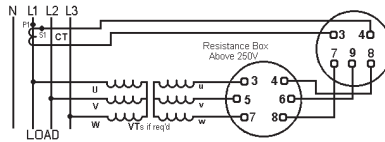

Fig. 6 Models 077-136, 077-136A, 078-136J
360° Dynamometer Power factor Indicator 3 Phase 3 or 4 Wire Unbalanced Load.



Fig. 7 Model 078-136B
360° Dynamometer Power factor Indicator 3 Phase 3 or 4 Wire Unbalanced Load.

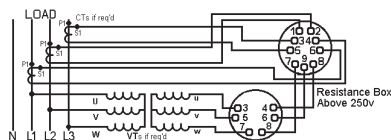

Fig. 8 Models 077-14A
360° LED Synchroscope.

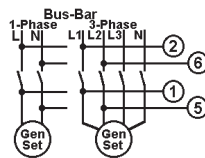
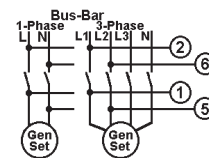

Fig. 9 Models 077-14D, 077-14G, 077-14H, 077-14L
360° LED Synchroscope and Synchro Check relay.

Phase sequence and polarity are important



Connection Diagrams

Fig. 10 Models 077-144, 077-145
077-146, 077-147, 078-144J, 078-145J
078-146J, 078-147J, 079-144, 079-145
079-146
360 Degree Dynamometer Synchroscope.

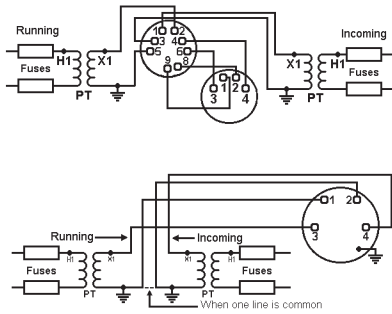

Fig. 11 Models 078-144B, 078-145B
078-146B, 078-147B
360 Degree Dynamometer Synchroscope.

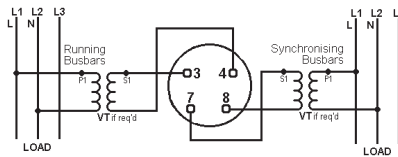

Fig. 12 Model 077-TFU
Power Factor Meter 3 Phase 3 Wire
Unbalanced Load.

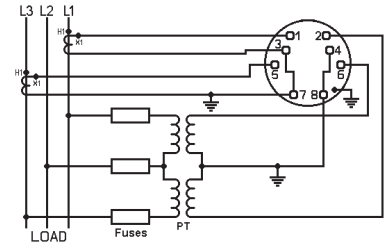

Fig. 13 Models 077-425, 078-425J
079-425
Electronic Phase Angle Meter Single
Phase.

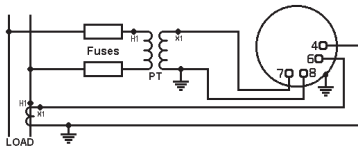

Fig. 14 Model 078-425B
Electronic Phase Angle Meter Single
Phase.

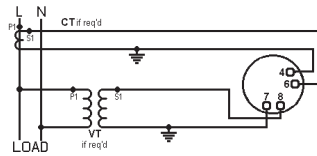

Fig. 15 Models 075-427, 077-427
078-427J, 079-427
Electronic Phase Angle Meter 3 phase 3
or 4 wire Balanced Load.

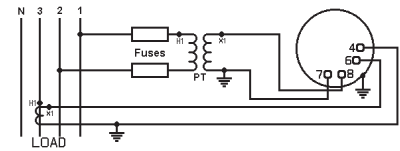

Fig. 16 Model 078-427B
Electronic Phase Angle Meter 3 phase 3
or 4 wire Balanced Load.

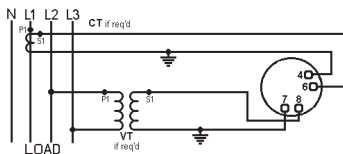
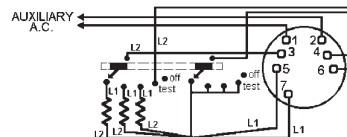

Fig. 17 Models 077-45R, 078-45R
Temperature Indicator for Resistance
Temperature Detector (RTD).



NOTE
All L1 Leads must be within 0.02 ohms of the same resistance
L1 Leads should not exceed 3 ohms each
L2 Leads should not exceed 0.02 ohms each

Fig. 18 Model 077-45T
Temperature Indicator for Thermocouple
Detector.

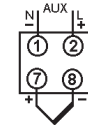
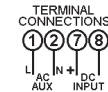

Fig. 19 Models 077-KHA, 078-KHA
AC Kilowatts/Kilowatthours (Transducer)
Indicator.



Connection Diagrams

Fig. 20 Model 077-45P
Tap Position Indicator.

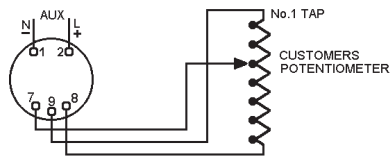

Fig. 21 Models 077-215, 077-KHB
078-215J, 078-KHBJ, 079-215
Wattmeter Single Phase.

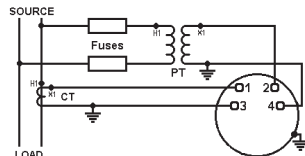

Fig. 22 Model 078-215B, 078-KHBB
Wattmeter Single Phase.

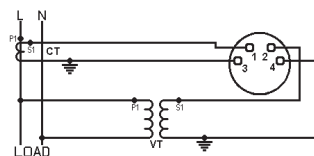

Fig. 23 Models 077-216, 078-216J
Wattmeter 3 Phase 3 Wire Balanced
Load.

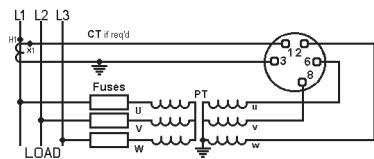

Fig. 24 Model 078-216B
Wattmeter 3 Phase 3 Wire Balanced
Load.

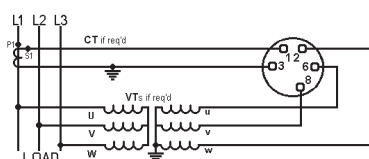

Fig. 25 Models 077-218, 077-KHE
078-218J, 078-KHEJ, 079-218
Wattmeter 3 Phase 3 Wire Unbalanced
Load.

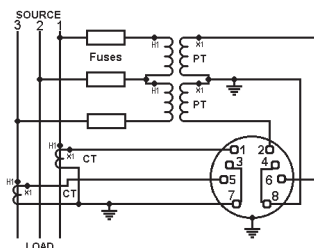

Fig. 26 Models 078-218B, 078-KHEB
Wattmeter 3 Phase 3 Wire Unbalanced
Load.

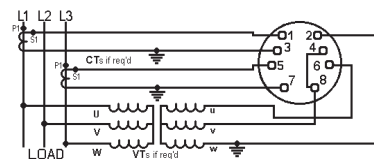

Fig. 27 Model 077-21D
Wattmeter 3 Phase 4 Wire Balanced
Load.

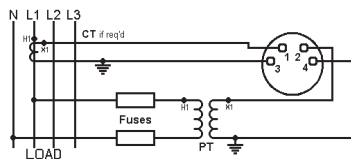
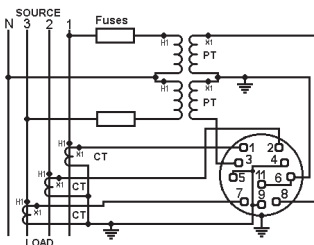

Fig. 28 Models 077-219, 077-KHG
078-219J, 078-KHGJ, 079-219
Wattmeter 3 Phase 4 Wire Unbalanced
Load.



Connection Diagrams

Fig. 29 Models 078-219B, 078-KHGB
Wattmeter 3 Phase 4 Wire Unbalanced Load.

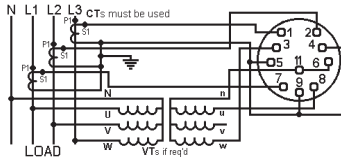

Fig. 30 Models 077-21B
Wattmeter 3 Phase 3 Wire Balanced Load 2 Reverse Connected CTs.

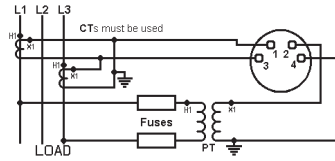

Fig. 31 Model 077-21F
Wattmeter 3 Phase 4 Wire Unbalanced Load Delta Connected CTs.

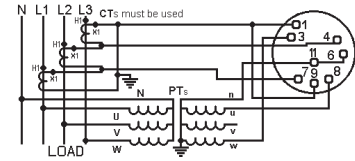

Fig. 32 Models 077-31L, 078-31LJ
Varmeter 3 Phase 3 Wire Unbalanced Load.

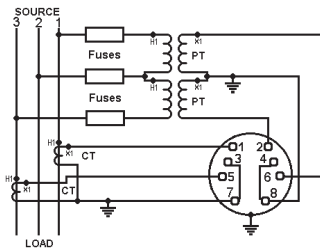

Fig. 33 Models 077-315
Varmeter 3 Phase 3 or 4 Wire Balanced Load.

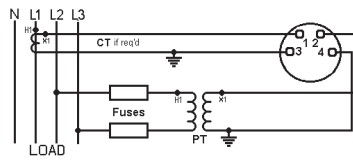

Fig. 34 Model 077-319
Varmeter 3 Phase 4 Wire Unbalanced Load.

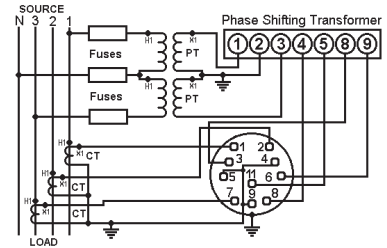

Fig. 35 Models 077-31U, 077-KXG
078-31U, 079-31U
Varmeter 3 Phase 4 Wire Unbalanced Load.

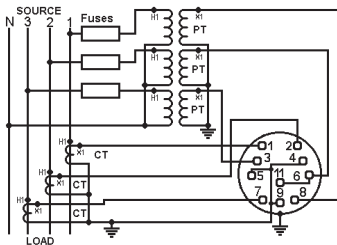
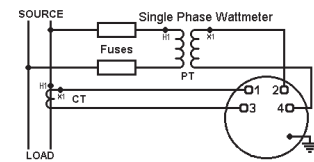

Fig. 36 Model 077-31F
Varmeter 3 Phase 4 Wire Unbalanced Load Delta Connected CTs.



Fig. 37 Model 077-DW5
LED Digital/Analogue Wattmeter Single Phase.



Connection Diagrams

Fig. 38 Model 077-DW8
LED Digital/Analogue Wattmeter 3 Phase
3 Wire Unbalanced Load.

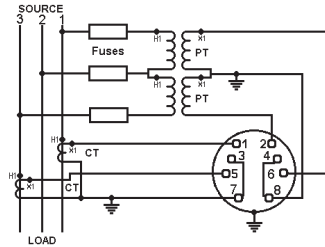

Fig. 39 Model 077-DW9
LED Digital/Analogue Wattmeter 3 Phase
4 Wire Unbalanced Load.

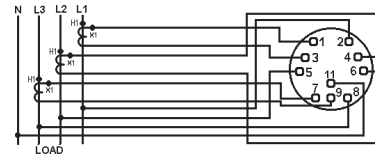

Fig. 40 Model 077-DXL
LED Digital/Analogue Varmeter 3 Phase
3 Wire Unbalanced Load.

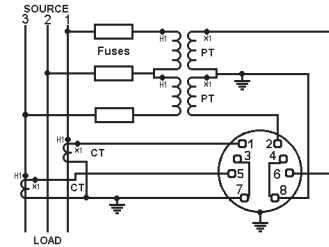

Fig. 41 Model 077-DXU
LED Digital/Analogue Varmeter 3 Phase
4 Wire Unbalanced Load.

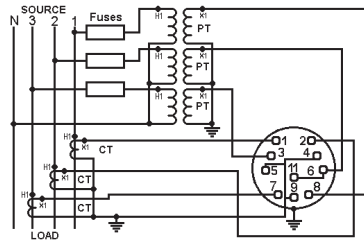

Fig. 42 Model 077-DP5
LED Digital/Analogue Phase Angle Meter
Single Phase.

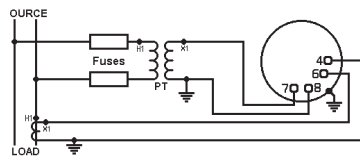

Fig. 43 Model 077-DP7
LED Digital/Analogue Phase Angle Meter
3 Phase 3 or 4 Wire Balanced Load.

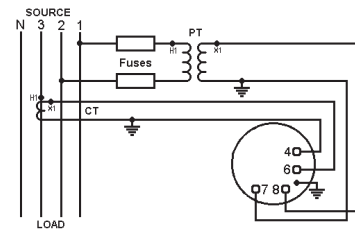

Fig. 44 Model 077-DZL
LED Digital/Analogue Frequency Meter.

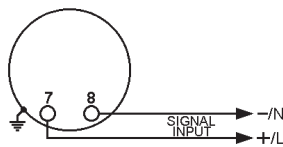

Fig. 45 Models 077-DI2, 077-DIA
077-DIB, 077-DIC, 077-DIN, 077-DIT
077-DIV, 077-DIW
LED Digital/Analogue Meter.

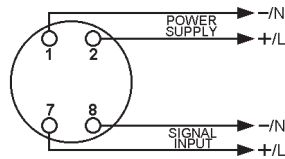

Fig. 46 Models 077-DA2, 077-DAA
077-DAB, 077-DAK, 077-DAT
077-DAV, 077-DAW
LCD Digital/Analogue Meter.

