

# OEM33 3.5 digit LCD digital voltmeter

## features

- 3.5 Digit 10mm character height LCD
- 200mV Full Scale sensitivity
- Automatic zeroing and polarity indication
- 11 selectable annunciators
- Easy to use decimal point selection
- Built in snap fastener
- Display hold feature standard

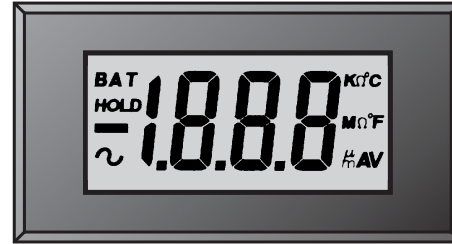

### DESCRIPTION

The OEM33 is one of the world's smallest digital voltmeters. It is an ideal replacement for analogue meters with advantages of accuracy, size and easy mounting. The module includes an A/D converter, LCD display of 10mm character height, and plastic housing with standard dual in line pin terminals for easy insertion into sockets or PC Board.

### DIMENSIONS

mm

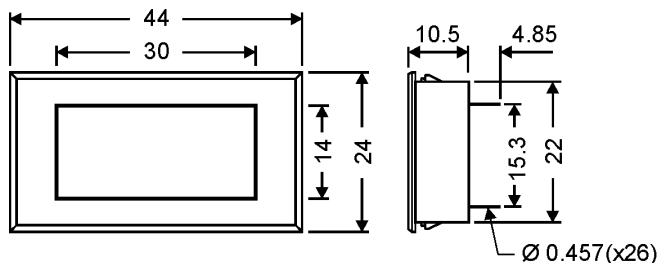

Panel cut out 40.5 x 22.5

Fastening clips accept panel thickness 0.9 to 3.2mm

### OPERATING SPECIFICATION

Operating temperature	0 to 50°C
Storage temperature	-20 to 70°C
Operating relative humidity	80%

### DISPLAY HOLD FACILITY

The OEM33 has a built in digital display hold facility. For normal, continuous operation connect the 'Hold 1' pin to the GD pin. To hold the present reading, connect 'Hold 1' to VDD. Do not leave this pin floating or it will drift in and out of hold mode.

### ORDERING INFORMATION

OEM33	3.5 digit, 200mV LCD Voltmeter
-------	--------------------------------

### ELECTRICAL CHARACTERISTICS T<sub>A</sub> = 25°C

CHARACTERISTIC	CONDITION	MIN	TYP	MAX	UNITS
Supply voltage (VDD)	9 Volts		9	10	V
	5 Volts	4.5	5	6	V
Supply Current (IDD)	9 Volts		500	900	μA
	5 Volts			5	mA
Full scale				199.9	mV
Input Impedance		100			MΩ
Reference Voltage	9 Volts		100		mV
Overload voltage				20	V
Zero I/P Reading			0	+1	Counts
Accuracy at FSD	9 Volts		±2	±4	Counts
	5 Volts		±2	±4	Counts
Linearity	9 Volts		±1	±2	Counts
	5 Volts		±1	±2	Counts
Resolution			100		μV
CMRR			70		dB
Temp Coefficient			100	150	ppm/°C

### PIN FUNCTIONS

VDD	Positive supply terminal
VSS	Negative supply terminal for 9 volts operation
GD	Negative supply terminal for 5 volts operation
IH	Input high terminal
IL	Input low terminal
RH	Reference high input terminal
RL	Reference low input terminal
HOLD1	Connect to VDD for hold and GD for continuous
C	Analogue Common
XBP	For driving annunciator
BP	LCD back plane
D1, D2, D3	Decimal point pins . D1 = .000, D2 = 0.00 D3 = 00.0 The decimal point will appear if the corresponding terminal is connected to XBP.
BAT, °C, °F, ~, m, μ, MΩ, KΩ, V, A, HOLD2	Annunciators

All annunciators not in use must be connected to the BP pin for suppression purposes. To light up an annunciator, connect the corresponding pin to XBP.

## USER INSTRUCTIONS

The OEM33 is designed for 5/9V supply. Incorrect supply polarity will destroy the module immediately. It is ready for general use when connected as in fig. 1 for 5V. For 9V supply the module may need calibrating before use as follows. Connect as in fig. 2, apply 100mV to the inputs from a calibrated source and adjust VR1 until the display reads 1000. The input range is 0-199.9mV. Over-range is indicated by displaying a "1" in the most significant digit. If the input voltage is reversed, a minus sign is displayed automatically.

The module has 3 decimal points. D1, D2, D3 and 11 selectable annunciators.

For 5V operation, IL must be connected to GD for non-floating inputs (fig. 1) and to analogue common pin C for floating inputs. In both cases J1 should be closed).

## CONNECTION DIAGRAM BASIC CONFIGURATION

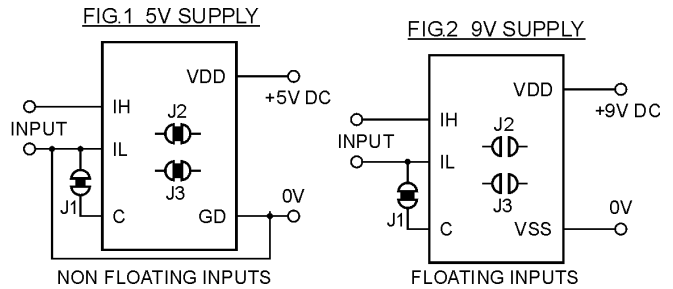

For 9V operation it is recommended to power from a 9V battery. The inputs are intended to float with respect to the supply but if they do not float they must be no closer than 1.5V from either VDD or VSS (VDD-1.5V and VSS+1.5V) see the circuits for non-floating inputs below.

## APPLICATION CIRCUITS

### DC VOLTAGE MEASUREMENT

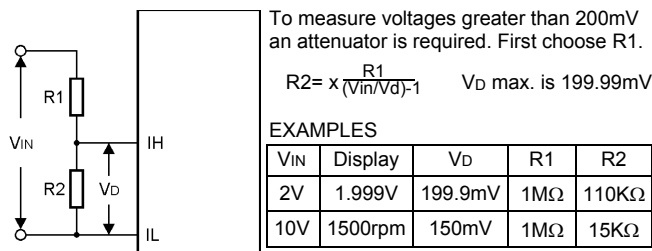

The input impedance becomes R1+R2. Choose accurate stable resistors. Typically, R1=1MΩ. 9MΩ is a practical upper limit.

### DC MULTI-RANGE VOLTAGE MEASUREMENT

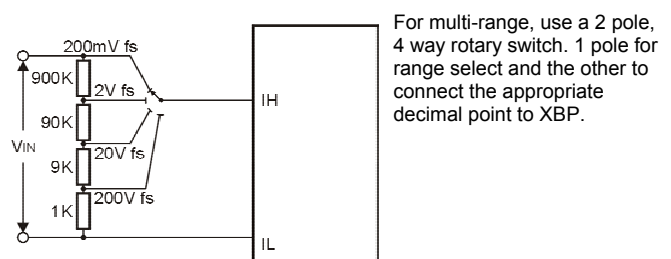

### DC CURRENT MEASUREMENT

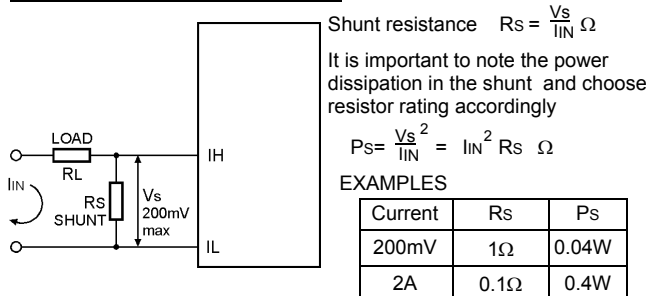

### DC MULTI-RANGE CURRENT MEASUREMENT

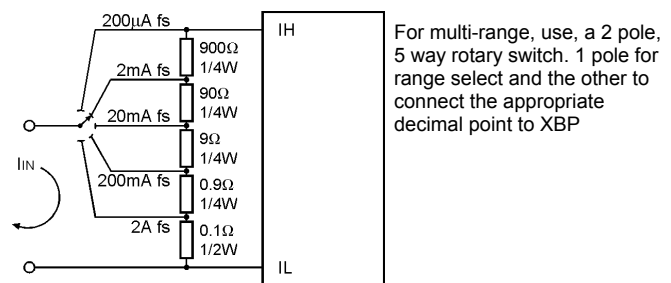

### DC VOLTAGE OFFSET

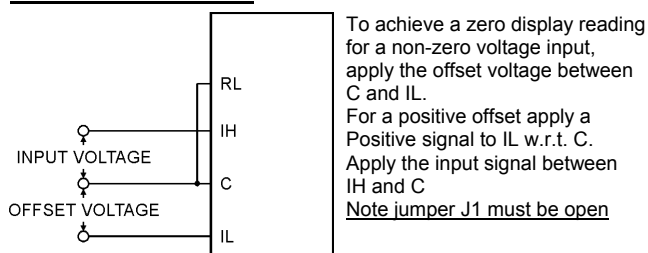

### DC VOLTAGE RATIO MEASUREMENT

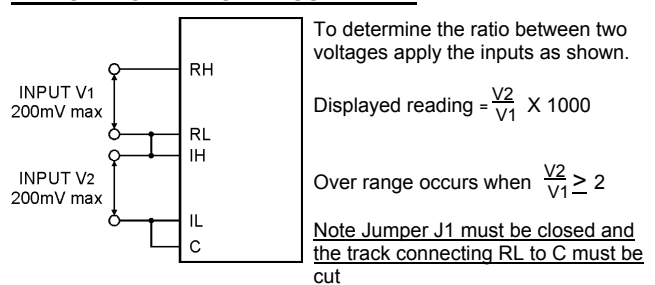

### NON FLOATING INPUTS (a)

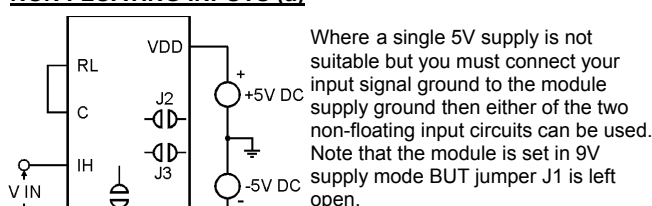

Revision - 14 27/08/04

### NON FLOATING INPUTS (b)

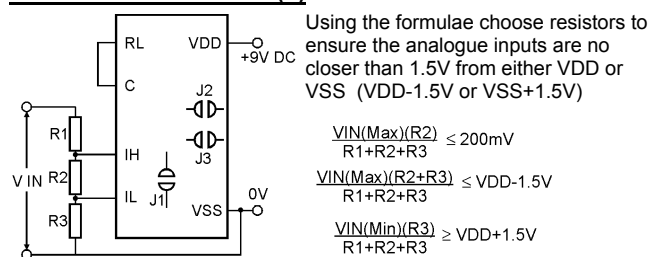

**DETAILED LAYOUT AND DIMENSIONS**

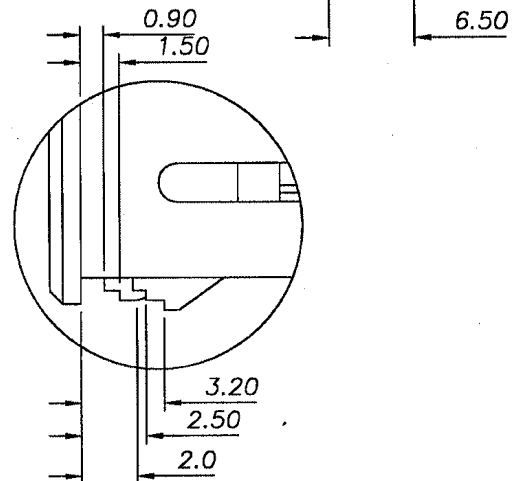
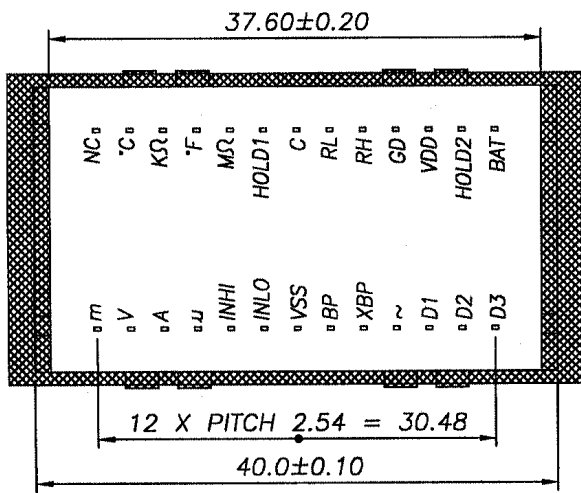
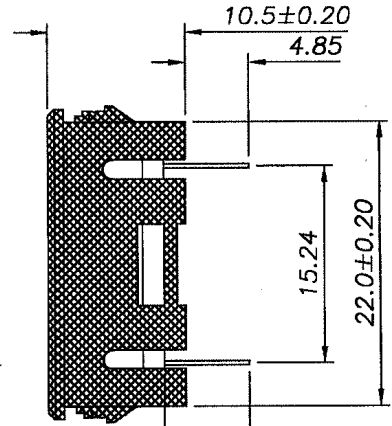
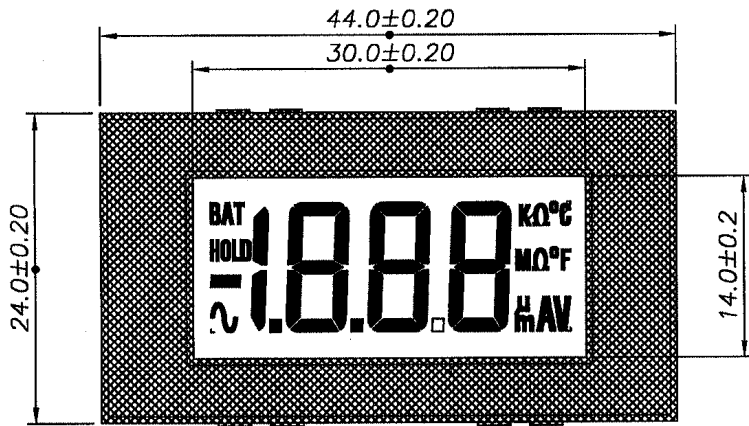

SNAP FASTENING FEATURES TO FIT PANEL OF 0.9mm TO 3.20mm THICKNESS.