

Sensor Immune to Metal Chip Accumulation,  
Ideal for Machine Tool Applications

- Detects work piece properly even when aluminum or iron chips collect on the sensing head during drilling or cutting
- Housing resists water splash and oil contamination to IEC IP67 standards
- Oil-tight cable and operation indicator are standard
- Shielded for flush mounting in metal
- Prewired with 2 meters (6.56 ft) of cable

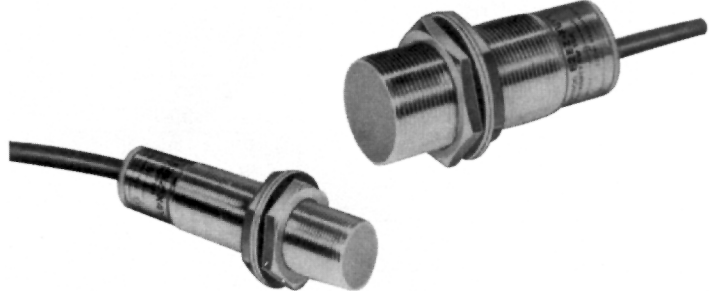

## Ordering Information

### ■ SENSORS

Sensing head	Detecting distance	DC Output		AC Output
		NPN-NO	PNP-NO	NO
M18	4 mm (0.16 in)	<b>E2EZ-X4C1</b>	<b>E2EZ-X4B1</b>	<b>E2EZ-X4Y1</b>
M30	8 mm (0.32 in)	<b>E2EZ-X8C1</b>	<b>E2EZ-X8B1</b>	<b>E2EZ-X8Y1</b>

### ■ ACCESSORIES

Description		Part number
Mounting brackets	Fits M18 size sensors	<b>Y92E-B18</b>
	Fits M30 size sensors	<b>Y92E-B30</b>
Protective covers for shielded sensors	Fits M18 size sensors	<b>Y92E-E18-2</b>
	Fits M30 size sensors	<b>Y92E-E30-2</b>

### ■ REPLACEMENT PARTS

Description		Part number
Mounting hardware including one pair of metal nuts and washers	Fits M18 size sensors (supplied with each sensor)	<b>M18-MHWS</b>
	Fits M30 size sensors (supplied with each sensor)	<b>M30-MHWS</b>

# Specifications

Part number		E2EZ-X4□□	E2EZ-X8□□
Sensor type		Inductive	
Body	Size	M18	M30
	Type	Shielded	
Supply voltage		100 to 240 VAC, 50/60 Hz or 10 to 30 VDC, max. ripple 10% peak-to-peak	
Current consumption		AC: 2 mA max. at 100 VAC, 3 mA max. at 200 VAC DC: 15 mA max.	
Detectable object type		Ferrous metals	
Effective detecting distance (with standard target)		4 mm ±10% (0.16 in)	8 mm ±10% (0.32 in)
Usable detecting range (with standard target)		0 to 3.2 mm (0 to 0.13 in)	0 to 6.5 mm (0 to 0.26 in)
Standard target size aluminum (L x W x H)		30 x 30 x 1 mm (1.18 x 1.18 x 0.04 in)	54 x 54 x 1 mm (2.13 x 2.13 x 0.04 in)
Differential travel		20% max. of effective detecting distance	
Control output	AC solid- state	Type	SCR-NO (E2EZ-X□Y1)
		Max. load	10 to 200 mA
		Max. ON-state voltage drop	See graph in Engineering Data section
		Max. OFF-state leakage current	See graph in Engineering Data section
	DC solid- state	Type	NPN-NO (E2EZ-X□C1) PNP-NO (E2EZ-X□B1)
		Max. load	100 mA max. at 12 VDC, 200 mA max. at 24 VDC
Max. ON-state voltage drop		2 VDC	
Response frequency	AC	5 Hz	5 Hz
	DC	12 Hz	8 Hz
Circuit protection	AC	Not provided	
	DC	Output short circuit, surge voltage, reverse polarity	
Indicators		Target present (red LED)	
Materials	Housing	Nickel-plated brass	
	Sensing face	ABS	
Mounting		Two M18 nuts included. Bracket Y92E-B18 optional.	Two M30 nuts included. Bracket Y92E-B30 optional.
Connections	AC	2-conductor cable, 2 m (6.56 ft) length	
	DC	3-conductor cable, 2 m (6.56 ft) length	
Weight		170 g (6.0 oz.)	270 g (9.5 oz.)
Enclosure ratings	UL	—	
	NEMA	1, 4X, 6, 12, 13	
	IEC 144	IP67	
Approvals	UL	—	
	CSA	—	
Ambient operating temperature		0° to 50°C (32° to 122°F)	
Vibration		10 to 55 Hz, 1.5 mm (0.06 in) double amplitude for 2 hours each in X, Y, and Z directions	
Shock		Approx. 100 G's, 10 times each in X, Y, and Z directions	

# Operation

## OUTPUT CIRCUIT DIAGRAMS AND CONNECTIONS

### NPN Output Type

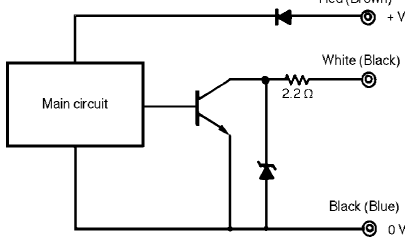

### PNP Output Type

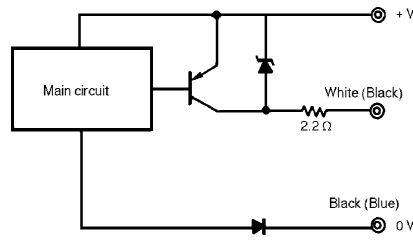

### SCR Output Type

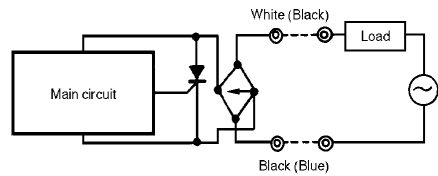

Note: IEC colors are shown in parentheses.

## TIMING CHARTS

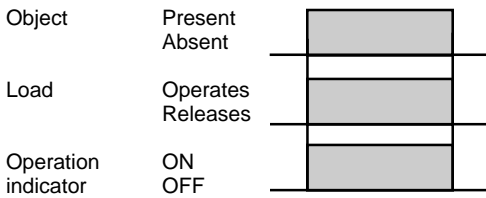

# Engineering Data

## OPERATING RANGE

### E2EZ-X4□□

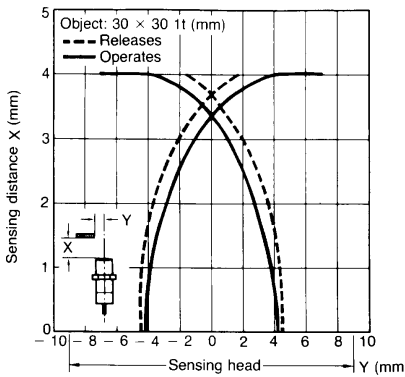

### E2EZ-X8□□

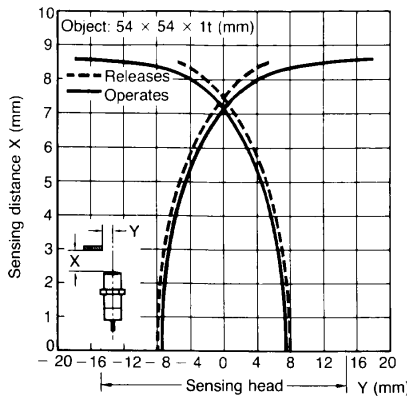

## ELECTRICAL REQUIREMENTS FOR AC SENSORS (E2EZ-X□Y1)

### Residual Load Voltage Characteristics

100 VAC

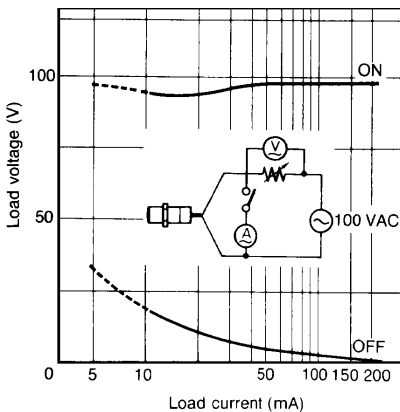

200 VAC

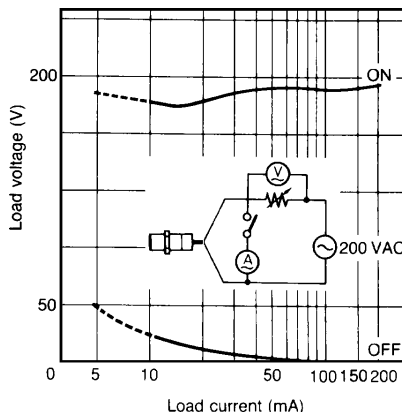

### OFF-State Leakage Current

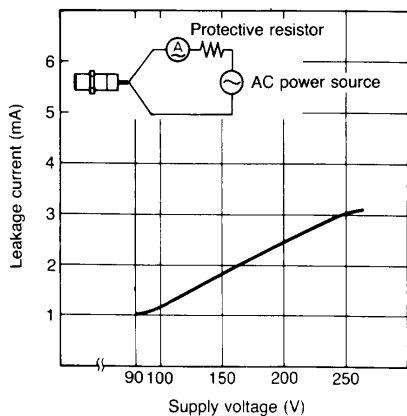

# Dimensions

Unit: mm (inch)

## E2EZ-X4□1

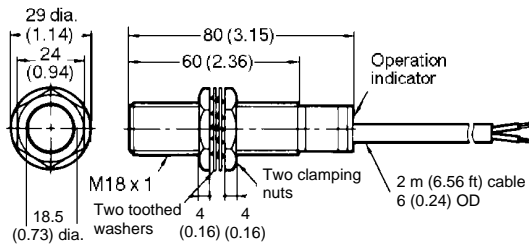

## E2EZ-X8□1

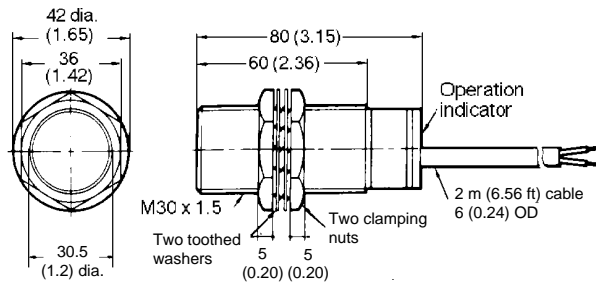

# Precautions

## ■ EFFECTS OF SURROUNDING METALS

When mounting a proximity sensor flush with a metallic panel, provide the minimum distance shown. This prevents the sensor from being affected by metallic objects other than the target.

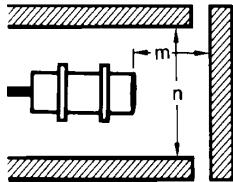
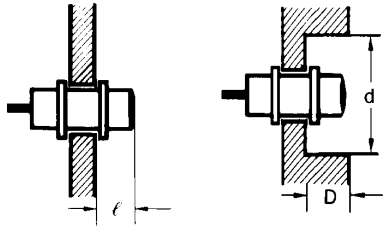

### For Iron

Model	E2EZ-X4□□	E2EZ-X8□□
l	0	0
d	18 mm (0.71 in)	30 mm (1.18 in)
D	0	0
m	16 mm (0.63 in)	32 mm (1.26 in)
n	27 mm (1.06 in)	45 mm (1.77 in)

### For Aluminum

Model	E2EZ-X4□□	E2EZ-X8□□
l	5 mm (0.20 in)	10 mm (0.39 in)
d	40 mm (1.57 in)	70 mm (2.76 in)
D	5 mm (0.20 in)	10 mm (0.39 in)
m	16 mm (0.63 in)	32 mm (1.26 in)
n	54 mm (2.13 in)	90 mm (3.54 in)

## ■ MUTUAL INTERFERENCE

To prevent mutual interference between two sensors mounted opposite or parallel to each other, be sure to space the two sensors at a distance greater than that shown here.

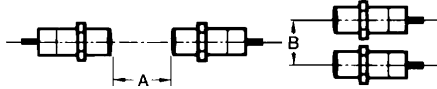

Model	E2EZ-X4□□	E2EZ-X8□□
A	4 cm (1.57 in)	6 cm (2.36 in)
B	5 cm (1.97 in)	10 cm (3.94 in)

## ■ CONNECTION TO AC POWER SOURCE

Be sure to connect the proximity sensor to the power source through a load. Direct connection may damage the sensor.

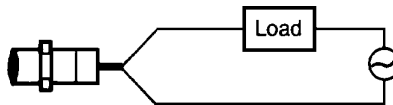

## ■ IMMUNITY AGAINST METAL CHIPS

Even if aluminum or iron chips collect on the sensing head, no signal is produced indicating the detection of metal chips. However, the detection signal may be produced under either of the following two conditions. If a signal is produced from metal chips on the sensing head, remove the chips from the sensing head.

### Large Chips

If the size (d) of the chips collected on the sensing head is greater than or equal to 2/3 of the size (D) of the sensing surface.

$$d \geq 2/3 \times D$$

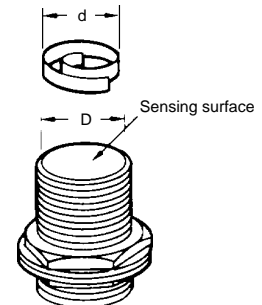

Model	Sensing surface (D)
E2EZ-X4□1	16 mm (0.63 in)
E2EZ-X8□1	28 mm (1.10 in)

### Compressed Chips

If chips are pressed against the sensing surface by an external force the sensor will detect the chips.

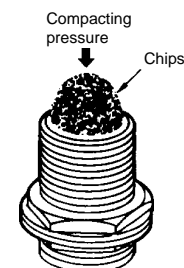



**OMRON ELECTRONICS LLC**

One East Commerce Drive  
Schaumburg, IL 60173

**1-800-55-OMRON**

Cat. No. CEDSAX4

11/01

**OMRON ON-LINE**

Global - <http://www.omron.com>  
USA - <http://www.omron.com/oei>  
Canada - <http://www.omron.com/oci>

Specifications subject to change without notice.

**OMRON CANADA, INC.**

885 Milner Avenue  
Scarborough, Ontario M1B 5V8

**416-286-6465**

Printed in the U.S.A.