

Limit Switches

Catalog
March
07

File 9007 / XC



CONTENTS

Selection Guide	4
Applications by Market Segment	12
Osiswitch® XC Product Overview	14
Osiswitch Miniature Snap Switches	24
Osiswitch Miniature Limit Switches	32
Osiswitch Compact Limit Switches	54
Osiswitch Classic Limit Switches	82
Class 9007 Industrial Snap Switches	152
Class 9007 Miniature Limit Switches	155
Class 9007AW Heavy Duty Industrial Limit Switches	161
Class 9007C Heavy Duty Industrial Limit Switches	162
Class 9007T and FT Severe Duty Mill and Foundry Limit Switches	214
R.B.Denison® Lox-Switch™ L Severe Duty Mill and Foundry Switches	226

Merlín Gerin
Square D
Telemecanique

Schneider
Electric
Building a New Electric World





Limit Switches
Table of Contents
Osiswitch® Limit Switches

Selection Guide	4
Osiswitch® Miniature Snap Switches	24
Osiswitch® Miniature, Metal	32
Osiswitch® Miniature, Plastic	50
Osiswitch® Compact	54
Osiswitch® Compact, Metal	56
Osiswitch® Compact, Plastic	62
Osiswitch® Compact, Metal and Plastic	65
Osiswitch® Compact, Plastic	66
Osiswitch® Compact, Metal and Plastic	70
Osiswitch® Compact with Manual Reset	76
Osiswitch® Classic, Metal	82
Osiswitch® Classic, Metal, Conforming to CENELEC EN 50041	98
Osiswitch® Classic, Plastic, Conforming to CENELEC EN 50041	126
Osiswitch® Classic, For Hoisting, Mechanical Handling, and Conveyer Belt Shift Monitoring	136
Osiswitch® Classic, For Hoisting and Material Handling	138
Osiswitch® Classic, For Material Handling	144

Limit Switches

Selection Guide

Osiswitch® Universal

Design	Miniature		Compact	
				
Catalog number	XCMD	XCKD	XCKP	XCKT
Enclosure	Metal		Plastic, double insulated	
Features	Mounting by the body or by the head			
Modularity	Head, body and connection modularity			Head and body modularity
CENELEC conformity	—	EN 50047		EN 50047 compatible
Body dimensions (w x h x d), mm (in.)	30 x 50 x 16 (1.18 x 1.97 x 0.63)		31 x 65 x 30 (1.22 x 2.56 x 1.18)	
Head	Linear movement (plunger) Rotary movement (lever) Rotary movement, multi-directional Same heads for ranges XCMD, XCKD, XCKP and XCKT			
Contact blocks	2 snap action contacts with positive opening operation	N/C + N/O; N/C + N/C		N/C + N/O
	3 snap action contacts with positive opening operation	N/C + N/C + N/O	N/C + N/C + N/O; N/C + N/O + N/O	
	4 snap action contacts with positive opening operation	N/C + N/C + N/O + N/O	—	
	2 slow break contacts with positive opening operation	N/C + N/O break before make	N/C + N/O break before make; N/O + N/C make before break; N/C + N/C simultaneous	
	2 slow break contacts	—	N/O + N/O simultaneous	
	3 slow break contacts with positive opening operation	N/C + N/C + N/O break before make	N/C + N/C + N/O break before make; N/C + N/O + N/O break before make	
Insulation voltage (Ui) / thermal current (Ithe)	Pre-cabled 2 contacts: 400 V/6 A 3 contacts: 400 V/4 A 4 contacts: 400 V/3 A		Screw terminal 2 contacts: 500 V/10 A 3 contacts: 400 V/6 A	
Connector	Integral M12, 4-pin: 250 V/3 A Integral M12, 5-pin: 60 V/4 A Remote 7/8" 16UN: 250 V/6 A	Integral M12, 5-pin: 60 V/4 A	Integral M12, 4-pin: 250 V/3 A	—
Degree of protection	NEMA Types 1, 2, 4X, 6, 12 IP 66, IP 67, IP 68, IK 06	NEMA Types 1, 2, 4, 6, 12, 13 IP 66, IP 67, IK 06	NEMA Types 1, 2, 4, 6, 6P, 12, 13 IP 66, IP 67, IK 04	NEMA Types 1, 2, 4, 6, 12, 13 IP 66, IP 67, IK 04
Connection	Screw terminals	—	1 entry for ISO M16 or M20, PG 11, PG 13 conduit thread or 1/2" NPT, PF 1/2	
	Pre-cabled	Integral: No Remote: Yes	—	
	Connector	Integral or remote M12 or remote 7/8" 16UN	Integral M12	
Page	44	56 and 60	62 and 66	68

Limit Switches

Selection Guide

Osiswitch® Optimum and Application

Design	Miniature Optimum	Compact Application: with manual reset		
--------	-------------------	--	--	--



Catalog number	XCMN	XCDR	X CPR	XCTR
Enclosure	Plastic, double insulated	Metal	Plastic, double insulated	
Features	Mounting by the body or by the head	Mounting by the body		
Modularity	—			
CENELEC conformity	—			
Body dimensions (w x h x d), mm (in.)	30 x 50 x 16 (1.18 x 1.97 x 0.63)	31 x 65 x 30 (1.22 x 2.56 x 1.18)	58 x 51 x 30 (2.28 x 2.01 x 1.18)	
Head	Linear movement (plunger) Rotary movement (lever) Rotary movement, multi-directional	Linear movement (plunger) Rotary movement (lever) Same heads for ranges XCDR, X CPR and XCTR		
Contact blocks	2 snap action contacts with positive opening operation	N/C + N/O		
	3 snap action contacts with positive opening operation	—		
	4 snap action contacts with positive opening operation	—		
	2 slow break contacts with positive opening operation	—	N/C + N/O break before make	
	2 slow break contacts	—		
Insulation voltage (Ui) / thermal current (Ithe)	Screw terminal 2 contacts: 400 V/6 A	Screw terminal 2 contacts: 500 V/10 A		
	Connector	—		
Degree of protection	NEMA Types 1, 2, 13 IP 65, IK 04	IP 66, IP 67, IK 04		
Connection	Screw terminals	—	1 entry for ISO M20 or PG 13 conduit thread or 1/2" NPT	2 entries for ISO M16 or PG 11 conduit thread or 1/2" NPT (using adapter)
	Pre-cabled	Yes	—	
	Connector	—		
Page	52	76	78	80

Limit Switches

Selection Guide

Osiswitch® Classic

Design **Classic**



Catalog number	XCKM	XCKL	XCKJ
Enclosure	Metal		
Features	3 conduit entries		Fixed or plug-in body, -40 °C (-40 °F) or +120 °C (+248 °F) versions
Modularity	Head + Body + Operator		
CENELEC or DIN conformity	—		EN 50041
Body dimensions (w x h x d), mm (in.)	63 x 64 x 30 (2.48 x 2.52 x 1.18)	52 x 72 x 30 (2.05 x 2.83 x 1.18)	40 x 77 x 44 (1.57 x 3.03 x 1.73) 42.5 x 84 x 36 (1.67 x 3.31 x 1.42)
Head	Linear movement (plunger) Rotary movement (lever) Rotary movement, multi-directional		
Contact blocks	2 snap action contacts with positive opening operation	N/C + N/O; N/C + N/C	N/C + N/O
	3 snap action contacts with positive opening operation	N/C + N/C + N/O; N/C + N/O + N/O	
	C/O snap action contacts	—	
	C/O slow break contacts	—	
	2 slow break contacts with positive opening operation	N/C + N/O break before make N/O + N/C make before break N/C + N/C simultaneous	
2 slow break contacts	N/O + N/O simultaneous		
3 slow break contacts with positive opening operation	N/C + N/C + N/O break before make; N/C + N/O + N/O break before make		
Insulation voltage (Ui) / thermal current (Ithe)	Screw terminal 2 contacts: 500 V/10 A 3 contacts: 400 V/6 A		—
	—		Connector Integral M12, 5-pin: 60 V/4 A Integral 7/8" 16UN: 250 V/6 A
Degree of protection	NEMA Types 1, 2, 4, 6, 6P, 12, 13 IP 66, IK 06		NEMA Types 1, 2, 4, 12 IP 66 IK 07
Connection	Screw terminals (cable entry)	3 entries for ISO M20 or PG 11 conduit thread or 1/2" NPT	1 entry incorporating cable entry or tapped 1/2" NPT
	Connector	—	
Page	82	82	98

Limit Switches

Selection Guide

Osiswitch® Classic, Application, and Miniature Snap Switches

Design	Classic	Application: for installations requiring electrical redundancy	Application: for lifting and materials handling equipment or very severe applications	Sub-miniature, miniature: applications requiring high precision and a low operating force
--------	---------	--	---	---



Catalog number	XCKS	XCKML	XCR, XC1AC	XEP, XCO	
Enclosure	Plastic, double insulated	Metal	Metal or polyester	Plastic	
Features	—	2 sets of contacts	—	Depending on type	
Modularity	Head + Body + Operator		Fixed composition	Depending on type, fixed composition or contact and operator	
CENELEC or DIN conformity	EN 50041	—	—	—	
Body dimensions (w x h x d), mm (in.)	40 x 72.5 x 36 (1.57 x 2.85 x 1.42)	72 x 81 x 36 (2.83 x 3.19 x 1.42)	Depending on type	DIN 41635, depending on type	
Head	Linear movement (plunger) Rotary movement (lever) Rotary movement, multi-directional	Linear movement (plunger) Rotary movement (lever)	—	Linear movement (plunger)	
Contact blocks	2 snap action contacts with positive opening operation	N/C + N/O; N/C + N/C	2 x N/C + N/O contact blocks	Depending on type	
	3 snap action contacts with positive opening operation	N/C + N/C + N/O; N/C + N/O + N/O	—	—	
	C/O snap action contacts	2 C/O	—	Depending on type	1 single-pole contact
	C/O slow break contacts	—	—	Depending on type	—
	2 slow break contacts with positive opening operation	N/C + N/O break before make N/O + N/C make before break N/C + N/C simultaneous	2 x N/C + N/O break before make contact blocks	Depending on type	—
	2 slow break contacts	N/O + N/O simultaneous	—	—	—
Insulation voltage (Ui) / thermal current (Ithe)	3 slow break contacts with positive opening operation	N/C + N/C + N/O break before make N/C + N/O + N/O break before make	—	—	
	—	Screw terminal 2 contacts: 500 V/10 A 3 contacts: 400 V/6 A	Screw terminal 2 contacts: 500 V/10 A	Depending on type	
Degree of protection	IP 65 IK 03	NEMA Types: 1, 2, 4, 6, 6P, 12, 13 IP 66 IK 06	Depending on type: IP 66, IK 05; IP 65, IK 05; or IP 54, IK 05	Depending on type	
Connection	Screw terminals (cable entry)	1 entry for ISO M20 or PG 13 conduit thread	3 entries for ISO M20 or PG 13 conduit thread; or PG 13 to 1/2" NPT with adapter	Depending on type: 1 or 3 entries for ISO M20 or PG 13 conduit thread	
	Connector	—	—	Depending on type: by tags or pre-wired	
Page	126	82	136 and 144	26	

Limit Switches

Selection Guide

Class 9007 Industrial Snap Switches and Miniature Industrial Switches

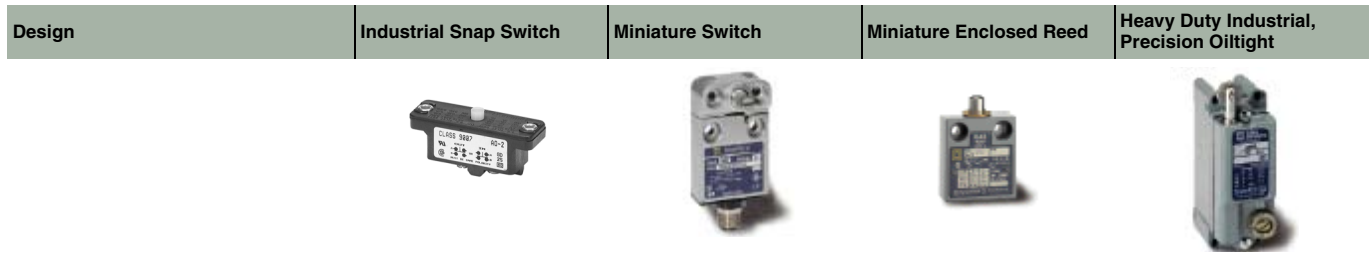

Catalog Number Prefix	9007A 9007C	9007MS 9007ML	9007XA	9007AW
Description	Industrial snap switches with or without operators	Miniature enclosed switches, potted and pre-wired with cable. Unique rotary head. 9007 ML has double break contacts.	Miniature enclosed switches, potted and pre-wired with cable. Reed contacts for superior low-energy switching.	Precision oil tight enclosed switches with unique features, micrometer adjustable and low temperature operation.
Enclosure Material	Plastic	Metal bodies, metal head	Metal bodies, metal head	Metal bodies, metal heads
Enclosure Rating	None	NEMA: Types 1, 2, 4, 6, 6P, 12, 13 IEC: IP67	NEMA: Types 1, 2, 4, 6, 6P, 12, 13	NEMA: Types 1, 2, 4, 6, 6P, 12, 13
Approximate Body Dimensions, mm (in.)	29.0 x 63.5 x 21.0 (1.14 x 2.5 x 0.83)	40.1 x 44.4 x 15.8 (1.58 x 1.75 x 0.62)	40.1 x 44.2 x 16.0 (1.58 x 1.74 x 0.63)	36.6 x 98.5 x 63.5 (1.44 x 3.88 x 2.5)
Heads	Linear	Linear or Rotary	Linear or Rotary	Linear or Rotary
Contact Blocks				
N.C. + N.O. snap action	X	X	N.O. or N.C.	X
N.C. + N.O. break before make, slow break				
N.O. + N.C. make before break, slow break				
N.C. + N.C. simultaneous, slow break				
N.O. + N.O. simultaneous, slow break				
C/O snap action				
C/O slow break				
N.C. + N.C. 2-step, slow break				
N.O. + N.O. 2-step, slow break				
N.C. + N.C. snap action				
N.O. + N.C. slow make, slow break				
Cabling		Pre-wired cable, M12 Connector option available.	Pre-wired cable.	
Temperature Range	-65 to +221 °F (-54 to +105 °C)	-40 to +221 °F (-40 to +105 °C)	-20 to +140 °F (-29 to +60 °C)	0 to +185 °F (-17.8 to 85 °C) Lever operated: -65 to +185 °F (-54 to 85 °C)
Additional Features	A variety of operators are available, page 152	Bottom or side cable entry. Full range of operating heads, page 156.	Bottom cable entry. Three common operating heads, page 160.	Most common operating heads. Micrometer adjustable push rod plunger. Uses 9007C levers, page 190.

Limit Switches

Selection Guide

Class 9007 Type C Heavy Duty Industrial

Applications	Material handling—mechanical conveying, automotive, machine tool, packaging			Hazardous application locations: gases (explosion), dust environment.
Design	Standard body type 9007C****	Standard body reed contacts	Compact body type 9007C52**	Hazardous location body type 9007CR****



Catalog number	9007C54*** 9007C62*** 9007C68*** 9007C66***	9007C84*** 9007C86***	9007C52**	9007CR53** 9007CR61** 9007CR65** 9007CR67**
Enclosure	Metal, diecast, zinc alloy			
Features	Plug-in body			Non-plug-in body
Factory modifications (Forms)	See pages 176 to 180			
Modularity	Head + body + lever			
Conforming to standards	NEMA 250, EN 60947-1, EN 60947-5-1, IEC 60947, UL 508, C22-2-14-95, CE conformity documentation			NEMA 250, EN 60947-1, EN 60947-5-1, IEC 60947, UL 508, C22-2-14-95, CE conformity documentation
Product certifications	UL, CSA, CE			
Body dimensions (w x h x d), mm (in.) with rotary head	39 x 102 x 45 (1.54 x 4.02 x 1.77)		39 x 80 x 45 (1.54 x 3.15 x 1.77)	69 x 156 x 53 (2.72 x 6.14 x 2.10)
Head	Linear movement (plunger) Rotary movement (lever) Multi-directional movement (wobble stick, cat whisker)			
Contact blocks	Snap action contacts		1 N.O. + 1 N.C.	9007CR53** 1 N.O. + 1 N.C.
	Direct opening (positive opening)			9007CR61** 2 N.O. + 2 N.C.
		9007C62*** 2 N.O. + 2 N.C.	Reed contacts 1 N.O. or 1 N.C.	9007CR65** 2 N.O. + 2 N.C. neutral position
		9007C68*** 2 N.O. + 2 N.C. neutral position		9007CR67** 2 N.O. + 2 N.C. two stage
		9007C66*** 2 N.O. + 2 N.C. two stage		
		9007C**** Y1561 (→) Plunger and lever heads only Single pole only	9007C52** Y1561 (→) Single pole only	9007CR**** Y1561 (→) Single pole only
Rated insulation voltage	600 V		—	
Insulation voltage (Ui)—top half of body	600 V Except: 9007CO62, 9007CO66, 9007CO68 (Ui = 250 V) and 9007C84, 9007C86 (Ui = 125 V)		600 V	600 V Except: 9007CR63, 9007CR65, 9007CR67 (Ui = 250 V)
Thermal current (Ithe)—top half of body	10 A Excepted: 9007CO84, 9007CO86 (2.5 A)		10 A	10 A
Degree of protection	IP 67 conforming to IEC 60529, NEMA Types 2, 4, 6, 6P, 12, 13		IP 67 conforming to IEC 60529 NEMA Types 2, 4, 6, 6P, 12, 13,	NEMA Types 2, 4, 6P, 7, 9, 13
Connection (1)	Cable entry or connector Depending on model: 1/2"-14 NPT, M20 x 1.5 ISO cable entry, 5-pin mini connector.		Cable entry or connector Depending on model: 1/2"-14 NPT, M20 X 1.5 ISO cable entry, 5 pin mini connector.	Cable entry or connector Depending on model: 1/2"-14 NPT, M20 X 1.5 ISO cable entry, 3/4 14 NPT available.
Page	164		172	198

1. A wide range of connectors are available. Contact your local field office.

Limit Switches

Selection Guide

Severe Duty Mill and Foundry Switches

Applications	Mill	Mill	Mill	Mill
Design	9007T Convertible sequence	L100 Fixed sequence	L14 Single Cable Pulls Fixed sequence	L525 Belt Conveyor Fixed sequence



Catalog number	9007T***	L100***	L14	L525
Enclosure	Metal	Metal	Metal	Metal
Features	Extra heavy duty contact ratings	Extra heavy duty contact ratings	Extra heavy duty contact ratings	Extra heavy duty contact ratings
Factory modifications (Forms)	Page 221	Page 237	Page 237	Page 237
Conforming to standards Product	NEMA A600 UL508	NEMA A600 UL508	NEMA A600 UL508	NEMA A600 UL508
Product certifications	UL Listed, CSA Certified	UL Listed, CSA Certified	UL Listed, CSA Certified	UL Listed, CSA Certified
Body dimensions (w x h x d), mm (in.) surface mounting	58.7 x 114.3 x 64.5 (2.31 x 4.5 x 2.54)	58.7 x 126 x 53.3 (2.31 x 4.95 x 2.10)	58.7 x 126 x 53.3 (2.31 x 4.95 x 2.10)	58.7 x 126 x 53.3 (2.31 x 4.95 x 2.10)
Head	Rotary movement (lever)	Rotary movement (lever)	Rotary movement (lever) (3)	Rotary movement (lever) (3)
Contact blocks	Snap action contacts (1)			
	Sequences			
Rated insulation voltage	600 V	600 V	600 V	600 V
Thermal current (Ithe)	20 A ac/dc	20 A ac, 5 A dc	20 A ac, 5 A dc	20 A ac, 5 A dc
Degree of protection	NEMA Types 1, 2, 4, 12, 13 IP65, 66, 67	NEMA Types 1, 4, 13 IP65, 66	NEMA Types 1, 4, 13 IP65, 66	NEMA Types 1, 4, 13 IP65, 66
Connection (2)	Cable entry or connector 1/2" NPT (metric available)	Cable entry or connector 1/2" NPT (metric available)	Cable entry or connector 1/2" NPT (metric available)	Cable entry or connector 1/2" NPT (metric available)
Presentation, Applications and Characteristics	Page 216	Page 228	Page 232	Page 233
Interpretation of Catalog Numbers	Page 239	Page 239	Page 239	Page 239

1. For other contact options see page 216.
2. A wide range of connectors are available. Contact your local field office.
3. Lever arms are optional and must be ordered separately.

Limit Switches

Selection Guide

Severe Duty Mill and Foundry Switches

Applications	Foundry	Foundry	Mill and Foundry
Design	9007FT Convertible sequence	L300 Fixed sequence	L2153 Dual Pull Stop Fixed sequence



Catalog number	9007FT**	L300**	L2153
Enclosure	Metal	Metal	Metal
Features	Designed specifically for rough foundry applications	Designed specifically for rough foundry applications	Extra heavy duty contact ratings
Factory modifications (Forms)	Page 221	Page 237	Page 237
Conforming to standards	NEMA A600 UL508	NEMA A600 UL508	NEMA A600 UL508
Product certifications	UL Listed, CSA Certified	UL Listed, CSA Certified	UL Listed, CSA Certified
Body dimensions (w x h x d), mm (in.) surface mounting	58.7 x 114.3 x 86.6 (2.31 x 4.5 x 3.41)	58.7 x 126 x 53.3 (2.31 x 4.95 x 2.10)	58.7 x 126 x 53.3 (2.31 x 4.95 x 2.10)
Head	Rotary movement (lever)	Rotary movement (lever)	Rotary movement (lever) (2)
Contact blocks	1 N.C. + 1 N.O.	1 N.C. + 1 N.O.	1 N.C. + 1 N.O.
Snap action contacts ♦ Sequences	Convertible	Fixed	Fixed
Rated insulation voltage	600 V	600 V	600 V
Thermal current (Ithe)	20 A ac/dc	20 A ac, 5 A dc	20 A ac, 5 A dc
Degree of protection	NEMA Types 1, 2, 4, 12, 13 IP65, 66, 67	NEMA Types 1, 4, 13 IP65, 66	NEMA Types 1, 4, 13 IP65, 66
Connection (1)	Cable entry or connector 1/2" NPT (metric available)	Cable entry or connector 1/2" NPT (metric available)	Cable entry or connector 1/2" NPT (metric available)
Presentation, Applications and Characteristics	Page 218	Page 230	Page 232
Interpretation of Catalog Numbers	Page 239	Page 239	Page 239

1. A wide range of connectors are available. Contact your local field office.
2. Lever arms are optional and must be ordered separately.

Limit Switches Selection Guide Applications by Market Segment

Crane and Hoist

- Overhead Cranes
- Transport Systems

Mill and Foundry

- Iron and Steel
- Cement and Glass

Process Machinery

- Machine Tools
- Plastic, Rubber, Molding
- Printing
- Textile
- Pulp, Paper, Wood

Material Handling

- Conveyance
- Carousels
- Automatic Storage/Retrieval

Packaging Machinery

- Packaging Machines
- Shrink Wrap

Food and Beverage Machinery

- Bottling
- Canning

Simple Machines

- Transportation Wash
- Light Handling
- Assembly Stations
- General Purpose

Electric Lifts

- Lifting Platforms
- Elevators
- Escalators

NOTE: Special electrical options available for:

- Low current switching for programmable controllers
- Hazardous locations



XCKP
XCKT
XCKD

XCKM
XCKL
XCKML

XCMD
9007MS/ML
9007XA

XCKS

**Limit Switches
Selection Guide
Applications by Market Segment**



9007AW

**XCKJ
9007C**

**L100/L300
9007T/FT**

**XCR
9007CLS**

Limit Switches

Limit Switches

Selection Guide

Osiswitch® XC Product Overview

Introduction

Electromechanical detection

Limit switches are used in all automated installations and also in a wide variety of applications, due to the numerous advantages inherent to their technology.

They transmit data to the logic processing system regarding:

- presence/absence
- passing
- positioning
- end of travel

Simplicity of installation, advantages

From an electrical viewpoint

- galvanic separation of circuits,
- models suitable for low power switching, combined with good electrical durability,
- very good short-circuit withstand in coordination with appropriate fuses,
- total immunity to electromagnetic interference,
- high rated operational voltage.

From a mechanical viewpoint

- N/C contacts with positive opening operation,
- high resistance to the different ambient conditions encountered in industry (standard tests and specific tests under laboratory conditions),
- high repeat accuracy, up to 0.01 mm on the tripping points.

Detection movements

- Linear movement (plunger)
- Rotary movement (lever)
- Multi-directional movement

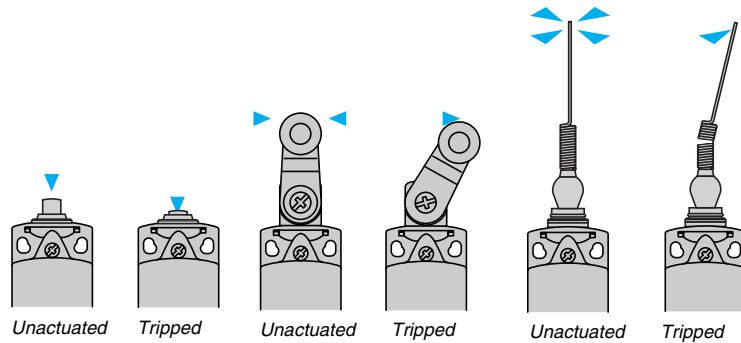

Terminology

Rated value of a quantity

- This replaces the term "nominal value".
- It is the fixed value for a specific function.

Utilization categories

- AC-15 replaces AC-11: control of an electromagnet on a.c., test 10 le/le.
- AC-12: control of a resistive load on a.c. or static load isolated by opto-coupler.
- DC-13 replaces DC-11: control of an electromagnet on d.c., test le/le.
- Ithe is no longer a rated value but a conventional current used for heating tests.

Switching capacity

Example: for category A300 the corresponding operational current, I_e maximum, is 6 A-120 V or 3 A-240 V, the equivalent I_{the} being 10 A.

Positive opening travel

- Minimum travel from the initial movement of contact actuator to the position required to accomplish positive opening operation.

Positive opening force

- The force required on the contact actuator to accomplish positive opening operation.

Positive opening operation

- A limit switch complies with this specification when all the closed contact elements of the switch can be changed, with certainty, to the open position (no flexible link between the moving contacts and the operator of the switch, to which an actuating force is applied).
- All limit switches incorporating either a slow break contact block or a snap action N/C + N/O (form Zb), N/C + N/O + N/O, N/C + N/C + N/O, N/C + N/C + N/O + N/O contact block are positive opening operation, in complete conformity with standard IEC 60947-5-1 Appendix K.

Limit Switches

Selection Guide

Osiswitch® XC Product Overview

Contact blocks

Snap action contacts

- Snap action contacts are characterized by different tripping and reset points (differential travel).
- The displacement speed of the moving contacts is not related to the speed of the operator.
- This feature ensures satisfactory electrical performance in applications involving low speed actuators.

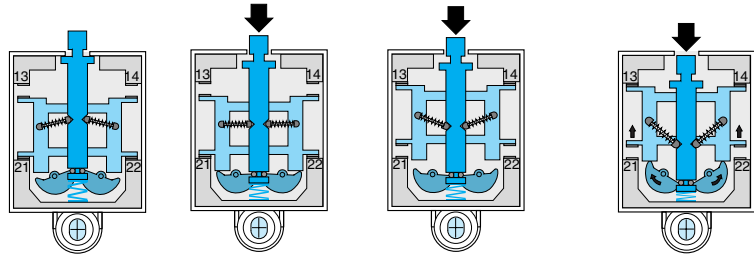

Unactuated state Approach travel Contact change of state Positive opening

Slow break contacts

- Slow break contacts are characterized by identical tripping and resetting points.
- The displacement speed of the moving contacts is equal, or proportional, to the speed of the operator—which must not be less than 0.1 m/s, or 6 m/minute (0.33 ft/s, or 19.68 ft/minute).
- The opening distance also depends on the distance traveled by the operator.

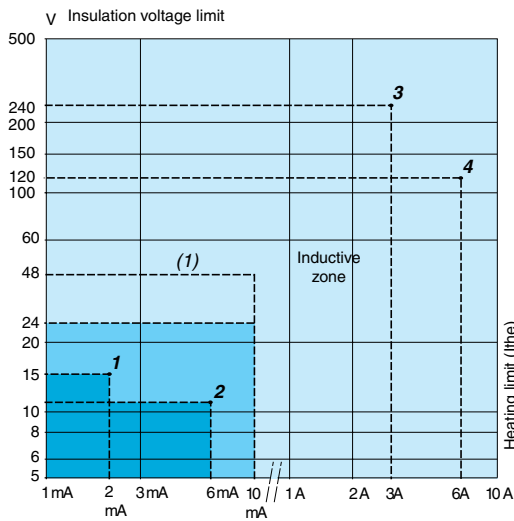
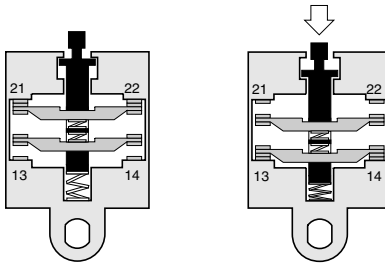

Electrical durability for normal loads

- Normally, for inductive loads, the current value is less than 0.1 A (sealed), i.e. values of 3 to 40 VA sealed and 30 to 1000 VA inrush, depending on the voltage.

For this type of application the electrical durability exceeds 10 million operating cycles.

Application example: XCKJ161 + LC1D12*** (7 VA sealed, 70 VA inrush).

Electrical durability = 10 million operating cycles.

Switching capacity

1. Normal industrial PLC input type 1
2. Normal industrial PLC input type 2
3. Switching capacity conforming to IEC 60947-5-5, utilization category AC-15, DC-13

A300	240 V	3 A	B300	240 V	1.5 A
Q300	250 V	0.27 A	R300	250 V	0.13 A
4. Switching capacity conforming to IEC 60947-5-1, utilization category AC-15, DC-13

A300	120 V	6 A	B300	120 V	3 A
Q300	125 V	0.55 A	R300	125 V	0.27 A

Electrical durability for small loads

- The use of limit switches with programmable controllers is becoming more common.
- With small loads, limit switches offer the following levels of reliability:
- failure rate of less than 1 for 100 million operating cycles using snap action contacts (contacts XE2SP).
- failure rate of less than 1 for 20 million operating cycles using slow break contacts (contacts XE•NP and XE3SP).
- failure rate of less than 1 for 5 million operating cycles using contacts XCMD.

Range of use	
Standard contacts Continuous service (frequent switching)	XE2SP2151, P3151
	XE2NP***
	Contacts of XCMD, XE3•P***
Gold flashed contacts on resistive load	Occasional service Infrequent switching, ≤ 1 operating cycle/day and/or corrosive atmosphere

1. Usable up to 48 V/10 mA.

Limit Switches

Selection Guide

Osiswitch® XC Product Overview

Principle

Innovation through modularity

- The Miniature design XCMD and Compact design XCKD, XCKP and XCKT product range family benefits from the **Osisconcept™** principle: **Offering simplicity through innovation.**
- A first in worldwide detection for improving productivity.
A complete offer for resolving the most commonly encountered detection problems:
 - product selection simplified,
 - product availability simplified,
 - installation and setup simplified,
 - maintenance simplified.

Heads

- A single metal operating head type for the Miniature design XCMD and Compact design XCKD, XCKP and XCKT ranges.

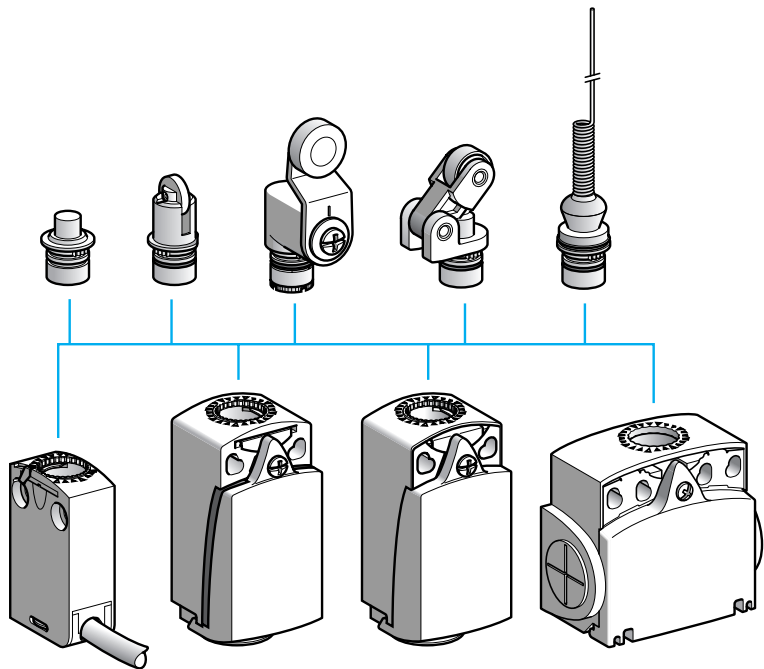

- Interchanging of heads achieved by simple operation of forked metal latch.
- Adjustable in 3 planes:

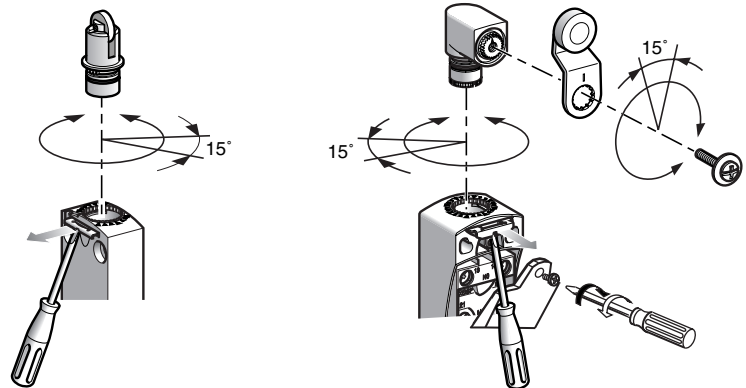

All the heads can be adjusted in 15° steps throughout 360°, in relation to the body.

All the levers can be adjusted in 15° steps throughout 360°, in relation to the horizontal axis of the head.

Limit Switches

Selection Guide

Osiswitch® XC Product Overview

Principle (continued)

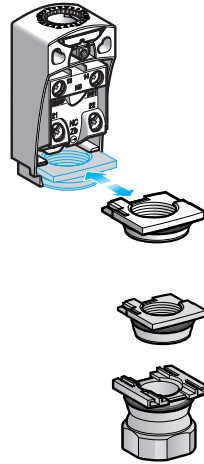

Cable entries

The cable entries for Compact design XCKD and XCKP switches enable:

- simple cabling due to unrestricted access to contacts
- simple adaptation to the various worldwide markets

6 models are available:

- ISO M16 x 1.5
- PG 11
- ISO M20 x 1.5
- PG 13
- 1/2" NPT
- PF 1/2 (G 1/2)

Each model is available in metal or plastic, suited for compact design XCKD or XCKP, respectively. A connector version is also available.

Connection components

- The miniature XCMD range allows interchangeability of these pre-cabled connection components:
 - 1/4 turn is all that is required to remove the connection component on XCMD bodies with 2 and 3 contacts,
 - 6 alternative cable lengths are available.
- The miniature XCMD range also includes an integral or remote connector solution.

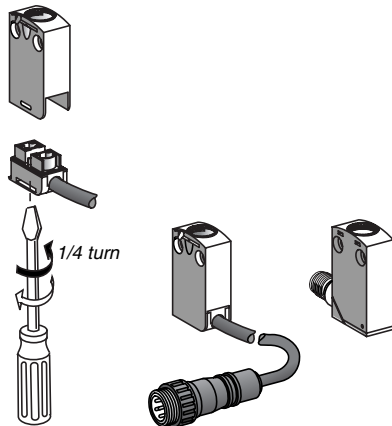

Contact block or body with contacts

- 2 and 3 snap action and slow break contact blocks, with positive opening operation, are interchangeable between the Compact design XCKD and XCKP and Classic XCKJ, XCKS, XCKM and XCKL ranges.
- For the Miniature design XCMD range, the contacts are an integral part of the body:
 - 2 and 3 snap action and slow break contacts, with positive opening operation, and interchangeable connection component,
 - 4 snap action contacts, with positive opening operation, with monolithic body and connection components.

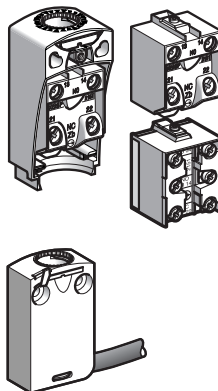

Limit Switches

Selection Guide

Osiswitch® XC Product Overview

Contact blocks (continued)

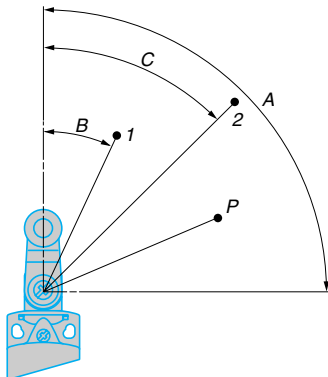
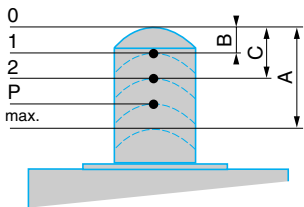
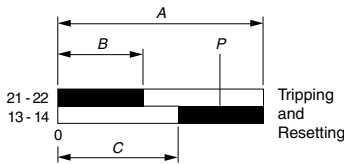
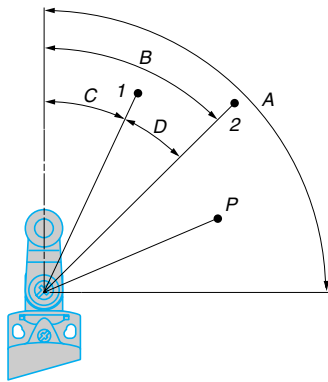
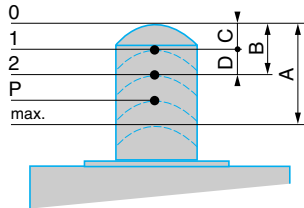
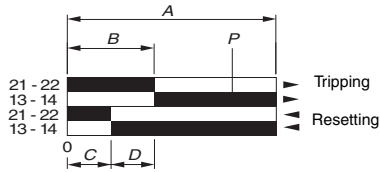

Functional diagrams of snap action contacts

Example: N/C + N/O

- A—Maximum travel of the operator in mm or degrees.
- B—Tripping travel of contact.
- C—Resetting travel of contact.
- D—Differential travel = B–C.
- P—Point from which positive opening is assured.

Linear movement (plunger)

- 1—Resetting point of contact.
- 2—Tripping point of contact.
- A—Maximum travel of the operator in mm.
- B—Tripping travel of contact.
- C—Resetting travel of contact.
- D—Differential travel = B–C.
- P—Point from which positive opening is assured.

Rotary movement (lever)

- 1—Resetting point of contact.
- 2—Tripping point of contact.
- A—Maximum travel of the operator in degrees.
- B—Tripping travel of contact.
- C—Resetting travel of contact.
- D—Differential travel = B–C.
- P—Point from which positive opening is assured.

Functional diagrams of slow break contacts

Example: N/C + N/O break before make

- A—Maximum travel of the operator in mm or degrees.
- B—Tripping and resetting travel of contact 21-22.
- C—Tripping and resetting travel of contact 13-14.
- P—Point from which positive opening is assured.

Linear movement (plunger)

- 1—Tripping and resetting points of contact 21-22.
- 2—Tripping and resetting points of contact 13-14.
- A—Maximum travel of the operator in mm.
- B—Tripping and resetting travel of contact 21-22.
- C—Tripping and resetting travel of contact 13-14.
- P—Positive opening point.

Rotary movement (lever)

- 1—Tripping and resetting points of contact 21-22.
- 2—Tripping and resetting points of contact 13-14.
- A—Maximum travel of the operator in degrees.
- B—Tripping and resetting travel of contact 21-22.
- C—Tripping and resetting travel of contact 13-14.
- P—Positive opening point.

Limit Switches

Selection Guide

Osiswitch® XC Product Overview

Contact blocks (continued)

XE2•P screw clamp terminal connections

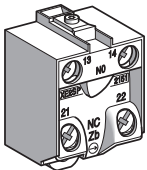

XE3•P screw clamp terminal connections

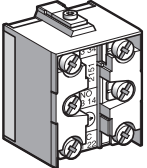

Mounting

Contact connections

- Tightening torque:
 - minimum tightening torque ensuring the nominal characteristics of the contact: 0.8 N•m (7.08 lb-in)
 - maximum tightening torque without damage to the terminals: 1.2 N•m (10.62 lb-in) for XE2•P, 1 N•m (8.85 lb-in) for XE3•P
- Connecting cable: cable preparation lengths:
 - for XE2•P, L = 22 mm (0.87 in.)
 - for XE2•P3••, L = 45 mm (1.77 in.)
 - for XE3•P:
 - L = 14 mm (0.55 in.)
 - L1 = 11 mm (0.43 in.)

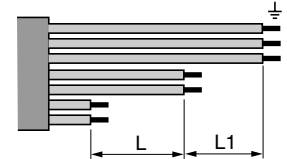
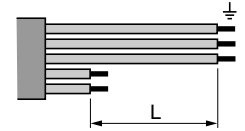

Sweep of connecting cable

1. Recommended
2. To be avoided

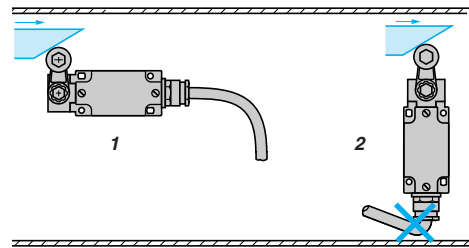

Position of cable entry

1. Recommended
2. To be avoided

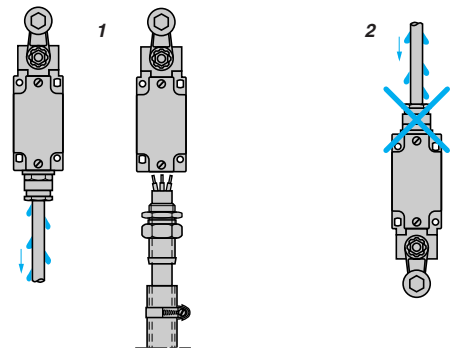

Type of cam

1. Recommended
2. To be avoided

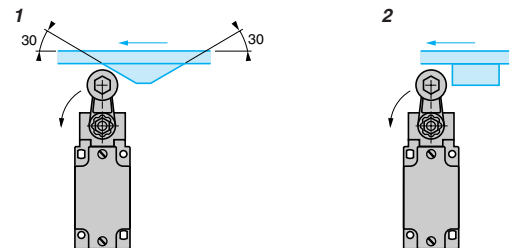

Mounting limit switches by the head

1. Recommended
2. Forbidden

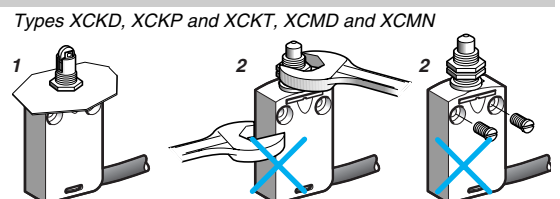

Types XCKD, XCKP and XCKT, XCMD and XCMN

Limit Switches

Selection Guide

Osiswitch® XC Product Overview

Setup

Tightening torque

- The minimum torque is that required to ensure correct operation of the switch.
- The maximum torque is the value which, if exceeded, will damage the switch.

Range	Item	Torque, N•m (lb-in)	
		Min.	Max.
Compact design XCKD, XCKP, XCKT	Cover	0.8 (7.08)	1.2 (10.62)
	Mounting screw for lever on rotary head	1 (8.85)	1.5 (13.28)
Miniature design XCMD, XCMN	—	—	—
	Mounting screw for lever on rotary head	1 (8.85)	1.5 (13.28)
Classic design XCKJ	Cover	1 (8.85)	1.5 (13.28)
	Mounting nut for lever on rotary head	1 (8.85)	1.5 (13.28)
Classic design XCKS	Cover	0.8 (7.08)	1.2 (10.62)
	Mounting nut for lever on rotary head	1 (8.85)	1.5 (13.28)
Classic design XCKM, XCKML, XCKL	Cover	0.8 (7.08)	1.2 (10.62)
	Mounting nut for lever on rotary head	1 (8.85)	1.5 (13.28)

Types XCKD, XCKP, XCKT, XCMD

- Adjustable in 3 planes:

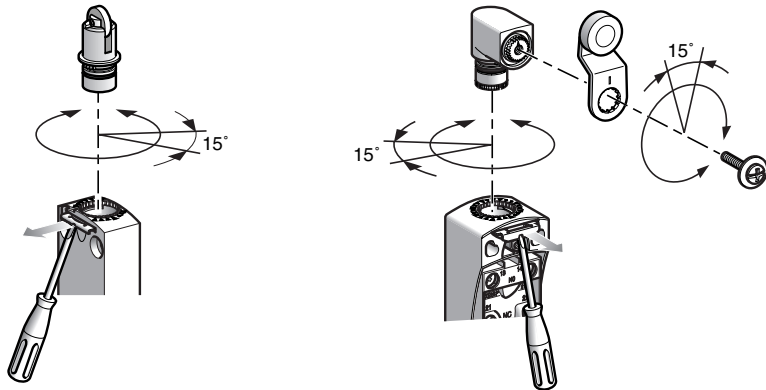

All the heads can be adjusted in 15° steps throughout 360°, in relation to the body. All the levers can be adjusted in 15° steps throughout 360°, in relation to the horizontal axis of the head.

Type XCKJ

- Adjustable through 360° in 5° steps, or in 45° steps by reversing the lever or its mounting.
 1. Reversed $\alpha = 5^\circ$
 2. Forward $\alpha = 45^\circ$

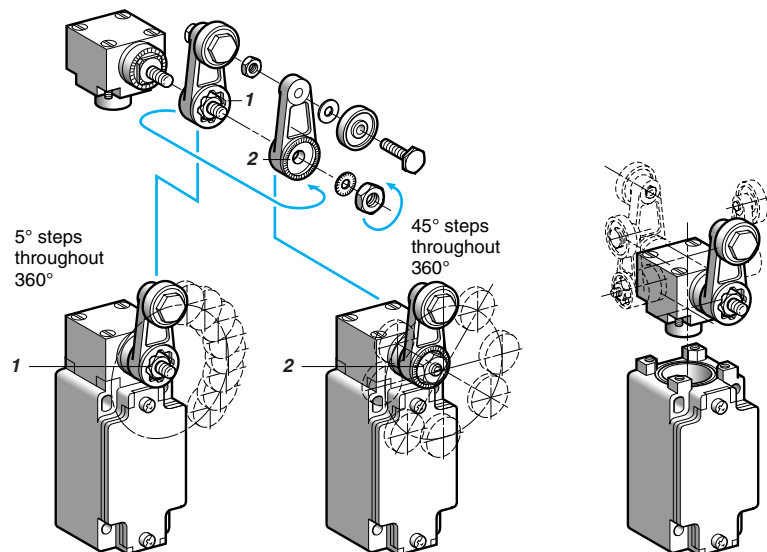

Limit Switches

Selection Guide

Osiswitch® XC Product Overview

Setup (continued)

Direction of actuation programming

- XCKJ

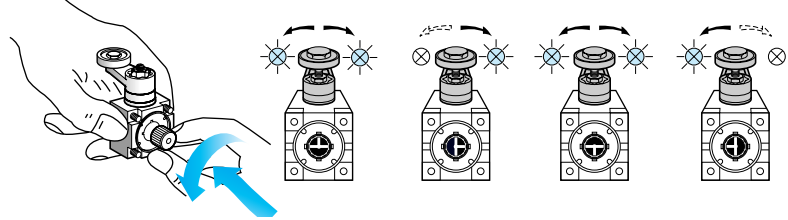

Head ZCKE05

- XCKS

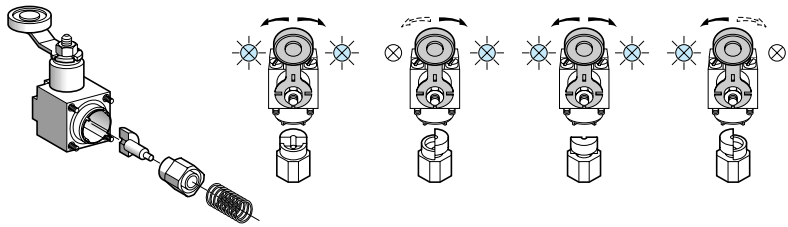

Head ZCKD05

- XCKD, XCKP, XCKT and XCMD

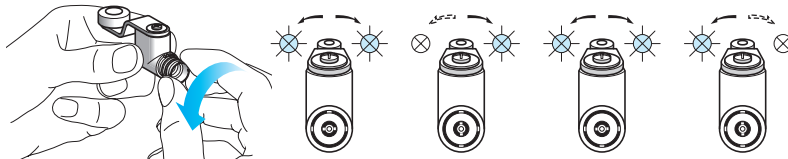

Head ZCE05

Specific cams for heads ZCKE09 and ZC2J09

1. 0.5 mm (0.02 in.) min.
2. 2 mm (0.08 in.) min.

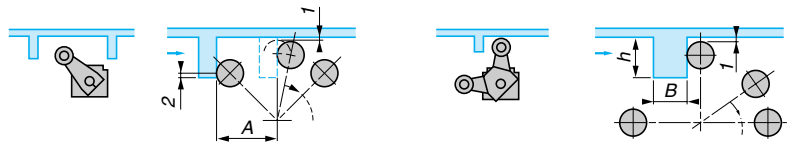

A = length of lever + 11 mm (0.43 in.)

ZCKE09: h = 13–18 mm (0.51–0.71 in.) and B = 12 mm (0.47 in.) max.

ZCKJE09: h = 14–24 mm (0.55–0.94 in.) and B = 6 mm (0.24 in.) max.

ZCKG00 Head Programming

The ZCKG00 head is field convertible to CW, CCW or CW/CCW. The diagram below shows the conversion process.

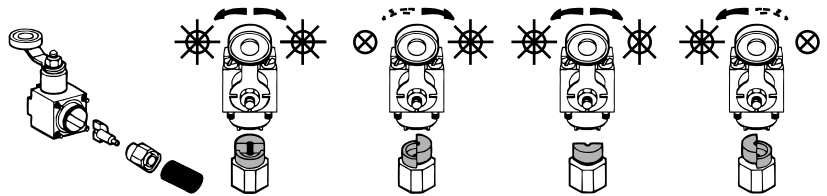

Limit Switches

Selection Guide





Osiswitch® XC Product Overview

Compliance with standards

The majority of Telemecanique® brand products comply to national standards (such as French NF C standards, German DIN standards), European standards (such as CENELEC), or international standards (such as IEC). These standards rigidly stipulate the characteristic requirements of the designated products (for example IEC 60947 relating to low voltage switchgear and controlgear).

These products, when correctly used, enable the production of control equipment assemblies, machine control equipment or installations conforming to their own specific standards (for example IEC 60204 for the electrical equipment of industrial machines).

IEC 60947-5-1

Insulation coordination (and dielectric strength)	<ul style="list-style-type: none"> The standard IEC 60664 defines 4 categories of prospective transient overvoltages. It is important for the user to select control circuit components which are able to withstand these overvoltages. To these ends, the manufacturer states the rated impulse withstand voltage (U_{imp}) applicable to the product. 	
Terminal connections	<ul style="list-style-type: none"> The cabling capacity, mechanical robustness and durability of the terminals, as well as the ability to resist loosening, are verified by standardized tests. Terminal reference marking conforms to standard EN 50013. 	
Switching capacity	<ul style="list-style-type: none"> With maximum electrical load. A single designation (A300 for example) enables indication of the contact block characteristics related to its utilization category. 	
Positive opening operation (IEC 60947-5-1 Appendix K)	<ul style="list-style-type: none"> For contacts used in safety applications (end of travel, emergency stop device, etc.) the assurance of positive opening is required (see IEC 60204, EN 60204) after each test, the opening of the contact being verified by testing with an impulse voltage (2500 V). 	
Electrical symbols for contacts	 <ul style="list-style-type: none"> Form Za, the 2 contacts are the same polarity. 	 <ul style="list-style-type: none"> Form Zb, the 2 contacts are electrically separate.
Symbol for positive opening	 <ul style="list-style-type: none"> Simplified version 	 <ul style="list-style-type: none"> Complete symbol

CENELEC EN 50047

The European standards organization CENELEC, which has 14 member countries, has defined in this standard the first type of limit switch.

This standard defines 4 variants of devices (forms A, B, C, E).

Limit switches XCKP, XCKD and XCKT conform to standard EN 50047.

Form A, with roller lever

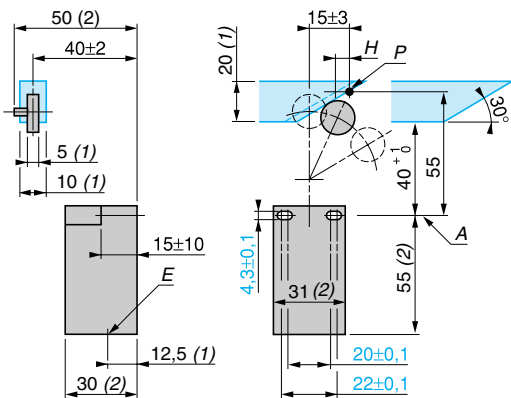

Form B, with end plunger (rounded)

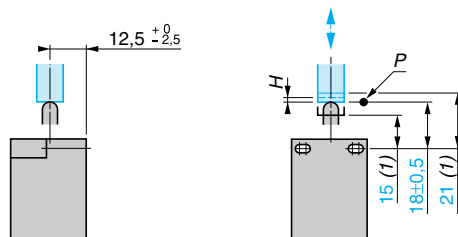

1. Minimum value
2. Maximum value

A: reference axis
H: differential travel

P: tripping point
E: cable entry

Form C, with end roller plunger

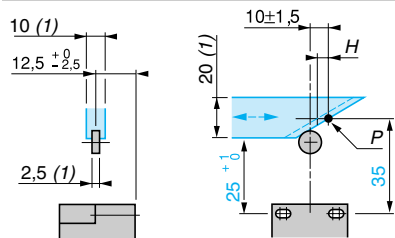

Form E, with roller lever for 1 direction of actuation

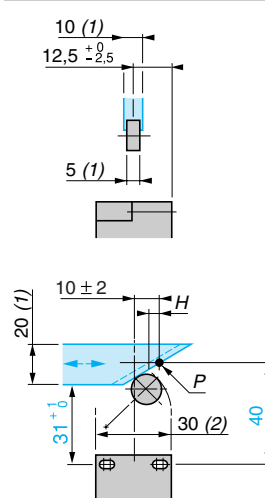

Limit Switches

Selection Guide

Osiswitch® XC Product Overview

Compliance with standards (continued)

CENELEC EN 50041

The European standards organization CENELEC, which has 14 member countries, has defined in this standard the second type of limit switch.

It defines 6 variants of devices (forms A, B, C, D, F, G).

Limit switches XCKJ and XCKS conform to standard EN 50041.

Form A, with roller lever

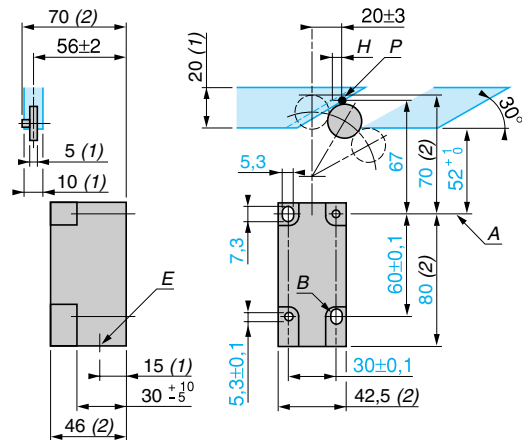

Form B, with end plunger (rounded)

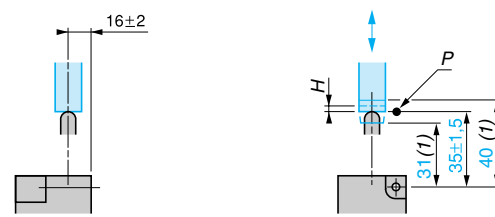

1. Minimum value
2. Maximum value

A: reference axis
 B: optional elongated holes
 H: differential travel
 P: tripping point
 E: cable entry
 Za: tripping zone
 Sa: tripping threshold

Form C, with end roller plunger

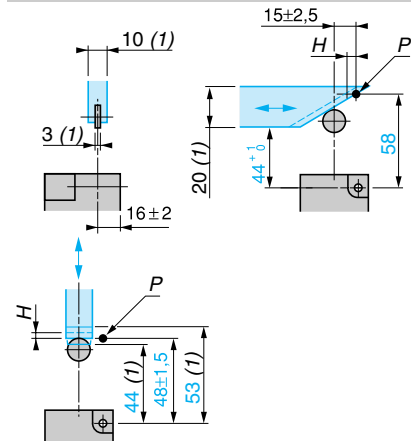

Form D, with rod lever

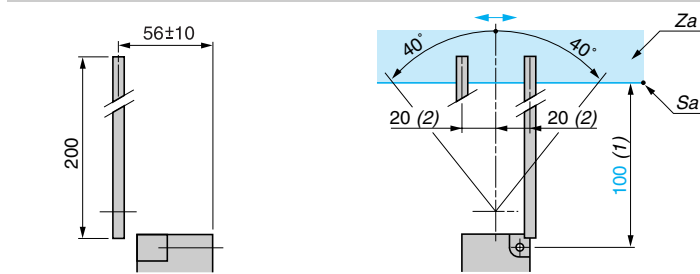

Form F, with side plunger (rounded)

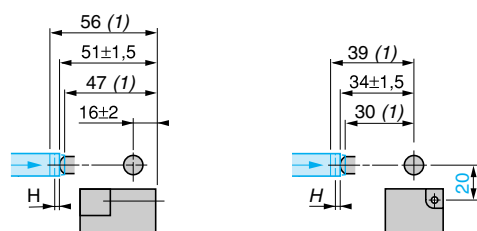

Form G, with side roller plunger

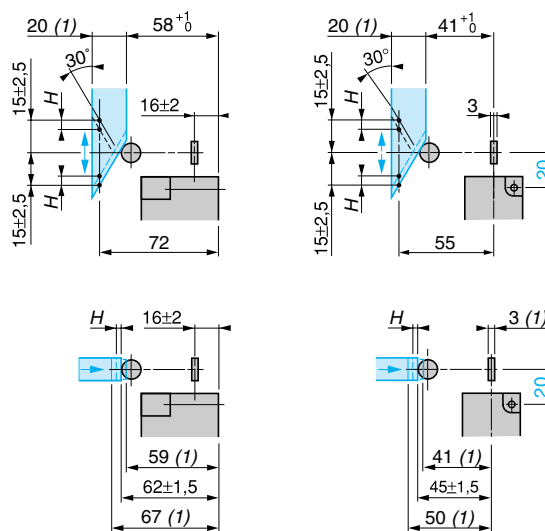

Limit Switches

Osiswitch® Miniature Snap Switches

XEP and XC0

Introduction

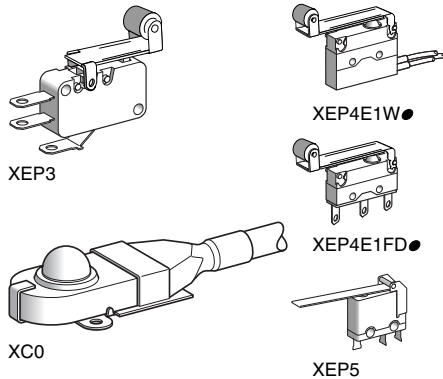

Electromechanical detection

Osiswitch miniature snap switches, featuring electromechanical technology, assure the following functions:

- detection of presence or absence
- detection of position.

Actuation of the operator (plunger or lever) on the miniature snap switch causes the electrical contact to change state. This information can then be processed by a PLC controlling the installation.

Osiswitch miniature snap switches can be used both for industrial applications and the building sector.

Features

Osiswitch miniature snap switches incorporate a C/O snap-action, single-break contact. They are characterized by:

- high electrical ratings for their very small size
- short tripping travel
- low tripping force
- high repeat accuracy on the tripping points
- long service life

Terminology

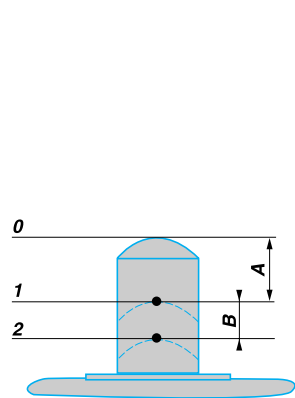

Forces

Maximum tripping force: maximum force which must be applied to the operator to move it from the rest (unactuated) position to the trip position (tripping point).

Minimum release force: value to which the force on the operator must be reduced to allow the snap action mechanism to return to its rest (unactuated) position.

Maximum permissible end of travel force: maximum force that can be applied to the operator at the end of its travel without damaging the switch.

Position / Travel

1. Tripping point: position of the operator in relation to the switch mountings (mounting hole center line) at the instant the switch contact changes state.
 - A. Differential travel: distance between the tripping point and the position at which the snap action mechanism returns to its initial state on release of the operator.
2. Overtravel limit: position of the operator when an extreme force has moved it to the effective end of its available travel.
 - B. Overtravel: distance between the tripping point and the overtravel limit.

The reference point for the figures given for forces and travel is a point F, which is situated on the plunger in the case of a basic switch or at 3 mm (0.12 in.) from the end of the plain lever in the case of a lever operated switch.

Mechanical characteristics

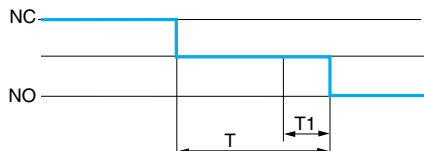

T1: bounce time
T: changeover time

Changeover time

This is the time taken by the moving contact when moving from one fixed contact to another until it becomes fully stable (contact bounce included).

This time is related to the inter-contact distance, the mechanical characteristics of the snap action mechanism, and the mass of the moving element. However, due to the snap action mechanisms used, the time is largely independent of the speed of operation. It is normally less than 20 ms (including bounce times of less than 5 ms).

Operating speed and maximum usable operating rate

Our miniature snap switches are suitable for a wide range of operating speeds: generally, from 1 mm/mn to 1 m/s (0.04 in/mn to 3.28 ft/s). The maximum usable operating rate on a light electrical load may be as high as 10 operations/second.

Mounting

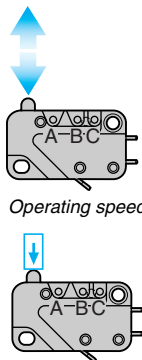

Operating speed and rate

Mounting and operation

To conform to the leakage paths and air gaps in standards EEC 24 - EN/IEC 61058 and EN/IEC 60947:

- an insulation pad must be inserted between the snap switch and the mounting surface if the latter is metal,
- manual operation of a metal actuator must only be carried out with the aid of an intermediate actuator made of an insulating material.
- The installer must ensure adequate protection against direct contact with the output terminals.

Actuation method

Direct operation: The plunger should preferably be actuated along its axis. However, the majority of our miniature snap switches will accept skewed operation provided the angle of actuation is not more than 45°.

The travel of the actuator must not be limited to only reaching the tripping point. The actuator must always be operated in such a manner that the plunger reaches a point at least 0.5 times the stated overtravel value of the switch. Also, it should not reach its end of travel nor exceed the maximum permissible end-of-travel force.

Limit Switches

Osiswitch® Miniature Snap Switches

XEP and XC0

Mounting (continued)

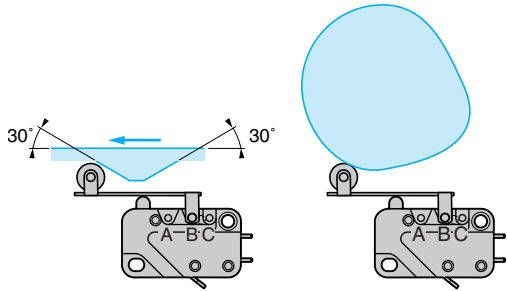

Actuation method (continued)

Lever operators:

- when actuation is by a roller lever, force should preferably be applied in the direction shown in the diagrams opposite,
- where the movements involved are fast, the ramp should be so designed as to ensure that the operator is not subjected to any violent impact or abrupt release.

Mounting—Tightening torque

The tightening torque of the fixing screws must conform to the following values:

Ø of mounting screw		2	2.5	3	3.5	4
Tightening torque, N•cm (lb-in)	Maximum	25 (2.21)	35 (3.10)	60 (5.31)	100 (8.85)	150 (13.28)
	Minimum	15 (1.33)	25 (2.21)	40 (3.54)	60 (5.31)	100 (8.85)

Resistance to mechanical shock and vibration

- Resistance to shock and vibration depends on the mass of the moving parts and on the forces holding the contacts together.
- In general, for a miniature snap switch without accessory:
 - vibration > 10 gn, 10 to 500 Hz
 - shock > 50 gn 11 ms 1/2 sine wave

Electrical characteristics

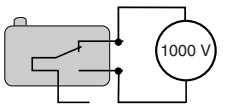
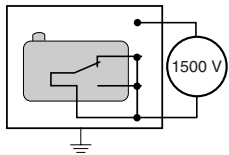
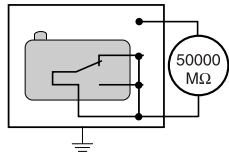
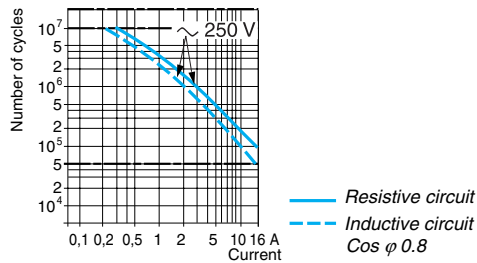

Operating curves

These indicate the electrical life of the miniature snap switches under standard conditions [20°C (68 °F), 1 cycle/2 seconds], by showing the number of switching operations which can be performed with given types of load. For sealed snap switches, the operating rate is 1 cycle/6 s.

Insulation resistance

The insulation resistance of the miniature snap switches is generally greater than 50,000 MΩ, measured at 500 Vdc

Dielectric strength

The dielectric strength of our miniature snap switches is generally superior to:

- 1500 V between live parts and earth
- 1000 V between contacts
- 600 V between contacts for switches with an inter-contact distance less than 0.3 mm

Limit Switches

Osiswitch® Miniature Snap Switches

Subminiature (DIN 41635 B format, sealed) and Sub-subminiature (DIN 41635 D format)

Catalog numbers

Subminiature design, DIN 41635 B format, sealed

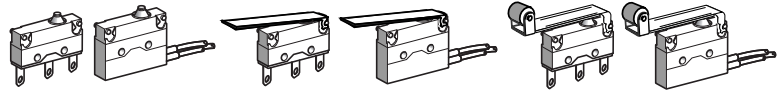

Type of operator	Plunger	Flat lever (1)	Roller lever (1)
<p>Single-pole C/O snap action Wiring: 1 Black 2 Grey 4 Blue</p>	2.8 mm (0.11 in.) cable clip tag connections XEP4E1W7 (3)	XEP4E1W7A326 (3)	XEP4E1W7A454 (3)
	Weight, g (oz) 2.4 (0.08)	3.1 (0.11)	3.2 (0.11)
	Pre-cabled connections XEP4E1FD (3)	XEP4E1FDA326 (3)	XEP4E1FDA454 (3)
Separate components	Flat lever (2) ZEP4L326 (3)	—	—
	Weight, g (oz) 0.7 (0.02)	—	—
	Roller lever (2) ZEP4L454 (3)	—	—
	Weight, g (oz) 0.8 (0.03)	—	—

Sub-subminiature design, DIN 41635D format



Type of operator	Plunger	Flat lever (1)
<p>Single-pole C/O snap action</p>	Solder tag connections XEP5P1W2 (3)	XEP5P1W2Z55B (3)
	Weight, g (oz) 1.4 (0.05)	1.9 (0.07)

Dimensions

XEP4E1W7

XEP4E1W7A326

XEP4E1W7A454

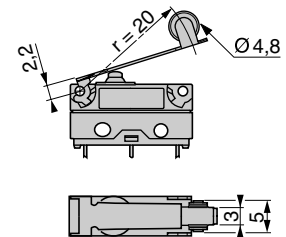
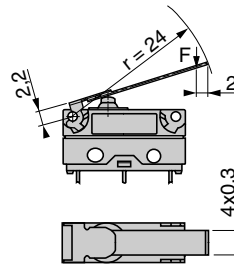
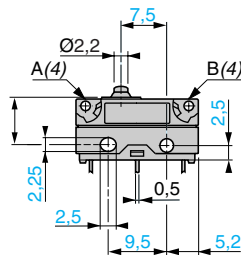
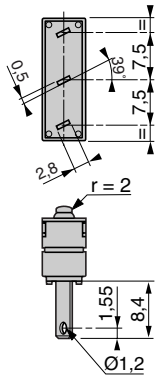

XEP4E1FD

XEP4E1FDA326

XEP4E1FDA454

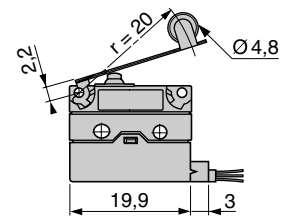
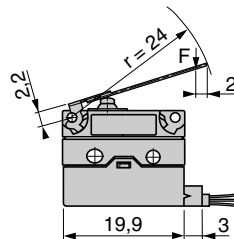
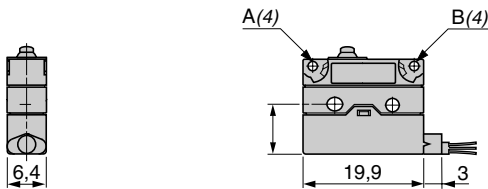

XEP5P1W2

XEP5P1W2Z55B

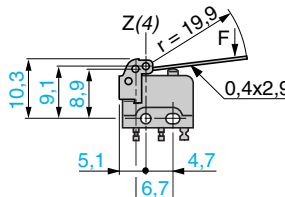
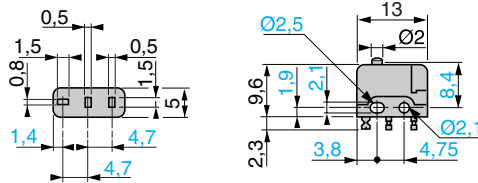

1. To avoid damage to the mounting spigots, removal of the lever from complete products is not recommended.
2. Levers only for mounting on basic (plunger) snap switches (XEP4E1W7 and XEP4E1FD).

3. Switches sold in lots of 5.
4. A, B, Z: lever fixing positions.

Limit Switches

Osiswitch® Miniature Snap Switches

Subminiature (DIN 41635 B format, sealed) and Sub-subminiature (DIN 41635 D format)

Switch type	XEP4E1**, XEP5P1W2 Plunger	XEP4E1**A326, XEP5P1W2Z55B Flat lever	XEP4E1**A454 Roller lever
Environmental characteristics			
Lever fixing position (1)	—	A	A
Switch actuation	On end	Horizontal	
Product certifications	CE, IEC 60947-5-1, EN 60947-5-1, c UR us, UL 1054, EN 61058		
Degree of protection	IP 67 XEP4E1FD**, case IP 67 and tags IP 00 XEP4E1W7**, case IP 40 and tags IP 00 XEP5P1W2**		
Operating temperature	- 40...+ 105 °C XEP4E1FD**, -40...+125 °C XEP4E1W**** and XEP5P1**		
Materials	Enclosure	Polyester XEP4, diallyl-phtalate XEP5	
	Lever	—	Stainless steel
	Contact	AgCdO XEP4E1**, Ag XEP5	
	Tags	Tinned brass XEP4E1W**, gold plated brass XEP5P1**	

		Lever fixing position (1)	XEP4	XEP5
Maximum tripping force, N (oz)	XEP4	A	2.5 N (8.99 oz)	0.63 N (2.27 oz)
		B	2.5 N (8.99 oz)	1.25 N (4.50 oz)
	XEP5		2 N (7.19 oz)	0.80 N (2.88 oz)
Minimum release force, N (oz)	XEP4	A	0.80 N (2.88 oz)	0.20 N (0.72 oz)
		B	0.80 N (2.88 oz)	0.40 N (1.44 oz)
	XEP5		0.40 N (1.44 oz)	0.15 N (0.54 oz)
Maximum permissible end of travel force, N (lb)	XEP4	A	10 N (2.25 lb)	2.5 N (0.56 lb)
		B	10 N (2.25 lb)	5 N (1.12 lb)
	XEP5		10 N (2.25 lb)	—
Tripping point (TP) (2)	XEP4	A	8.40 +/- 0.3 mm	10.7 +/- 1.7 mm
		B	8.40 +/- 0.3 mm	9.6 +/- 1.0 mm
	XEP5		8.40 mm	9.20 mm
Maximum differential travel	XEP4	A	0.13 mm	0.52 mm
		B	0.13 mm	0.26 mm
	XEP5		0.06 mm	0.25 mm
Minimum overtravel	XEP4	A	0.60 mm	2.40 mm
		B	0.60 mm	1.20 mm
	XEP5		0.10 mm	—
Inter-contact distance	XEP4		0.4 mm	
		XEP5		0.3 mm
Mechanical durability	XEP4		2 million operating cycles	
		XEP5		0.1 million operating cycles

		XEP4	XEP5
Electrical characteristics			
Operational characteristics	XEP4	AC-15: B300 (Ue: 240 V, Ie: 1.5 A) DC-13: R300 (Ue: 250 V, Ie: 0.1 A) conforming to IEC 60947-5-1, EN 60947-5-1 Appendix A 125-250 Vac 6.0 A conforming to UL 1054 6 (1) A 250 Vac 10,000 cycles conforming to EN 61058	
	XEP5	AC-15: D300 (Ue: 240 V, Ie: 0.3 A) conforming to IEC 60947-5-1, EN 60947-5-1 Appendix A	
Thermal current	XEP4	7.5 A on 250 V (50/60 Hz)	
	XEP5	8.5 A on 250 V (50/60 Hz)	
Connection	XEP4	XEP4E1W7*: 2.8 mm (0.11 in.) cable clip tags XEP4E1FD: Pre-cabled (horizontally in-line), 3 x 0.5 mm ² , length 0.5 m (1.6 ft)	
	XEP5	Solder tags	

Operating curves

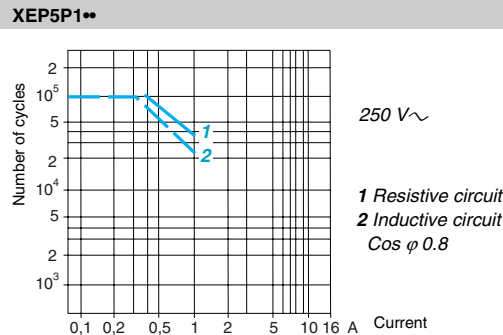
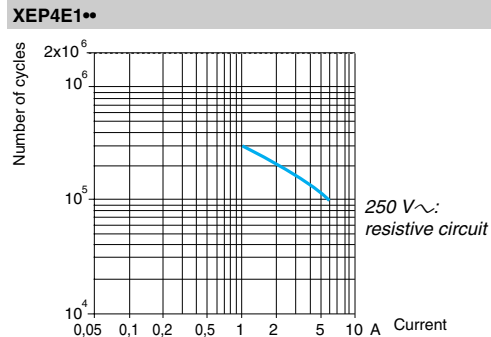

- Miniature snap switches fitted with a lever are supplied with the lever fixed in position A (see page 26).
For basic (plunger) snap switches, it is possible to fix a lever in position A or B, depending on the required tripping conditions (see page 26).
- Position of the operator in relation to the switch mountings (mounting hole center line), at the instant the contact changes state.

Limit Switches

Osiswitch® Miniature Snap Switches

Miniature (DIN 41635 A format)

Catalog numbers

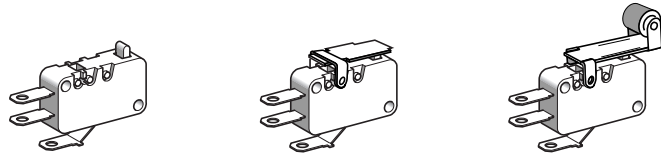

Type of operator		Plunger (2)	Flat lever (1) (2)	Roller lever (1) (2)	
Single-pole C/O snap action	Standard contacts	Solder tags	XEP3S1W2	XEP3S1W2B524	
		4.8 mm (0.19 in.) cable clip tags	XEP3S1W6	XEP3S1W6B524	
		6.35 mm (0.25 in.) cable clip tags	XEP3S1W3	XEP3S1W3B524	
		Weight, g (oz)	5.6 (0.20)	6.3 (0.22)	6.6 (0.23)
	Very low operating force contacts	Solder tags	XEP3S2W2	XEP3S2W2B524	XEP3S2W2B529
		4.8 mm (0.19 in.) cable clip tags	XEP3S2W6	XEP3S2W6B524	XEP3S2W6B529
6.35 mm (0.25 in.) cable clip tags		XEP3S2W3	XEP3S2W3B524	XEP3S2W3B529	
	Weight, g (oz)	5.6 (0.20)	6.3 (0.22)	6.6 (0.23)	
Flat lever (3)		ZEP3L524			
		Weight, g (oz)			
Separate components		ZEP3L529			
Roller lever (3)		Weight, g (oz)			
		1 (0.04)			

Dimensions

XEP3S•W2

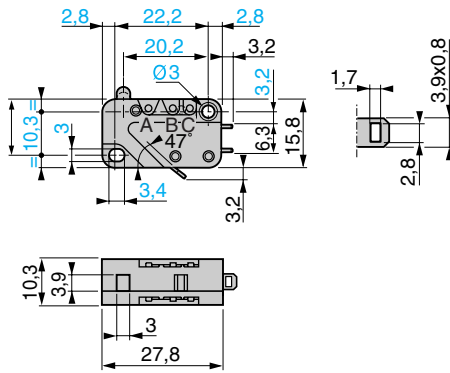

XEP3S•W6

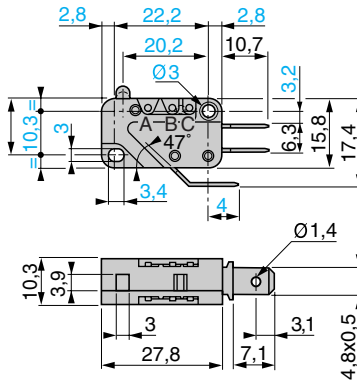

XEP3S•W3

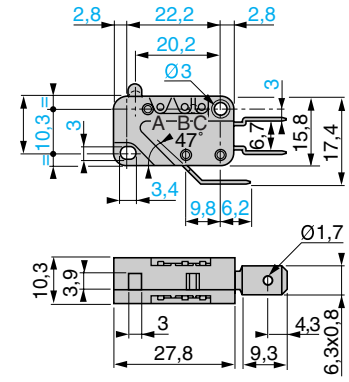

ZEP3L529

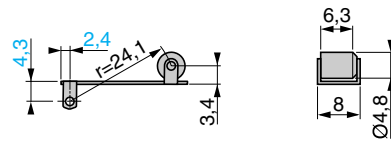

ZEP3L524

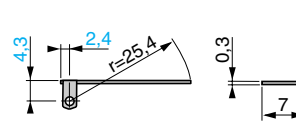

- To avoid damage to the mounting spigots, removal of the lever from complete products is not recommended.
- Switches sold in lots of 10.
- Levers only for mounting on basic (plunger) snap switches (XEP3S•W2, XEP3S•W3 and XEP3S•W6), in mounting positions A, B or C.

Limit Switches

Osiswitch® Miniature Snap Switches

Miniature (DIN 41635 A format)

Switch type	XEP3 S•W2		XEP3 S•W2B254	XEP3 S•W2B259
Type of operator	Plunger		Flat lever	Roller lever
Environmental characteristics				
Lever fixing position (1)	—		B	B
Switch actuation	On end		Horizontal	
Product certifications	--- UR us, CE, IEC/EN 60947-5-1, UL 1054, EN 61058-1			
Degree of protection	Case IP 40 and tags IP 00			
Operating temperature	- 25...+ 125 °C			
Materials	Enclosure	Polyester		
	Lever	—	Stainless steel	Stainless steel, glass reinforced polyamide roller
	Contact	AgNi		

Mechanical characteristics					
Lever fixing position (1)					
Maximum tripping force, N (oz)	Standard	A	0.80 N (2.88 oz)	0.20 N (0.72 oz)	
		B	0.80 N (2.88 oz)	0.40 N (1.44 oz)	
		C	0.80 N (2.88 oz)	0.53 N (1.91 oz)	
	Very low force	A	0.25 N (0.90 oz)	0.06 N (0.22 oz)	
		B	0.25 N (0.90 oz)	0.13 N (0.47 oz)	
		C	0.25 N (0.90 oz)	0.17 N (0.61 oz)	
Minimum release force, N (oz)	Standard	A	0.20 N (0.72 oz)	0.05 N (0.18 oz)	
		B	0.20 N (0.72 oz)	0.10 N (0.36 oz)	
		C	0.20 N (0.72 oz)	0.13 N (0.47 oz)	
	Very low force	A	0.05 N (0.18 oz)	0.01 N (0.04 oz)	
		B	0.05 N (0.18 oz)	0.03 N (0.11 oz)	
		C	0.05 N (0.18 oz)	0.03 N (0.11 oz)	
Maximum permissible end of travel force, N (lb)	Standard, very low force	A	20 N (4.50 lb)	5 N (1.12 lb)	
		B	20 N (4.50 lb)	10 N (2.25 lb)	
		C	20 N (4.50 lb)	13 N (2.92 lb)	
Tripping point (TP) (2)	Standard, very low force	A	14.70 ^{+/-0.4} mm	15.20 ^{+/-2.5} mm	20.5 ^{+/-2.9} mm
		B	14.70 ^{+/-0.4} mm	15.20 ^{+/-1.0} mm	20.5 ^{+/-1.5} mm
		C	14.70 ^{+/-0.4} mm	15.20 ^{+/-0.8} mm	20.5 ^{+/-1.2} mm
Maximum differential travel	Standard, very low force	A	0.35 mm	1.40 mm	
		B	0.35 mm	0.70 mm	
		C	0.35 mm	0.53 mm	
Minimum overtravel	Standard	A	1.20 mm	4.80 mm	
		B	1.20 mm	2.40 mm	
		C	1.20 mm	1.80 mm	
	Very low force	A	1.10 mm	4.40 mm	
		B	1.10 mm	2.20 mm	
		C	1.10 mm	1.65 mm	
Inter-contact distance	0.40 mm				
Mechanical durability for 2/3 overtravel	Standard	20 million operating cycles			
	Very low force	50 million operating cycles			

Electrical characteristics				
Operational characteristics	Standard	AC-15: B300 (Ue: 240 V, Ie: 1.5 A) DC-13: R300 (Ue: 250 V, Ie: 0.1 A) conforming to IEC/EN 60947-5-1 Appendix A 125-250 Vac 10.1 A—1/2 HP conforming to UL 1054 12 (3) A 250 Vac 10,000 cycles conforming to EN 61058-1		
	Very low force	AC-15: D300 (Ue: 240 V, Ie: 0.3 A) conforming to IEC/EN 60947-5-1 Appendix A 125-250 Vac 4 A—1/10 HP conforming to UL 1054 4 (1) A 250 Vac 50,000 cycles conforming to EN 61058-1		
Thermal current	Standard	15 A on 250 V (50/60 Hz)		
	Very low force	5 A on 250 V (50/60 Hz)		
Connection	XEP3 S•W2 : solder tags. XEP3 S•W6 : 4.8 mm (0.19 in.) cable clip tags XEP3 S•W3 : 6.35 mm (0.25 in.) cable clip tags.			

Operating curves

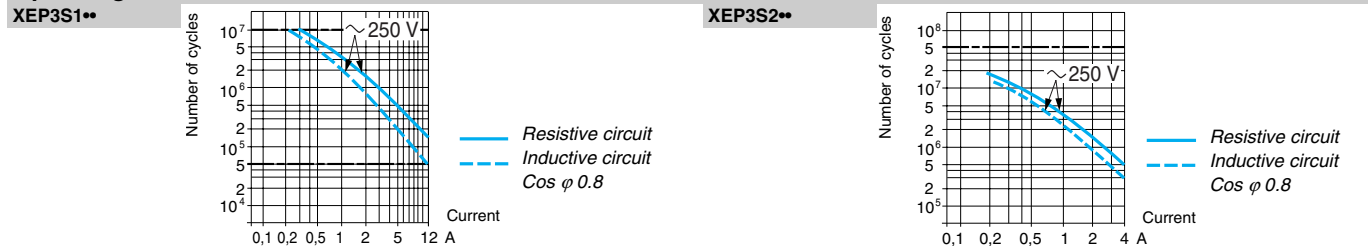

- Miniature snap switches fitted with a lever are supplied with the lever fixed in position B (see page 28). For basic (plunger) snap switches, it is possible to fix a lever in position A, B or C, depending on the required tripping conditions (see page 28).
- Position of the operator in relation to the switch mountings (mounting hole center line), at the instant the contact changes state.

Limit Switches

Osiswitch® Miniature Snap Switches

Sealed Design Pre-Cabled

Type of head Plunger (mounting by the body)

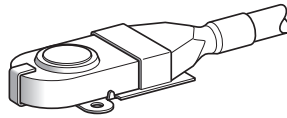

Head with flat plunger

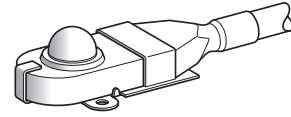

Head with domed encased plunger

Type of operator

Catalog numbers

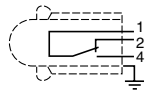

Single-pole C/O snap action
Wiring:
1 Black
2 Brown
4 Blue

XC010L2

XC011L2

Weight, kg (lb)

0.145 (0.320)

0.150 (0.331)

Dimensions

XC010L2

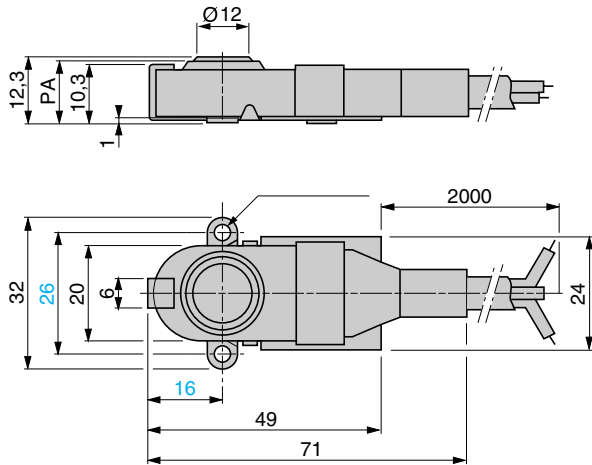

XC011L2

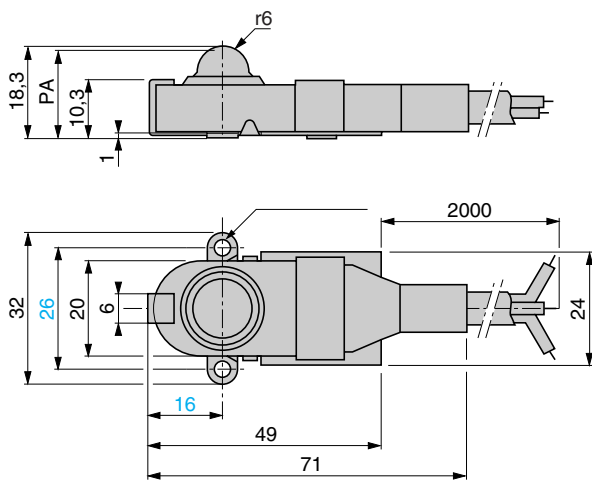

Limit Switches

Osiswitch® Miniature Snap Switches

Sealed Design Pre-Cabled

Switch type	XC010•	XC011•
Environmental characteristics		
Switch actuation	On end, flat plunger (1)	On end, domed plunger (1)
Product certifications	CE, IEC 60947-5-1	
Degree of protection	IP 66	
Operating temperature	0...85 °C (32...185 °F)	
Materials	Internal housing	Metal
	Casing	Nitrile
	Mounting support	Steel, zinc passivated
	Contact	Ag
Mechanical characteristics		
Maximum tripping force	5.3 N (1.19 lb)	
Minimum release force	1.5 N (0.34 lb)	
Maximum permissible end of travel force	30 N (6.74 lb)	
Tripping point (TP) (2)	11.4 ^{±0.4} mm	17.4 ^{±0.5} mm
Maximum differential travel	0.2 mm	
Minimum overtravel	0.2 mm	
Inter-contact distance	0.5 mm	
Mechanical durability	2 million operating cycles	
Electrical characteristics		
Operational current	1 A on 24 V (50/60 Hz)	
Thermal current/insulation voltage	12 A/60 V	
Connection	A05 VVF cable, 3 x 0.75 mm ² , length 2 m (6.6 ft), overall diameter ≤ 7.6 mm (0.30 in.)	
Electrical durability	AC-15: 0.5 million operating cycles	

Operating curve

- Manual actuation must be made by an intermediate insulated part, in order to meet basic safety requirements. One of the two mounting holes must also be used as an earth protection terminal.
- Distance between the base of the switch and the top of the plunger at the instant the contact changes state (see dimensions, page 30).

Limit Switches

Osiswitch® Miniature, Metal

Universal, XCMD

■ XCM D
pre-cabled

□ With head for linear movement (plunger). Mounting by the body.

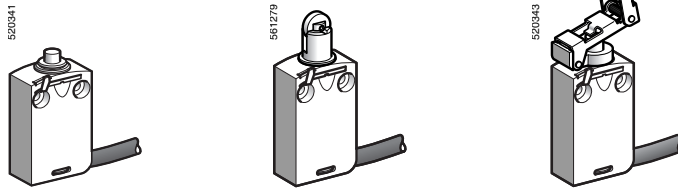

Page 34

□ With head for linear movement (plunger). Mounting by the head.

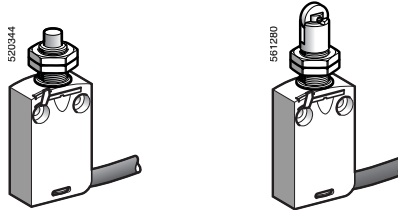

Page 34

□ With head for rotary movement (lever) or multi-directional. Mounting by the body.

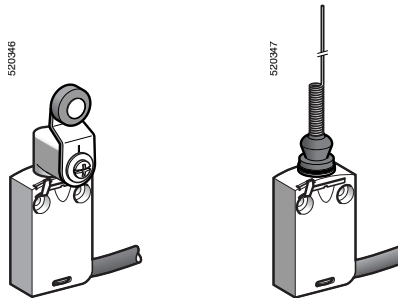

Page 35

■ XCM D
with integral connector

□ With head for linear movement (plunger)
Mounting by the body

Mounting by the head

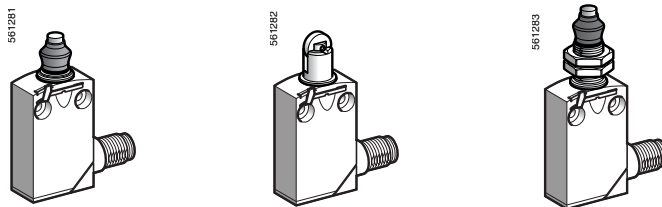

Page 38

□ With head for rotary movement (lever) or multi-directional. Mounting by the body.

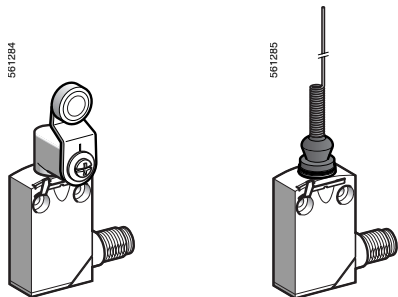

Page 39

Limit Switches

Osiswitch® Miniature, Metal

Universal, XCMD

Environmental characteristics																																						
Conforming to standards	Products	IEC 60947-5-1, EN 60947-5-1, UL 508, CSA C22-2 n° 14																																				
	Machine assemblies	IEC 60204-1, EN 60204-1																																				
Product certifications		UL, CSA (except products with special cables), CCC																																				
Protective treatment		Standard version: "TC"																																				
Ambient air temperature		Operation: -25...+70 °C (-13...+158 °F). Storage: -40...+70 °C (-40...+158 °F)																																				
Vibration resistance		XCMD snap action: 5 gn. XCMD slow break: 25 gn (10...500 Hz) conforming to IEC 60068-2-6																																				
Shock resistance		25 gn (18 ms) conforming to IEC 60068-2-27																																				
Electric shock protection		Class I conforming to IEC 61-140 and NF C 20-030																																				
Degree of protection		NEMA Types 1, 2, 4, 12, 13 IP 66, IP 67 and IP 68 (1) conforming to IEC 60529 IK 06 conforming to EN 50102																																				
Materials		Bodies and heads: Zamak® zinc alloy																																				
Repeat accuracy		0.05 mm on the tripping points, with 1 million operating cycles for head with end plunger																																				
Protection against prolonged immersion: the test conditions are subject to agreement between the manufacturer and the user.																																						
Contact block characteristics																																						
Rated operational characteristics	Switches with 2 contacts	~ AC-15; B300 (Ue = 240 V, Ie = 1.5 A) = DC-13; R300 (Ue = 250 V, Ie = 0.1 A), conforming to IEC 60947-5-1 Appendix A, EN 60947-5-1																																				
	Switches with 3 and 4 contacts	~ AC-15; C300 (Ue = 240 V, Ie = 0.75 A) = DC-13; R300 (Ue = 250 V, Ie = 0.1 A), conforming to IEC 60947-5-1 Appendix A, EN 60947-5-1																																				
	Pre-cabled switches	Ithe = 6 A for 2 contacts, 4 A for 3 contacts, 3 A for 4 contacts																																				
	Switches with 4-pin M12 connector	Ui = 250 V, Ie = 3 A maximum, Ithe = 3 A																																				
	Switches with 5-pin M12 connector	Ui = 60 V, Ie = 4 A maximum, Ithe = 4 A																																				
	Switches with 5-pin 7/8" 16UN connector	Ui = 250 V, Ie = 6 A maximum, Ithe = 6 A																																				
Rated insulation voltage		Ui = 400 V degree of pollution 3 conforming to IEC 60947-5-1 Ui = 300 V conforming to UL 508, CSA C22-2 n° 14																																				
Rated impulse withstand voltage		U imp = 4 kV conforming to IEC 60947-1, IEC 60664																																				
Positive operation (depending on model)		N/C contacts with positive opening operation conforming to IEC 60947-5-1 Appendix K, EN 60947-5-1																																				
Resistance across terminals		≤ 25 mΩ conforming to IEC 60255-7 category 3																																				
Electric shock protection		6 A cartridge fuse type gG (gl)																																				
Minimum actuation speed		Snap action contact: 0.01 m/minute (0.03 ft/minute) Slow break contact: 6 m/minute (19.68 ft/minute)																																				
Electrical durability		<ul style="list-style-type: none"> Conforming to IEC 60947-5-1 Appendix C Utilization categories AC-15 and DC-13 Maximum operating rate: 3600 operating cycles/hour Load factor: 0.5 																																				
		<table border="0"> <tr> <td style="vertical-align: top;"> <p>a.c. supply ~ 50/60 Hz mm inductive circuit</p> </td> <td style="vertical-align: top;"> <p>XCMD snap action (N/C + N/O, N/C + N/C, N/C + N/C + N/O, N/C + N/C + N/O + N/O contacts)</p> </td> <td style="vertical-align: top;"> <p>XCMD slow break (N/C + N/O, N/C + N/C + N/O contacts)</p> </td> </tr> <tr> <td style="vertical-align: top;"> <p>d.c. supply =</p> </td> <td style="vertical-align: top;"> <table border="1"> <thead> <tr> <th colspan="5">Power switched in W for 5 million operating cycles</th> </tr> <tr> <th>Voltage</th> <th>V</th> <th>24</th> <th>48</th> <th>120</th> </tr> </thead> <tbody> <tr> <td>mm</td> <td>W</td> <td>3</td> <td>2</td> <td>1</td> </tr> </tbody> </table> </td> <td style="vertical-align: top;"> <table border="1"> <thead> <tr> <th colspan="5">Power switched in W for 5 million operating cycles</th> </tr> <tr> <th>Voltage</th> <th>V</th> <th>24</th> <th>48</th> <th>120</th> </tr> </thead> <tbody> <tr> <td>mm</td> <td>W</td> <td>4</td> <td>3</td> <td>3</td> </tr> </tbody> </table> </td> </tr> </table>	<p>a.c. supply ~ 50/60 Hz mm inductive circuit</p>	<p>XCMD snap action (N/C + N/O, N/C + N/C, N/C + N/C + N/O, N/C + N/C + N/O + N/O contacts)</p>	<p>XCMD slow break (N/C + N/O, N/C + N/C + N/O contacts)</p>	<p>d.c. supply =</p>	<table border="1"> <thead> <tr> <th colspan="5">Power switched in W for 5 million operating cycles</th> </tr> <tr> <th>Voltage</th> <th>V</th> <th>24</th> <th>48</th> <th>120</th> </tr> </thead> <tbody> <tr> <td>mm</td> <td>W</td> <td>3</td> <td>2</td> <td>1</td> </tr> </tbody> </table>	Power switched in W for 5 million operating cycles					Voltage	V	24	48	120	mm	W	3	2	1	<table border="1"> <thead> <tr> <th colspan="5">Power switched in W for 5 million operating cycles</th> </tr> <tr> <th>Voltage</th> <th>V</th> <th>24</th> <th>48</th> <th>120</th> </tr> </thead> <tbody> <tr> <td>mm</td> <td>W</td> <td>4</td> <td>3</td> <td>3</td> </tr> </tbody> </table>	Power switched in W for 5 million operating cycles					Voltage	V	24	48	120	mm	W	4	3	3
<p>a.c. supply ~ 50/60 Hz mm inductive circuit</p>	<p>XCMD snap action (N/C + N/O, N/C + N/C, N/C + N/C + N/O, N/C + N/C + N/O + N/O contacts)</p>	<p>XCMD slow break (N/C + N/O, N/C + N/C + N/O contacts)</p>																																				
<p>d.c. supply =</p>	<table border="1"> <thead> <tr> <th colspan="5">Power switched in W for 5 million operating cycles</th> </tr> <tr> <th>Voltage</th> <th>V</th> <th>24</th> <th>48</th> <th>120</th> </tr> </thead> <tbody> <tr> <td>mm</td> <td>W</td> <td>3</td> <td>2</td> <td>1</td> </tr> </tbody> </table>	Power switched in W for 5 million operating cycles					Voltage	V	24	48	120	mm	W	3	2	1	<table border="1"> <thead> <tr> <th colspan="5">Power switched in W for 5 million operating cycles</th> </tr> <tr> <th>Voltage</th> <th>V</th> <th>24</th> <th>48</th> <th>120</th> </tr> </thead> <tbody> <tr> <td>mm</td> <td>W</td> <td>4</td> <td>3</td> <td>3</td> </tr> </tbody> </table>	Power switched in W for 5 million operating cycles					Voltage	V	24	48	120	mm	W	4	3	3						
Power switched in W for 5 million operating cycles																																						
Voltage	V	24	48	120																																		
mm	W	3	2	1																																		
Power switched in W for 5 million operating cycles																																						
Voltage	V	24	48	120																																		
mm	W	4	3	3																																		

Limit Switches

Osiswitch® Miniature, Metal

Universal, XCMD, Pre-Cabled

Type of head Plunger (mounting by the body) Plunger (mounting by the head)

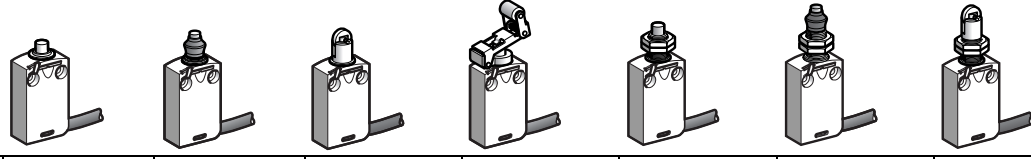

Type of operator	Metal end plunger	Metal end plunger with elastomer boot	Steel roller plunger	Retractable steel roller lever plunger	M12 with metal end plunger	M16 with metal end plunger with elastomer boot	M12 with steel roller plunger
------------------	-------------------	---------------------------------------	----------------------	--	----------------------------	--	-------------------------------

Catalog numbers

2-pole N/C + N/O snap action 	XCMD2110L1 	XCMD2111L1 	XCMD2102L1 	XCMD2124L1 	XCMD21F0L1 	XCMD21G1L1 	XCMD21F2L1
2-pole N/C + N/O break before make, slow break 	XCMD2510L1 	XCMD2511L1 	XCMD2502L1 	XCMD2524L1 	XCMD25F0L1 	XCMD25G1L1 	XCMD25F2L1
2-pole N/C + N/C snap action 	ZCMD29L1 + ZCE10 	ZCMD29L1 + ZCE11 	ZCMD29L1 + ZCE02 	ZCMD29L1 + ZCE24 	ZCMD29L1 + ZCEF0 	ZCMD29L1 + ZCEG1 	ZCMD29L1 + ZCEF2
3-pole N/C + N/C + N/O snap action 	ZCMD39L1 + ZCE10 	ZCMD39L1 + ZCE11 	ZCMD39L1 + ZCE02 	ZCMD39L1 + ZCE24 	ZCMD39L1 + ZCEF0 	ZCMD39L1 + ZCEG1 	ZCMD39L1 + ZCEF2
3-pole N/C + N/C + N/O break before make, slow break 	ZCMD37L1 + ZCE10 	ZCMD37L1 + ZCE11 	ZCMD37L1 + ZCE02 	ZCMD37L1 + ZCE24 	ZCMD37L1 + ZCEF0 	ZCMD37L1 + ZCEG1 	ZCMD37L1 + ZCEF2
Weight, kg (lb)	0.180 (0.397)	0.180 (0.397)	0.185 (0.408)	0.200 (0.441)	0.195 (0.430)	0.220 (0.485)	0.205 (0.452)
4-pole N/C + N/C + N/O + N/O snap action 	ZCMD41L1 + ZCE10 	ZCMD41L1 + ZCE11 	ZCMD41L1 + ZCE02 	ZCMD41L1 + ZCE24 	ZCMD41L1 + ZCEF0 	ZCMD41L1 + ZCEG1 	ZCMD41L1 + ZCEF2
Weight, kg (lb)	0.160 (0.353)	0.160 (0.353)	0.165 (0.364)	0.180 (0.397)	0.175 (0.386)	0.200 (0.441)	0.185 (0.408)

Contact operation
(A) = cam displacement
⊙ N/C contact with positive opening operation, when properly mounted and using a conforming operator
(P) = positive opening point

Characteristics

Switch actuation	On end	By 30° cam	On end	By 30° cam
Type of actuation				
Maximum actuation speed	0.5 m/s (1.64 ft/s)		0.1 m/s (0.33 ft/s)	
Minimum force or torque	For tripping	8.5 N (1.91 lb)	7 N (1.57 lb)	2.5 N (0.56 lb)
	For positive opening	42.5 N (9.55 lb)	35 N (7.87 lb)	12.5 N (2.81 lb)







Cabling
 PvR cable, 1 m (3.3 ft) long: 5 x 0.75 mm² for 2-pole contact versions; 7 x 0.5 mm² for 3-pole contact versions; 9 x 0.34 mm² for 4-pole contact versions. For other cable lengths, see page 44.

NOTE: For more information, consult pages 40–42.

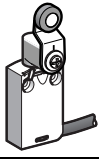
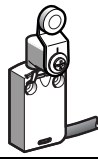
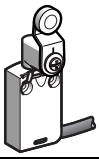
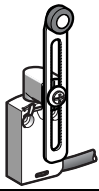
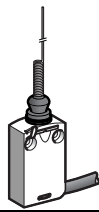
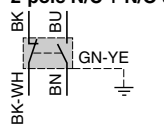
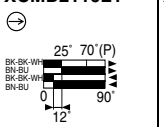
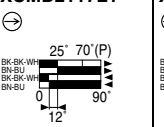
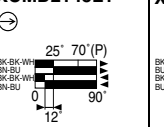
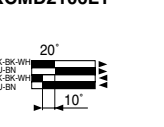
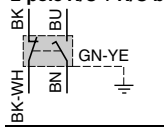
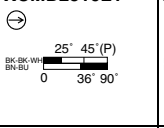
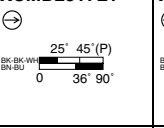
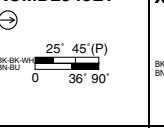
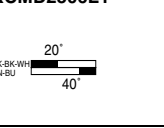
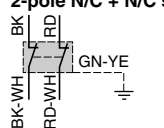
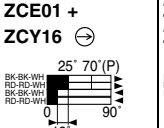
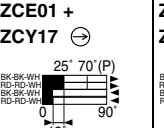
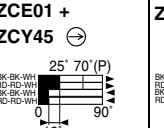
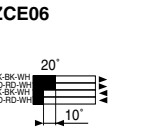
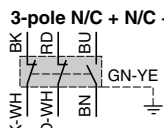
Limit Switches

Osiswitch® Miniature, Metal

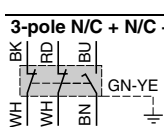
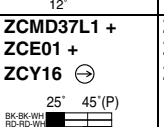
Universal, XCMD, Pre-Cabled

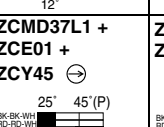
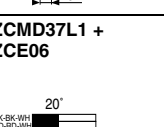
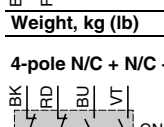
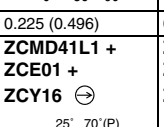
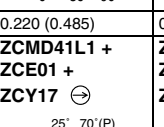
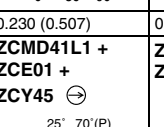
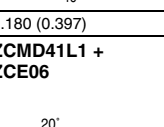
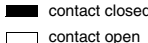
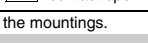
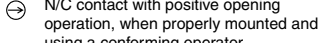
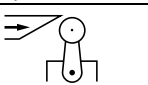
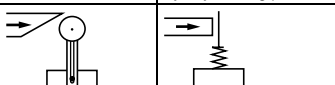
Type of head	Rotary (mounting by the body)			Multi-directional	
					
Type of operator	Thermoplastic roller lever	Steel roller lever	Roller lever with ball bearing mounted roller	Variable length thermoplastic roller lever	Cat's whisker (1)
Catalog numbers					
2-pole N/C + N/O snap action	 XCMD2115L1	 XCMD2116L1	 XCMD2117L1	 XCMD2145L1	 XCMD2106L1
2-pole N/C + N/O break before make, slow break	 XCMD2515L1	 XCMD2516L1	 XCMD2517L1	 XCMD2545L1	 XCMD2506L1
2-pole N/C + N/C snap action	 ZCMD29L1 + ZCE01 + ZCY15	 ZCMD29L1 + ZCE01 + ZCY16	 ZCMD29L1 + ZCE01 + ZCY17	 ZCMD29L1 + ZCE01 + ZCY45	 ZCMD29L1 + ZCE06
3-pole N/C + N/C + N/O snap action	 ZCMD39L1 + ZCE01 + ZCY15	 ZCMD39L1 + ZCE01 + ZCY16	 ZCMD39L1 + ZCE01 + ZCY17	 ZCMD39L1 + ZCE01 + ZCY45	 ZCMD39L1 + ZCE06
3-pole N/C + N/C + N/O break before make, slow break	 ZCMD37L1 + ZCE01 + ZCY15	 ZCMD37L1 + ZCE01 + ZCY16	 ZCMD37L1 + ZCE01 + ZCY17	 ZCMD37L1 + ZCE01 + ZCY45	 ZCMD37L1 + ZCE06
Weight, kg (lb)	0.220 (0.485)	0.225 (0.496)	0.220 (0.485)	0.230 (0.507)	0.180 (0.397)
4-pole N/C + N/C + N/O + N/O snap action	 ZCMD41L1 + ZCE01 + ZCY15	 ZCMD41L1 + ZCE01 + ZCY16	 ZCMD41L1 + ZCE01 + ZCY17	 ZCMD41L1 + ZCE01 + ZCY45	 ZCMD41L1 + ZCE06
Weight, kg (lb)	0.200 (0.441)	0.205 (0.452)	0.200 (0.441)	0.210 (0.463)	0.160 (0.353)
Contact operation	 contact closed  contact open	(A) = cam displacement (P) = positive opening point		 N/C contact with positive opening operation, when properly mounted and using a conforming operator	
1. Value taken with actuation by moving part at 100 mm (3.94 in.) from the mountings.					
Characteristics					
Switch actuation	By 30° cam			By any moving part	
Type of actuation					
Maximum actuation speed	1.5 m/s (4.92 ft/s)			1 m/s (3.28 ft/s)	
Minimum force or torque	For tripping: 0.1 N*m (0.89 lb-in) For positive opening: 0.5 N*m (4.43 lb-in)			—	
Cabling	PvR cable, 1 m (3.3 ft) long: 5 x 0.75 mm ² for 2-pole contact versions; 7 x 0.5 mm ² for 3-pole contact versions, 9 x 0.34 mm ² for 4-pole contact versions. For other cable lengths, see page 44.				

NOTE: For more information, consult pages 40–42.

Limit Switches

Osiswitch® Miniature, Metal

Universal, XCMD, Pre-Cabled—Dimensions

XCMD2•10L1

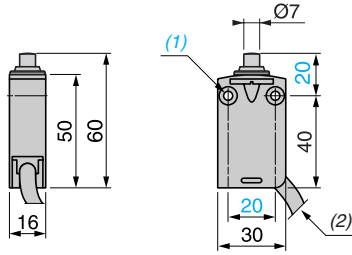

XCMD2•11L1

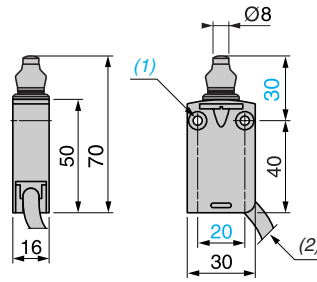

XCMD2•02L1

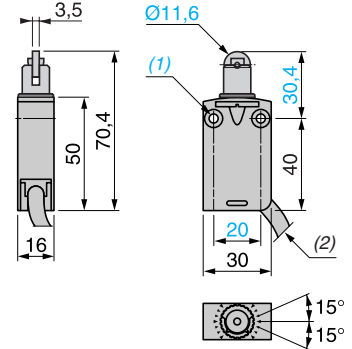

XCMD2•24L1

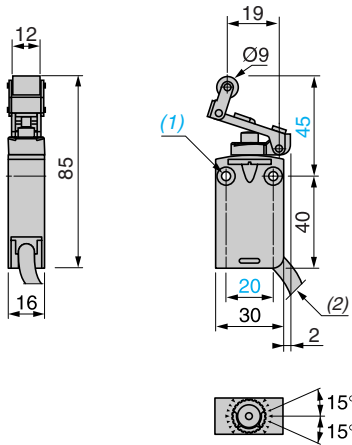

XCMD2•F0L1

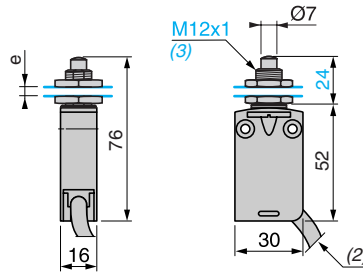

XCMD2•G1L1

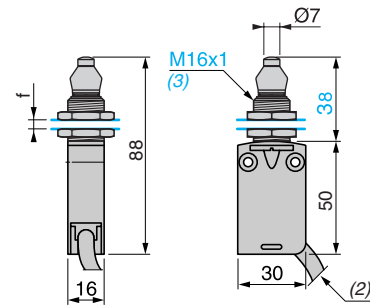

XCMD2•F2L1

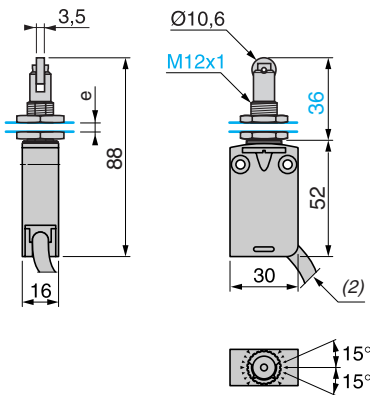

1. 2 mounting holes $\text{Ø} 4.2 \text{ mm}$ (0.17 in.), counterbored $\text{Ø} 8 \text{ mm}$ (0.31 in.) by 4 mm (0.16 in.) deep.
2. Overall diameter of cable 7.5 mm (0.30 in.).
3. Mounting nut thickness 3.5 mm (0.14 in.).
- e: 8 mm (0.31 in.) max, panel cut-out $\text{Ø} 12.5 \text{ mm}$ (0.49 in.).
- f: 8 mm (0.31 in.) max, panel cut-out $\text{Ø} 16.5 \text{ mm}$ (0.65 in.).

Limit Switches

Osiswitch® Miniature, Metal

Universal, XCMD, Pre-Cabled—Dimensions

XCMD2•15L1

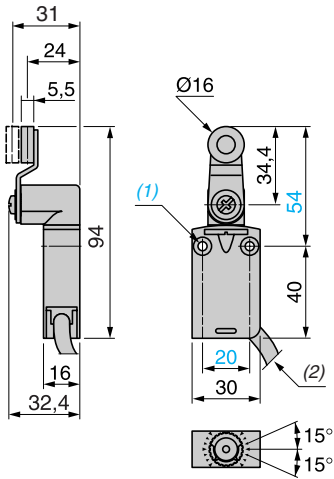

XCMD2•16L1

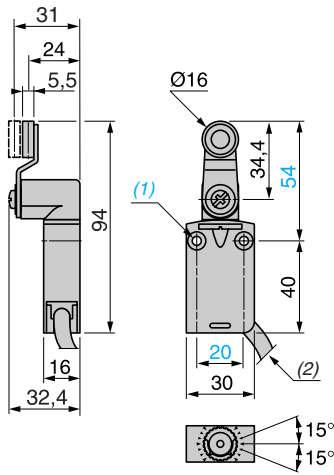

XCMD2•17L1

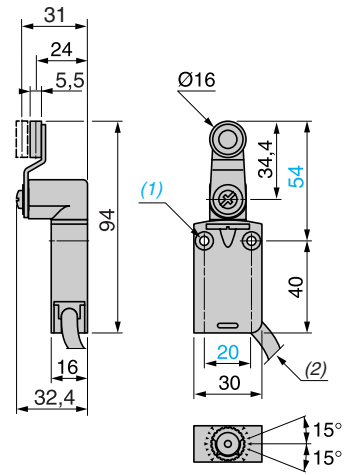

XCMD2•45L1

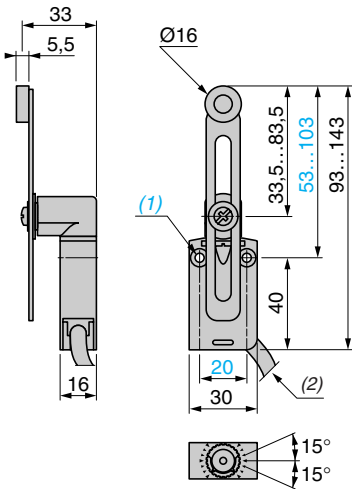

XCMD2•06L1

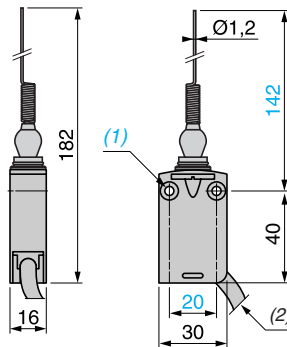

- 1. 2 mounting holes \varnothing 4.2 mm (0.17 in.), counterbored \varnothing 8 mm (0.31 in.) by 4 mm (0.16 in.) deep.
- 2. Overall diameter of cable 7.5 mm (0.30 in.).
- e: 8 mm (0.31 in.) max, panel cut-out \varnothing 12.5 mm (0.49 in.).
- f: 8 mm (0.31 in.) max, panel cut-out \varnothing 16.5 mm (0.65 in.).

Limit Switches

Osiswitch® Miniature, Metal

Universal, XCMD, Integral or Remote Connector

Type of head Plunger (mounting by the body) Plunger (mounting by the head)

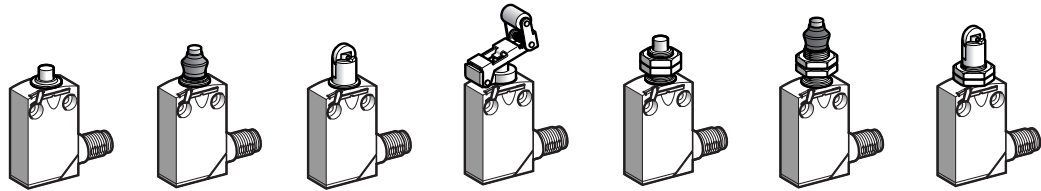

Type of operator Metal end plunger Metal end plunger with elastomer boot Steel roller plunger Retractable steel roller lever plunger M12 with metal end plunger M16 with metal end plunger with elastomer boot M12 with steel roller plunger

Catalog numbers

<p>Single-pole C/O snap action + integral M12 4-pin connector</p>	<p>XCMD2110M12 1,8 4,2(P) 0,8 5mm</p>	<p>XCMD2111M12 1,8 4,2(P) 0,8 5mm</p>	<p>XCMD2102M12 3,1(A) 7(P) 1,4 mm</p>	<p>XCMD2124M12 11,2(A) 25(P) 0 4,9 mm</p>	<p>XCMD21F0M12 1,8 4,2(P) 0,8 5mm</p>	<p>XCMD21G1M12 1,8 4,2(P) 0,8 5mm</p>	<p>XCMD21F2M12 3,1(A) 7(P) 1,4 mm</p>
<p>2-pole N/C + N/O snap action + integral M12 5-pin connector</p>	<p>XCMD2110C12 1,8 4,2(P) 0,8 5mm</p>	<p>XCMD2111C12 1,8 4,2(P) 0,8 5mm</p>	<p>XCMD2102C12 3,1(A) 7(P) 1,4 mm</p>	<p>XCMD2124C12 11,2(A) 25(P) 0 4,9 mm</p>	<p>XCMD21F0C12 1,8 4,2(P) 0,8 5mm</p>	<p>XCMD21G1C12 1,8 4,2(P) 0,8 5mm</p>	<p>XCMD21F2C12 3,1(A) 7(P) 1,4 mm</p>
<p>2-pole N/C + N/C snap action + integral M12 5-pin connector</p>	<p>ZCMD29C12 + ZCE10 1,8 4,2(P) 0,8 5mm</p>	<p>ZCMD29C12 + ZCE11 1,8 4,2(P) 0,8 5mm</p>	<p>ZCMD29C12 + ZCE02 3,1(A) 7(P) 1,4 mm</p>	<p>ZCMD29C12 + ZCE24 11,2(A) 25(P) 0 4,9 mm</p>	<p>ZCMD29C12 + ZCEF0 1,8 4,2(P) 0,8 5mm</p>	<p>ZCMD29C12 + ZCEG1 1,8 4,2(P) 0,8 5mm</p>	<p>ZCMD29C12 + ZCEF2 3,1(A) 7(P) 1,4 mm</p>
<p>Weight, kg (lb)</p>	0.085 (0.187)	0.085 (0.187)	0.090 (0.198)	0.105 (0.231)	0.100 (0.220)	0.125 (0.276)	0.110 (0.243)
<p>2-pole N/C + N/O snap action + M12 5-pin connector on 0.8 m (2.6 ft) flying lead</p>	<p>ZCMD21L08R12 + ZCE10 1,8 4,2(P) 0,8 5mm</p>	<p>ZCMD21L08R12 + ZCE11 1,8 4,2(P) 0,8 5mm</p>	<p>ZCMD21L08R12 + ZCE02 3,1(A) 7(P) 1,4 mm</p>	<p>ZCMD21L08R12 + ZCE24 11,2(A) 25(P) 0 4,9 mm</p>	<p>ZCMD21L08R12 + ZCEF0 1,8 4,2(P) 0,8 5mm</p>	<p>ZCMD21L08R12 + ZCEG1 1,8 4,2(P) 0,8 5mm</p>	<p>ZCMD21L08R12 + ZCEF2 3,1(A) 7(P) 1,4 mm</p>
<p>2-pole N/C + N/O snap action + 7/8" 16UN 5-pin connector on 0.8 m (2.6 ft) flying lead</p>	<p>ZCMD21L08U78 + ZCE10 1,8 4,2(P) 0,8 5mm</p>	<p>ZCMD21L08U78 + ZCE11 1,8 4,2(P) 0,8 5mm</p>	<p>ZCMD21L08U78 + ZCE02 3,1(A) 7(P) 1,4 mm</p>	<p>ZCMD21L08U78 + ZCE24 11,2(A) 25(P) 0 4,9 mm</p>	<p>ZCMD21L08U78 + ZCEF0 1,8 4,2(P) 0,8 5mm</p>	<p>ZCMD21L08U78 + ZCEG1 1,8 4,2(P) 0,8 5mm</p>	<p>ZCMD21L08U78 + ZCEF2 3,1(A) 7(P) 1,4 mm</p>
<p>Weight, kg (lb)</p>	0.150 (0.331)	0.150 (0.331)	0.155 (0.342)	0.170 (0.375)	0.165 (0.364)	0.190 (0.419)	0.175 (0.386)
<p>Contact operation</p>	contact closed contact open		(A) = cam displacement (P) = positive opening point		N/C contact with positive opening operation, when properly mounted and using a conforming operator		

Characteristics

Switch actuation	On end	By 30° cam		On end	By 30° cam
Type of actuation					
Maximum actuation speed	0.5 m/s (1.64 ft/s)				0.1 m/s (0.33 ft/s)
Minimum force or torque	For tripping	8.5 N (1.91 lb)	7 N (1.57 lb)	2.5 N (0.56 lb)	8.5 N (1.91 lb)
	For positive opening	42.5 N (9.55 lb)	35 N (7.87 lb)	12.5 N (2.81 lb)	42.5 N (9.55 lb)
Positive operation	Although their design is identical to the pre-cabled switches, the switches incorporating an M12 4-pin connector cannot be marked with the symbol because they are single-pole C/O.				

NOTE: For more information, consult pages 40–42.

Limit Switches

Osiswitch® Miniature, Metal

Universal, XCMD, Integral or Remote Connector

Type of head	Rotary (mounting by the body)				Multi-directional	
Type of operator	Thermoplastic roller lever	Steel roller lever	Roller lever with ball bearing mounted roller	Variable length thermoplastic roller lever	Cat's whisker (1)	
Catalog numbers						
 Single-pole C/O snap action With integral M12 4-pin connector	XCMD2115M12 	XCMD2116M12 	XCMD2117M12 	XCMD2145M12 	XCMD2106M12 	
 2-pole N/C + N/O snap action With integral M12 5-pin connector	XCMD2115C12 	XCMD2116C12 	XCM D2117C12 	XCMD2145C12 	XCMD2106C12 	
 2-pole N/C + N/C snap action With integral M12 5-pin connector	ZCMD29C12 + ZCE01 + ZCY15 	ZCMD29C12 + ZCE01 + ZCY16 	ZCMD29C12 + ZCE01 + ZCY17 	ZCMD29C12 + ZCE01 + ZCY45 	ZCMD29C12 + ZCE06 	
Weight, kg (lb)	0.125 (0.276)	0.130 (0.287)	0.125 (0.276)	0.135 (0.298)	0.085 (0.187)	
 2-pole N/C + N/O snap action With M12 5-pin connector on 0.8 m (2.6 ft) flying lead	ZCMD21L08R12 + ZCE01 + ZCY15 	ZCMD21L08R12 + ZCE01 + ZCY16 	ZCMD21L08R12 + ZCE01 + ZCY17 	ZCMD21L08R12 + ZCE01 + ZCY45 	ZCMD21L08R12 + ZCE06 	
 2-pole N/C + N/O snap action With 7/8" 16UN 5-pin connector on 0.8 m (2.6 ft) flying lead	ZCMD21L08U78 + ZCE01 + ZCY15 	ZCMD21L08U78 + ZCE01 + ZCY16 	ZCMD21L08U78 + ZCE01 + ZCY17 	ZCMD21L08U78 + ZCE01 + ZCY45 	ZCMD21L08U78 + ZCE06 	
Weight, kg (lb)	0.200 (0.441)	0.205 (0.452)	0.200 (0.441)	0.210 (0.463)	0.160 (0.353)	
Contact operation	contact closed contact open	(A) = cam displacement (P) = positive opening point		N/C contact with positive opening operation, when properly mounted and using a conforming operator		
1. Value taken with actuation by moving part at 100 mm (3.94 in.) from the mounting.						
Characteristics						
Switch actuation	By 30° cam			By any moving part		
Type of actuation						
Maximum actuation speed	1.5 m/s (4.92 ft/s)			1 m/s (3.28 ft/s)		
Minimum force or torque	For tripping	0.1 N•m (0.89 lb-in)				
	For positive opening	0.5 N•m (4.43 lb-in)				
Positive operation	Although their design is identical to the pre-cabled switches, the switches incorporating an M12 4-pin connector cannot be marked with the symbol because they are single-pole C/O.					

Limit Switches

Osiswitch® Miniature, Metal

Universal, XCMD—Modular

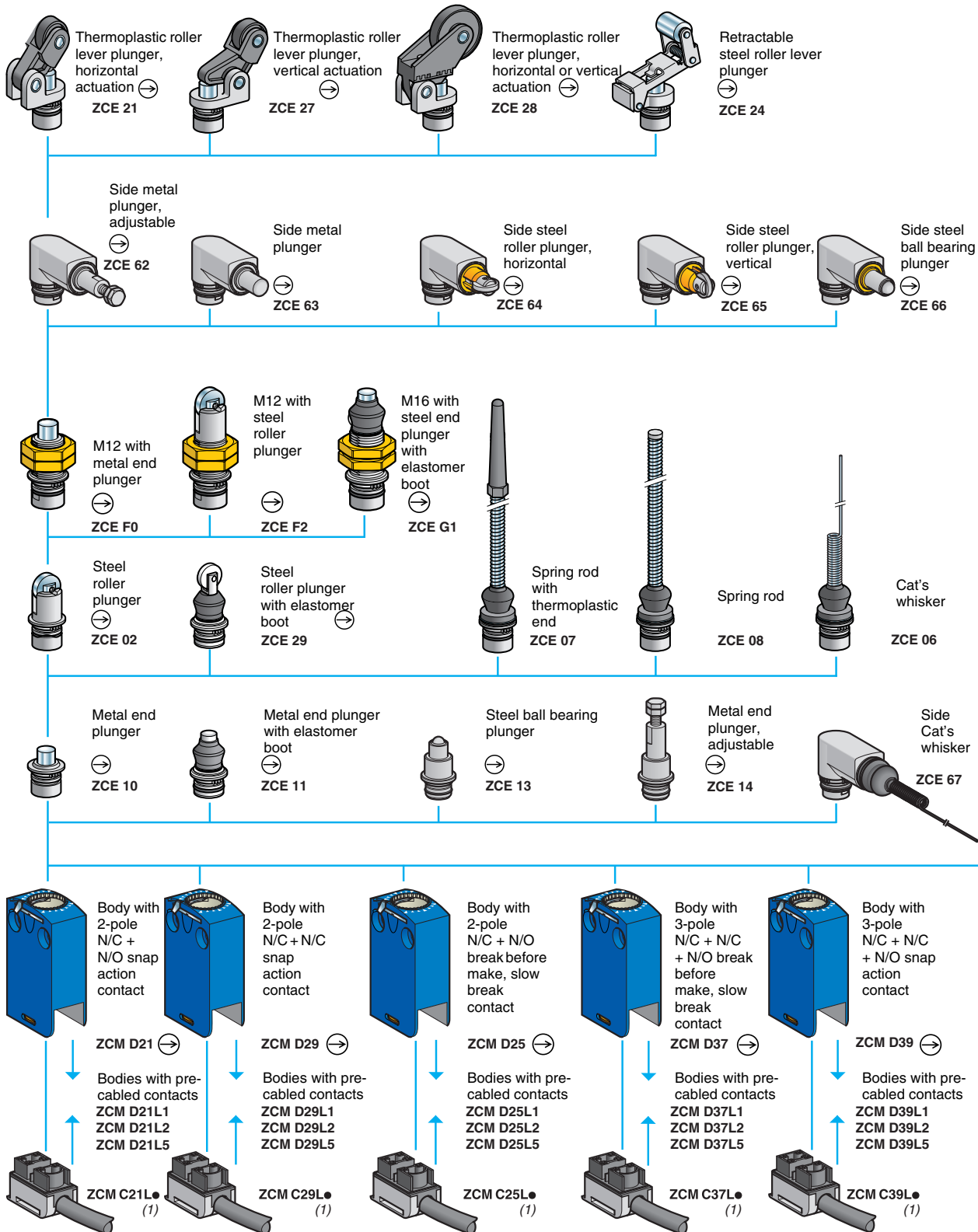

1. Pre-cabled connection components: replace the "*" in the catalog number with the required cable length in meters, either: 1, 2, 3, 5, 7 or 10.
 Example: ZCM C21L* becomes ZCM C21L7 for a 7 m (23.0 ft) cable.
 Note: only cable lengths of 1, 2 and 5 m (3.3, 6.6, and 16.4 ft) are available for pre-cabled connection components ZCM C37L* and ZCM C39L*.

Limit Switches

Osiswitch® Miniature, Metal

Universal, XCMD—Modular

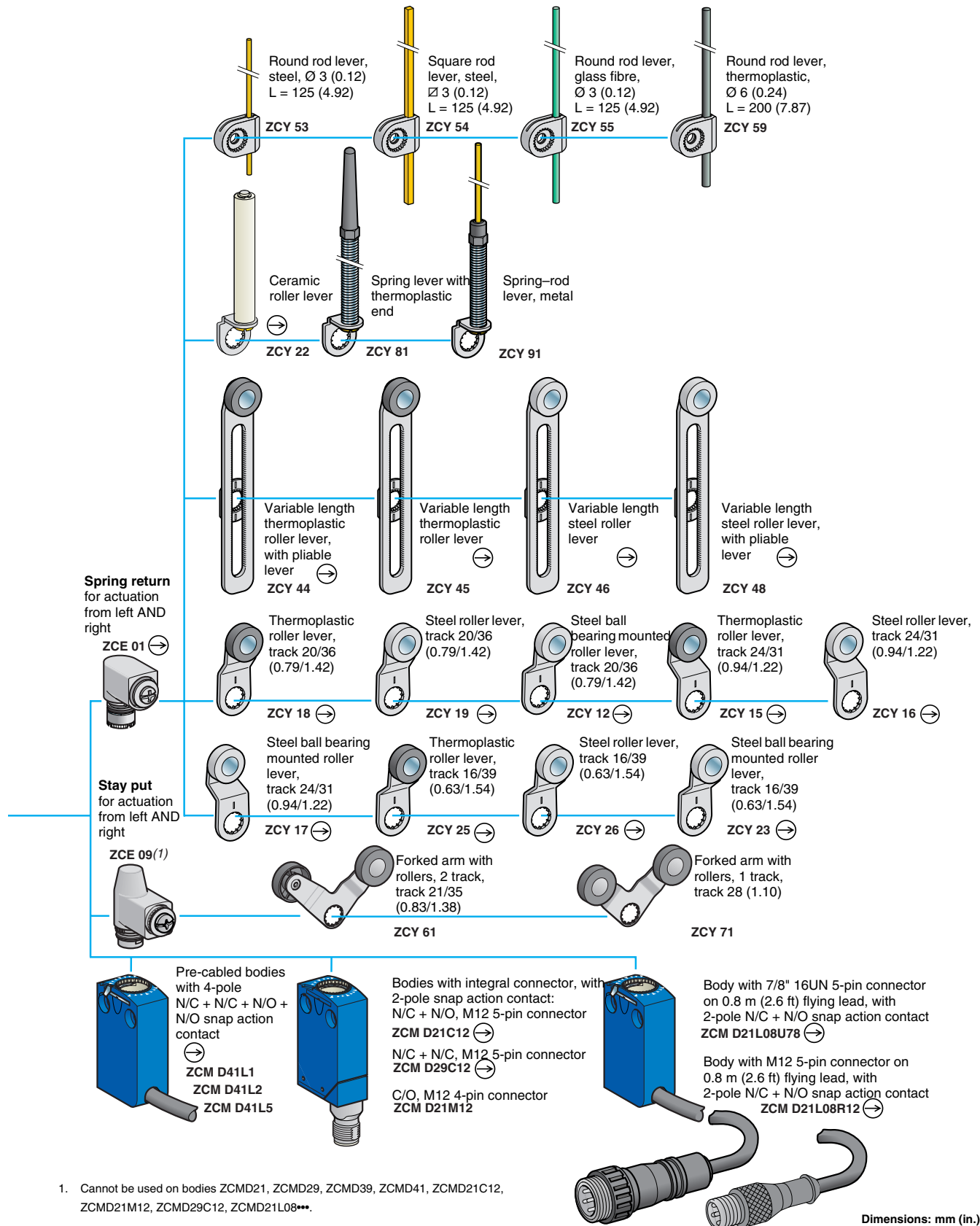

1. Cannot be used on bodies ZCMD21, ZCMD29, ZCMD39, ZCMD41, ZCMD21C12, ZCMD21M12, ZCMD29C12, ZCMD21L08***.

Limit Switches

Osiswitch® Miniature, Metal

Universal, XCMD—Modular

Special Features and Catalog Number Explanation

Interpretation of the Catalog Number

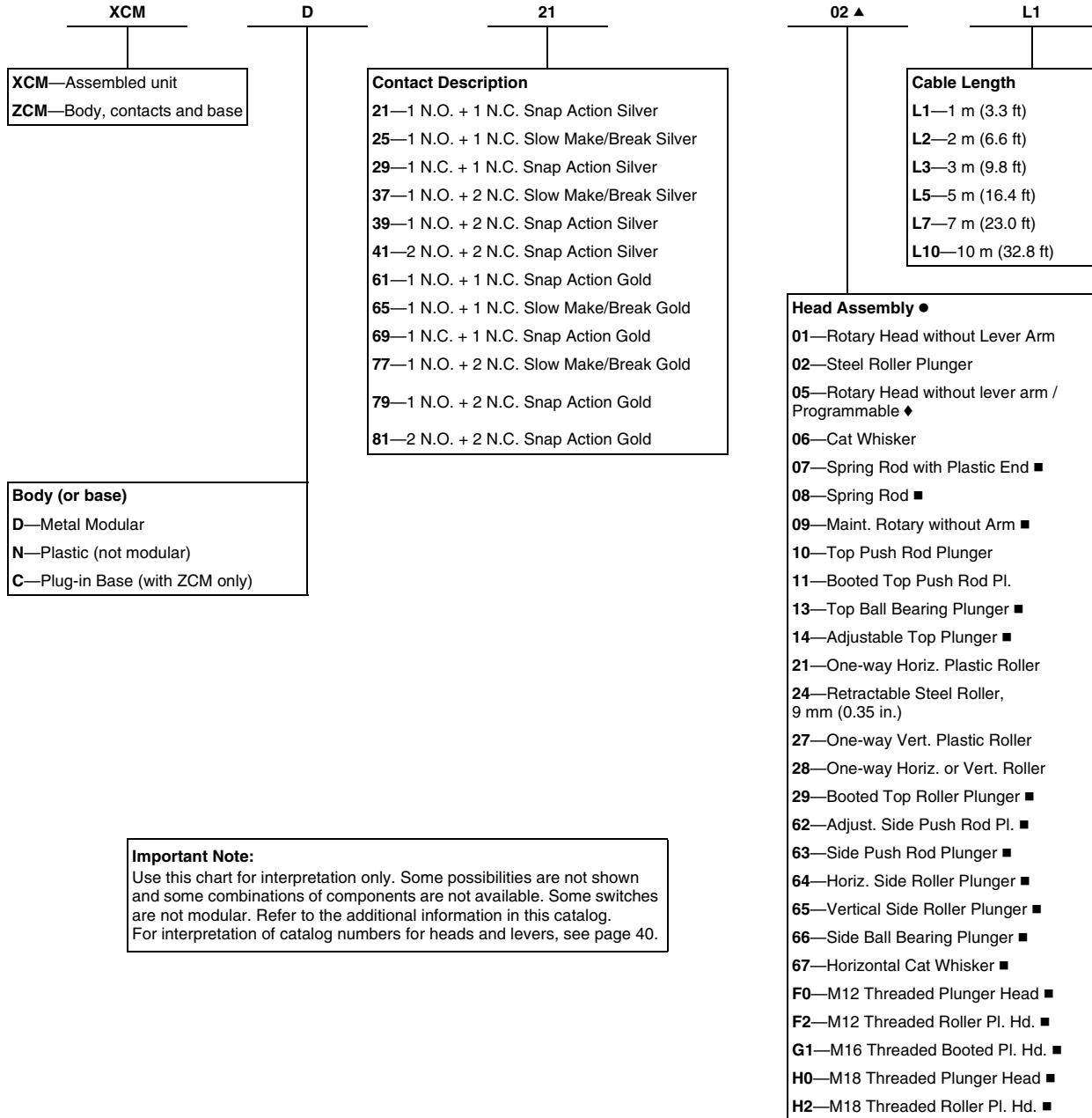

Important Note:
 Use this chart for interpretation only. Some possibilities are not shown and some combinations of components are not available. Some switches are not modular. Refer to the additional information in this catalog. For interpretation of catalog numbers for heads and levers, see page 40.

- Consult your local field sales office for availability.
- ▲ Last two digits of lever catalog number occupy this position when rotary heads with levers are required.
- See page 40 for levers.
- ◆ See page 45 for available levers, specifically allowed for the ZCE05 programmable head.

Limit Switches

Osiswitch® Miniature, Metal

Universal, XCMD—Modular

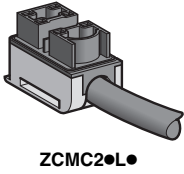

Components

Plug-in base with PVR cable ♦				
Contact type	Diagram	Length of PVR cable m (ft)	Catalog number ■	Weight lb (kg)
2-pole				
2-pole N.C. + N.O. snap action		1 (3.3)	ZCMC21L1	0.22 (0.100)
2-pole N.C. + N.O. snap action		2 (6.6)	ZCMC21L2	0.42 (0.190)
2-pole N.C. + N.O. snap action		3 (9.8)	ZCMC21L3	0.62 (0.280)
2-pole N.C. + N.O. snap action		5 (16.4)	ZCMC21L5	1.00 (0.440)
2-pole N.C. + N.O. snap action		7 (23.0)	ZCMC21L7	1.50 (0.700)
2-pole N.C. + N.O. snap action		10 (32.8)	ZCMC21L10	2.10 (0.970)
2-pole N.C. + N.O. slow break-before-make		1 (3.3)	ZCMC25L1	0.22 (0.100)
2-pole N.C. + N.O. slow break-before-make		2 (6.6)	ZCMC25L2	0.42 (0.190)
2-pole N.C. + N.O. slow break-before-make		3 (9.8)	ZCMC25L3	0.62 (0.280)
2-pole N.C. + N.O. slow break-before-make		5 (16.4)	ZCMC25L5	1.00 (0.440)
2-pole N.C. + N.O. slow break-before-make		7 (23.0)	ZCMC25L7	1.50 (0.700)
2-pole N.C. + N.O. slow break-before-make		10 (32.8)	ZCMC25L10	2.10 (0.970)

♦ The plug-in base receptacle must match the contact pin outs in the body. Only the length of cord is variable. See page 40 for 3-pole plug-in bases with cord. The 4-pole units and connector versions do not have component modular bases. See pages 34 and 35 for 4 contact bodies, and pages 38 and 39 for M12 connector bodies.

- Available cable lengths:
 ZCMC29L•: 1, 2, 3, 5, 7, and 10 m (3.3, 6.6, 9.8, 16.4, 23.0, and 32.8 ft)
 ZCMC37L•: 1, 2, and 5 m (3.3, 6.6, and 16.4 ft)
 ZCMC39L•: 1, 2, and 5 m (3.3, 6.6, and 16.4 ft)

Limit Switches

Osiswitch® Miniature, Metal

Universal, XCMD—Modular

Components

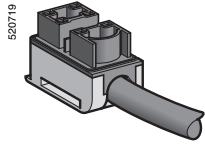

ZCMC21E•

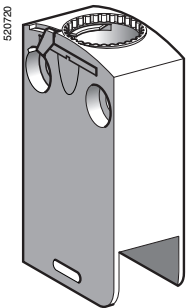

ZCMD6•
ZCMD7•

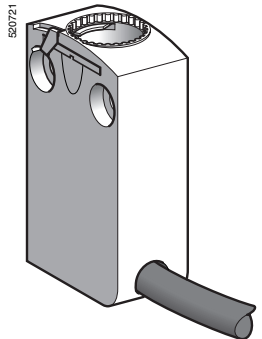

ZCMD81L•

Pre-cabled connection components (CEI cable) (1)

Type of contact	Wiring diagram	Length of CEI cable, m (ft)	Catalog Number	Weight kg (lb)
2-pole				
N/C + N/O snap action		1 (3.28)	ZCMC21E1	0.100 (0.220)
		2 (6.56)	ZCMC21E2	0.190 (0.419)
		3 (9.84)	ZCMC21E3	0.280 (0.617)
		5 (16.40)	ZCMC21E5	0.440 (0.970)
		7 (22.97)	ZCMC21E7	0.700 (1.543)
		10 (32.81)	ZCMC21E10	0.970 (2.138)

Bodies with gold contacts

Type of contact	Positive operation (2)	Wiring diagram	Length of cable, m (ft)	Catalog Number	Weight kg (lb)
2-pole					
N/C + N/O snap action	⊕		—	ZCMD61	0.055 (0.121)
N/C + N/C snap action	⊕		—	ZCMD69	0.055 (0.121)
N/C + N/O break before make, slow break	⊕		—	ZCMD65	0.055 (0.121)
3-pole					
N/C + N/C + N/O snap action	⊕		—	ZCMD79	0.055 (0.121)
N/C + N/C + N/O break before make, slow break	⊕		—	ZCMD77	0.055 (0.121)
4-pole					
N/C + N/C + N/O + N/O snap action	⊕		1 (3.28)	ZCMD81L1	0.160 (0.353)
			2 (6.56)	ZCMD81L2	0.255 (0.562)
			5 (16.40)	ZCMD81L5	0.525 (1.157)

1. Cable not UL, CSA certified.
2. ⊕ bodies with contacts assuring positive opening operation, when properly mounted and using a conforming operator.

Limit Switches

Osiswitch® Miniature, Metal

Universal, XCMD

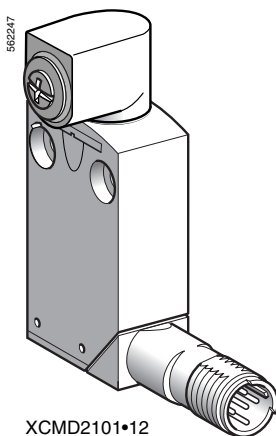
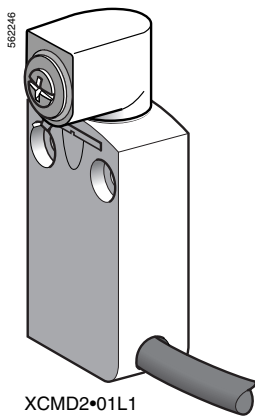
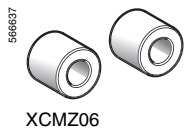
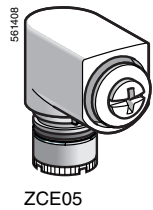
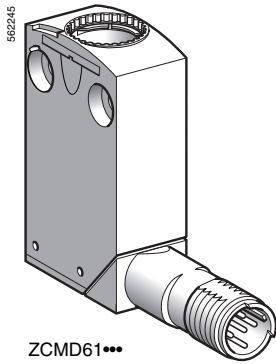

Bodies with gold contacts, integral connector

Type of contact	Positive operation (1)	Wiring diagram	Connector	Catalog Number	Weight kg (lb)
2-pole					
N/C + N/O snap action	—		M12 5-pin	ZCMD61C12	0.065 (0.143)
N/C + N/C snap action	—		M12 5-pin	ZCMD69C12	0.065 (0.143)
Single-pole					
C/O snap action	—		M12 4-pin	ZCMD61M12	0.065 (0.143)

Accessories

Description	Positive operation (1)	Suitable levers for use with head	Catalog Number	Weight kg (lb)
Rotary head, without lever, spring return, for actuation from left AND right or from left OR right (2)		ZCY12, ZCY15, ZCY16, ZCY17, ZCY18, ZCY19, ZCY22, ZCY23, ZCY25, ZCY26, ZCY39, ZCY53, ZCY54, ZCY55, ZCY81	ZCE05	0.045 (0.099)
Spacer for mounting multi-track XCMD	—	—	XCMZ06	0.005 (0.011)
Spacer for angular positioning of heads with adjustable levers, for values other than -90°, 0° and 90°	—	—	XCMZ07	0.005 (0.011)

Bodies with contacts, with rotary head (without operating lever), pre-cabled

Type of contact	Positive operation (1)	Wiring diagram	Length of cable, m (ft)	Catalog Number	Weight kg (lb)
2-pole					
N/C + N/O snap action			1 (3.28)	XCMD2101L1	0.180 (0.397)
N/C + N/O break before make, slow break			1 (3.28)	XCMD2501L1	0.180 (0.397)

Bodies with contacts, with rotary head (without operating lever), integral connector

Type of contact	Positive operation (1)	Wiring diagram	Connector	Catalog Number	Weight kg (lb)
2-pole					
N/C + N/O snap action			M12 5-pin	XCMD2101C12	0.110 (0.243)
Single-pole					
C/O snap action	—		M12 4-pin	XCMD2101M12	0.110 (0.243)

- bodies with contacts or head assuring positive opening operation, when properly mounted and using a conforming operator.
- For programming see page 14.

Limit Switches

Osiswitch® Miniature, Metal

Universal, XCMD—Connector Cabling Accessories

Catalog Numbers of suitable pre-wired female connectors

Type of connector	M12 straight, 4-pin 4 A, 250 V	M12 straight, 5-pin 4 A, 24 V	M12 elbowed, 5-pin 4 A, 24 V	7/8" 16 UN straight, 5-pin, 6 A, 250 V
With cable	L = 2 m (6.56 ft)	XZCP1169L2	XZCP1164L2	XZCP1264L2
	L = 5 m (16.40 ft)	XZCP1169L5	XZCP1164L5	XZCP1264L5
	L = 10 m (32.81 ft)	XZCP1169L10	XZCP1164L10	XZCP1264L10
Weight, kg (lb)	0.105 (0.231)	0.115 (0.254)	0.115 (0.254)	0.190 (0.419)

Connections

XCMD with connector

4-pin, M12

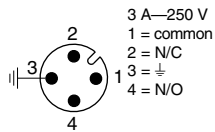

5-pin, M12

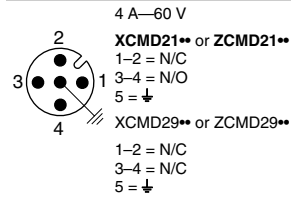

5-pin, 7/8" 16 UN

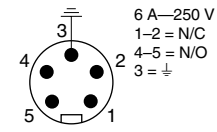

Pre-wired female connectors XZCP

4-pin, M12

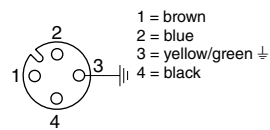

5-pin, M12

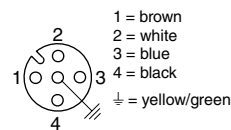

5-pin, 7/8" 16 UN

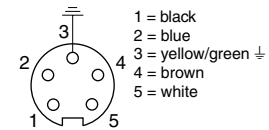

Dimensions

XZCP116•L•

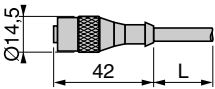

XZCP1264L•

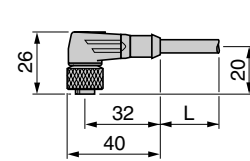

XZCP1771L•

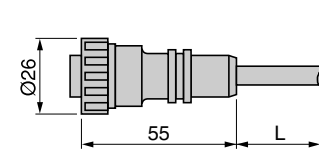

L: cable length 2, 5, or 10 m (6.6, 16.4, or 32.8 ft)

Distances required for plug-in connectors

M12 straight connector

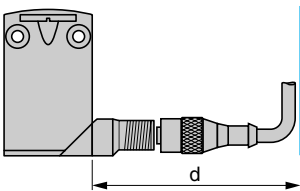

d: min. 65 mm (2.56 in.),
recommended 69 mm (2.72 in.)

M12 elbowed connector

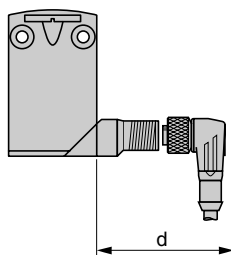

d: min. 42 mm (1.65 in.),
recommended 45 mm (1.77 in.)

Connector on flying lead

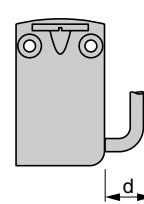

d: min. 20 mm (0.79 in.)

Limit Switches

Osiswitch® Miniature, Metal

Universal, XCMD, Integral or Remote Connector

XCMD2•10M12

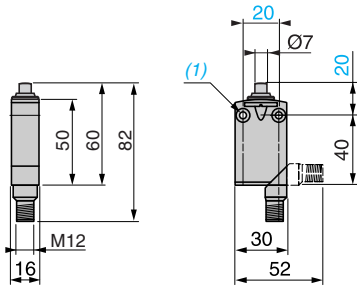

XCMD2•11M12

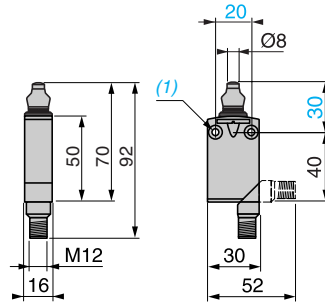

XCMD2•02M12

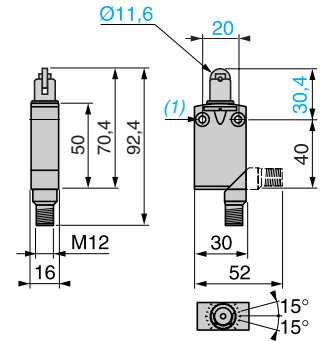

XCMD2•24M12

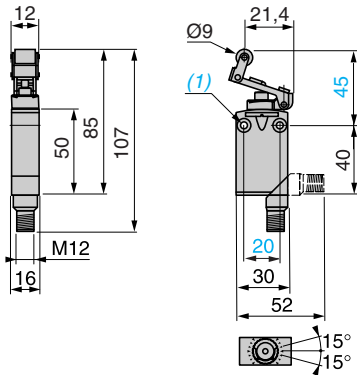

XCMD2•F0M12

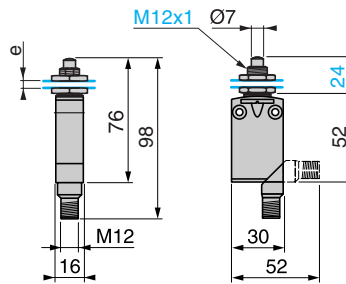

XCMD2•G1M12

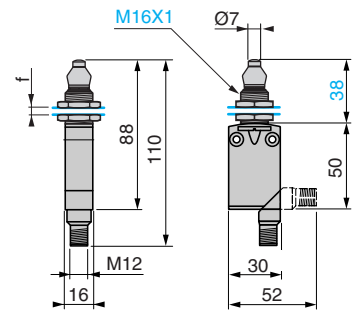

XCMD2•F2M12

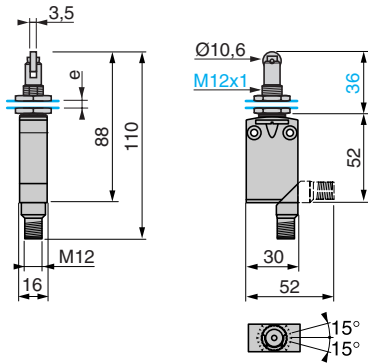

XCMD2•45M12

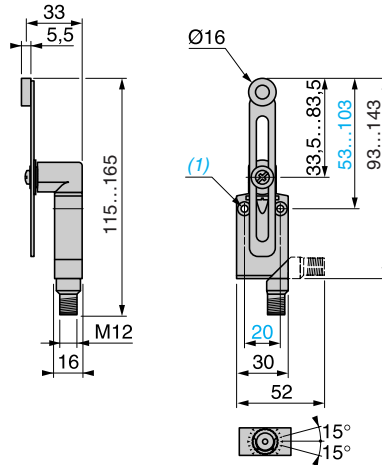

XCMD2•15M12 / 16M12 / 17M12

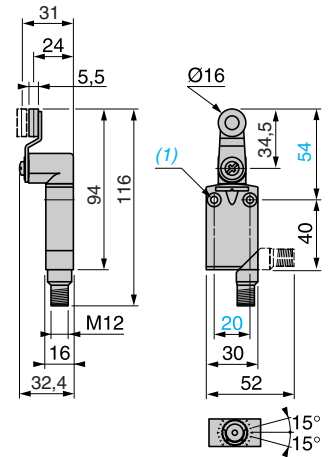

XCMD2•06M12

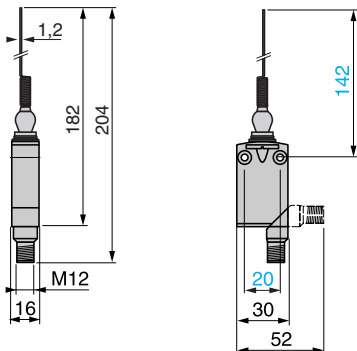

- 1. 2 mounting holes Ø 4.2 mm (0.17 in.), counterbored Ø 8 mm (0.31 in.) by 4 mm (0.16 in.) deep.
- e: 8 mm (0.31 in.) max., panel cut-out Ø 12.5 mm (0.49 in.), mounting nut thickness 3.5 mm (0.14 in.).
- f: 8 mm (0.31 in.) max., panel cut-out Ø 16.5 mm (0.65 in.), mounting nut thickness 3.5 mm (0.14 in.).

Limit Switches

Limit Switches

Osiswitch® Miniature, Metal

Universal, XCMD, Integral or Remote Connector

ZCMD21L08*** + ZCE 10

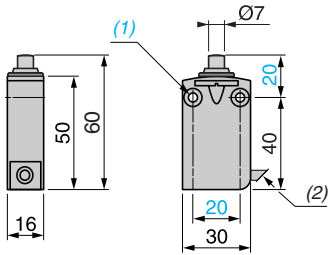

ZCMD21L08*** + ZCE 11

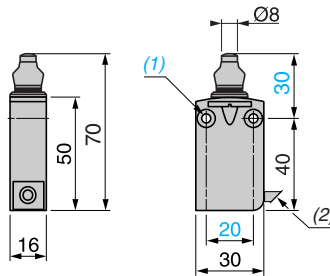

ZCMD21L08*** + ZCE 02

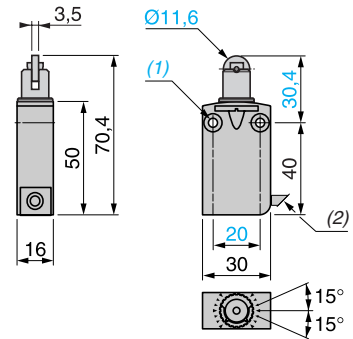

ZCMD21L08*** + ZCE 24

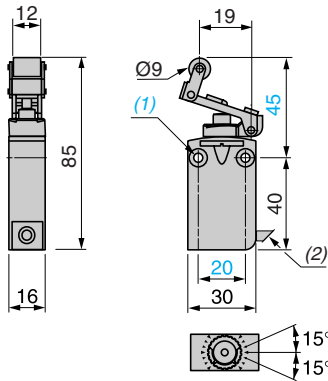

ZCMD21L08*** + ZCE F0

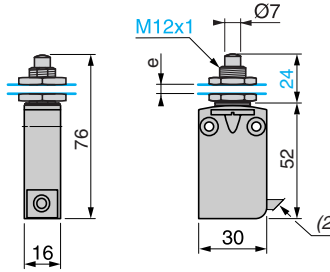

ZCMD21L08*** + ZCE G1

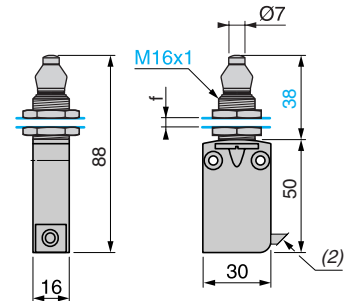

1. 2 mounting holes $\text{Ø} 4.2 \text{ mm}$ (0.17 in.), counterbored $\text{Ø} 8 \text{ mm}$ (0.31 in.) by 4 mm (0.16 in.) deep.
2. Overall diameter 7.5 mm (0.30 in.).
- e: 8 mm (0.31 in.) max., panel cut-out $\text{Ø} 12.5 \text{ mm}$ (0.49 in.), mounting nut thickness 3.5 mm (0.14 in.).
- f: 8 mm (0.31 in.) max., panel cut-out $\text{Ø} 16.5 \text{ mm}$ (0.65 in.), mounting nut thickness 3.5 mm (0.14 in.).

Limit Switches

Osiswitch® Miniature, Metal

Universal, XCMD, Integral or Remote Connector

ZCMD21L08*** + ZCEF2

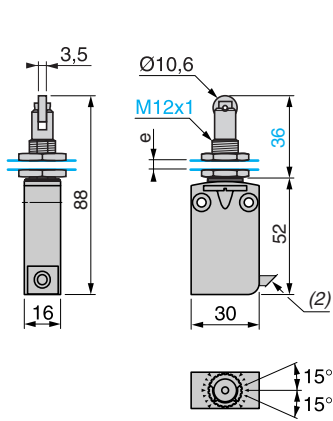

ZCMD21L08*** + ZCE01 + ZCY 15/16/17

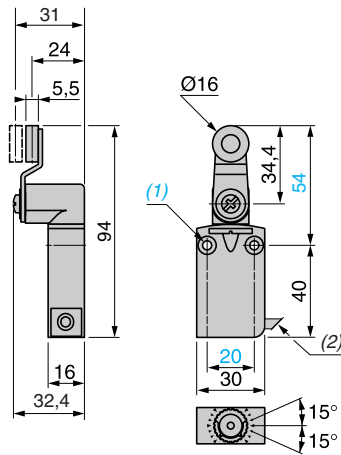

ZCMD21L08*** + ZCE01 + ZCY 45

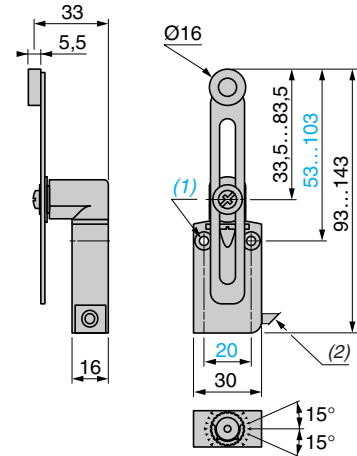

ZCMD21L08*** + ZCE06

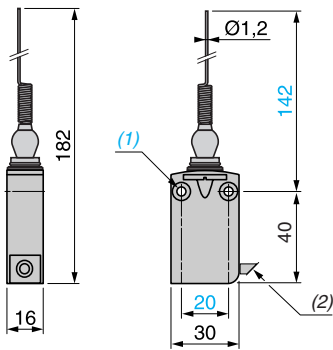

1. 2 mounting holes Ø 4.2 mm (0.17 in.), counterbored Ø 8 mm (0.31 in.) by 4 mm (0.16 in.) deep.
2. Overall diameter 7.5 mm (0.30 in.).
- e: 8 mm (0.31 in.) max., panel cut-out Ø 12.5 mm (0.49 in.), mounting nut thickness 3.5 mm (0.14 in.).
- f: 8 mm (0.31 in.) max., panel cut-out Ø 16.5 mm (0.65 in.), mounting nut thickness 3.5 mm (0.14 in.).

Limit Switches

Osiswitch® Miniature, Plastic

XCMN

■ XCMN
pre-cabled

□ With head for linear movement (plunger). Mounting by the body.

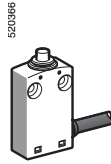

Page 52

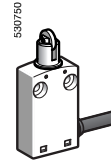

□ With head for linear movement (plunger). Mounting by the head.

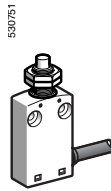

Page 52

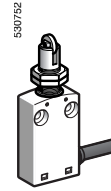

□ With head for rotary movement (lever) or multi-directional.

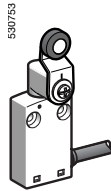

Page 53

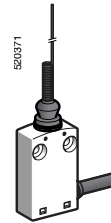

Limit Switches

Osiswitch® Miniature, Plastic

XCMN

Environmental characteristics		
Conforming to standards	Products	IEC 60947-5-1, EN 60947-5-1, UL 508, CSA C22-2 n° 14
	Machine assemblies	IEC 60204-1, EN 60204-1
Product certifications		UL, CSA, CCC
Protective treatment	Standard version	"TC"
Ambient air temperature	Operation	- 25...+70 °C (-13...+158 °F)
	Storage	- 40...+70 °C (-40...+158 °F)
Vibration resistance	Conforming to IEC 60068-2-6	5 gn (10...500 Hz)
Shock resistance	Conforming to IEC 60068-2-27	25 gn (18 ms)
Electric shock protection		Class II conforming to IEC 61140 and NF C 20030
Degree of protection		IP 65 conforming to IEC 60529; IK 04 conforming to EN 50102
Materials	Bodies	Plastic
	Heads	Zamak® zinc alloy
Contact block characteristics		
Rated operational characteristics		~ AC-15; B300 (Ue = 240 V, Ie = 1.5 A); Ithe = 6 A
		== DC-13; R300 (Ue = 250 V, Ie = 0.1 A), conforming to IEC 60947-5-1 Appendix A, EN 60947-5-1
Rated insulation voltage		Ui = 400 V degree of pollution 3 conforming to IEC 60947-1 Ui = 300 V conforming to UL 508, CSA C22-2 n° 14
Rated impulse withstand voltage		U imp = 4 kV conforming to IEC 60947-1, IEC 60664
Short-circuit protection		6 A cartridge fuse type gG (gl)

Limit Switches

Osiswitch® Miniature, Plastic

XCMN, Pre-Cabled

Type of head	Plunger (mounting by the body)				Plunger (mounting by the head)		
Type of operator	Metal end plunger	Steel roller plunger for lateral cam approach	Steel roller plunger for traverse cam approach	Thermoplastic roller lever plunger, 1 direction of actuation	M12 with metal end plunger	M12 with steel roller plunger for lateral cam approach	M12 with steel roller plunger for traverse cam approach

Catalog Numbers		XCMN2110L1	XCMN2102L1	XCMN2103L1	XCMN2121L1	XCMN21F0L1	XCMN21F2L1	XCMN21F3L1
<p>2-pole N/C + N/O snap action</p>								
	Weight, kg (lb)	0.080 (0.176)	0.080 (0.176)	0.080 (0.176)	0.090 (0.198)	0.065 (0.143)	0.095 (0.209)	0.095 (0.209)
Contact operation			(A) = cam displacement (P) = positive opening point					

Characteristics		Plunger (mounting by the body)			Plunger (mounting by the head)	
Switch actuation	On end	By 30° cam		On end	By 30° cam	
Type of actuation						
Maximum actuation speed	0.5 m/s (1.64 ft/s)	0.1 m/s (0.33 ft/s)		0.5 m/s (1.64 ft/s)	0.1 m/s (0.33 ft/s)	
Minimum force or torque	For tripping	8.5 N (1.91 lb)	7 N (1.57 lb)	2.5 N (0.56 lb)	8.5 N (1.91 lb)	7 N (1.57 lb)
	For positive opening	42.5 N (9.55 lb)	35 N (7.87 lb)	12.5 N (2.81 lb)	42.5 N (9.55 lb)	35 N (7.87 lb)
Cabling	PvR cable, 4 x 0.75 mm ² , length 1 m (3.28 ft)					

Dimensions

XCMN2110L1

XCMN2102L1, XCMN2103L1

XCMN21F2L1, XCMN21F3L1

XCMN2121L1

XCMN21F0L1

- 2 mounting holes Ø 4.2 mm (0.17 in.), counterbored Ø 8 mm (0.31 in.) by 4 mm (0.16 in.) deep.
- Overall diameter 7.5 mm (0.30 in.).
- 8 mm (0.31 in.) max. panel cut-out Ø 12.5 mm (0.49 in.), mounting nut thickness 3.5 mm (0.14 in.).

Limit Switches

Osiswitch® Miniature, Plastic

XCMN, Pre-Cabled

Type of head	Rotary (mounting by the body)			Multi-directional	
Type of operator	Thermoplastic roller lever	Variable length thermoplastic roller lever	Round thermoplastic rod lever Ø 6 mm (0.24 in.) (1)	Spring lever with thermoplastic end (1)	Cat's whisker (1)
Catalog Numbers	XCMN2115L1 	XCMN2145L1 	XCMN2159L1 	XCMN2107L1 	XCMN2106L1
Weight, kg (lb)	0.100 (0.220)	0.105 (0.231)	0.080 (0.176)	0.085 (0.187)	0.080 (0.176)
Contact operation			(A) = cam displacement (P) = positive opening point	⊖ N/C contact with positive opening operation, when properly mounted and using a conforming operator	

1. Value taken with actuation by moving part at 100 mm (3.94 in.) from the mountings.

Characteristics

Switch actuation	By 30° cam	By any moving part		
Type of actuation				
Maximum actuation speed	1.5 m/s (4.92 ft/s)	1 m/s (3.28 ft/s)	1 m/s (3.28 ft/s), any direction	
Minimum force or torque	For tripping For positive opening	0.1 N•m (0.89 lb-in) 0.5 N•m (4.43 lb-in)	—	
Cabling	PvR cable, 4 x 0.75 mm ² , length 1 m (3.28 ft)			

Dimensions

XCMN2115L1

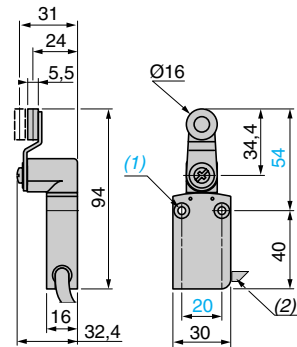

XCMN2159L1

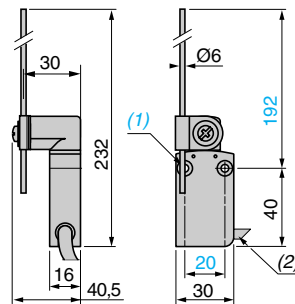

XCMN2107L1

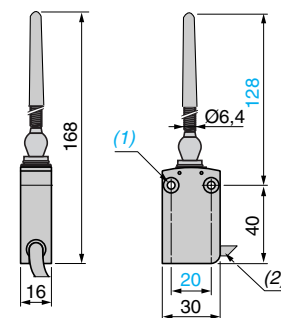

XCMN2145L1

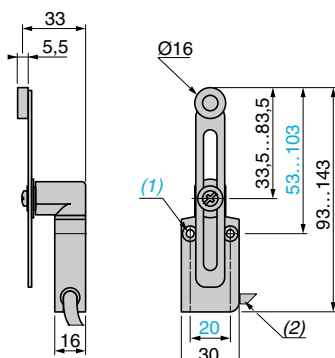

XCMN2106L1

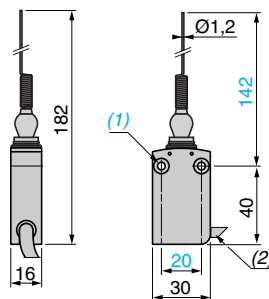

- 2 mounting holes Ø 4.2 mm (0.17 in.), counterbored Ø 8 mm (0.31 in.) by 4 mm (0.16 in.) deep.
- Overall diameter 7.5 mm (0.30 in.).

Limit Switches

Osiswitch® Compact

Universal, XCKP and XCKT Plastic / XCKD Metal

■ **XCKP, XCKD**
with 1 cable entry
Conforming to CENELEC EN 50047

□ With head for linear movement (plunger). Mounting by the head or by the body.
XCKD **XCKP**



Pages 56 and 60

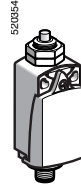

Pages 62 and 66



□ With head for rotary movement (lever) or multi-directional. Mounting by the body.
XCKD **XCKP**

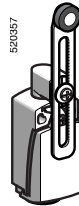

Pages 57 and 61

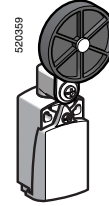

Pages 63 and 67



■ **XCKT**
with 2 cable entries
Tripping/resetting points and mounting centers conform to CENELEC EN 50047

□ With head for linear movement (plunger). Mounting by the head or by the body.
XCKT

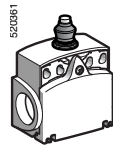

Page 68

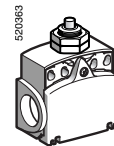
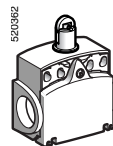

□ With head for rotary movement (lever) or multi-directional. Mounting by the body.
XCKT

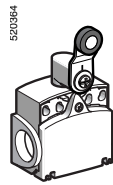

Page 68

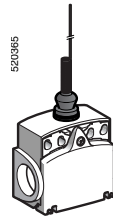

Environmental characteristics

Conforming to standards	Products	IEC 60947-5-1, EN 60947-5-1, UL 508, CSA C22-2 n° 14
	Machine assemblies	IEC 60204-1, EN 60204-1
Product certifications		UL, CSA, CCC
Protective treatment	Standard version	"TC"
Ambient air temperature	Operation	- 25...+70 °C (-13...+158 °F)
	Storage	- 40...+70 °C (-40...+158 °F)
Vibration resistance	Conforming to IEC 60068-2-6	25 gn (10...500 Hz) except switch with head ZCE 24: 20 gn
Shock resistance	Conforming to IEC 60068-2-27	50 gn (11 ms) except heads ZCE08: 15 gn (11 ms) and ZCE24: 30 gn (18 ms)
Electric shock protection		Class II conforming to IEC 61140 and NF C 20-030 for XCKP and XCKT
		Class I conforming to IEC 61140 and NF C 20-030 for XCKD
Degree of protection		IP 66 and IP 67 conforming to IEC 60529; IK 04 conforming to EN 50102 for XCKP and XCKT, IK 06 conforming to EN 50102 for XCKD
Repeat accuracy		0.1 mm on the tripping points, with 1 million operating cycles for head with end plunger
Cable entry or integral connector	Depending on model	Either: tapped entry for PG 11 or PG 13 conduit thread, tapped ISO M16 x 1.5 or ISO M20 x 1.5, tapped 1/2" NPT, tapped PF 1/2 (G1/2) or integral M12 connector
Materials		XCKD : Zamak® bodies and heads, XCKP and XCKT : plastic bodies, Zamak heads

Limit Switches

Osiswitch® Compact

Universal, XCKP and XCKT Plastic / XCKD Metal

Contact block characteristics	
Rated operational characteristics	XE2•P ~ AC-15; A300 (Ue = 240 V, Ie = 3 A); Ithe = 10 A ≡ DC-13; Q300 (Ue = 250 V, Ie = 0.27 A), conforming to IEC 60947-5-1 Appendix A, EN 60947-5-1
	XE3•P ~ AC-15; B300 (Ue = 240 V, Ie = 1.5 A); Ithe = 6 A ≡ DC-13; R300 (Ue = 250 V, Ie = 0.1 A), conforming to IEC 60947-5-1 Appendix A, EN 60947-5-1
Rated insulation voltage	XE2•P Ui = 500 V degree of pollution 3 conforming to IEC 60947-1 Ui = 300 V conforming to UL 508, CSA C22-2 n° 14
	XE3•P Ui = 400 V degree of pollution 3 conforming to IEC 60947-1 Ui = 300 V conforming to UL 508, CSA C22-2 n° 14
Rated impulse withstand voltage	XE2•P U imp = 6 kV conforming to IEC 60947-1, IEC 60664
	XE3•P U imp = 4 kV conforming to IEC 60947-1, IEC 60664
Positive operation (depending on model)	N/C contacts with positive opening operation conforming to IEC 60 947-5-1 Appendix K, EN 60947-5-1
Resistance across terminals	≤ 25 mΩ conforming to IEC 60255-7 category 3
Short-circuit protection	XE2•P 10 A cartridge fuse type gG (gl)
	XE3•P 6 A cartridge fuse type gG (gl)
Cabling (screw clamp terminals)	XE2SP•151 and XE2SP2141 Clamping capacity, min: 1 x 0.34 mm ² , max: 2 x 1.5 mm ²
	XE2NP21•1 and XE2NP31•1 Clamping capacity, min: 1 x 0.5 mm ² , max: 2 x 2.5 mm ²
	XE3NP and XE3SP Clamping capacity, min: 1 x 0.34 mm ² , max: 1 x 1 mm ² or 2 x 0.75 mm ²
Minimum actuation speed (for head with end plunger)	XE2SP•151, XE2SP2141 and XE3SP: 0.01 m/minute (0.03 ft/minute)
	XE2NP21•1, XE2NP31•1 and XE3NP: 6 m/minute (19.68 ft/minute)
Electrical durability	<ul style="list-style-type: none"> Conforming to IEC 60947-5-1 Appendix C Utilization categories AC-15 and DC-13 Maximum operating rate: 3600 operating cycles/hour Load factor: 0.5

XE2SP•151, XE2SP2141	XE2NP21•1, XE2NP31•1
----------------------	----------------------

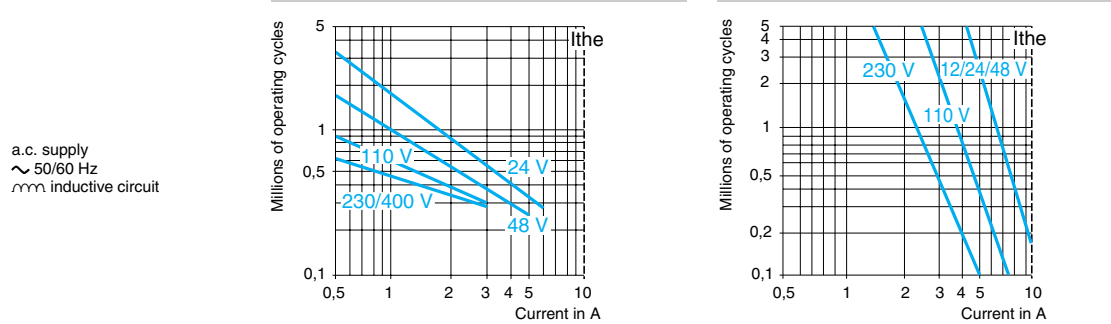

d.c. supply ≡	Power switched in W for 5 million operating cycles.				
	Voltage	V	24	48	120
~	W	10	7	4	

d.c. supply ≡	Power switched in W for 5 million operating cycles.				
	Voltage	V	24	48	120
~	W	13	9	7	

For XE2SP•151 on ~ or ≡, N/C and N/O contacts simultaneously loaded to the values shown with reverse polarity.

XE3NP••••	XE3SP••••
-----------	-----------

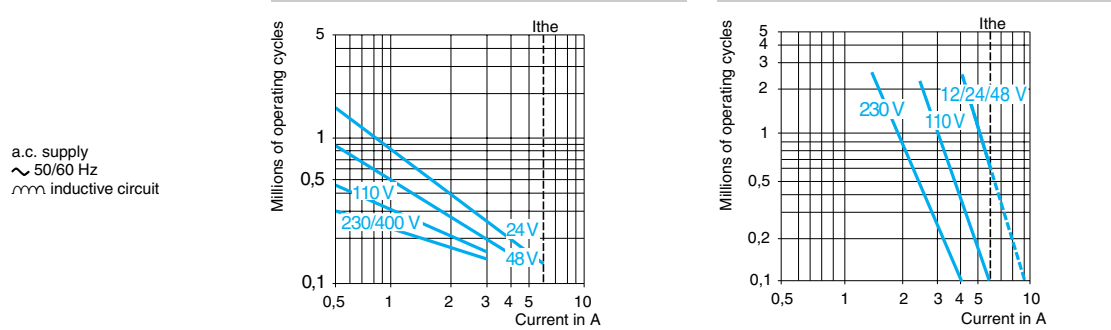

d.c. supply ≡	Power switched in W for 5 million operating cycles.				
	Voltage	V	24	48	120
~	W	3	2	1	

d.c. supply ≡	Power switched in W for 5 million operating cycles.				
	Voltage	V	24	48	120
~	W	4	3	2	

Limit Switches

Osiswitch® Compact, Metal

Universal, XCKD—Complete Units with 1/2" NPT Cable Entry

Type of head	Plunger (mounting by the body)					
	Form B (1)		Form C (1)		Form E (1)	
Type of operator	Metal end plunger	Metal end plunger with elastomer boot	Steel roller plunger	Thermoplastic roller lever plunger, horizontal actuation in 1 direction	Thermoplastic roller lever plunger, vertical actuation in 1 direction	Thermoplastic roller lever plunger, horiz. or vert. actuation in 1 direction
Catalog Numbers (2) (3)						
	2-pole N/C + N/O snap action (XE2S P2151)	XCKD2110N12 	XCKD2111N12 	XCKD2102N12 	XCKD2121N12 	XCKD2127N12
	2-pole N/C + N/O break before make, slow break (XE2N P2151)	XCKD2510N12 	XCKD2511N12 	XCKD2502N12 	XCKD2521N12 	XCKD2527N12
	2-pole N/C + N/C snap action (XE2S P2141)	ZCD29 + ZCDEN12 + ZCE10 	ZCD29 + ZCDEN12 + ZCE11 	ZCD29 + ZCDEN12 + ZCE02 	ZCD29 + ZCDEN12 + ZCE21 	ZCD29 + ZCDEN12 + ZCE27
	2-pole N/C + N/C simultaneous, slow break (XE2N P2141)	ZCD27 + ZCDEN12 + ZCE10 	ZCD27 + ZCDEN12 + ZCE11 	ZCD27 + ZCDEN12 + ZCE02 	ZCD27 + ZCDEN12 + ZCE21 	ZCD27 + ZCDEN12 + ZCE27
	3-pole N/C + N/C + N/O snap action (XE3SP2141)	ZCD39 + ZCDEN12 + ZCE10 	ZCD39 + ZCDEN12 + ZCE11 	ZCD39 + ZCDEN12 + ZCE02 	ZCD39 + ZCDEN12 + ZCE21 	ZCD39 + ZCDEN12 + ZCE27
	3-pole N/C + N/C + N/O break before make, slow break (XE3N P2141)	ZCD37 + ZCDEN12 + ZCE10 	ZCD37 + ZCDEN12 + ZCE11 	ZCD37 + ZCDEN12 + ZCE02 	ZCD37 + ZCDEN12 + ZCE21 	ZCD37 + ZCDEN12 + ZCE27
Weight, kg (lb)	0.180 (0.397)	0.180 (0.397)	0.185 (0.408)	0.195 (0.430)	0.190 (0.419)	0.195 (0.430)
Contact operation	contact closed contact open		(A)(B) = cam displacement (P) = positive opening point		N/C contact with positive opening operation, when properly mounted and using a conforming operator	
Characteristics						
Switch actuation	On end			By 30° cam		
Type of actuation						
Maximum actuation speed	0.5 m/s (1.64 ft/s)			1 m/s (3.28 ft/s)		
Minimum force or torque	For tripping		15 N (3.37 lb)		12 N (2.70 lb)	
	For positive opening		45 N (10.12 lb)		36 N (8.09 lb)	
For positive opening					18 N (4.05 lb)	
Cam entry (3)	1 entry tapped M16 x 1.5 mm for ISO cable entry, clamping capacity 4 to 8 mm (0.16 to 0.31 in.)					

1. Form conforming to EN 50047. See page 22.
 2. Switches with gold contacts or ring type connections: please consult your local sales office.
 3. For an entry tapped for a PG 11 conduit thread, replace N12 in the catalog number with G11. Examples: XCKD2110N12 becomes XCKD2110G11, ZCDEN12 becomes ZCDEG11.

Limit Switches

Osiswitch® Compact, Metal

Universal, XCKD—Complete Units with 1/2" NPT Cable Entry

Type of head	Plunger (mounting by the head)		Rotary (mounting by the body) Form A (1)				Multi-directional
Type of operator	M18 with metal end plunger	M18 with steel roller plunger	Thermoplastic roller lever	Variable length thermoplastic roller lever	Thermoplastic roller lever, Ø 50 mm (1.97 in.)	Variable length thermoplastic roller lever, Ø 50 mm (1.97 in.)	Cat's whisker (3)
Catalog Numbers (2) (4)							
	XCKD21H0N12 2-pole N/C + N/O snap action (XE2S P2151) 	XCKD21H2N12 	XCKD2118N12 	XCKD2145N12 	XCKD2139N12 	XCKD2149N12 	XCKD2106N12
	XCKD25H0N12 2-pole N/C + N/O break before make, slow break (XE2N P2151) 	XCKD25H2N12 	XCKD2518N12 	XCKD2545N12 	XCKD2539N12 	XCKD2549N12 	XCKD2506N12
	ZCD29 + ZCDEN12 + ZCEH0 2-pole N/C + N/C snap action (XE2S P2141) 	ZCD29 + ZCDEN12 + ZCEH2 	ZCD29 + ZCDEN12 + ZCE01 + ZCY18 	ZCD29 + ZCDEN12 + ZCE01 + ZCY45 	ZCD29 + ZCDEN12 + ZCE01 + ZCY39 	ZCD29 + ZCDEN12 + ZCE01 + ZCY49 	ZCD29 + ZCDEN12 + ZCE06
	ZCD27 + ZCDEN12 + ZCEH0 2-pole N/C + N/C simultaneous, slow break (XE2N P2141) 	ZCD27 + ZCDEN12 + ZCEH2 	ZCD27 + ZCDEN12 + ZCE01 + ZCY18 	ZCD27 + ZCDEN12 + ZCE01 + ZCY45 	ZCD27 + ZCDEN12 + ZCE01 + ZCY39 	ZCD27 + ZCDEN12 + ZCE01 + ZCY49 	ZCD27 + ZCDEN12 + ZCE06
	ZCD39 + ZCDEN12 + ZCEH0 3-pole N/C + N/C + N/O snap action (XE3S P2141) 	ZCD39 + ZCDEN12 + ZCEH2 	ZCD39 + ZCDEN12 + ZCE01 + ZCY18 	ZCD39 + ZCDEN12 + ZCE01 + ZCY45 	ZCD39 + ZCDEN12 + ZCE01 + ZCY39 	ZCD39 + ZCDEN12 + ZCE01 + ZCY49 	ZCD39 + ZCDEN12 + ZCE06
	ZCD37 + ZCDEN12 + ZCEH0 3-pole N/C + N/C + N/O break before make, slow break (XE3N P2141) 	ZCD37 + ZCDEN12 + ZCEH2 	ZCD37 + ZCDEN12 + ZCE01 + ZCY18 	ZCD37 + ZCDEN12 + ZCE01 + ZCY45 	ZCD37 + ZCDEN12 + ZCE01 + ZCY39 	ZCD37 + ZCDEN12 + ZCE01 + ZCY49 	ZCD37 + ZCDEN12 + ZCE06
Weight, kg (lb)	0.220 (0.485)	0.220 (0.485)	0.225 (0.496)	0.235 (0.518)	0.235 (0.518)	0.245 (0.540)	0.175 (0.386)
Contact operation	contact closed contact open		(A) = cam displacement (P) = positive opening point		N/C contact with positive opening operation, when properly mounted and using a conforming operator		
Characteristics							
Switch actuation	On end		By 30° cam				By any moving part
Type of actuation							
Maximum actuation speed	0.5 m/s (1.64 ft/s)		1.5 m/s (4.92 ft/s)				1 m/s (3.28 ft/s), any direction
Minimum force or torque	For tripping	15 N (3.37 lb)	10 N (2.25 lb)	0.1 N•m (0.89 lb-in)			0.13 N•m (1.15 lb-in)
	For positive opening	45 N (10.12 lb)	36 N (8.09 lb)	0.25 N•m (2.21 lb-in)			—
Cable entry (4)	1 entry tapped M16 x 1.5 mm for ISO cable entry, clamping capacity 4 to 8 mm (0.16 to 0.31 in.)						

- Form conforming to EN 50047. See page 22.
- Switches with gold contacts or ring type connections: please consult your local sales office.
- Value taken with actuation by moving part at 100 mm (3.94 in.) from the mountings.
- For an entry tapped for a PG 11 conduit thread, replace N12 in the catalog number with **G11**. Examples: XCKD21H0N12 becomes **XCKD21H0G11**, ZCDEN12 becomes **ZCDEG11**.

Note: For more information, consult pages 63, 70–71.

Limit Switches

Osiswitch® Compact, Metal

Universal, XCKD—Complete Units with 1/2" NPT Cable Entry

ZCD2• + ZCDEN12 / ZCD3• + ZCDEN12

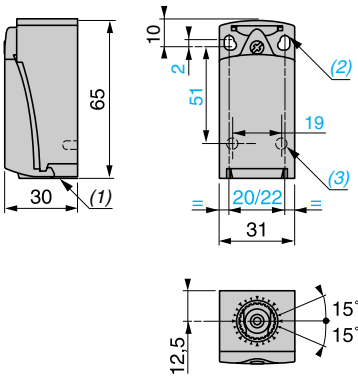

ZCE10

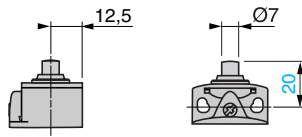

ZCE11

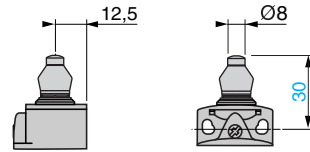

ZCE02

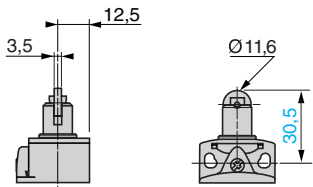

ZCE21

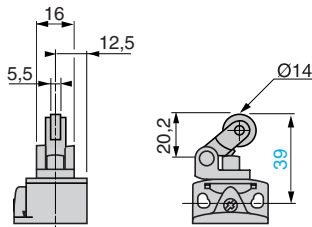

ZCE27

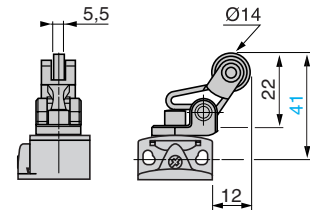

ZCE28

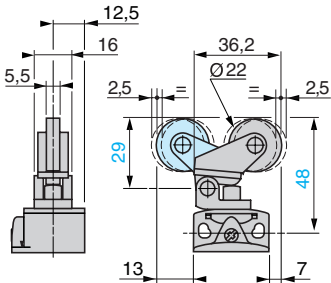

ZCEH0

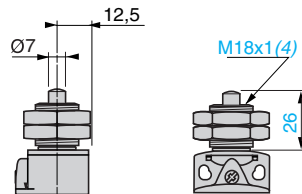

ZCEH2

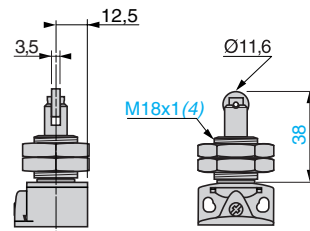

1. Tapped entry for ISO M16 x 1.5 or PG 11 conduit thread.
2. 2 elongated holes Ø 4.3 x 6.3 mm (0.17 x 0.25 in.) on 22 mm (0.87 in.) centers, 2 holes Ø 4.3 mm (0.17 in.) on 20 mm (0.79 in.) centers.
3. 2 x Ø 3 holes for support studs, depth 4 mm (0.16 in.).
4. Mounting nut thickness 3.5 mm (0.14 in.).

Limit Switches
Osiswitch® Compact, Metal
Universal, XCKD—Complete Units with 1/2" NPT Cable Entry

ZCE01 + ZCY18

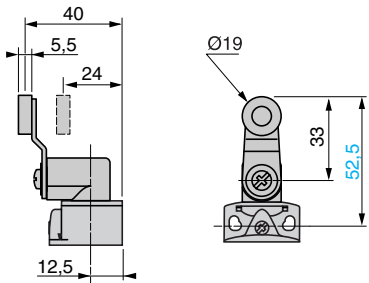

ZCE01 + ZCY45

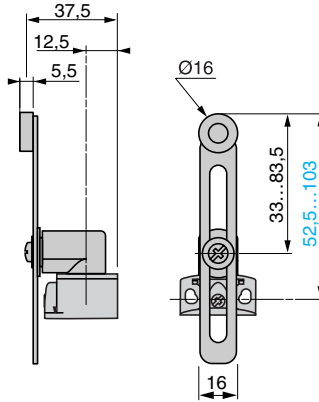

ZCE01 + ZCY39

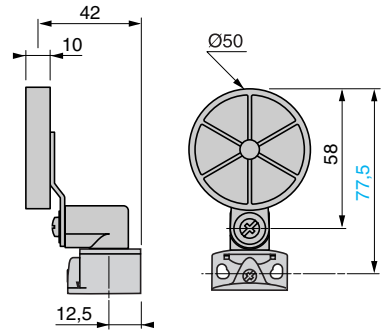

ZCE01 + ZCY49

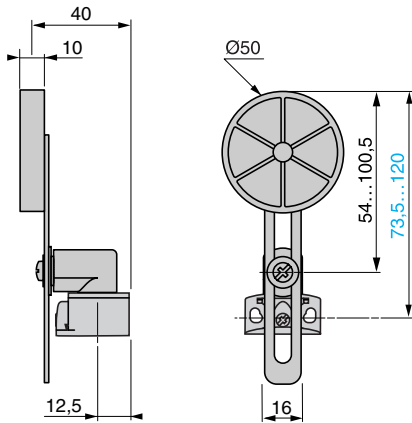

ZCE06

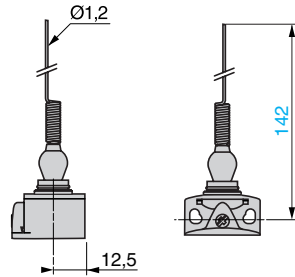

Limit Switches

Osiswitch® Compact, Metal

Universal, XCKD—Integral M12 Connector

Type of head	Plunger (mounting by the body)					
	Form B (1)		Form C (1)		Form E (1)	
Type of operator	Metal end plunger	Metal end plunger with elastomer boot	Steel roller plunger	Thermoplastic roller lever plunger, horizontal actuation in 1 direction	Thermoplastic roller lever plunger, vertical actuation in 1 direction	Thermoplastic roller lever plunger, horiz. or vert. actuation in 1 direction
Catalog Numbers						
2-pole N/C + N/O snap action (XE2S P2151)	 XCKD2110M12	 XCKD2111M12	 XCKD2102M12	 XCKD2121M12	 XCKD2127M12	 XCKD2128M12
2-pole N/C + N/C snap action (XE2S P2141)	 ZCD29M12 + ZCE10	 ZCD29M12 + ZCE11	 ZCD29M12 + ZCE02	 ZCD29M12 + ZCE21	 ZCD29M12 + ZCE27	 ZCD29M12 + ZCE28
Weight, kg (lb)	0.190 (0.419)	0.190 (0.419)	0.195 (0.430)	0.205 (0.452)	0.200 (0.441)	0.205 (0.452)
Contact operation	contact closed contact open		(A) (B) = cam displacement (P) = positive opening point			

1. Form conforming to EN 50047. See page 22.

Characteristics

Switch actuation	On end	By 30° cam				
Type of actuation						
Maximum actuation speed	0.5 m/s (1.64 ft/s)	1 m/s (3.28 ft/s)				
Minimum force or torque	For tripping	15 N (3.37 lb)	12 N (2.70 lb)	6 N (1.35 lb)		
	For positive opening	45 N (10.12 lb)	36 N (8.09 lb)	18 N (4.05 lb)		
Connection	M12 5-pin connector, U _i = 60 V, I _e = 4 A maximum, I _{th} = 4 A					

Connections

Integral M12 connector

	XE2SP2151 1-2: N/C 3-4: N/O 5: ↓	XE2SP2141 1-2: N/C 3-4: N/C 5: ↓
--	--	--

Dimensions

ZCD2-M12	ZCE10	ZCE11	ZCE02	ZCE21

- 2 elongated holes $\varnothing 4.3 \times 6.3$ mm (0.17 x 0.25 in.) on 22 mm (0.87 in.) centers, 2 holes $\varnothing 4.3$ mm (0.17 in.) on 20 mm (0.79 in.) centers.
- 2 x $\varnothing 3$ holes for support studs, depth 4 mm (0.16 in.).
- Mounting nut thickness 3.5 mm (0.14 in.).

Limit Switches

Osiswitch® Compact, Metal

Universal, XCKD—Integral M12 Connector

Type of head	Plunger (mounting by the head)		Rotary (mounting by the body) Form A (1)				Multi-directional
Type of operator	M18 with metal end plunger	M18 with steel roller plunger	Thermoplastic roller lever	Variable length thermoplastic roller lever	Thermoplastic roller lever, Ø 50 mm (1.97 in.)	Variable length thermoplastic roller lever, Ø 50 mm (1.97 in.)	Cat's whisker (2)
Catalog Numbers							
2-pole N/C + N/O snap action (XE2S P2151)	XCKD21H0M12 	XCKD21H2M12 	XCKD2118M12 	XCKD2145M12 	XCKD2139M12 	XCKD2149M12 	XCKD2106M12
2-pole N/C + N/C snap action (XE2S P2141)	ZCD29M12 + ZCEH0 	ZCD29M12 + ZCEH2 	ZCD29M12 + ZCE01 + ZCY18 	ZCD29M12 + ZCE01 + ZCY45 	ZCD29M12 + ZCE01 + ZCY39 	ZCD29M12 + ZCE01 + ZCY49 	ZCD29M12 + ZCE06
Weight, kg (lb)	0.235 (0.518)	0.235 (0.518)	0.220 (0.485)	0.220 (0.485)	0.220 (0.485)	0.220 (0.485)	0.185 (0.408)
Contact operation	contact closed contact open		(A) = cam displacement (P) = positive opening point				

- Form conforming to EN 50047. See page 22.
- Value taken with actuation by moving part at 100 mm (3.94 in.) from the mounting.

Characteristics

Switch actuation	On end	By 30° cam			By any moving part
Type of actuation					
Maximum actuation speed	0.5 m/s (1.64 ft/s)	1.5 m/s (4.92 ft/s)			1 m/s (3.28 ft/s), any direction
Minimum force or torque	For tripping: 15 N (3.37 lb) For positive opening: 45 N (10.12 lb)	10 N (2.25 lb)	10 N (2.25 lb)	0.1 N•m (0.89 lb-in)	0.13 N•m (1.15 lb-in)
Connection	M12 5-pin connector, U _i = 60 V, I _e = 4 A maximum, I _{th} = 4 A				

Dimensions

ZCE01 + ZCY18	ZCE01 + ZCY45	ZCE01 + ZCY39	ZCE01 + ZCY49	ZCE06
ZCEH2				

3. Mounting nut thickness 3.5 mm (0.14 in.)

Limit Switches

Osiswitch® Compact, Plastic

Universal, XCKP—Complete Units with 1/2" NPT Cable Entry

Type of head	Plunger (mounting by the body)					
	Form B (1)		Form C (1)		Form E (1)	
Type of operator	Metal end plunger	Metal end plunger with elastomer boot	Steel roller plunger	Thermoplastic roller lever plunger, horizontal actuation in 1 direction	Thermoplastic roller lever plunger, vertical actuation in 1 direction	Thermoplastic roller lever plunger, horiz. or vert. actuation in 1 direction
Catalog Numbers (2) (3)						
 2-pole N/C + N/O snap action (XE2S P2151)	XCKP2110N12 	XCKP2111N12 	XCKP2102N12 	XCKP2121N12 	XCKP2127N12 	XCKP2128N12
 2-pole N/C + N/O break before make, slow break (XE2N P2151)	XCKP2510N12 	XCKP2511N12 	XCKP2502N12 	XCKP2521N12 	XCKP2527N12 	XCKP2528N12
 2-pole N/C + N/C snap action (XE2S P2141)	ZCP29 + ZCPEN12 + ZCE10 	ZCP29 + ZCPEN12 + ZCE11 	ZCP29 + ZCPEN12 + ZCE02 	ZCP29 + ZCPEN12 + ZCE21 	ZCP29 + ZCPEN12 + ZCE27 	ZCP29 + ZCPEN12 + ZCE28
 2-pole N/C + N/C simultaneous, slow break (XE2N P2141)	ZCP27 + ZCPEN12 + ZCE10 	ZCP27 + ZCPEN12 + ZCE11 	ZCP27 + ZCPEN12 + ZCE02 	ZCP27 + ZCPEN12 + ZCE21 	ZCP27 + ZCPEN12 + ZCE27 	ZCP27 + ZCPEN12 + ZCE28
 3-pole N/C + N/C + N/O snap action (XE3S P2141)	ZCP39 + ZCPEN12 + ZCE10 	ZCP39 + ZCPEN12 + ZCE11 	ZCP39 + ZCPEN12 + ZCE02 	ZCP39 + ZCPEN12 + ZCE21 	ZCP39 + ZCPEN12 + ZCE27 	ZCP39 + ZCPEN12 + ZCE28
 3-pole N/C + N/C + N/O break before make, slow break (XE3N P2141)	ZCP37 + ZCPEN12 + ZCE10 	ZCP37 + ZCPEN12 + ZCE11 	ZCP37 + ZCPEN12 + ZCE02 	ZCP37 + ZCPEN12 + ZCE21 	ZCP37 + ZCPEN12 + ZCE27 	ZCP37 + ZCPEN12 + ZCE28
Weight, kg (lb)	0.090 (0.198)	0.090 (0.198)	0.095 (0.209)	0.105 (0.231)	0.100 (0.220)	0.105 (0.231)
Contact operation			(A)(B) = cam displacement (P) = positive opening point			
Characteristics						
Switch actuation	On end		By 30° cam			
Type of actuation						
Maximum actuation speed	0.5 m/s (1.64 ft/s)			1 m/s (3.28 ft/s)		
Minimum force or torque	For tripping 45 N (10.12 lb)		12 N (2.70 lb)		6 N (1.35 lb)	
	For positive opening 45 N (10.12 lb)		36 N (8.09 lb)		18 N (4.05 lb)	
Cable entry (3)	1 entry tapped M16 x 1.5 mm for ISO cable entry, clamping capacity 4 to 8 mm (0.16 to 0.31 in.)					

- Form conforming to EN 50047. See page 22.
 - Switches with gold contacts or ring type connections: please consult your local sales office.
 - For an entry tapped for a PG 11 conduit thread, replace N12 in the catalog number with G11. Examples: XCKP2110N12 becomes XCKP2110G11, ZCPEN12 becomes ZCPEG11.
- Note:** For more information, consult pages 63, 70–71.

Limit Switches

Osiswitch® Compact, Plastic

Universal, XCKP—Complete Units with 1/2" NPT Cable Entry

Type of head	Plunger (mounting by the head)		Rotary (mounting by the body)				Multi-directional
			Form A (1)				
Type of operator	M18 with metal end plunger	M18 with steel roller plunger	Thermoplastic roller lever	Variable length thermoplastic roller lever	Thermoplastic roller lever, Ø 50 mm (1.97 in.)	Variable length thermoplastic roller lever, Ø 50 mm (1.97 in.)	Cat's whisker (4)
Catalog Numbers (2)	XCKP21H0N12	XCKP21H2N12	XCKP2118N12	XCKP2145N12	XCKP2139N12	XCKP2149N12	XCKP2106N12
	2-pole N/C + N/O snap action (XE2S P2151)		2-pole N/C + N/O snap action (XE2SP2141)	2-pole N/C + N/C simultaneous, slow break (XE2NP2141)	3-pole N/C + N/C + N/O snap action (XE3SP2141)	3-pole N/C + N/C + N/O break before make, slow break (XE3NP2141)	
Weight, kg (lb)	0.130 (0.287)	0.130 (0.287)	0.135 (0.298)	0.145 (0.320)	0.145 (0.320)	0.155 (0.342)	0.085 (0.187)
Contact operation			(A) = cam displacement (P) = positive opening point		⊕ N/C contact with positive opening operation, when properly mounted and using a conforming operator		
Characteristics							
Switch actuation	On end	By 30° cam				By any moving part	
Type of actuation							
Maximum actuation speed	0.5 m/s (1.64 ft/s)		1.5 m/s (4.92 ft/s)				1 m/s (3.28 ft/s), any direction
Minimum force or torque	For tripping	15 N (3.37 lb)	10 N (2.25 lb)	0.1 N•m (0.89 lb-in)			0.13 N•m (1.15 lb-in)
	For positive opening	45 N (10.12 lb)	36 N (8.09 lb)	0.25 N•m (2.21 lb-in)			—
Cable entry (3)	1 entry tapped M16 x 1.5 mm for ISO cable entry, clamping capacity 4 to 8 mm (0.16 to 0.31 in.)						

- Form conforming to EN 50047. See page 22.
 - Switches with gold contacts or ring type connections: please consult your local sales office.
 - For an entry tapped for a PG 11 conduit thread, replace N12 in the catalog number with G11. Examples: XCKP21H0N12 becomes XCKP21H0G11, ZCPEN12 becomes ZCPEG11.
 - Value taken with actuation by moving part at 100 mm (3.94 in.) from the mountings.
- Note:** For more information, consult pages 63, 70–71.

Limit Switches

Osiswitch® Compact, Plastic

Universal, XCKP—Complete Units with 1/2" NPT Cable Entry

ZCP2• + ZCPEN12 / ZCP3• + ZCPEN12

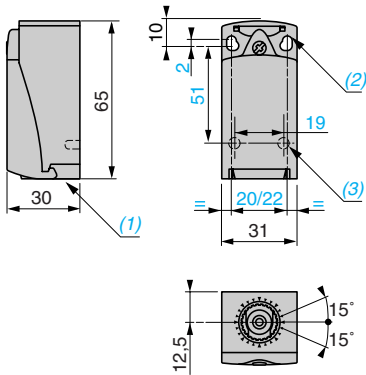

ZCE10

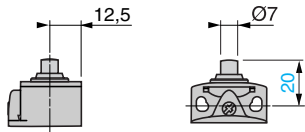

ZCE11

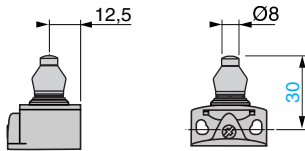

ZCE28

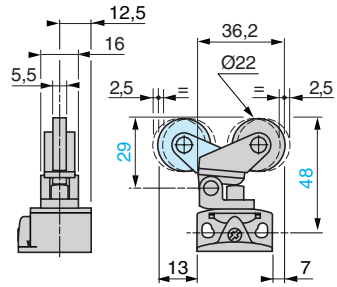

ZCE02

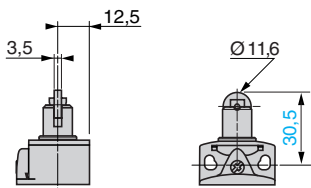

ZCE21

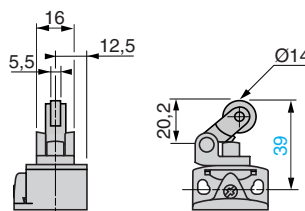

ZCE27

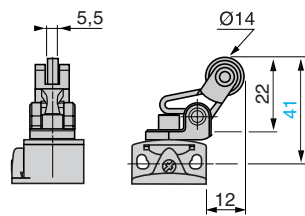

ZCE06

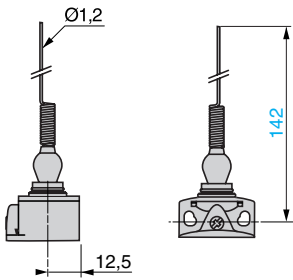

ZCEH0

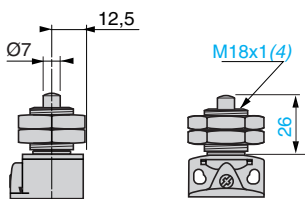

ZCE01 + ZCY18

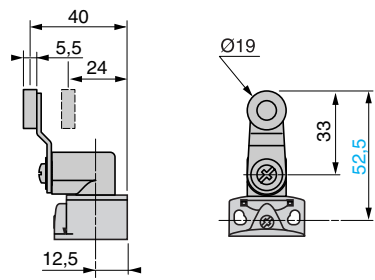

ZCEH2

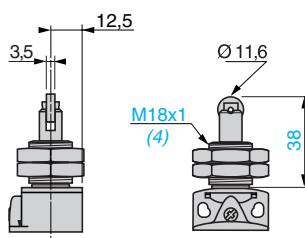

ZCE01 + ZCY45

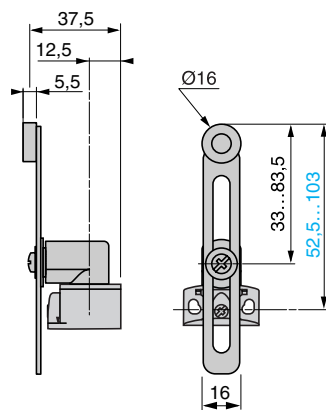

ZCE01 + ZCY49

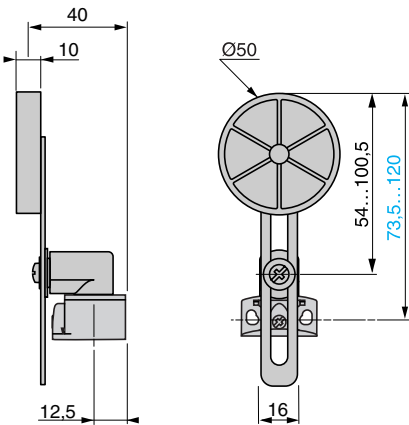

ZCE01 + ZCY39

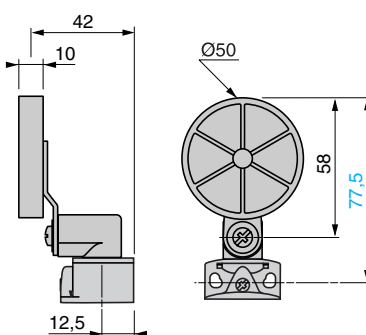

1. Tapped entry for ISO M16 x 1.5 or PG 11 conduit thread.
2. 2 elongated holes $\varnothing 4.3 \times 6.3$ mm (0.17 x 0.25 in.) on 22 mm (0.87 in.) centers, 2 holes $\varnothing 4.3$ mm (0.17 in.) on 20 mm (0.79 in.) centers.

3. 2 x $\varnothing 3$ holes for support studs, depth 4 mm (0.16 in.).
4. Mounting nut thickness 3.5 mm (0.14 in.).

Limit Switches

Osiswitch® Compact, Metal and Plastic Universal, XCKD, XCKP, and XCKT

Catalog Number Interpretation

For Interpretation of the Catalog Number Only

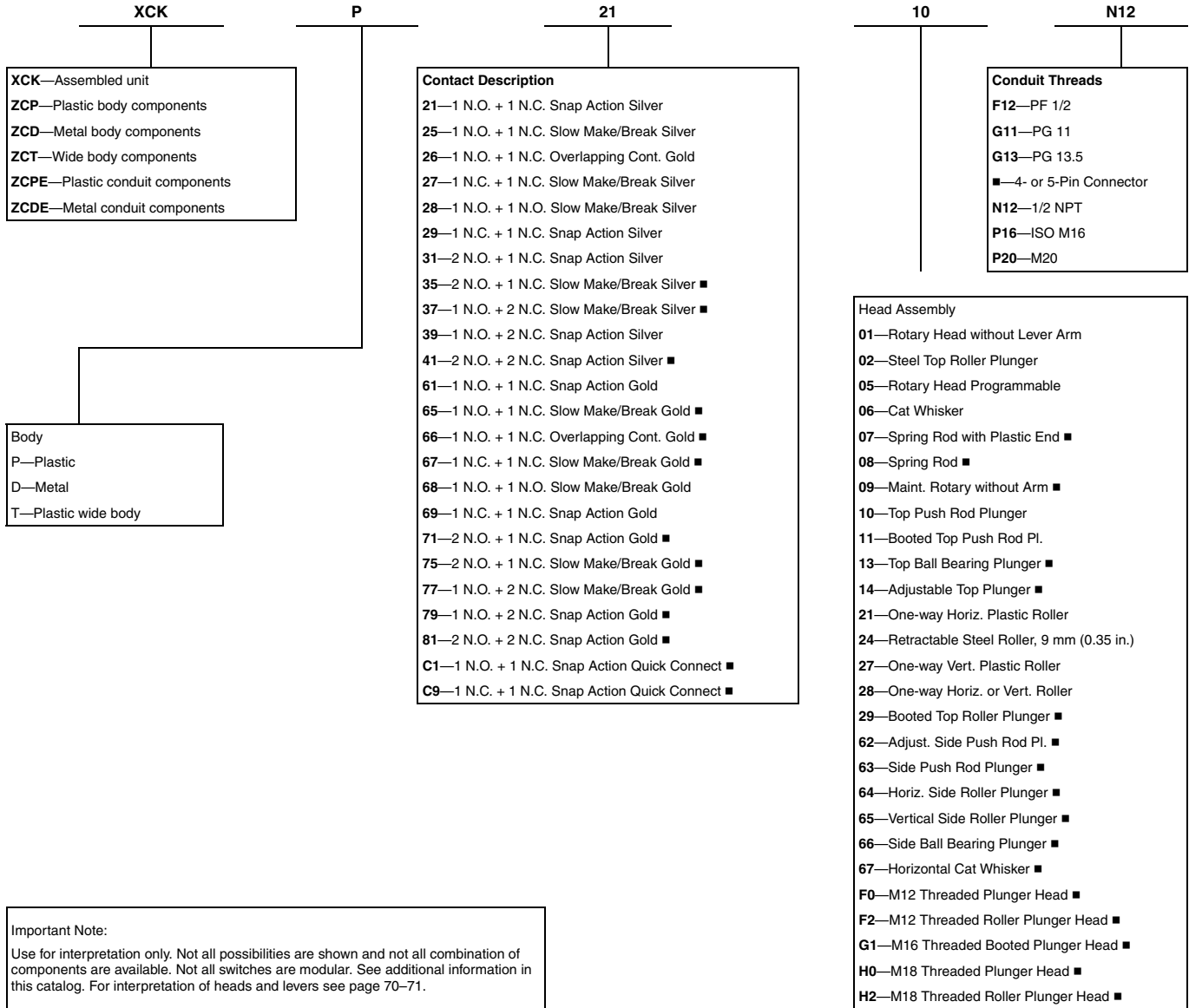

Limit Switches

Osiswitch® Compact, Plastic

Universal, XCKP—Integral M12 Connector

Type of head	Plunger (mounting by the body)					
	Form B (1)		Form C (1)	Form E (1)		
Type of operator	Metal end plunger	Metal end plunger with elastomer boot	Steel roller plunger	Thermoplastic roller lever plunger, horizontal actuation in 1 direction	Thermoplastic roller lever plunger, vertical actuation in 1 direction	Thermoplastic roller lever plunger, horiz. or vert. actuation in 1 direction
Catalog Numbers						
2-pole N/C + N/O snap action (XE2S P2151)	XCKP2110M12	XCKP2111M12	XCKP2102M12	XCKP2121M12	XCKP2127M12	XCKP2128M12
2-pole N/C + N/C snap action (XE2S P2141)	ZCP29M12 + ZCE10	ZCP29M12 + ZCE11	ZCP29M12 + ZCE02	ZCP29M12 + ZCE21	ZCP29M12 + ZCE27	ZCP29M12 + ZCE28
Weight, kg (lb)	0.100 (0.220)	0.100 (0.220)	0.100 (0.220)	0.110 (0.243)	0.110 (0.243)	0.110 (0.243)
Contact operation			(A)(B) = cam displacement (P) = positive opening point		⊖ N/C contact with positive opening operation, when properly mounted and using a conforming operator	

1. Form conforming to EN 50047. See page 22.

Characteristics

Switch actuation	On end	By 30° cam				
Type of actuation						
Maximum actuation speed	0.5 m/s (1.64 ft/s)			1 m/s (3.28 ft/s)		
Minimum force or torque	For tripping	15 N (3.37 lb)	12 N (2.70 lb)	6 N (1.35 lb)		
	For positive opening	45 N (10.12 lb)	36 N (8.09 lb)	18 N (4.05 lb)		
Connection	M12 4-pin connector, Ui = 250 V, Ie = 3 A maximum, Ith = 3 A					

Connections

Integral M12 connector

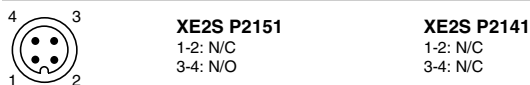

Dimensions

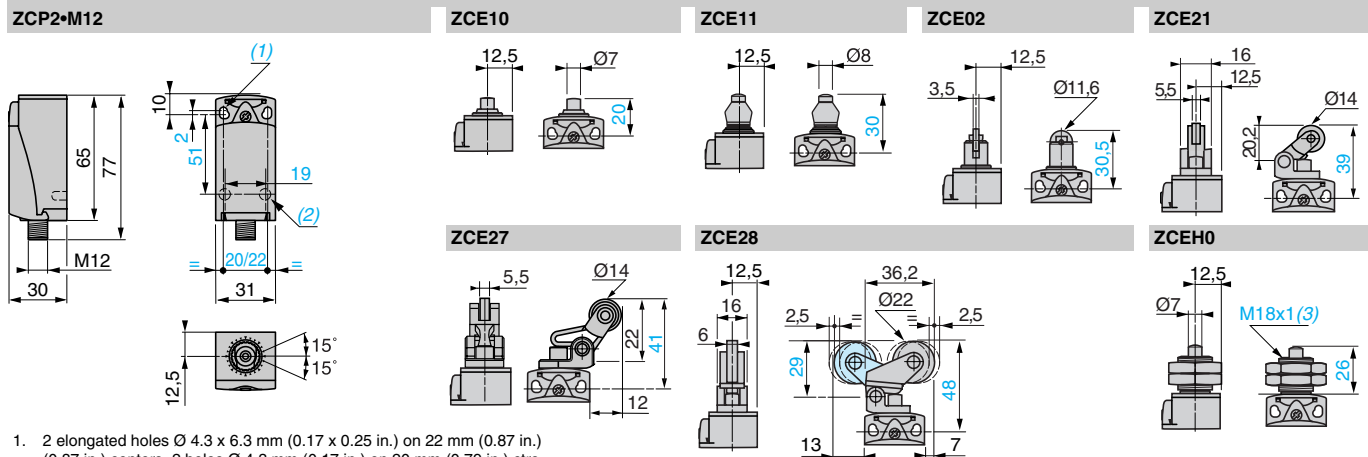

- 2 elongated holes $\text{Ø} 4.3 \times 6.3 \text{ mm}$ (0.17 x 0.25 in.) on 22 mm (0.87 in.) centers, 2 holes $\text{Ø} 4.3 \text{ mm}$ (0.17 in.) on 20 mm (0.79 in.) ctrs.
- 2 x $\text{Ø} 3 \text{ mm}$ (0.12 in.) holes for support studs, depth 4 mm (0.16 in.).
- Mounting nut thickness 3.5 mm (0.14 in.).

Limit Switches

Limit Switches

Osiswitch® Compact, Plastic

Universal, XCKP—Integral M12 Connector

Type of head	Plunger (mounting by the head)		Rotary (mounting by the body)				Multi-directional
			Form A (1)				
Type of operator	M18 with metal end plunger	M18 with steel roller plunger	Thermoplastic roller lever	Variable length thermoplastic roller lever	Thermoplastic roller lever, Ø 50 mm (1.97 in.)	Variable length thermoplastic roller lever, Ø 50 mm (1.97 in.)	Cat's whisker (2)
Catalog Numbers							
2-pole N/C + N/O snap action (XE2SP2151)	XCKP21H0M12 	XCKP21H2M12 	XCKP2118M126 	XCKP2145M12 	XCKP2139M12 	XCKP2149M12 	XCKP2106M126
2-pole N/C + N/C snap action (XE2S P2141)	ZCP29M12 + ZCEH0 	ZCP29M12 + ZCEH2 	ZCP29M12 + ZCE01 + ZCY18 	ZCP29M12 + ZCE01 + ZCY45 	ZCP29M12 + ZCE01 + ZCY49 	ZCP29M12 + ZCE01 + ZCY49 	ZCP29M12 + ZCE06
Weight, kg (lb)	0.140 (0.309)	0.140 (0.309)	0.140 (0.309)	0.150 (0.331)	0.155 (0.342)	0.160 (0.353)	0.090 (0.198)
Contact operation	contact closed contact open		(A) = cam displacement (P) = positive opening point	☉ N/C contact with positive opening operation, when properly mounted and using a conforming operator			

- Form conforming to EN 50047. See page 22.
- Value taken with actuation by moving part at 100 mm (3.94 in.) from the mountings.

Characteristics

Switch actuation	On end	By 30° cam	By any moving part	
Type of actuation				
Maximum actuation speed	0.5 m/s (1.64 ft/s)		1.5 m/s (4.92 ft/s)	
Minimum force or torque	For tripping: 15 N (3.37 lb) For positive opening: 45 N (10.12 lb)	10 N (2.25 lb) 36 N (8.09 lb)	0.1 N•m (0.89 lb-in) 0.25 N•m (2.21 lb-in)	
Connection	M12 4-pin connector, U _i = 250 V, I _e = 3 A maximum, I _{th} = 3 A			











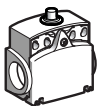



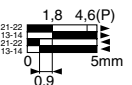

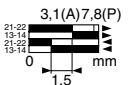
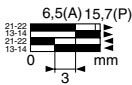

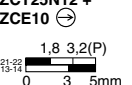
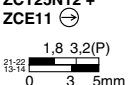
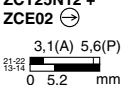
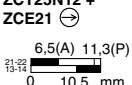

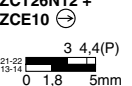
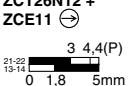
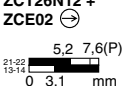
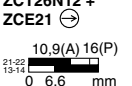
Dimensions

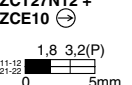
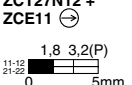
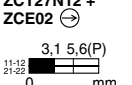
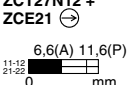
ZCE01 + ZCY18	ZCE01 + ZCY45	ZCE01 + ZCY39	ZCE01 + ZCY49	ZCE06
				ZCEH2
				3. Mounting nut thickness 3.5 mm (0.14 in.)

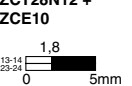
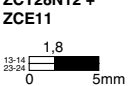
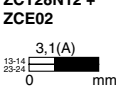
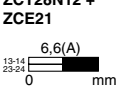
Limit Switches

Osiswitch® Compact, Plastic

Universal, XCKT—Complete Units with Two Cable Entries and 1/2" NPT Adapter

Type of head	Plunger (mounting by the body)			Multi-directional
	Form B (1)	Form C (1)	Form E (1)	
				
Type of operator	Metal end plunger	Metal end plunger with elastomer boot	Steel roller plunger	Thermoplastic roller lever plunger, horizontal actuation in 1 direction
Catalog Numbers (2) (3)				
 2-pole N/C + N/O snap action (XE2SP3151)	XCKT2110N12 ⊖ 	XCKT2111N12 ⊖ 	XCKT2102N12 ⊖ 	XCKT2121N12 ⊖ 
 2-pole N/C + N/O break before make, slow break (XE2NP3151)	ZCT25N12 + ZCE10 ⊖ 	ZCT25N12 + ZCE11 ⊖ 	ZCT25N12 + ZCE02 ⊖ 	ZCT25N12 + ZCE21 ⊖ 
 2-pole N/C + N/O make before break, slow break (XE2N P3161)	ZCT26N12 + ZCE10 ⊖ 	ZCT26N12 + ZCE11 ⊖ 	ZCT26N12 + ZCE02 ⊖ 	ZCT26N12 + ZCE21 ⊖ 
 2-pole N/C + N/C simultaneous, slow break (XE2N P3141)	ZCT27N12 + ZCE10 ⊖ 	ZCT27N12 + ZCE11 ⊖ 	ZCT27N12 + ZCE02 ⊖ 	ZCT27N12 + ZCE21 ⊖ 
 2-pole N/O + N/O simultaneous, slow break (XE2NP3131)	ZCT28N12 + ZCE10 ⊖ 	ZCT28N12 + ZCE11 ⊖ 	ZCT28N12 + ZCE02 ⊖ 	ZCT28N12 + ZCE21 ⊖ 
Weight, kg (lb)	0.100 (0.220)	0.100 (0.220)	0.105 (0.231)	0.115 (0.254)
Contact operation	 contact closed  contact open	(A) = cam displacement (P) = positive opening point		⊖ N/C contact with positive opening operation, when properly mounted and using a conforming operator
Characteristics				
Switch actuation	On end	By 30° cam		By any moving part
Type of actuation				
Maximum actuation speed	0.5 m/s (1.64 ft/s)	1 m/s (3.28 ft/s)		1 m/s (3.28 ft/s), any direction
Minimum force or torque	For tripping: 15 N (3.37 lb) For positive opening: 45 N (10.12 lb)	12 N (2.70 lb)	6 N (1.35 lb)	0.3 N·m (2.66 lb-in)
Cable entry (3)	2 entries tapped M16 x 1.5 for ISO cable entry. Clamping capacity 4 to 8 mm (0.16 to 0.31 in.). (1 entry fitted with blanking plug).			

- Form conforming to EN 50047. See page 22.
- Switches with gold contacts or ring connections: please consult your local sales office.
- For cable entries tapped for a PG 11 conduit thread, replace N12 in the catalog number with G11. Example: XCKT2110N12 becomes XCKT2110G11.
- Value taken with actuation by moving part at 100 mm (3.94 in.) from the mountings.

Dimensions

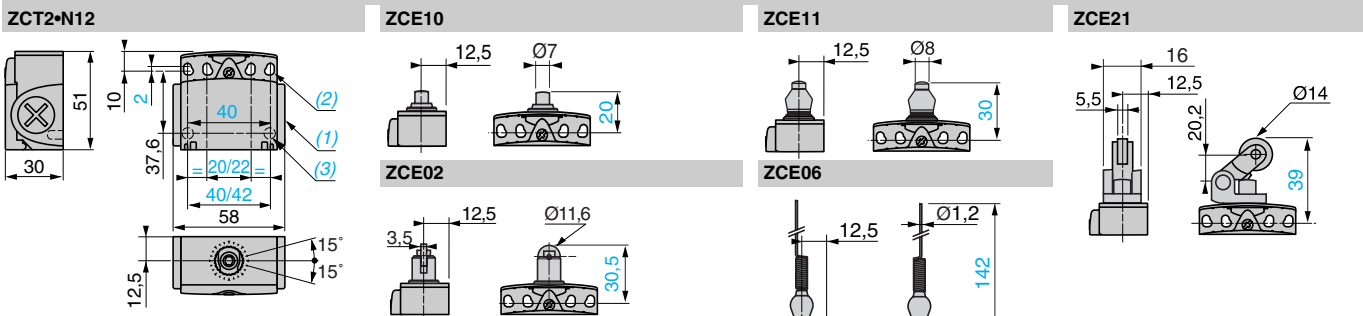

- 2 tapped entries for ISO M16 x 1.5 or PG 11 conduit thread.
- 4 elongated holes Ø 4.3 x 6.3 mm (0.17 x 0.25 in.) on 22/42 mm (0.87/1.65 in.) ctrs., 4 holes Ø 4.3 mm (0.17 in.) on 20/40 mm (0.79/1.57 in.) ctrs.
- 2 x Ø 3 holes for support studs, depth 4 mm (0.16 in.).

Limit Switches

Osiswitch® Compact, Plastic

Universal, XCKT—Complete Units with Two Cable Entries and 1/2" NPT Adapter

Type of head	Plunger (mounting by the head)		Rotary (mounting by the body) Form A (1)		
Type of operator	M18 with metal end plunger	M18 with steel roller plunger	Thermoplastic roller lever	Variable length thermoplastic roller lever	Thermoplastic roller lever, Ø 50 mm (1.97 in.)
Catalog Numbers (2) (3)	XCKT21H0N12 2-pole N/C + N/O snap action (XE2S P3151)	XCKT21H2N12 3,1(A) 7,8(P)	XCKT2118N12 25° 70°(P)	XCKT2145N12 25° 70°(P)	XCKT2139N12 25° 70°(P)
	ZCT25N12 + ZCEH0 1,8 3,2(P)	ZCT25N12 + ZCEH2 3,1(A) 5,6(P)	ZCT25N12 + ZCE01 + ZCY18 25° 46°(P)	ZCT25N12 + ZCE01 + ZCY45 25° 46°(P)	ZCT25N12 + ZCE01 + ZCY39 25° 46°(P)
	ZCT26N12 + ZCEH0 3 4,4(P)	ZCT26N12 + ZCEH2 5,2 7,6(P)	ZCT26N12 + ZCE01 + ZCY18 43° 66°(P)	ZCT26N12 + ZCE01 + ZCY45 43° 66°(P)	ZCT26N12 + ZCE01 + ZCY39 43° 66°(P)
	ZCT27N12 + ZCEH0 1,8 3,2(P)	ZCT27N12 + ZCEH2 3,1 5,6(P)	ZCT27N12 + ZCE01 + ZCY18 25° 46°(P)	ZCT27N12 + ZCE01 + ZCY45 25° 46°(P)	ZCT27N12 + ZCE01 + ZCY39 25° 46°(P)
	ZCT28N12 + ZCEH0 1,8	ZCT28N12 + ZCEH2 3,1(A)	ZCT28N12 + ZCE01 + ZCY18 25°	ZCT28N12 + ZCE01 + ZCY45 25°	ZCT28N12 + ZCE01 + ZCY39 25°
Weight, kg (lb)	0.145 (0.320)	0.145 (0.320)	0.145 (0.320)	0.155 (0.342)	0.160 (0.353)
Contact operation	contact closed (A) = cam displacement contact open (P) = positive opening point		N/C contact with positive opening operation, when properly mounted and using a conforming operator		
Characteristics					
Switch actuation	On end	By 30° cam			
Type of actuation					
Maximum actuation speed	0.5 m/s (1.64 ft/s)		1.5 m/s (4.92 ft/s)		
Minimum force or torque	For tripping	15 N (3.37 lb)	10 N (2.25 lb)	0.1 N•m (0.89 lb-in)	
	For positive opening	45 N (10.12 lb)	36 N (8.09 lb)	0.25 N•m (2.21 lb-in)	
Cable entry (3)	2 entries tapped M16 x 1.5 for ISO cable entry. Clamping capacity 4 to 8 mm (0.16 to 0.31 in.) (1 entry fitted with blanking plug).				

1. Form conforming to EN 50047. See page 22.

2. Switches with gold contacts or ring type connections; please consult your local sales office.

3. For cable entries tapped for a PG 11 conduit thread, replace N12 in the catalog number with **G11**. Example: XCKT21H0N12 becomes **XCKT21H0G11**.

Dimensions

ZCEH0	ZCE01 + ZCY18	ZCE01 + ZCY50	ZCE01 + ZCY45
 12,5, Ø7, 26, M18x1(4)	 40, 5,5, 24, Ø19, 33, 52,5, 12,5	 42, 10, Ø50, 12,5, 58, 77,5	 37,5, 12,5, 5,5, Ø16, 33...83,5, 52...103, 16

4. Mounting nut thickness 3.5 mm (0.14 in.)

Limit Switches

Osiswitch® Compact, Metal and Plastic

Universal, XCKD, XCKP, and XCKT—Modular

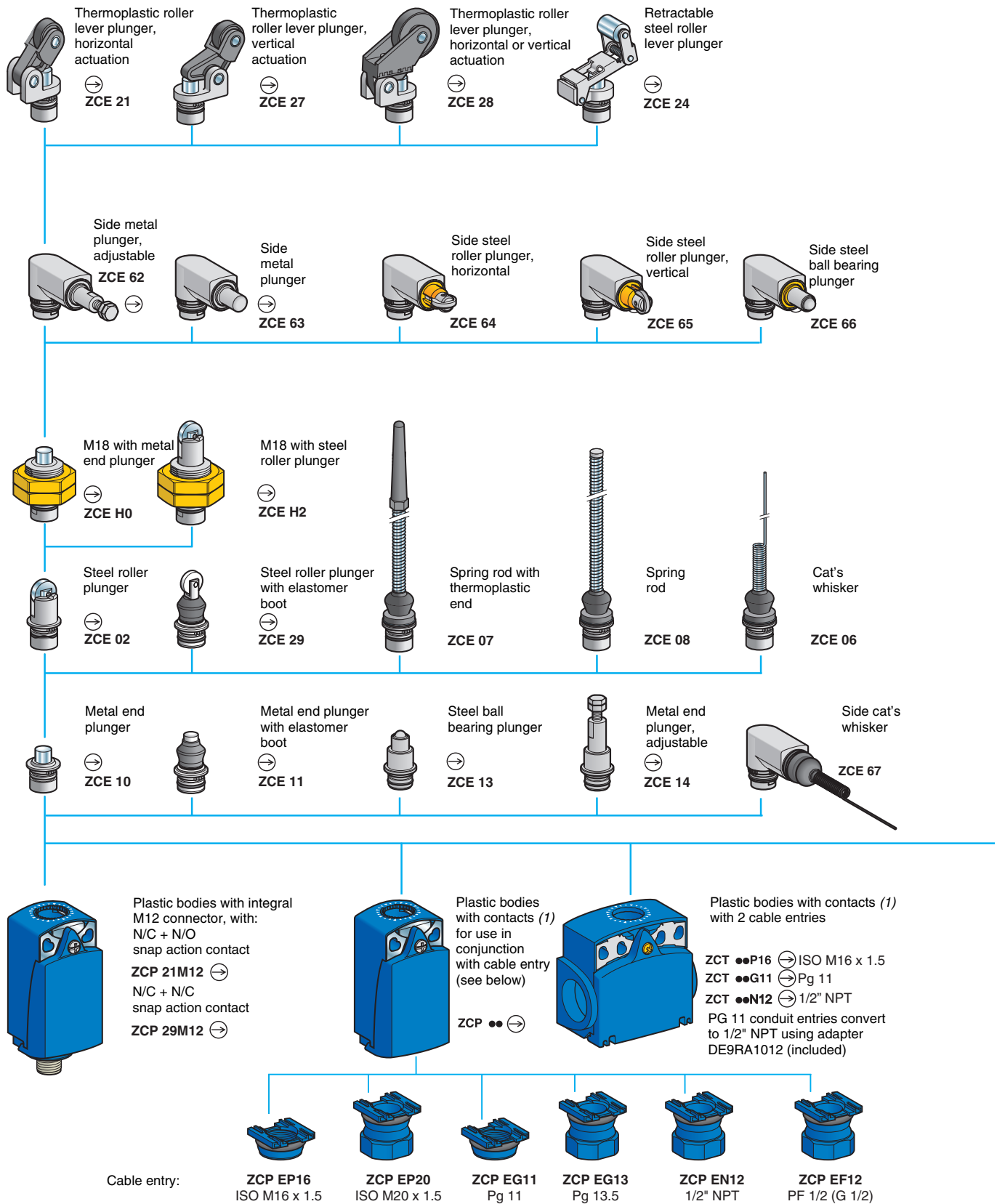

Limit Switches

1. For further details, see page 72.
 2. Cannot be used on bodies: ZCD21, ZCP21, ZCT21, ZCD29, ZCP29, ZCD31, ZCP31, ZCD39, ZCP39, ZCD2•M12, ZCP2•M12.

Limit Switches

Osiswitch® Compact, Metal and Plastic

Universal, XCKD, XCKP, and XCKT—Modular

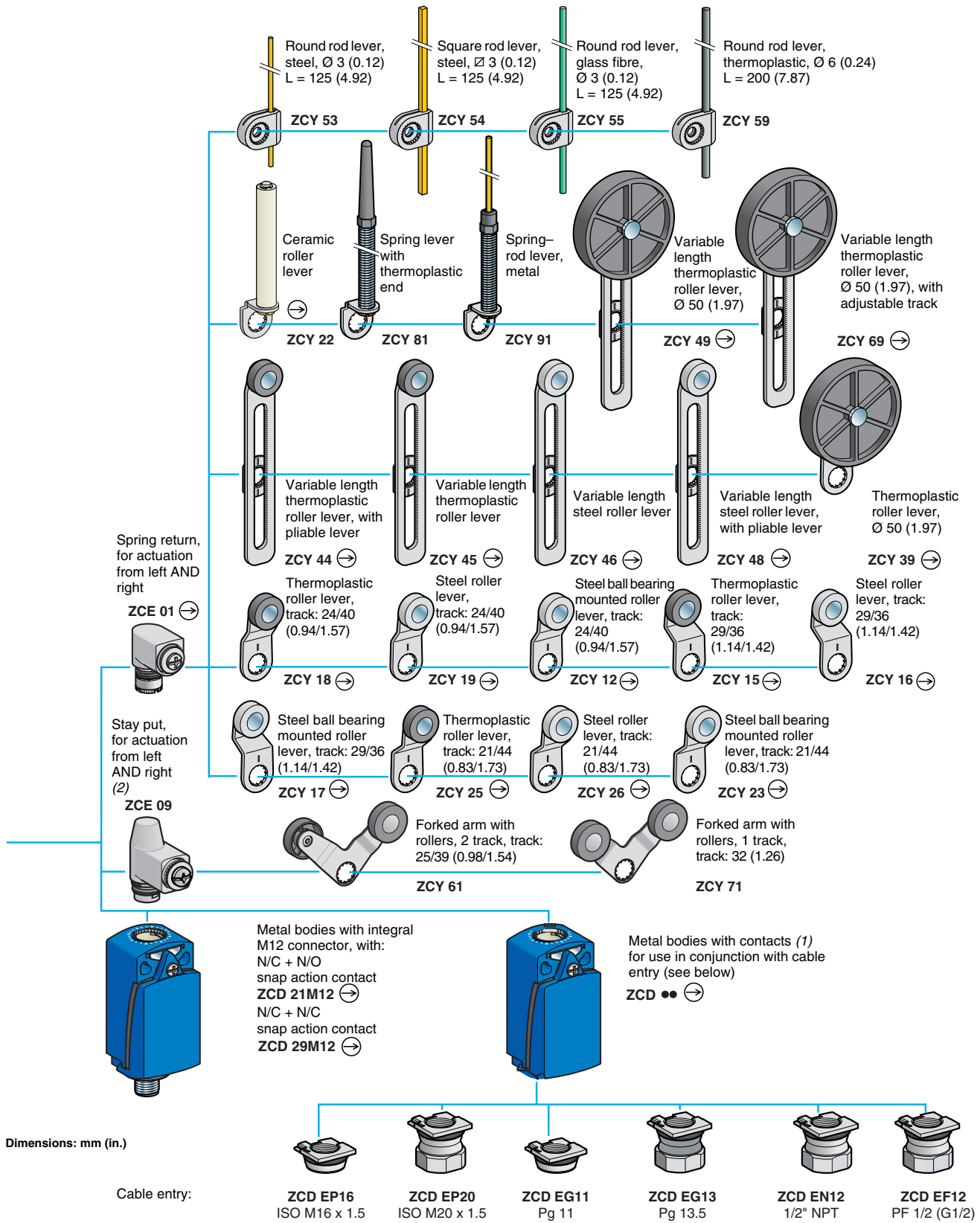

Limit Switches

Osiswitch® Compact, Metal and Plastic

Universal, XCKD, XCKP, and XCKT—Modular

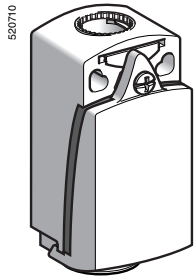

ZCD**

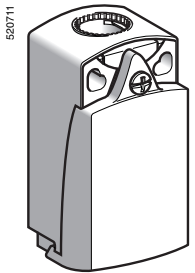

ZCP**

Limit Switches

Bodies with contacts, types XCKD and XCKP ⁽¹⁾					
Type of contact	Positive operation ⁽²⁾	Function diagram	Body material	Catalog Number	Weight kg (lb)
2-pole					
N/C + N/O snap action (XE2SP2151)	⊖		Metal	ZCD21	0.140 (0.309)
			Plastic	ZCP21	0.070 (0.154)
N/C + N/C snap action (XE2SP2141)	⊖		Metal	ZCD29	0.140 (0.309)
			Plastic	ZCP29	0.070 (0.154)
N/C + N/O break before make, slow break (XE2NP2151)	⊖		Metal	ZCD25	0.140 (0.309)
			Plastic	ZCP25	0.070 (0.154)
N/O + N/C make before break, slow break (XE2NP2161)	⊖		Metal	ZCD26	0.140 (0.309)
			Plastic	ZCP26	0.070 (0.154)
N/C + N/C simultaneous, slow break (XE2NP2141)	⊖		Metal	ZCD27	0.140 (0.309)
			Plastic	ZCP27	0.070 (0.154)
N/O + N/O simultaneous, slow break (XE2NP2131)	—		Metal	ZCD28	0.140 (0.309)
			Plastic	ZCP28	0.070 (0.154)
3-pole					
N/C + N/O + N/O snap action (XE3SP2151)	⊖		Metal	ZCD31	0.140 (0.309)
			Plastic	ZCP31	0.070 (0.154)
N/C + N/C + N/O snap action (XE3SP2141)	⊖		Metal	ZCD39	0.140 (0.309)
			Plastic	ZCP39	0.070 (0.154)
N/C + N/C + N/O break before make, slow break (XE3NP2141)	⊖		Metal	ZCD37	0.140 (0.309)
			Plastic	ZCP37	0.070 (0.154)
N/C + N/O + N/O break before make, slow break (XE3NP2151)	⊖		Metal	ZCD35	0.140 (0.309)
			Plastic	ZCP35	0.070 (0.154)

1. Bodies with gold contacts or eyelet type connections: please consult your local sales office.
 2. ⊖ : bodies with contacts assuring positive opening operation, when properly mounted and using a conforming operator.

Limit Switches

Osiswitch® Compact, Metal and Plastic

Universal, XCKD, XCKP, and XCKT—Modular

561390

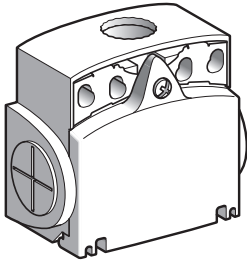

ZCT***

561397

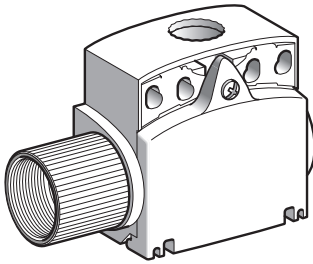

ZCT**N12

Bodies with contacts, type XCKT plastic, 2 cable entries

Type of contact	Positive operation (1)	Function diagram	Cable entries	Catalog Number	Weight kg (lb)
2-pole					
N/C + N/O snap action (XE2SP3151)	☞		ISO M16 x 1.5	ZCT21P16	0.085 (0.187)
			PG 11	ZCT21G11	0.085 (0.187)
N/C + N/O break before make, slow break (XE2NP3151)	☞		ISO M16 x 1.5	ZCT25P16	0.085 (0.187)
			PG 11	ZCT25G11	0.085 (0.187)
N/C + N/C simultaneous, slow break (XE2NP3141)	☞		ISO M16 x 1.5	ZCT27P16	0.085 (0.187)
			PG 11	ZCT27G11	0.085 (0.187)
N/O + N/O simultaneous, slow break (XE2NP3131)	—		ISO M16 x 1.5	ZCT28P16	0.085 (0.187)
			PG 11	ZCT28G11	0.085 (0.187)
N/O + N/C make before break, slow break (XE2NP3161)	☞		ISO M16 x 1.5	ZCT26P16	0.085 (0.187)
			PG 11	ZCT26G11	0.085 (0.187)

Bodies with contacts, type XCKT, plastic, 2 cable entries with 1/2" NPT adapter

Type of contact	Positive operation (1)	Function diagram	Catalog Number	Weight kg (lb)
2-pole				
N/C + N/O snap action (XE2SP3151)	☞		ZCT21N12	0.130 (0.287)
N/C + N/O break before make, slow break (XE2NP3151)	☞		ZCT25N12	0.130 (0.287)
N/C + N/C simultaneous, slow break (XE2N P3141)	☞		ZCT27N12	0.130 (0.287)
N/O + N/O simultaneous, slow break (XE2NP3131)	—		ZCT28N12	0.130 (0.287)
N/O + N/C make before break, slow break (XE2NP3161)	☞		ZCT26N12	0.130 (0.287)

1. ☞ : bodies with contact assuring positive opening operation, when properly mounted and using a conforming operator.

Limit Switches

Osiswitch® Compact, Metal and Plastic Universal, XCKD, XCKP, and XCKT—Modular

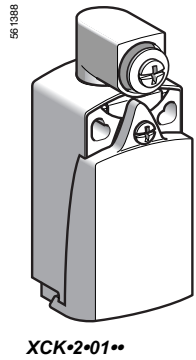
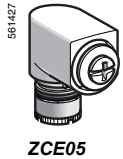

Accessories			
Description	Suitable levers for use with head	Unit catalog number	Weight kg (oz)
Rotary head, without lever, spring return, for actuation from left AND right or left OR right (1)	ZCY12, ZCY15, ZCY16, ZCY17, ZCY18, ZCY19, ZCY22, ZCY23, ZCY25, ZCY26, ZCY39, ZCY53, ZCY54, ZCY55, ZCY81	ZCE05	0.045 (1.59)
Tap-off terminal (for XCKT)	Sold in lots of 10	XALZ09	0.010 (0.35)
Spacer for angular positioning of heads with adjustable levers, for values other than -90°, 0° and 90°	—	XCMZ07	0.002 (0.07)
Adapter for 1/2" NPT conduit Converts PG 11 conduit entries to 1/2" NPT	Sold in lots of 10	DE9RA1012	0.050 (1.76)

Bodies with contacts, type XCKP plastic, with rotary head (without operating lever)					
Type of contact	Function diagram	Positive operation (2)	Cable entry	Catalog Number	Weight kg (lb)
2-pole					
N/C + N/O snap action (XE2SP2151)		⊖	1/2" NPT	XCKP2101N12	0.115 (0.254)
		⊖	PG 11	XCKP2101G11	0.115 (0.254)
		⊖	M12 connector	XCKP2101M12	0.125 (0.276)
N/C + N/O break before make, slow break (XE2NP2151)		⊕	1/2" NPT	XCKP2501N12	0.115 (0.254)
		⊕	PG 11	XCKP2501G11	0.115 (0.254)

Bodies with contacts, type XCKD metal, with rotary head (without operating lever)					
Type of contact	Function diagram	Positive operation (2)	Cable entry	Catalog Number	Weight kg (lb)
2-pole					
N/C + N/O snap action (XE2SP2151)		⊖	1/2" NPT	XCKD2101N12	0.185 (0.408)
		⊖	PG 11	XCKD2101G11	0.185 (0.408)
		⊖	M12 connector	XCKD2101M12	0.195 (0.430)
N/C + N/O break before make, slow break (XE2NP2151)		⊕	1/2" NPT	XCKD2501N12	0.185 (0.408)
		⊕	PG 11	XCKD2501G11	0.185 (0.408)

Limit Switches

Osiswitch® Compact, Metal and Plastic

Universal, XCKD, XCKP, and XCKT—Modular

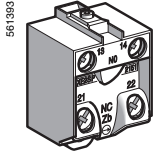

XE2**21**

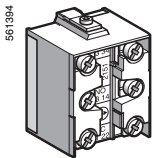

XE3**21**

Contact blocks with screw clamp terminals for XCKD and XCKP

Type of contact	Positive operation (1)	Function diagram	Catalog number for standard contacts	Weight kg (lb)
2-pole				
N/C + N/O snap action	⊕		XE2SP2151	0.020 (0.044)
N/C + N/C simultaneous, snap action	⊕		XE2SP2141	0.020 (0.044)
N/C + N/O break before make, slow break	⊕		XE2NP2151	0.020 (0.044)
N/O + N/C make before break, slow break	⊕		XE2NP2161	0.020 (0.044)
N/C + N/C simultaneous, slow break	⊕		XE2NP2141	0.020 (0.044)
N/O + N/O simultaneous, slow break	—		XE2NP2131	0.020 (0.044)

3-pole

N/C + N/O + N/O snap action	⊕		XE3SP2151	0.035 (0.077)
N/C + N/C + N/O snap action	⊕		XE3SP2141	0.035 (0.077)
N/C + N/C + N/O break before make, slow break	⊕		XE3NP2141	0.035 (0.077)
N/C + N/O + N/O break before make, slow break	⊕		XE3NP2151	0.035 (0.077)

Contact blocks with screw clamp terminals for XCKT





Type of contact	Positive operation (1)	Function diagram	Catalog number for standard contacts	Weight kg (lb)
2-pole				
N/C + N/O snap action	⊕		XE2SP3151	0.015 (0.033)
N/C + N/O break before make, slow break	⊕		XE2NP3151	0.015 (0.033)
N/O + N/C make before break, slow break	⊕		XE2NP3161	0.015 (0.033)
N/C + N/C simultaneous, slow break	⊕		XE2NP3141	0.015 (0.033)
N/O + N/O simultaneous, slow break	—		XE2NP3131	0.015 (0.033)

1. ⊕ : contact blocks assuring positive opening operation, when properly mounted and using a conforming operator.

Limit Switches

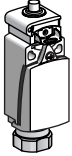
Osiswitch[®] Compact with Manual Reset

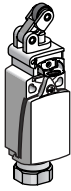
Application, XCDR—Complete Switches, Metal, with One Cable Entry, 1/2" NPT

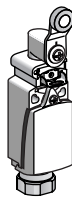

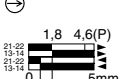
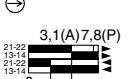
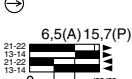
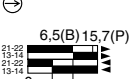
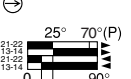
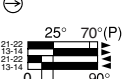
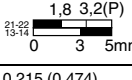
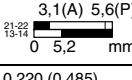
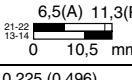
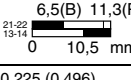
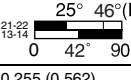
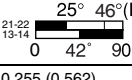
Type of head	Plunger (mounting by the body)				Rotary (mounting by the body)	
						
Type of operator	Metal end plunger	Steel roller plunger	Thermoplastic roller lever plunger, horizontal actuation in 1 direction	Thermoplastic roller lever plunger, vertical actuation in 1 direction	Thermoplastic roller lever	Steel roller lever

Catalog numbers of complete switches with one 1/2" NPT cable entry						
 <p>2-pole N/C + N/O snap action (XE2SP2151)</p>	XCDR2110N12 	XCDR2102N12 	XCDR2121N12 	XCDR2127N12 	XCDR2118N12 	XCDR2119N12 
	XCDR2510N12 	XCDR2502N12 	XCDR2521N12 	XCDR2527N12 	XCDR2518N12 	XCDR2519N12 
Weight, kg (lb)	0.215 (0.474)	0.220 (0.485)	0.225 (0.496)	0.225 (0.496)	0.255 (0.562)	0.255 (0.562)

Catalog numbers of complete switches with one PG 13.5 cable entry
 For complete switches with 1 PG 13.5 cable entry, replace N12 with G13.
 Example: XCDR 2110P20 becomes XCDR 2110G13.

Catalog numbers of complete switches with one P20 cable entry
 For complete switches with 1 ISO M20 x 1.5 cable entry, replace N12 with P20.
 Example: XCDR 2110N12 becomes XCDR 2110P20.

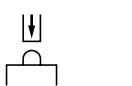
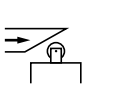
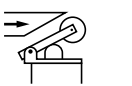
Contact operation	 contact closed  contact open	(A) (B) = cam displacement (P) = positive opening point	 N/C contact with positive opening operation, when properly mounted and using a conforming operator
--------------------------	--	--	--

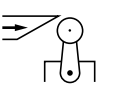
Characteristics					
Switch actuation	On end	By 30° cam			
Type of actuation					
Maximum actuation speed	0.5 m/s (1.64 ft/s)	1 m/s (3.28 ft/s)			1.5 m/s (4.92 ft/s)
Minimum force or torque	For tripping	15 N (3.37 lb)	12 N (2.70 lb)	6 N (1.35 lb)	0.1 N•m (0.89 lb-in)
	For positive opening	45 N (10.12 lb)	36 N (8.09 lb)	18 N (4.05 lb)	0.25 N•m (2.21 lb-in)
Cable entry	1 entry tapped M20 x 1.5 mm for ISO cable entry, clamping capacity 7 to 13 mm (0.28 to 0.51 in.), or 1 entry tapped PG 13.5, clamping capacity 9 to 12 mm (0.35 to 0.47 in.), or 1 entry tapped for 1/2" NPT (USAS B2-1) conduit				

Limit Switches

Limit Switches

Osiswitch® Compact with Manual Reset

Application, XCDR—Complete Switches, Metal, with One Cable Entry, 1/2" NPT

Dimensions

XCDR2•10***

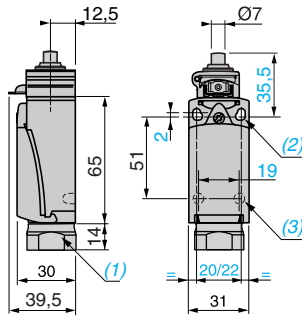

XCDR2•02***

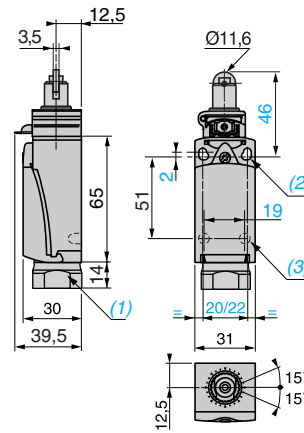

XCDR2•21***

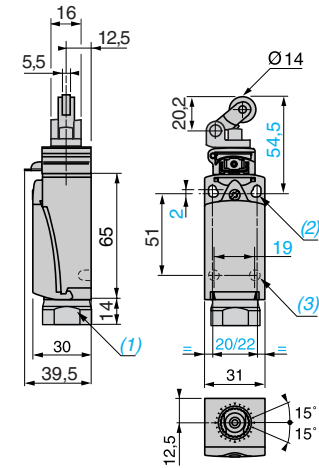

1. Tapped entry for ISO M20 x 1.5 or PG 13.5 conduit thread or 1/2" NPT conduit
2. 2 elongated holes $\varnothing 4.3 \times 6.3$ mm (0.17 x 0.25 in.) on 22 mm (0.87 in.) centers, 2 holes $\varnothing 4.3$ mm (0.17 in.) on 20 mm (0.79 in.) centers
3. 2 x $\varnothing 3$ holes for support studs, depth 4 mm (0.16 in.)

Dimensions

XCDR2•27***

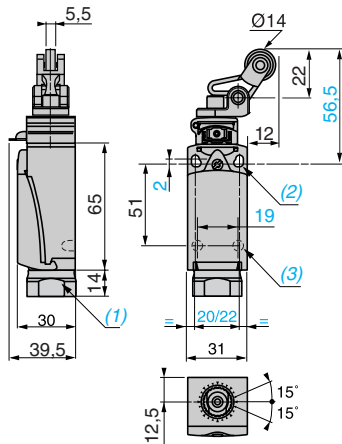

XCDR2•18***, XCDR2•19***

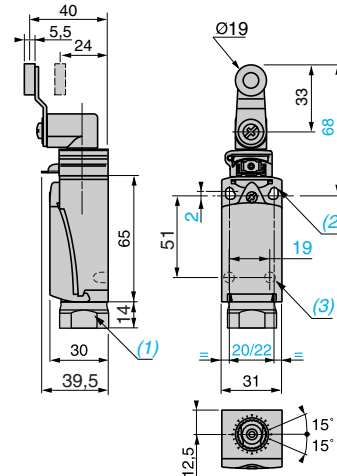

1. Tapped entry for ISO M20 x 1.5 or PG 13.5 conduit thread or 1/2" NPT conduit.
2. 2 elongated holes $\varnothing 4.3 \times 6.3$ mm (0.17 x 0.25 in.) on 22 mm (0.87 in.) centers, 2 holes $\varnothing 4.3$ mm (0.17 in.) on 20 mm (0.79 in.) centers.
3. 2 x $\varnothing 3$ holes for support studs, depth 4 mm (0.16 in.).

Limit Switches

Osiswitch® Compact with Manual Reset

Application, XCPR—Complete Switches, Plastic, with One Cable Entry, 1/2" NPT

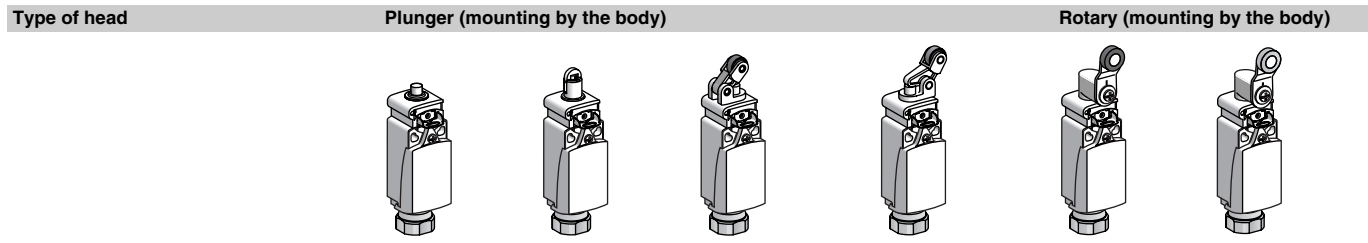

Type of operator	Metal end plunger	Steel roller plunger	Thermoplastic roller lever plunger, horizontal actuation in 1 direction	Thermoplastic roller lever plunger, vertical actuation in 1 direction	Thermoplastic roller lever	Steel roller lever
------------------	-------------------	----------------------	---	---	----------------------------	--------------------

Catalog numbers of complete switches with one 1/2" NPT cable entry

	XCPR2110N12	XCPR2102N12	XCPR2121N12	XCPR2127N12	XCPR2118N12	XCPR2119N12
 2-pole N/C + N/O snap action (XE2SP2151)	 1.8 4,6(P)	 3,1(A) 7,8(P)	 6,5(A) 15,7(P)	 6,5(B) 15,7(P)	 25° 70°(P)	 25° 70°(P)
 2-pole N/C + N/O break before make, slow break (XE2NP2151)	 1.8 3,2(P)	 3,1(A) 5,6(P)	 6,5(A) 11,3(P)	 6,5(B) 11,3(P)	 25° 46°(P)	 25° 46°(P)
 2-pole N/C + N/C snap action (XE2S P2141)	 1.8 4,6(P)	 3,1(A) 7,8(P)	 6,5(A) 15,7(P)	 6,5(B) 15,7(P)	 25° 70°(P)	—
Weight, kg (lb)	0.115 (0.254)	0.115 (0.254)	0.125 (0.276)	0.120 (0.265)	0.155 (0.342)	—

Catalog numbers of complete switches with one PG 13.5 cable entry

For complete switches with one PG 13.5 cable entry, replace N12 with G13.
 Example: XCPR 2110P20 becomes XCPR 2110G13.

Catalog numbers of complete switches with one P20 cable entry

For complete switches with one ISO M20 x 1.5 cable entry, replace N12 with P20.
 Example: XCPR 2110N12 becomes XCPR 2110P20.

Contact operation	contact closed contact open	(A) (B) = cam displacement (P) = positive opening point	N/C contact with positive opening operation, when properly mounted and using a conforming operator
--------------------------	--------------------------------	--	--

Characteristics

Switch actuation	On end	By 30° cam			
Type of actuation					
Maximum actuation speed	0.5 m/s (1.64 ft/s)	1 m/s (3.28 ft/s)			1.5 m/s (4.92 ft/s)
Minimum force or torque	For tripping	15 N (3.37 lb)	12 N (2.70 lb)	6 N (1.35 lb)	0.1 N•m (0.89 lb-in)
	For positive opening	45 N (10.12 lb)	36 N (8.09 lb)	18 N (4.05 lb)	0.25 N•m (2.21 lb-in)
Cable entry	1 entry tapped M20 x 1.5 mm for ISO cable entry, clamping capacity 7 to 13 mm (0.28 to 0.51 in.), or 1 entry tapped PG 13.5, clamping capacity 9 to 12 mm (0.35 to 0.47 in.), or 1 entry tapped for 1/2" NPT (USAS B2-1) conduit				

Other versions Complete switches with cable entries other than those listed above. Consult your local sales office.

Limit Switches

Limit Switches

Osiswitch® Compact with Manual Reset

Application, XCPR—Complete Switches, Plastic, with One Cable Entry, 1/2" NPT

Dimensions

XCPR2•10***

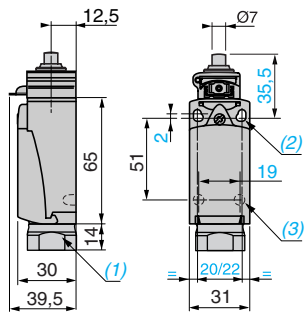

XCPR2•02***

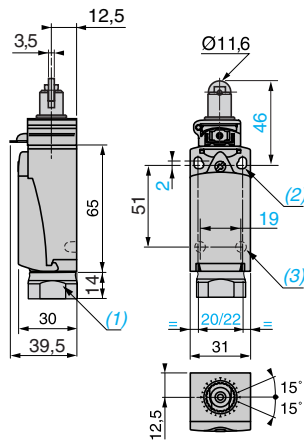

XCPR2•21***

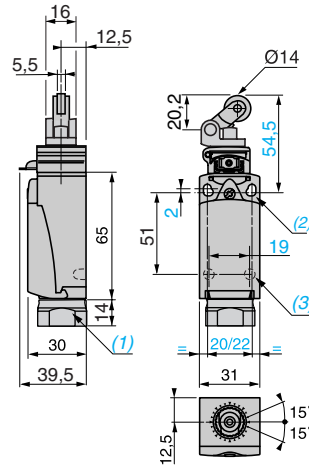

1. Tapped entry for ISO M20 x 1.5 or PG 13.5 conduit thread or 1/2" NPT conduit.
2. 2 elongated holes $\varnothing 4.3 \times 6.3$ mm (0.17 x 0.25 in.) on 22 mm (0.87 in.) centers, 2 holes $\varnothing 4.3$ mm (0.17 in.) on 20 mm (0.79 in.) centers.
3. 2 x $\varnothing 3$ holes for support studs, depth 4 mm (0.16 in.).

Dimensions

XCPR2•27***

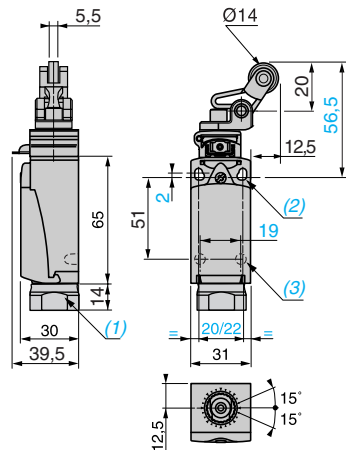

XCPR2•18***, XCPR2•19***

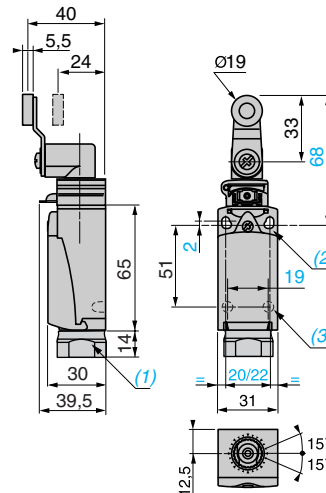









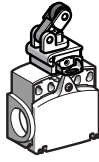

1. Tapped entry for ISO M20 x 1.5 or PG 13.5 conduit thread or 1/2" NPT conduit.
2. 2 elongated holes $\varnothing 4.3 \times 6.3$ mm (0.17 x 0.25 in.) on 22 mm (0.87 in.) centers, 2 holes $\varnothing 4.3$ mm (0.17 in.) on 20 mm (0.79 in.) centers.
3. 2 x $\varnothing 3$ holes for support studs, depth 4 mm (0.16 in.).

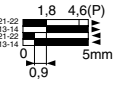
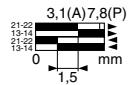
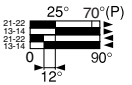
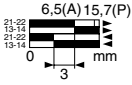
Limit Switches

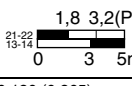
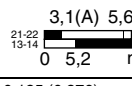
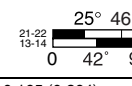
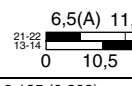
Osiswitch® Compact with Manual Reset

Application, XCTR—Complete Switches, Plastic, with Two Cable Entries, 1/2" NPT

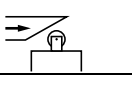
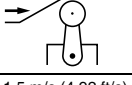
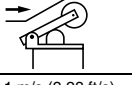
Type of head	Plunger (mounting by the body)			
				
Type of operator	Metal end plunger	Steel roller plunger	Thermoplastic roller lever plunger	Thermoplastic roller lever plunger, horizontal actuation in 1 direction
Catalog numbers of complete switches with two cable entries, 1/2" NPT (1)				
 <p>2-pole N/C + N/O snap action (XE2SP3151)</p>	<p>XCTR2110N12 ⊕</p> 	<p>XCTR2102N12 ⊕</p> 	<p>XCTR2118N12 ⊕</p> 	<p>XCTR2121N12 ⊕</p> 
 <p>2-pole N/C + N/O break before make, slow break (XE2NP3151)</p>	<p>XCTR2510N12 ⊕</p> 	<p>XCTR2502N12 ⊕</p> 	<p>XCTR2518N12 ⊕</p> 	<p>XCTR2521N12 ⊕</p> 
Weight, kg (lb)	0.120 (0.265)	0.125 (0.276)	0.165 (0.364)	0.135 (0.298)
1. One PG 11 to 1/2" NPT adapter and one plug included.				
Catalog numbers of complete switches with two PG 11 cable entries				
For complete switches with two PG 11 cable entries, replace N12 with G11. Example: XCTR 2110N12 becomes XCTR 2110G11 .				
Catalog numbers of complete switches with two ISO M16 x 1.5 cable entries				
For complete switches with two ISO M16 x 1.5 cable entries, replace N12 with P16. Example: XCTR 2110N12 becomes XCTR 2110P16 .				
Weight, kg (lb)	0.120 (0.265)	0.125 (0.276)	0.165 (0.364)	0.135 (0.298)
Contact operation	 contact closed  contact open	(A) = cam displacement (P) = positive opening point	 N/C contact with positive opening operation, when properly mounted and using a conforming operator	
Characteristics				
Switch actuation	On end	By 30° cam		
Type of actuation				
Maximum actuation speed	0.5 m/s (1.64 ft/s)		1.5 m/s (4.92 ft/s)	1 m/s (3.28 ft/s)
Minimum force or torque	For tripping: 15 N (3.37 lb) For positive opening: 45 N (10.12 lb)	12 N (2.70 lb) 36 N (8.09 lb)	0.1 N•m (0.89 lb-in) 0.25 N•m (2.21 lb-in)	6 N (1.35 lb) 18 N (4.05 lb)
Cable entry (1 entry fitted with blanking plug)	2 entries tapped M16 x 1.5 mm for ISO cable entry, clamping capacity 4 to 8 mm (0.16 to 0.31 in.), or 2 entries tapped PG 11, clamping capacity 7 to 10 mm (0.28 to 0.39 in.), or 2 entries tapped for 1/2" NPT (USAS B2-1) conduit using PG 11 to 1/2" NPT adapter DE9RA1012 (1 entry fitted with adapter)			

Limit Switches

Osiswitch® Compact, Metal with Manual Reset

Application, XCDR—Complete Switches with Two Cable Entries, 1/2" NPT

Dimensions

XCTR 2•18***

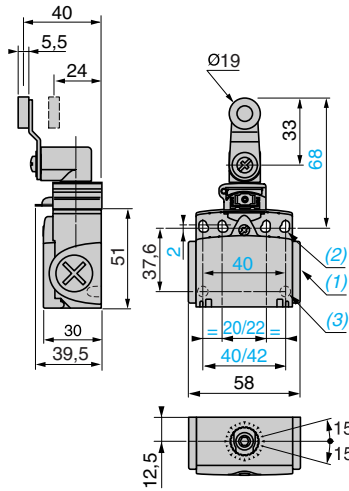

XCTR 2•21***

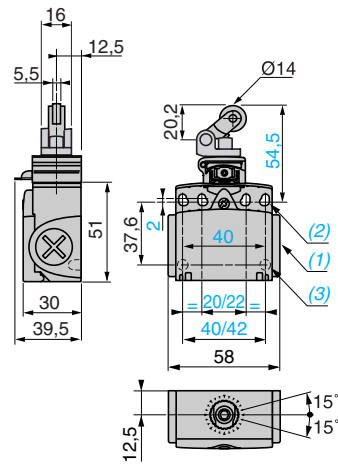

1. Tapped entry for ISO M16 x 1.5 or PG 11 conduit thread. 1/2" NPT adapter included.
2. 4 elongated holes \varnothing 4.3 x 6.3 mm (0.17 x 0.25 in.) on 22/42 mm (0.87/1.65 in.) centers, 4 holes \varnothing 4.3 mm (0.17 in.) on 20/40 mm (0.79/1.57 in.) centers.
3. 2 x \varnothing 3 holes for support studs, depth 4 mm (0.16 in.).

XCTR 2•10***

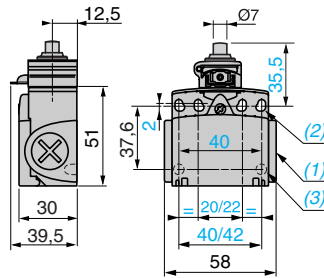

XCTR 2•02***

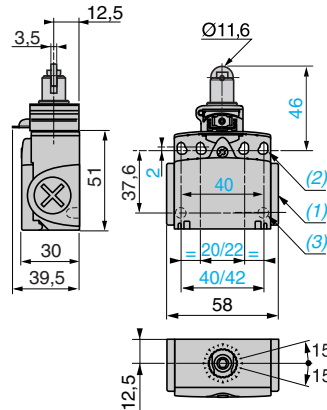

DE9RA1012

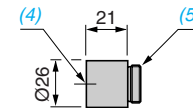

1. Tapped entry for ISO M16 x 1.5 or PG 11 conduit thread. 1/2" NPT adapter included.
2. 4 elongated holes \varnothing 4.3 x 6.3 mm (0.17 x 0.25 in.) on 22/42 mm (0.87/1.65 in.) centers, 4 holes \varnothing 4.3 mm (0.17 in.) on 20/40 mm (0.79/1.57 in.) centers.
3. 2 x \varnothing 3 holes for support studs, depth 4 mm (0.16 in.).
4. Tapped entry for 1/2" NPT conduit.
5. PG 11 threaded sleeve.

Limit Switches

Osiswitch® Classic, Metal

XCKM, XCKL, and XCKML

■ **XCKM**
with 3 cable entries

□ With plunger head

561643

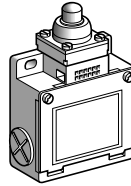

561644

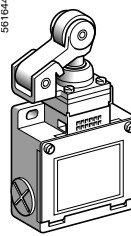

□ With rotary or multi-directional head

808148

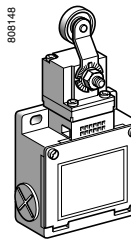

561645

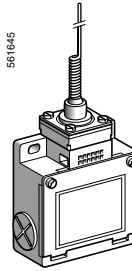

Page 84

■ **XCKL**
with 1 cable entry

□ With plunger head

808140

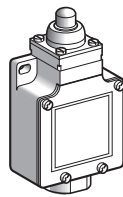

808145

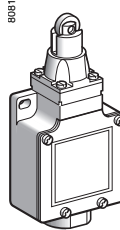

□ With rotary or multi-directional head

808141

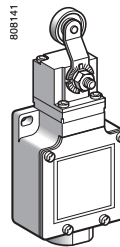

808147

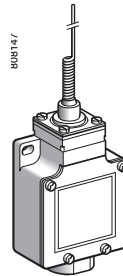

Page 86

■ **XCKML**
with 3 cable entries and two 2-pole contacts

□ With plunger head

561639

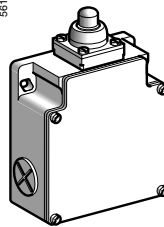

561640

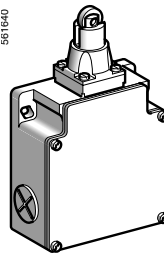

□ With rotary or multi-directional head

561641

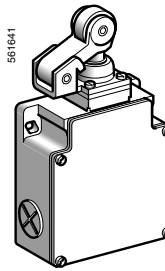

561642

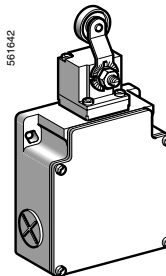

Page 96

Environmental characteristics

Conforming to standards	Products	IEC 60947-5-1, EN 60947-5-1, UL 508, CSA C22-2 n° 14
	Machine assemblies	IEC 60204-1, EN 60204-1
Product certifications		UL, CSA, CCC (for XCKM)
Protective treatment	Version	Standard "TC". Special "TH"
Ambient air temperature	For operation	- 25...+70 °C (-13...+158 °F)
	For storage	- 40...+70 °C (-40...+158 °F)
Vibration resistance	Conforming to IEC 60068-2-6	25 gn (10...500 Hz)
Shock resistance	Conforming to IEC 60068-2-27	50 gn (11 ms)
Electric shock protection		Class I conforming to IEC 61140 and NF C 20-030
Degree of protection		IP 66 conforming to IEC 60529; IK 05 conforming to EN 50102
Repeat accuracy		XCKML 0.1 mm; XCKM and XCKL 0.05 mm on the tripping points, with 1 million operating cycles for head with end plunger
Cable entry or integral connector	Depending on model	XCKM: 3 tapped entries, PG 11 conduit thread (1/2" NPT adapter available), or tapped M20 XCKL: 1 tapped entry incorporating 1/2" NPT adapter XCKML: 3 tapped entries, PG 13 conduit thread (1/2" NPT adapter included), or tapped M20
Materials		Bodies: Zamak® zinc alloy Rotary heads: Zamak® zinc alloy or plastic depending on model; other heads: plastic

Limit Switches

Osiswitch® Classic, Metal

XCKM, XCKL, and XCKML

Contact block characteristics																																																																							
Rated operational characteristics	XE2•P	~ AC-15; A300 (Ue = 240 V, Ie = 3 A); Ithe = 10 A --- DC-13; Q300 (Ue = 250 V, Ie = 0,27 A), conforming to IEC 60947-5-1 Appendix A, EN 60947-5-1																																																																					
	XE3•P	~ AC-15; B300 (Ue = 240 V, Ie = 1,5 A); Ithe = 6 A --- DC-13; R300 (Ue = 250 V, Ie = 0,1 A), conforming to IEC 60947-5-1 Appendix A, EN 60947-5-1																																																																					
Rated insulation voltage	XE2•P	Ui = 500 V degree of pollution 3 conforming to IEC 60947-1 Ui = 300 V conforming to UL 508, CSA C22-2 n° 14																																																																					
	XE3•P	Ui = 400 V degree of pollution 3 conforming to IEC 60947-1 Ui = 300 V conforming to UL 508, CSA C22-2 n° 14																																																																					
Rated impulse withstand voltage	XE2•P	U imp = 6 kV conforming to IEC 60947-1, IEC 60664																																																																					
	XE3•P	U imp = 4 kV conforming to IEC 60947-1, IEC 60664																																																																					
Positive operation (depending on model)	N/C contacts with positive opening operation conforming to IEC 947-5-1 Section 3, EN 60 947-5-1																																																																						
Resistance across terminals	≤ 25 mΩ conforming to IEC 60255-7 category 3																																																																						
Short-circuit protection	XE2•P	10 A cartridge fuse type gG (gl)																																																																					
	XE3•P	6 A cartridge fuse type gG (gl)																																																																					
Cabling (screw and captive cable clamp terminals)	XE2SP21•1	Clamping capacity, min: 1 x 0,34 mm ² , max: 2 x 1,5 mm ²																																																																					
	XE2NP21•1	Clamping capacity, min: 1 x 0,5 mm ² , max: 2 x 2,5 mm ²																																																																					
	XESP2151L and XENP2151L	Clamping capacity, min: 1 x 0,34 mm ² , max: 2 x 1,5 mm ² or 1 x 2,5 mm ²																																																																					
	XE3NP et XE3SP	Clamping capacity, min: 1 x 0,34 mm ² , max: 1 x 1 mm ² or 2 x 0,75 mm ²																																																																					
Minimum actuation speed	XE2SP21•1, XESP2151L and XE3SP: 0.01 m/minute (0.03 ft/minute)																																																																						
	XE2NP21•1, XENP2151L and XE3NP: 6 m/minute (19.68 ft/minute)																																																																						
Electrical durability	<ul style="list-style-type: none"> Conforming to IEC 60947-5-1 appendix C Utilization categories AC-15 and DC-13 Maximum operating rate: 3600 operating cycles/hour Load factor: 0,5 																																																																						
		<table border="1"> <thead> <tr> <th colspan="2">XE2SP21•1, XE2SP2141, XESP2151L</th> <th colspan="2">XE2NP21•1, XENP2151L</th> </tr> </thead> <tbody> <tr> <td rowspan="2">a.c. supply ~ 50/60 Hz ~ inductive circuit</td> <td></td> <td></td> </tr> <tr> <td><table border="1"> <thead> <tr> <th colspan="4">Power switched in W for 5 million operating cycles</th> </tr> <tr> <th>Voltage</th> <th>V</th> <th>24</th> <th>48</th> <th>120</th> </tr> </thead> <tbody> <tr> <td>~</td> <td>W</td> <td>10</td> <td>7</td> <td>4</td> </tr> </tbody> </table></td> <td><table border="1"> <thead> <tr> <th colspan="4">Power switched in W for 5 million operating cycles</th> </tr> <tr> <th>Voltage</th> <th>V</th> <th>24</th> <th>48</th> <th>120</th> </tr> </thead> <tbody> <tr> <td>~</td> <td>W</td> <td>13</td> <td>9</td> <td>7</td> </tr> </tbody> </table></td> </tr> <tr> <td rowspan="2">d.c. supply ---</td> <td></td> <td></td> </tr> <tr> <td><table border="1"> <thead> <tr> <th colspan="4">Power switched in W for 5 million operating cycles</th> </tr> <tr> <th>Voltage</th> <th>V</th> <th>24</th> <th>48</th> <th>120</th> </tr> </thead> <tbody> <tr> <td>---</td> <td>W</td> <td>3</td> <td>2</td> <td>1</td> </tr> </tbody> </table></td> <td><table border="1"> <thead> <tr> <th colspan="4">Power switched in W for 5 million operating cycles</th> </tr> <tr> <th>Voltage</th> <th>V</th> <th>24</th> <th>48</th> <th>120</th> </tr> </thead> <tbody> <tr> <td>---</td> <td>W</td> <td>4</td> <td>3</td> <td>2</td> </tr> </tbody> </table></td> </tr> </tbody> </table>	XE2SP21•1, XE2SP2141, XESP2151L		XE2NP21•1, XENP2151L		a.c. supply ~ 50/60 Hz ~ inductive circuit			<table border="1"> <thead> <tr> <th colspan="4">Power switched in W for 5 million operating cycles</th> </tr> <tr> <th>Voltage</th> <th>V</th> <th>24</th> <th>48</th> <th>120</th> </tr> </thead> <tbody> <tr> <td>~</td> <td>W</td> <td>10</td> <td>7</td> <td>4</td> </tr> </tbody> </table>	Power switched in W for 5 million operating cycles				Voltage	V	24	48	120	~	W	10	7	4	<table border="1"> <thead> <tr> <th colspan="4">Power switched in W for 5 million operating cycles</th> </tr> <tr> <th>Voltage</th> <th>V</th> <th>24</th> <th>48</th> <th>120</th> </tr> </thead> <tbody> <tr> <td>~</td> <td>W</td> <td>13</td> <td>9</td> <td>7</td> </tr> </tbody> </table>	Power switched in W for 5 million operating cycles				Voltage	V	24	48	120	~	W	13	9	7	d.c. supply ---			<table border="1"> <thead> <tr> <th colspan="4">Power switched in W for 5 million operating cycles</th> </tr> <tr> <th>Voltage</th> <th>V</th> <th>24</th> <th>48</th> <th>120</th> </tr> </thead> <tbody> <tr> <td>---</td> <td>W</td> <td>3</td> <td>2</td> <td>1</td> </tr> </tbody> </table>	Power switched in W for 5 million operating cycles				Voltage	V	24	48	120	---	W	3	2	1	<table border="1"> <thead> <tr> <th colspan="4">Power switched in W for 5 million operating cycles</th> </tr> <tr> <th>Voltage</th> <th>V</th> <th>24</th> <th>48</th> <th>120</th> </tr> </thead> <tbody> <tr> <td>---</td> <td>W</td> <td>4</td> <td>3</td> <td>2</td> </tr> </tbody> </table>	Power switched in W for 5 million operating cycles				Voltage	V	24	48	120	---	W	4	3
XE2SP21•1, XE2SP2141, XESP2151L		XE2NP21•1, XENP2151L																																																																					
a.c. supply ~ 50/60 Hz ~ inductive circuit																																																																							
	<table border="1"> <thead> <tr> <th colspan="4">Power switched in W for 5 million operating cycles</th> </tr> <tr> <th>Voltage</th> <th>V</th> <th>24</th> <th>48</th> <th>120</th> </tr> </thead> <tbody> <tr> <td>~</td> <td>W</td> <td>10</td> <td>7</td> <td>4</td> </tr> </tbody> </table>	Power switched in W for 5 million operating cycles				Voltage	V	24	48	120	~	W	10	7	4	<table border="1"> <thead> <tr> <th colspan="4">Power switched in W for 5 million operating cycles</th> </tr> <tr> <th>Voltage</th> <th>V</th> <th>24</th> <th>48</th> <th>120</th> </tr> </thead> <tbody> <tr> <td>~</td> <td>W</td> <td>13</td> <td>9</td> <td>7</td> </tr> </tbody> </table>	Power switched in W for 5 million operating cycles				Voltage	V	24	48	120	~	W	13	9	7																																									
Power switched in W for 5 million operating cycles																																																																							
Voltage	V	24	48	120																																																																			
~	W	10	7	4																																																																			
Power switched in W for 5 million operating cycles																																																																							
Voltage	V	24	48	120																																																																			
~	W	13	9	7																																																																			
d.c. supply ---																																																																							
	<table border="1"> <thead> <tr> <th colspan="4">Power switched in W for 5 million operating cycles</th> </tr> <tr> <th>Voltage</th> <th>V</th> <th>24</th> <th>48</th> <th>120</th> </tr> </thead> <tbody> <tr> <td>---</td> <td>W</td> <td>3</td> <td>2</td> <td>1</td> </tr> </tbody> </table>	Power switched in W for 5 million operating cycles				Voltage	V	24	48	120	---	W	3	2	1	<table border="1"> <thead> <tr> <th colspan="4">Power switched in W for 5 million operating cycles</th> </tr> <tr> <th>Voltage</th> <th>V</th> <th>24</th> <th>48</th> <th>120</th> </tr> </thead> <tbody> <tr> <td>---</td> <td>W</td> <td>4</td> <td>3</td> <td>2</td> </tr> </tbody> </table>	Power switched in W for 5 million operating cycles				Voltage	V	24	48	120	---	W	4	3	2																																									
Power switched in W for 5 million operating cycles																																																																							
Voltage	V	24	48	120																																																																			
---	W	3	2	1																																																																			
Power switched in W for 5 million operating cycles																																																																							
Voltage	V	24	48	120																																																																			
---	W	4	3	2																																																																			

Limit Switches

Osiswitch® Classic, Metal

XCKM—Complete Switches w/ 3 ISO M20x1.5 Cable Entries, Including One 1/2" NPT Adapter

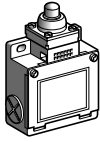
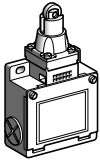
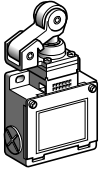
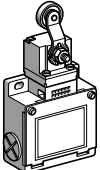
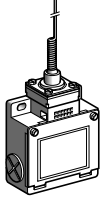
Type of head	Plunger (mounting by the body)			Rotary (mounting by the body)	Multi-directional (mounting by the body)
					
Type of operator	Metal end plunger	Steel roller plunger	Thermoplastic roller lever plunger, horizontal actuation in 1 direction	Thermoplastic roller lever (1)	Cat's whisker (4)
Catalog numbers (2) (3)					
2-pole N/C + N/O snap action (XE2SP2151)					
2-pole N/C + N/O break before make, slow break (XE2NP2151)					
2-pole N/C + N/C snap action (XE2SP2141)					
2-pole N/C + N/C simultaneous, slow break (XE2NP2141)					
3-pole N/C + N/C + N/O snap action (XE3SP2141)					
3-pole N/C + N/C + N/O break before make, slow break (XE3NP2141)					
Weight, kg (lb)	0.250 (0.551)	0.255 (0.562)	0.300 (0.661)	0.280 (0.617)	0.250 (0.551)
Contact operation		(A) = cam displacement (P) = positive opening point			
Characteristics					
Switch actuation	On end	By 30° cam			By any moving part
Type of actuation					
Maximum actuation speed	0.5 m/s (1.64 ft/s)		1.5 m/s (4.92 ft/s)		1 m/s (3.28 ft/s), any direction
Minimum force or torque	For tripping	15 N (3.37 lb)	12 N (2.70 lb)	8 N (1.80 lb)	0.1 N•m (0.89 lb-in)
	For positive opening	45 N (10.12 lb)	36 N (8.09 lb)	24 N (5.40 lb)	0.25 N•m (2.21 lb-in)
Cable entry (3)	3 entries tapped M20 x 1.5 mm for ISO cable entry, clamping capacity 7 to 13 mm (0.28 to 0.51 in.)				

- Adjustable throughout 360° in 5° steps, or in 90° steps by reversing the notched washer.
 - Switches with gold contacts or eyelet type connections: please consult your local sales office.
 - For an entry tapped for a PG 11 conduit thread, delete H29 from the end of the catalog number. Example: XCKM110H29 becomes XCKM110.
 - Value taken with actuation by moving part at 100 mm (3.94 in.) from the mounting.
- Note:** To convert XCKM110 from PG 11 to 1/2" NPT, use adapter DE9RA1012, included.

Limit Switches

Osiswitch® Classic, Metal

XCKM—Complete Switches w/ 3 ISO M20x1.5 Cable Entries, Including One 1/2" NPT Adapter

XCKM•10
ZCKMD3• + ZCKD10

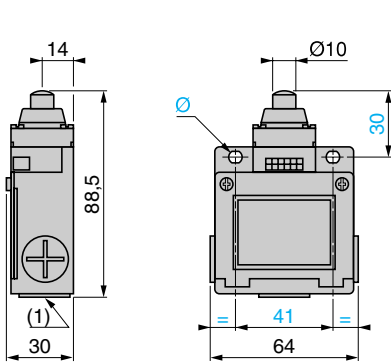

XCKM•02
ZCKMD3• + ZCKD02

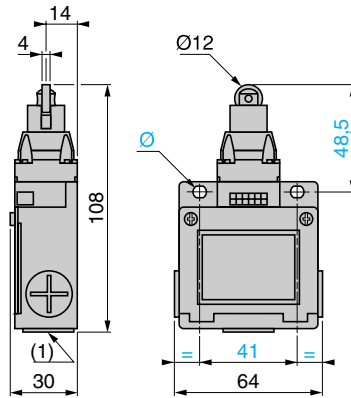

XCKM•21
ZCKMD3• + ZCKD21

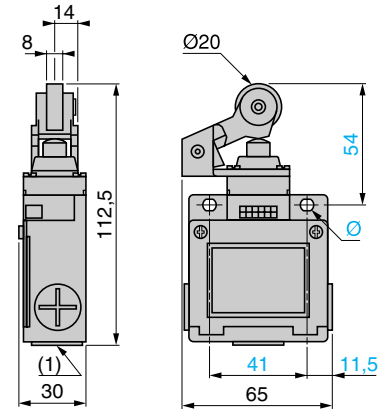

XCKM•15
ZCKMD3• + ZCKD15

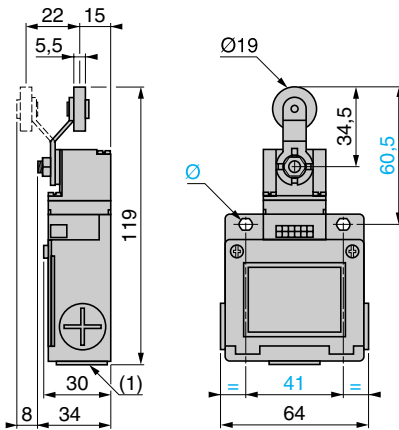

XCKM•06
ZCKMD3• + ZCKD06

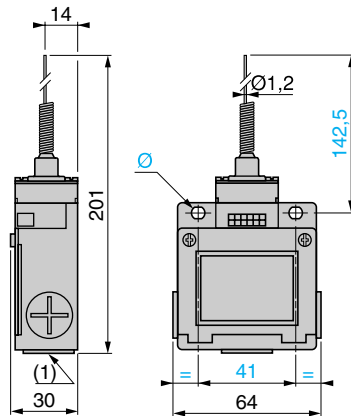

Rear view
XCKM•••, ZCKM•, ZCKMD3•

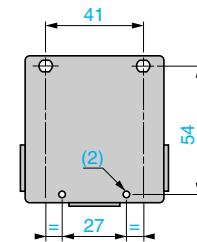

1. 3 tapped entries for ISO M20 x 1.5 or PG 11 conduit thread. Includes 1/2" NPT conduit adapter DE9RA1012.
2. 2 x Ø 4 H 11, depth 10.
- Ø: 2 elongated holes Ø 5.2 x 6.2.

Adapter for 1/2" NPT conduit
DE9RA1012

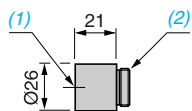









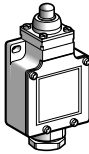
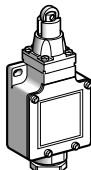
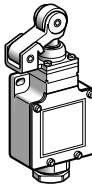
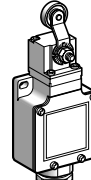
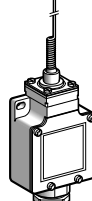

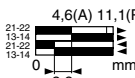



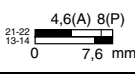



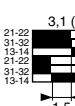
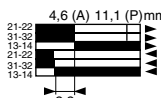

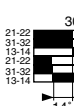

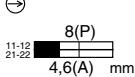

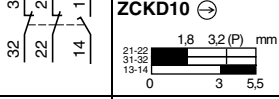
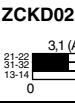
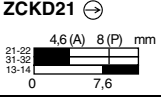
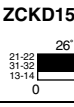
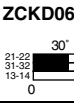
1. Tapped entry for 1/2" NPT conduit.
2. PG 11 threaded sleeve.

Limit Switches

Osiswitch® Classic, Metal

XCKL—Complete Switches Incorporating Adapter for 1/2" NPT

Type of head	Plunger (mounting by the body)			Rotary (mounting by the body)	Multi-directional (mounting by the body)
					
Type of operator	Metal end plunger	Steel roller plunger	Thermoplastic roller lever plunger, horizontal actuation in 1 direction	Thermoplastic roller lever (1)	Cat's whisker (2)
Catalog numbers (3)					
2-pole N/C + N/O snap action (XE2SP2151)	 XCKL110 ⊖ 1.8 4.5(P) 0.9 5.5mm	 XCKL102 ⊖ 3.1(A) 7.8(P) 1.5 mm	 XCKL121 ⊖ 4.6(A) 11.1(P) 2.2 mm	 XCKL115 ⊖ 26° 58°(P) 11° 70°	 XCKL106 ⊖ 30° 14°
2-pole N/C + N/O break before make, slow break (XE2NP2151)	 XCKL510 ⊖ 1.8 3.2(P) 0 3 5.5mm	 XCKL502 ⊖ 3.1(A) 5.6(P) 0 5.2 mm	 XCKL521 ⊖ 4.6(A) 8(P) 0 7.6 mm	 XCKL515 ⊖ 26° 42°(P) 36° 70°	 XCKL506 ⊖ 30° 0 40°
3-pole N/C + N/C + N/O snap action (XE3SP2141)	 ZCKLD39 + ZCKD10 ⊖ 1.8 4.5 (P) mm 0.9 5.5	 ZCKLD39 + ZCKD02 ⊖ 3.1 (A) 7.8 (P) mm 1.5	 ZCKLD39 + ZCKD21 ⊖ 4.6 (A) 11.1 (P) mm 2.2	 ZCKLD39 + ZCKD15 ⊖ 26° 58° (P) 11° 70°	 ZCKLD39 + ZCKD06 ⊖ 30° 14°
2-pole N/C + N/C simultaneous, slow break (XE2NP2141)	 ZCKL7 + ZCKD10 ⊖ 3.2(P) 1.8 5.5mm	 ZCKL7 + ZCKD02 ⊖ 5.6(P) 3.1(A) 9mm	 ZCKL7 + ZCKD21 ⊖ 8(P) 4.6(A) mm	 ZCKL7 + ZCKD15 ⊖ 42°(P) 23° 70°	 ZCKL7 + ZCKD06 ⊖ 30°
3-pole N/C + N/C + N/O break before make, slow break (XE3NP2141)	 ZCKLD37 + ZCKD10 ⊖ 1.8 3.2 (P) mm 0 3 5.5	 ZCKLD37 + ZCKD02 ⊖ 3.1 (A) 3.2 (P) mm 0 5.2 5.5	 ZCKLD37 + ZCKD21 ⊖ 4.6 (A) 8 (P) mm 0 7.6	 ZCKLD37 + ZCKD15 ⊖ 26° 42° (P) 36° 70°	 ZCKLD37 + ZCKD06 ⊖ 30° 0 40°
Weight, kg (lb)	0.255 (0.562)	0.260 (0.573)	0.305 (0.672)	0.285 (0.628)	0.255 (0.562)
Contact operation	 contact closed  contact open	(A) = cam displacement (P) = positive opening point		⊖ N/C contact with positive opening operation, when properly mounted and using a conforming operator	
Characteristics					
Switch actuation	On end	By 30° cam			By any moving part
Type of actuation					
Maximum actuation speed	0.5 m/s (1.64 ft/s)		1.5 m/s (4.92 ft/s)		1 m/s (3.28 ft/s), any direction
Minimum force or torque	For tripping	15 N (3.37 lb)	12 N (2.70 lb)	8 N (1.80 lb)	0.1 N•m (0.89 lb-in)
	For positive opening	45 N (10.12 lb)	36 N (8.09 lb)	24 N (5.40 lb)	0.25 N•m (2.21 lb-in)
Cable entry	1 entry incorporating metal cable entry. Clamping capacity 6 to 13.5 mm (0.24 to 0.53 in.).				

1. Adjustable throughout 360° in 5° steps, or in 90° steps by reversing the notched washer.
 2. Value taken with actuation by moving part at 100 mm (3.94 in.) from the mounting.
 3. Switches with gold contacts or eyelet type connections: please consult your local sales office.

Limit Switches

Osiswitch® Classic, Metal

XCKL—Complete Switches Incorporating Adapter for 1/2" NPT

XCKL•10
ZCKL• + ZCKD10
ZCKLD3• + ZCKD10

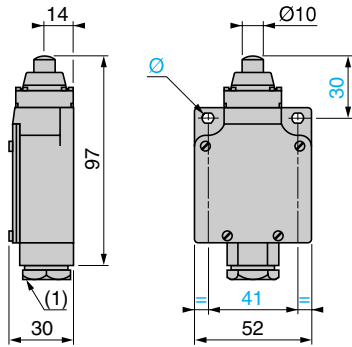

XCKL•02
ZCKL3• + ZCKD02
ZCKLD3• + ZCKD02

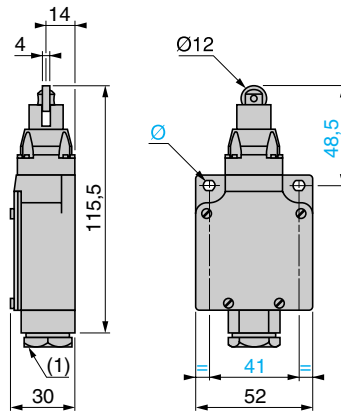

XCKL•21
ZCKL• + ZCKD21
ZCKLD3• + ZCKD21

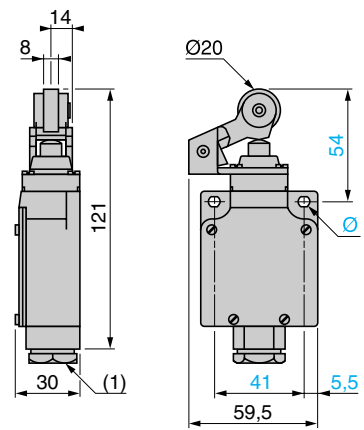

XCKL•15
ZCKL• + ZCKD15
ZCKLD3• + ZCKD15

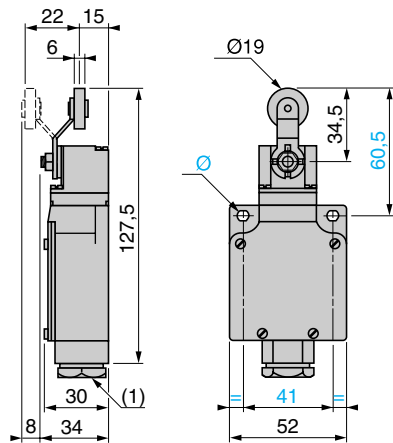

XCKL•06
ZCKL• + ZCKD06
ZCKLD3• + ZCKD06

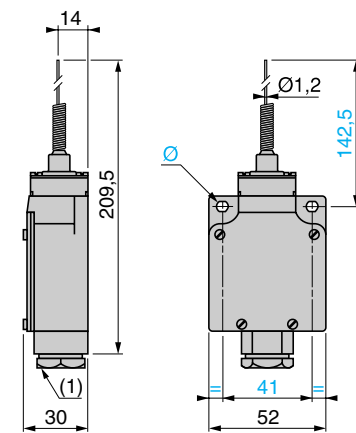

Body mountings

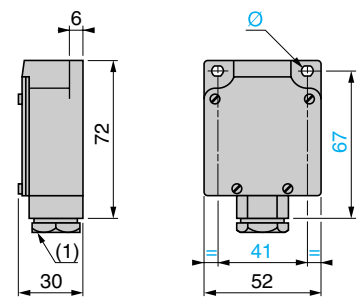

1. Incorporated cable entry.
Ø: 2 elongated holes Ø 5.2 x 6.2.

Limit Switches

Osiswitch® Classic, Metal

XCKM and XCKL—Modular

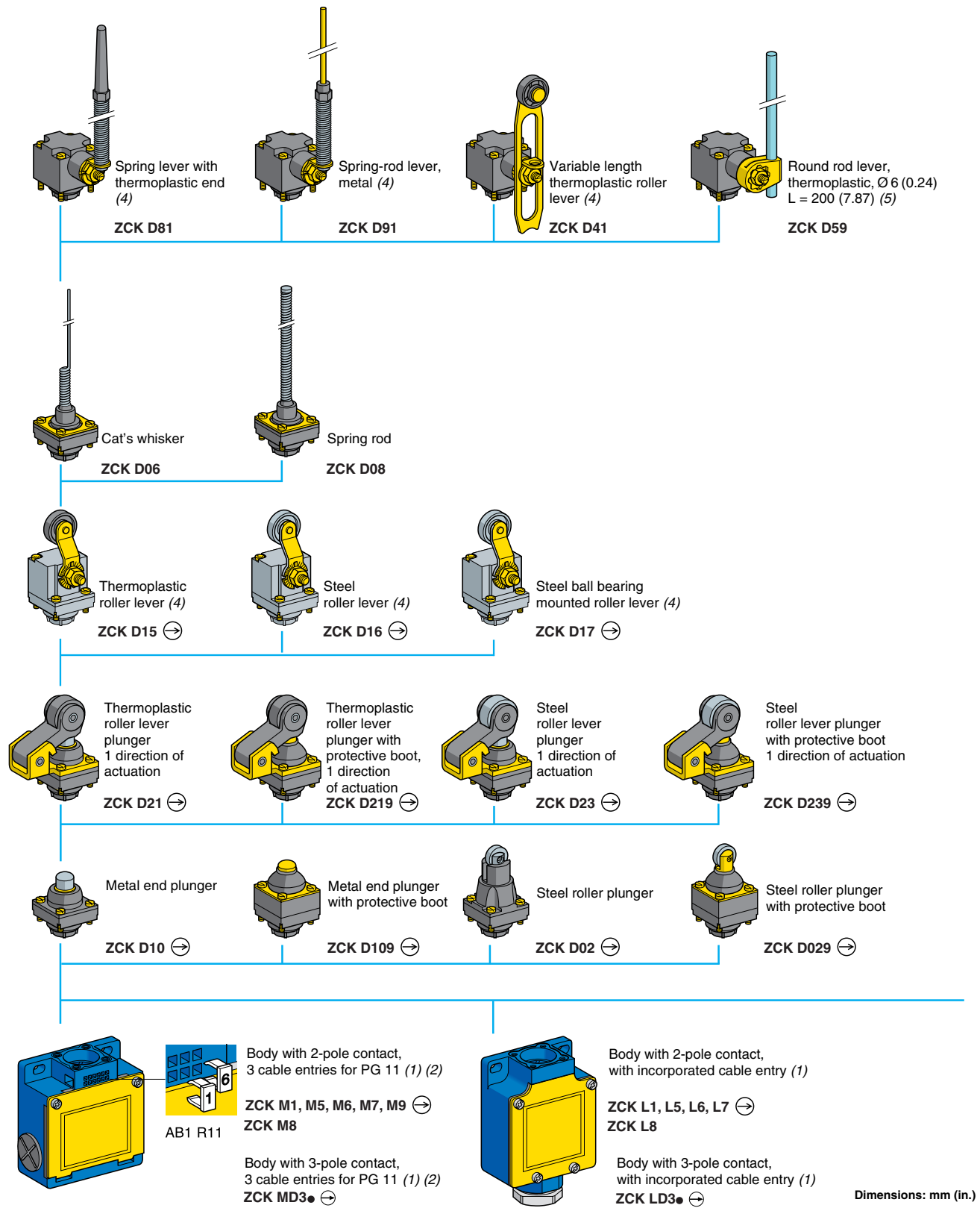

1. For further details. See page 90.
2. For 3 cable entries tapped ISO M20 x 1.5, add **H29** to the catalog number. Example: ZCKM1 becomes **ZCKM1H29**.

Limit Switches

Osiswitch® Classic, Metal

XCKM and XCKL—Modular

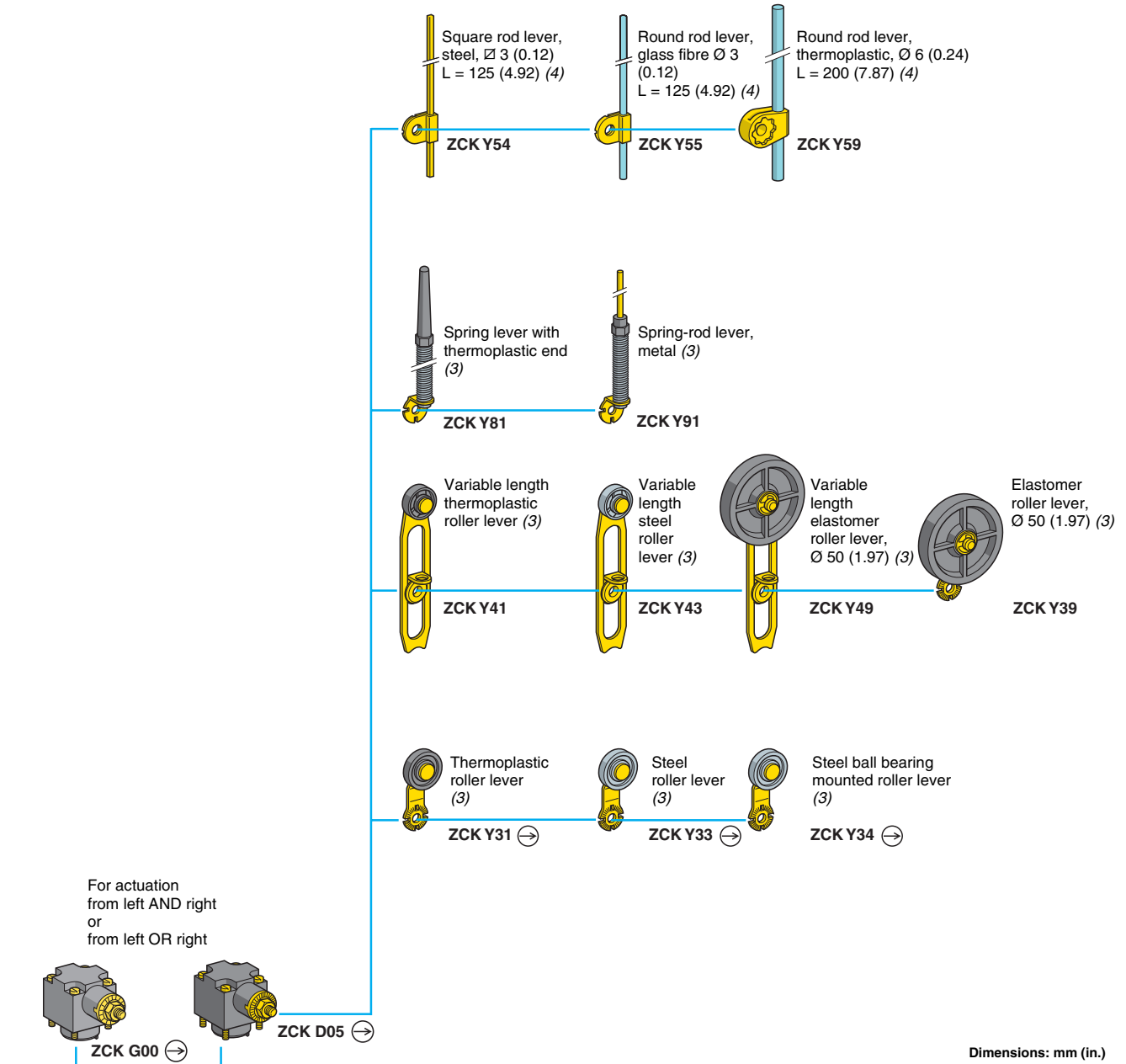

⊙ head assuring positive opening operation, when properly mounted and using a conforming operator.

- 3. Adjustable throughout 360° in 5° steps, or in 90° steps by reversing the notched washer.
- 4. Adjustable throughout 360° in 5° steps, or in 45° steps by reversing the lever mounting.

Limit Switches

Osiswitch® Classic, Metal

XCKM and XCKL—Modular

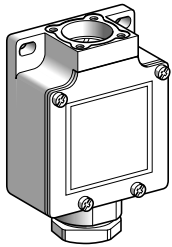
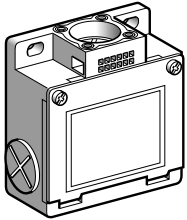

Limit Switches

Bodies with 2-pole contact					
With contact block	Function diagram	Positive operation (1)	Cable entry	Catalog number	Weight kg (lb)
For limit switches type XCKM					
N/C + N/O snap action (XE2S P2151)			1/2" NPT (2)	ZCKM1	0.210 (0.463)
			ISO M20 x 1.5	ZCKM1H29	0.210 (0.463)
N/C + N/O break before make, slow break (XE2N P2151)			1/2" NPT (2)	ZCKM5	0.210 (0.463)
			ISO M20 x 1.5	ZCKM5H29	0.210 (0.463)
N/O + N/C make before make, slow break (XE2N P2161)			1/2" NPT (2)	ZCKM6	0.210 (0.463)
			ISO M20 x 1.5	ZCKM6H29	0.210 (0.463)
N/C + N/C simultaneous, slow break (XE2N P2141)			1/2" NPT (2)	ZCKM7	0.210 (0.463)
			ISO M20 x 1.5	ZCKM7H29	0.210 (0.463)
N/O + N/O simultaneous, slow break (XE2N P2131)		—	1/2" NPT (2)	ZCKM8	0.210 (0.463)
			ISO M20 x 1.5	ZCKM8H29	0.210 (0.463)
N/C + N/C snap action (XE2S P2141)			ISO M20 x 1.5	ZCKM9H29	0.210 (0.463)
For limit switches type XCK L					
N/C + N/O snap action (XE2S P2151)			1/2" NPT	ZCKL1	0.210 (0.463)
N/C + N/O break before make, slow break (XE2N P2151)			1/2" NPT	ZCKL5	0.210 (0.463)
N/O + N/C make before make, slow break (XE2N P2161)			1/2" NPT	ZCKL6	0.210 (0.463)
N/C + N/C simultaneous, slow break (XE2N P2141)			1/2" NPT	ZCKL7	0.210 (0.463)
N/O + N/O simultaneous, slow break (XE2N P2131)		—	1/2" NPT	ZCKL8	0.210 (0.463)

- : N/C contact with positive opening operation, when properly mounted and using a conforming operator.
- 3 PG 11 tapped entries, one with metal adapter for 1/2" NPT (USASB2-1) conduit (PG 8).

Limit Switches

Osiswitch® Classic, Metal

XCKM and XCKL—Modular

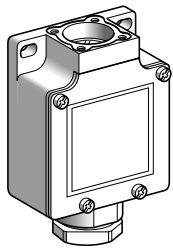
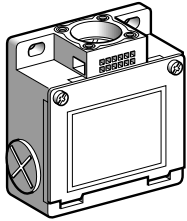

Bodies with 3-pole contact					
With contact block	Function diagram	Positive operation (1)	Cable entry	Catalog number	Weight kg (lb)
For limit switches type XCKM					
N/C + N/O + N/O snap action (XE3S P2151)			1/2" NPT (2)	ZCKMD31	0.210 (0.463)
			ISO M20 x 1.5	ZCKMD31H29	0.210 (0.463)
N/C + N/C + N/O snap action (XE3S P2141)			1/2" NPT (2)	ZCKMD39	0.210 (0.463)
			ISO M20 x 1.5	ZCKMD39H29	0.210 (0.463)
N/C + N/C + N/O break before make, slow break (XE3N P2141)			1/2" NPT (2)	ZCKMD37	0.210 (0.463)
			ISO M20 x 1.5	ZCKMD37H29	0.210 (0.463)
N/C + N/O + N/O break before make, slow break (XE3N P2151)			1/2" NPT (2)	ZCKMD35	0.210 (0.463)
			ISO M20 x 1.5	ZCKMD35H29	0.210 (0.463)
For limit switches type XCK L					
N/C + N/O + N/O snap action (XE3S P2151)			1/2" NPT	ZCKLD31	0.210 (0.463)
N/C + N/C + N/O snap action (XE3S P2141)			1/2" NPT	ZCKLD39	0.210 (0.463)
N/C + N/C + N/O break before make, slow break (XE3N P2141)			1/2" NPT	ZCKLD37	0.210 (0.463)
N/C + N/O + N/O break before make, slow break (XE3N P2151)			1/2" NPT	ZCKLD35	0.210 (0.463)

1. : N/C contact with positive opening operation, when properly mounted and using a conforming operator.
2. 3 PG 11 tapped entries, one with metal adapter for 1/2" NPT (USASB2-1) conduit (PG 8).

Limit Switches

Osiswitch® Classic, Metal

XCKM and XCKL—Modular

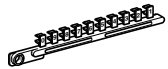
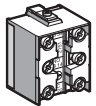
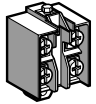
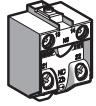

Contact blocks					
Type of contact	Function diagram	For bodies	Positive operation (1)	Catalog number	Weight kg (lb)
2-pole contact					
N/C + N/O snap action		ZCKM1 ZCKL1	⊖	XE2SP2151	0.020 (0.044)
N/C + N/O break before make, slow break		ZCKM5 ZCKL5	⊖	XE2NP2151	0.020 (0.044)
N/O + N/C make before break, slow break		ZCKM6 ZCKL6	⊖	XE2NP2161	0.020 (0.044)
N/C + N/C simultaneous, slow break		ZCKM7 ZCKL7	⊖	XE2NP2141	0.020 (0.044)
N/O + N/O simultaneous, slow break		ZCKM8 ZCKL8	—	XE2NP2131	0.020 (0.044)
N/C + N/C snap action		ZCKM9	⊖	XE2SP2141	0.020 (0.044)
3-pole contact					
N/C + N/O + N/O snap action		ZCKMD31 ZCKLD31	⊖	XE3SP2151	0.035 (0.077)
N/C + N/C + N/O snap action		ZCKMD39 ZCKLD39	⊖	XE3SP2141	0.035 (0.077)
N/C + N/C + N/O break before make, slow break		ZCKMD37 ZCKLD37	⊖	XE3NP2141	0.035 (0.077)
N/C + N/O + N/O break before make, slow break		ZCKMD35 ZCKLD35	⊖	XE3NP2151	0.035 (0.077)

1. ⊖: N/C contact with positive opening operation or sub-assembly assuring positive opening operation when properly mounted and using a conforming operator.

Accessories for limit switches type XCKM

Description	Sold in lots of	Unit catalog number	Weight kg (lb)
Tap-off terminal for cabling continuity	1	XCKZ09	0.010 (0.022)
Clip-in markers (strips of 10 numbers: 0 to 9) Other markers, please consult your local sales office.	25	AB1R11	0.002 (0.004)

Other versions

Gold flashed contacts.
Please consult your local sales office.

Limit Switches

Osiswitch® Classic, Metal

XCKM and XCKL—Modular

Heads ZCKD10, D109 with body	ZCKM1, L1 	ZCKM5, L5 	ZCKM6, L6 	ZCKM7, L7 	ZCKM8, L8
	ZCKM9 	ZCKMD39, LD39 	ZCKMD37, LD37 	ZCKMD31, LD31 	ZCKMD35, LD35
Heads ZCKD02, D029 with body	ZCKM1, L1 	ZCKM5, L5 	ZCKM6, L6 	ZCKM7, L7 	ZCKM8, L8
	ZCKM9 	ZCKMD39, LD39 	ZCKMD37, LD37 	ZCKMD31, LD31 	ZCKMD35, LD35
Heads ZCKD21, D23, D219, D239 with body	ZCKM1, L1 	ZCKM5, L5 	ZCKM6, L6 	ZCKM7, L7 	ZCKM8, L8
	ZCKM9 	ZCKMD39, LD39 	ZCKMD37, LD37 	ZCKMD31, LD31 	ZCKMD35, LD35
Heads ZCKD15, D16, D17 with body	ZCKM1, L1 	ZCKM5, L5 	ZCKM6, L6 	ZCKM7, L7 	ZCKM8, L8
	ZCKM9 	ZCKMD39, LD39 	ZCKMD37, LD37 	ZCKMD31, LD31 	ZCKMD35, LD35
Heads ZCKD41, D59, D81, D91 with body	ZCKM1, L1 	ZCKM5, L5 	ZCKM6, L6 	ZCKM7, L7 	ZCKM8, L8
	ZCKM9 	ZCKMD39, LD39 	ZCKMD37, LD37 	ZCKMD31, LD31 	ZCKMD35, LD35
Heads ZCKD06, D08 with body	ZCKM1, L1 	ZCKM5, L5 	ZCKM6, L6 	ZCKM7, L7 	ZCKM8, L8
	ZCKM9 	ZCKMD39, LD39 	ZCKMD37, LD37 	ZCKMD31, LD31 	ZCKMD35, LD35

Contact operation

■ contact closed
□ contact open

(A) = cam displacement
(P) = positive opening point

Limit Switches

Osiswitch® Classic, Metal

XCKM and XCKL—Modular

Bodies with contacts

ZCKM1, M5, M6, M7, M8,
ZCKM1H29, M5H29, M6H29, M7H29, M8H29, M9H29

ZCKL1, L5, L6, L7, L8, LD3• (5)

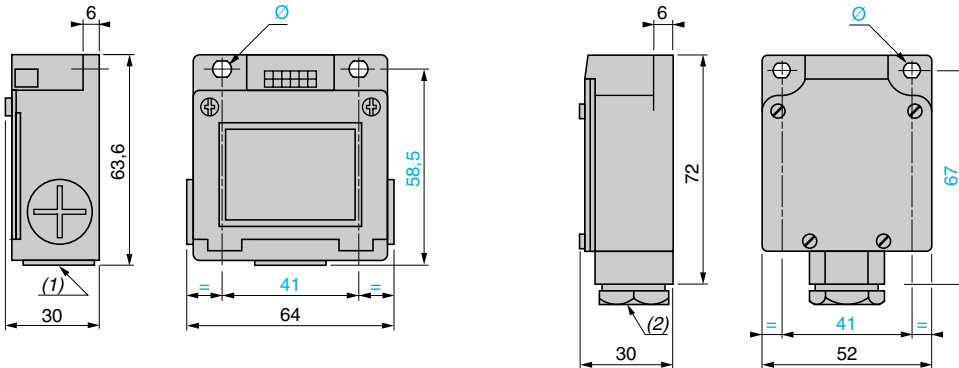

Adapter for 1/2" NPT conduit

DE9RA1012

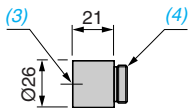

1. 3 tapped entries for ISO M20 x 1.5 or PG 11 conduit thread.
2. Incorporated cable entry.
- Ø: 2 elongated holes Ø 5.2 x 6.2.
3. Tapped entry for 1/2" NPT conduit.
4. Threaded sleeve, PG 11.
5. XCKL provided with 1/2" NPT adapter shown above, DE9RA1012.

Complete Switches

For interpreting the complete switch catalog number only

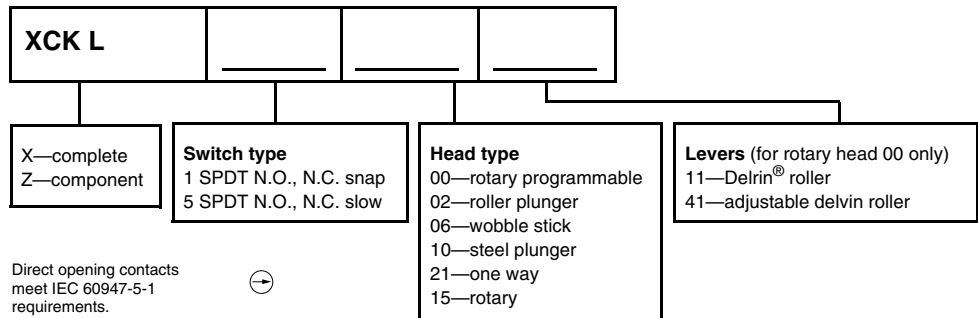

NOTE: Some combinations are not available. Use this information to interpret catalog numbers, not to create them.

Limit Switches

Osiswitch® Classic, Metal

XCKM and XCKL—Modular

Plunger heads

ZCKD10

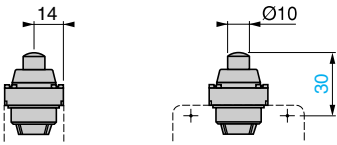

ZCKD109

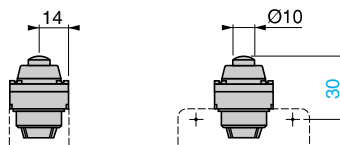

ZCKD02

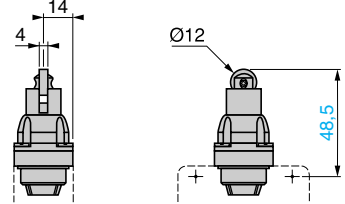

ZCKD029

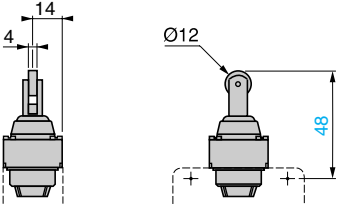

ZCKD21, D23

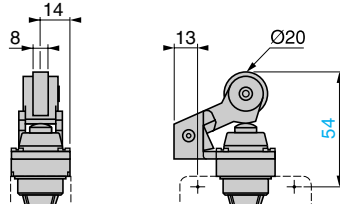

ZCKD219, D239

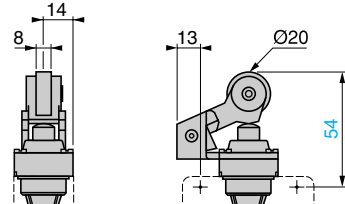

Rotary heads

ZCKD15, D16, D17

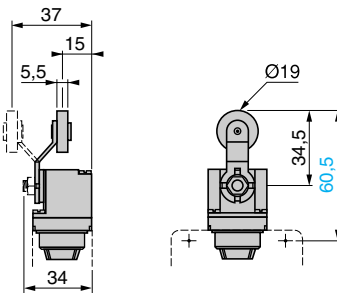

ZCKD41

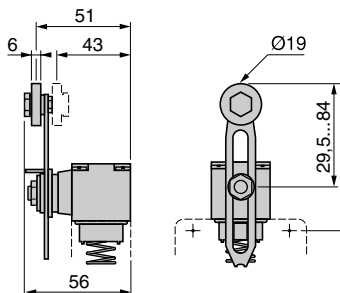

ZCKD59

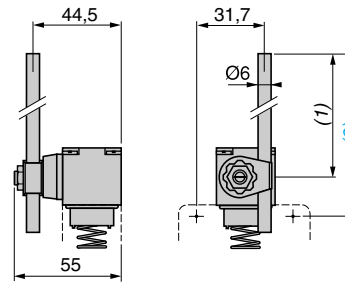

ZCKD81

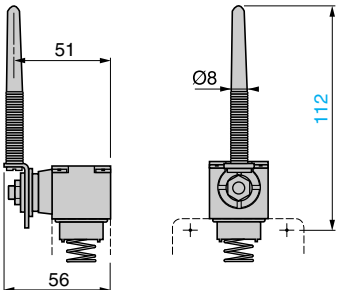

ZCKD91

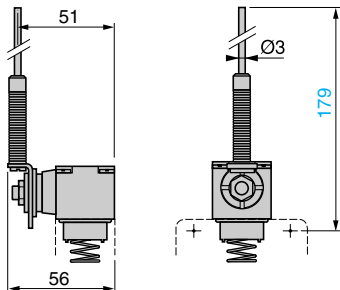

ZCKG00

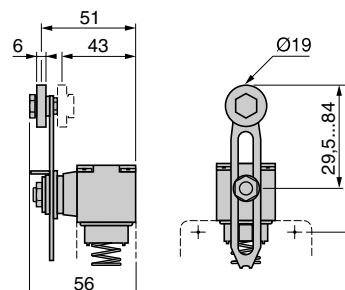

Multi-directional heads

ZCKD06

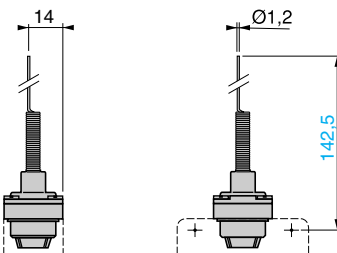

ZCKD08

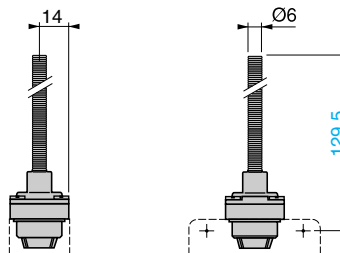

1. 190 max.
2. 215.5 max.











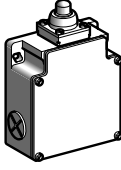
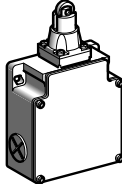
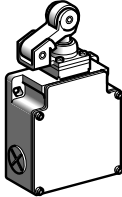
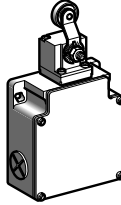



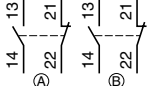
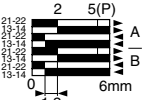
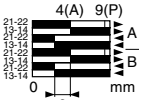
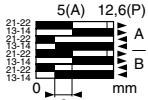
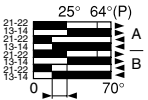



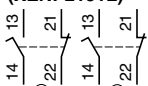
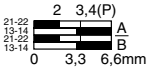
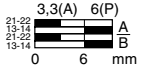
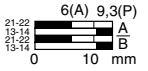
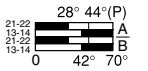



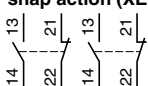
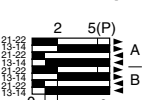
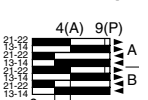

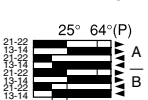

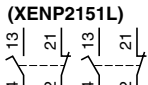
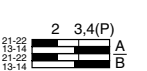

NOTE: operating lever spindle threaded M6.

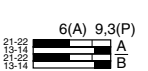
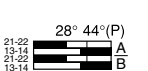
Limit Switches

Limit Switches

Osiswitch® Classic, Metal

XCKML, 2 x 2-Pole Contacts—Complete Switches

Type of head	Plunger (mounting by the body)			Rotary (mounting by the body)	
					
Type of operator	Metal end plunger	Steel roller plunger	Thermoplastic roller lever plunger, horizontal actuation in 1 direction	Thermoplastic roller lever (1)	
Catalog numbers (2)					
Switches with 3 entries tapped ISO M20 x 1.5					
2 x 2-pole N/C + N/O snap action (XESP2151L)	XCKML110H29 	XCKML102H29 	XCKML121H29 	XCKML115H29 	
					
2 x 2-pole N/C + N/O break before make, slow break (XENP2151L)	XCKML510H29 	XCKML502H29 	XCKML521H29 	XCKML515H29 	
					
Switches with 3 entries tapped for PG 13 conduit thread, plus adapter for 1/2" NPT					
2 x 2-pole N/C + N/O snap action (XESP2151L)	XCKML110 	XCKML102 	XCKML121 	XCKML115 	
					
2 x 2-pole N/C + N/O break before make, slow break (XENP2151L)	XCKML510 	XCKML502 	XCKML521 	XCKML515 	
					
Weight, kg (lb)	0.400 (0.882)	0.405 (0.893)	0.450 (0.992)	0.430 (0.948)	
Contact operation	 contact closed  contact open	(A) = cam displacement (P) = positive opening point	 N/C contact with positive opening operation, when properly mounted and using a conforming operator		
Characteristics					
Switch actuation	On end	By 30° cam			
Type of actuation					
Maximum actuation speed	0.5 m/s (1.64 ft/s)		1.5 m/s (4.92 ft/s)		
Minimum force	For tripping	15 N (3.37 lb)	12 N (2.70 lb)	8 N (1.80 lb)	0.2 N•m (1.77 lb-in)
	For positive opening	60 N (13.49 lb)	50 N (11.24 lb)	50 N (11.24 lb)	0.5 N•m (4.43 lb-in)
Cable entry	3 entries tapped ISO M20 x 1.5, clamping capacity 7 to 13 mm (0.28 to 0.51 in.); or 3 entries tapped for PG 13 conduit thread conforming to NF C 68-300 (DIN PG 13.5), clamping capacity 9 to 12 mm (0.35 to 0.47 in.) (0.35 to 0.47 in.), plus adapter for 1/2" NPT				

- Adjustable throughout 360° in 5° steps, or in 90° steps by reversing the notched washer.
- Switches available with other 2-pole slow break contact blocks: N/O + N/C make before break, N/C + N/C simultaneous (with positive opening operation, when properly mounted and using a conforming operator), N/C + N/C simultaneous, please consult your local sales office.

Replacement parts

The heads of limit switches type XCKML are the same as those for types XCKM and XCKL (see heads ZCKD10, ZCKD02, ZCKD21 and ZCKD15 on page 88).

Limit Switches

Osiswitch® Classic, Metal

XCKML, 2 x 2-Pole Contacts—Complete Switches

XCKML110H29, XCKML510H29, XCKML110, XCKML510

XCKML102H29, XCKML502H29, XCKML102, XCKML502

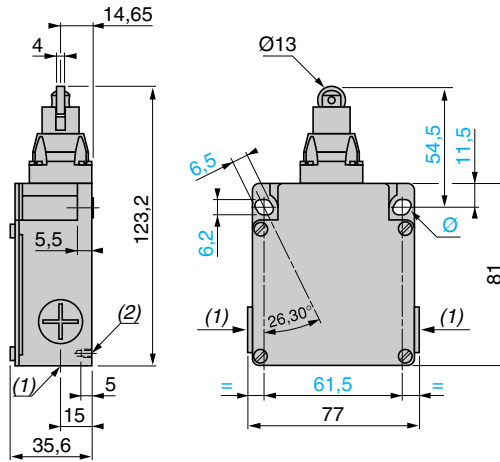
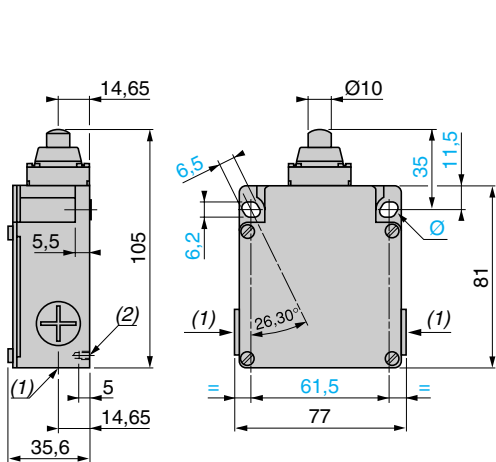

XCKML121H29, XCKML521H29, XCKML121, XCKML521

XCKML115H29, XCKML515H29, XCKML115, XCKML515

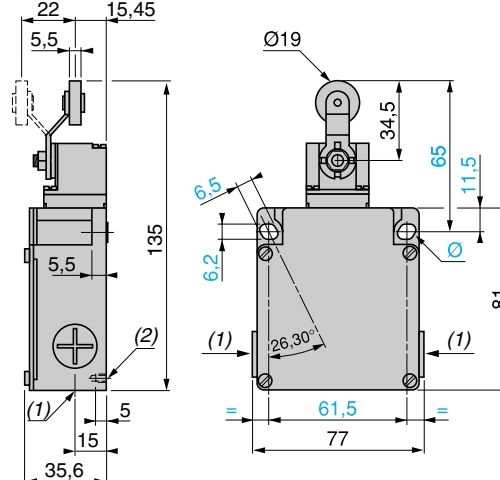
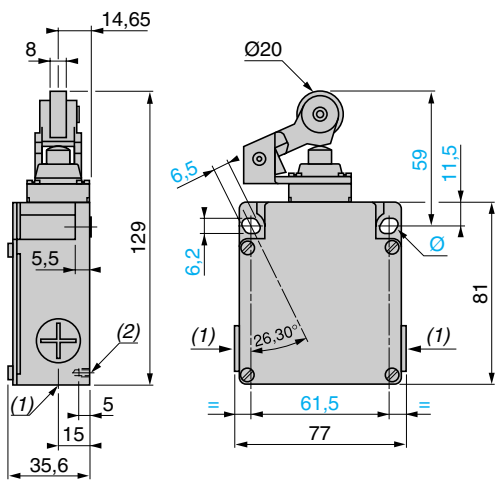

1. XCKML***H29: 3 entries tapped M20 x 1.5. XCKML***: 3 entries tapped for PG 13 conduit thread (adapter DE9RA1212 for 1/2" NPT available).
 2. 2 centering holes $\varnothing 3.9 \pm 0.2$, cover mounting holes axis.
- Ø: 2 elongated holes 6.2 x 6.5, inclined at 26°30' to the vertical axis, for M5 screws.

DE9RA1212 (PG 13 to 1/2" NPT adapter)

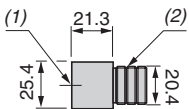

1. Tapped entry for 1/2" NPT conduit
2. PG 13 threaded sleeve

Limit Switches

Osiswitch® Classic, Metal, Conforming to CENELEC EN 50041

XCKJ

■ XCKJ
fixed, non-plug-in body with 1 cable entry

□ With head for linear movement (plunger)

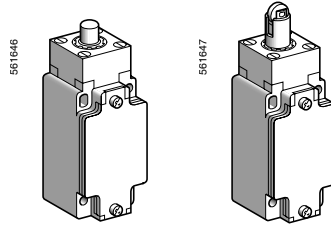

Page 100

□ With head for rotary movement (lever) or multi-directional

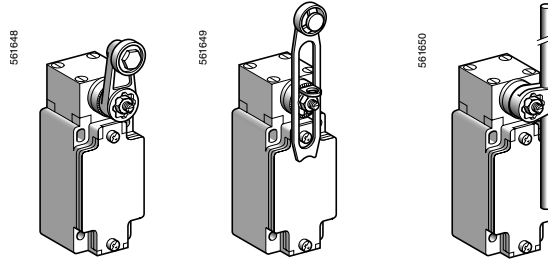

Page 100

■ XCKJ
plug-in body with 1 cable entry

□ With head for linear movement (plunger)

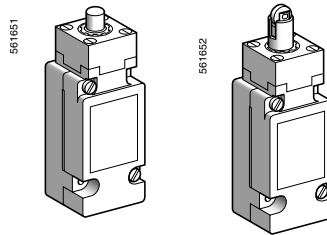

Page 102

□ With head for rotary movement (lever)

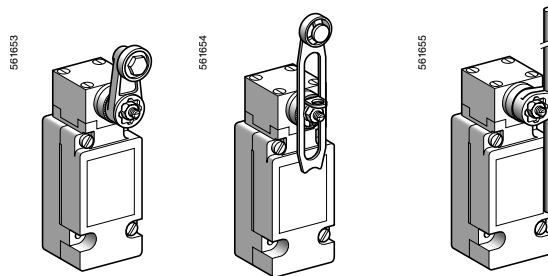

Page 102

Environmental characteristics

Conforming to standards	Products	IEC 60947-5-1, EN 60947-5-1, UL 508, CSA C22-2 n° 14
	Machine assemblies	IEC 60204-1, EN 60204-1
Product certifications		UL, CSA, CCC
Protective treatment	Version	Standard "TC", special "TH"
Ambient air temperature	Operation	- 25...+70 °C (-13...+158 °F), special sub-assemblies available for extreme temperatures: -40 °C (-40 °F) or +120 °C (248 °F)
	Storage	- 40...+70 °C (-40...+158 °F)
Vibration resistance	Conforming to IEC 60068-2-6	25 gn (10...500 Hz)
Shock resistance	Conforming to IEC 60068-2-27	50 gn (11 ms)
Electric shock protection		Class I conforming to IEC 61140 and NF C 20-030
Degree of protection		NEMA Types 1, 2, 4, 12; IP 66 conforming to IEC 60529; IK 07 conforming to EN 50 102
Repeat accuracy		0.01 mm on the tripping points, with 1 million operating cycles for head with end plunger
Cable entry or integral connector	Depending on model	Tapped entry for PG 13 conduit thread, or tapped ISO M20 x 1.5 or 1/2" NPT, or M12 connector
Materials		Bodies and heads in Zamak® zinc alloy

Limit Switches

Osiswitch® Classic, Metal, Conforming to CENELEC EN 50041

XCKJ

Contact block characteristics		
Rated operational characteristics	XE2•P	~ AC-15; A300 (Ue = 240 V, Ie = 3 A); Ithe = 10 A = DC-13; Q300 (Ue = 250 V, Ie = 0.27 A), conforming to IEC 60947-5-1 appendix A, EN 60947-5-1
	XE3•P	~ AC-15; B300 (Ue = 240 V, Ie = 1.5 A); Ithe = 6 A = DC-13; R300 (Ue = 250 V, Ie = 0.1 A), conforming to IEC 60947-5-1 appendix A, EN 60947-5-1
Rated insulation voltage	XE2•P	Ui = 500 V degree of pollution 3 conforming to IEC 60947-1 Ui = 300 V conforming to UL 508, CSA C22-2 n° 14
	XE3•P	Ui = 400 V degree of pollution 3 conforming to IEC 60947-1 Ui = 300 V conforming to UL 508, CSA C22-2 n° 14
Rated impulse withstand voltage	XE2•P	U imp = 6 kV conforming to IEC 60947-1, IEC 60664
	XE3•P	U imp = 4 kV conforming to IEC 60947-1, IEC 60664
Positive operation (depending on model)		N/C contacts with positive opening operation conforming to IEC 60947-5-1 Appendix K, EN 60947-5-1
Resistance across terminals		≤ 25 mΩ conforming to IEC 60255-7 category 3
Short-circuit protection	XE2•P	10 A cartridge fuse type gG (gl)
	XE3•P	6 A cartridge fuse type gG (gl)
Cabling (screw clamp terminals)	XE2SP21•1	Clamping capacity, min: 1 x 0.34 mm ² , max: 2 x 1.5 mm ²
	XE2NP21•1	Clamping capacity, min: 1 x 0.5 mm ² , max: 2 x 2.5 mm ²
	XCKJ plug-in and XESP20•1	Clamping capacity, min: 1 x 0.75 mm ² , max: 2 x 1.5 mm ²
	XE3NP and XE3SP	Clamping capacity, min: 1 x 0.34 mm ² , max: 1 x 1 mm ² or 2 x 0.75 mm ²
Minimum actuation speed		XE2SP21•1 and XE3SP: 0.01 m/minute (0.03 ft/minute)
		XE2NP21•1 and XE3NP: 6 m/minute (19.68 ft/minute)

- Electrical durability**
- Conforming to IEC 60947-5-1 Appendix C
 - Utilization categories AC-15 and DC-13
 - Maximum operating rate: 3600 operating cycles/hour
 - Load factor: 0.5

XE2SP21•1, XE2SP2141

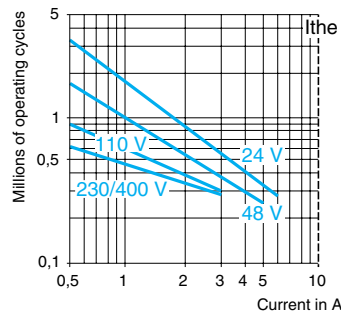

a.c. supply
~ 50/60 Hz
~ inductive circuit

XE2NP21•1

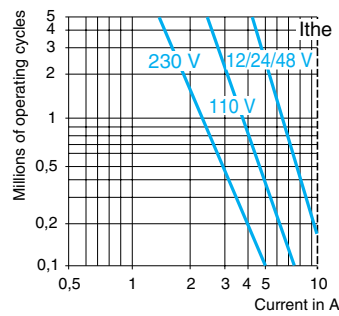

XCKJ plug-in, XESP20•1

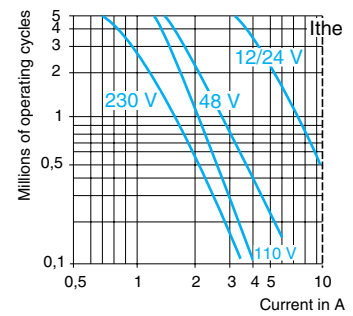

d.c. supply =

Power switched in W for 5 million operating cycles.

Voltage	V	24	48	120
mm	W	10	7	4

Power switched in W for 5 million operating cycles.

Voltage	V	24	48	120
mm	W	13	9	7

Power switched in W for 5 million operating cycles.

Voltage	V	24	48	120
mm	W	10	7	4

XE3NP***

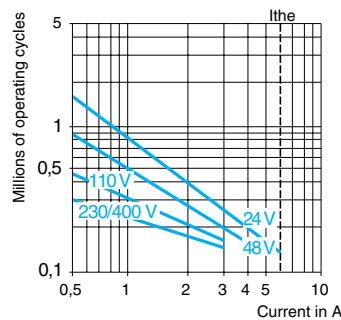

a.c. supply
~ 50/60 Hz
~ inductive circuit

XE3SP***

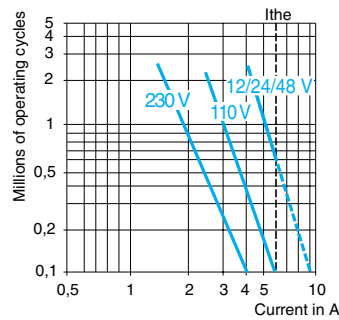

d.c. supply =

Power switched in W for 5 million operating cycles.











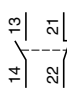
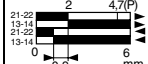



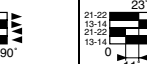

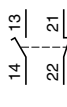
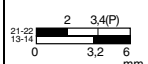
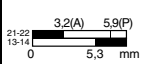
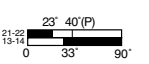
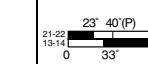
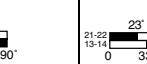

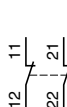

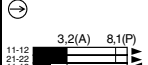

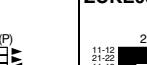

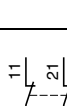
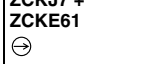
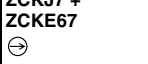
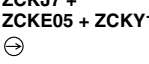

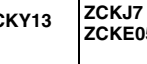

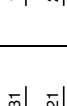
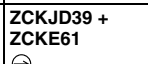
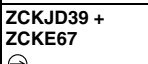
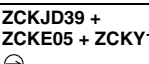

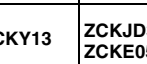
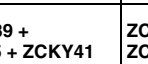
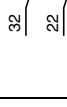
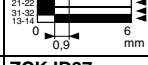
Voltage	V	24	48	120
mm	W	3	2	1

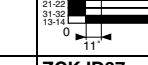
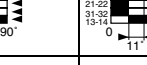
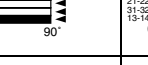
Power switched in W for 5 million operating cycles.

Voltage	V	24	48	120
mm	W	4	3	2

Limit Switches

Osiswitch® Classic, Metal, Conforming to CENELEC EN 50041 XCKJ—Complete Switches, Fixed Non-plug-in Body, 1/2" NPT Cable Entry

Type of head	Plunger (mounting by the body)			Rotary (mounting by the body) (switches supplied for actuation from left AND right)		
	Form B (1)	Form C (1)	Form A (1)			Form D (1)
Type of operator	Metal end plunger	Steel roller plunger	Thermoplastic roller lever (3)	Steel roller lever (3)	Variable length thermoplastic roller lever (3)	Round thermoplastic rod lever, Ø 6 mm (0.24 in.) (3) (4)
Catalog numbers (2)	XCKJ161	XCKJ167	XCKJ10511	XCKJ10513	XCKJ10541	XCKJ10559
 2-pole N/C + N/O snap action (XE2S P2151)	 XCKJ161	 XCKJ167	 XCKJ10511	 XCKJ10513	 XCKJ10541	 XCKJ10559
 2-pole N/C + N/O break before make, slow break (XE2N P2151)	 XCKJ561	 XCKJ567	 XCKJ50511	 XCKJ50513	 XCKJ50541	 XCKJ50559
 2-pole N/C + N/C snap action (XE2S P2141)	 ZCKJ9 + ZCKE61	 ZCKJ9 + ZCKE67	 ZCKJ9 + ZCKE05 + ZCKY11	 ZCKJ9 + ZCKE05 + ZCKY13	 ZCKJ9 + ZCKE05 + ZCKY41	 ZCKJ9 + ZCKE05 + ZCKY59
 2-pole N/C + N/C simultaneous, slow break (XE2N P2141)	 ZCKJ7 + ZCKE61	 ZCKJ7 + ZCKE67	 ZCKJ7 + ZCKE05 + ZCKY11	 ZCKJ7 + ZCKE05 + ZCKY13	 ZCKJ7 + ZCKE05 + ZCKY41	 ZCKJ7 + ZCKE05 + ZCKY59
 3-pole N/C + N/C + N/O snap action (XE3S P2141)	 ZCKJD39 + ZCKE61	 ZCKJD39 + ZCKE67	 ZCKJD39 + ZCKE05 + ZCKY11	 ZCKJD39 + ZCKE05 + ZCKY13	 ZCKJD39 + ZCKE05 + ZCKY41	 ZCKJD39 + ZCKE05 + ZCKY59
 3-pole N/C + N/C + N/O break before make, slow break (XE3N P2141)	 ZCKJD37 + ZCKE61	 ZCKJD37 + ZCKE67	 ZCKJD37 + ZCKE05 + ZCKY11	 ZCKJD37 + ZCKE05 + ZCKY13	 ZCKJD37 + ZCKE05 + ZCKY41	 ZCKJD37 + ZCKE05 + ZCKY59
Weight, kg (lb)	0.430 (0.948)	0.455 (1.003)	0.480 (1.058)	0.490 (1.080)	0.485 (1.069)	0.485 (1.069)
Contact operation	 contact closed  contact open			(A) = cam displacement (P) = positive opening point	 N/C contact with positive opening operation, when properly mounted and using a conforming operator	
Characteristics						
Switch actuation	On end	By 30° cam			By any moving part	
Type of actuation						
Maximum actuation speed	0.5 m/s (1.64 ft/s)	1 m/s (3.28 ft/s)	1.5 m/s (4.92 ft/s)			
Minimum force or torque	For tripping: 20 N (4.50 lb) For positive opening: 50 N (11.24 lb)	16 N (3.60 lb) 40 N (8.99 lb)	0.25 N•m (2.21 lb-in) 0.50 N•m (4.43 lb-in)			—
Cable entry	1 entry tapped 1/2" NPT for ISO cable entry, clamping capacity 9 to 12 mm (0.35 to 0.47 in.)					

- Form conforming to EN 50041. See page 23.
- Switches with gold contacts or eyelet type connections: please consult your local sales office.
- Adjustable throughout 360° in 5° steps, or in 45° steps by reversing the lever or its mounting.
- Value taken with actuation by moving part at 100 mm (3.94 in.) from the mounting.

Limit Switches

Osiswitch® Classic, Metal, Conforming to CENELEC EN 50041

XCKJ—Complete Switches, Fixed Non-plug-in Body, 1/2" NPT Cable Entry

XCKJ•61
ZCKJ•+ ZCKE61

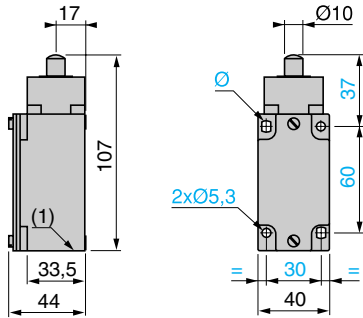

XCKJ•67
ZCKJ•+ ZCKE67

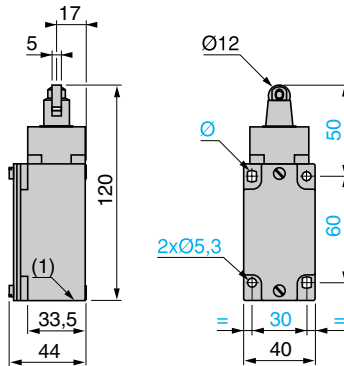

XCKJ•051•
ZCKJ•+ ZCKE05 + ZCKY11 or Y13

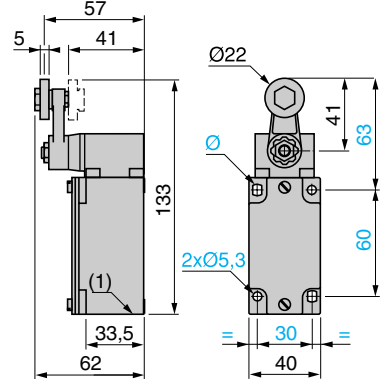

XCKJ•0541
ZCKJ•+ ZCKE05 + ZCKY41

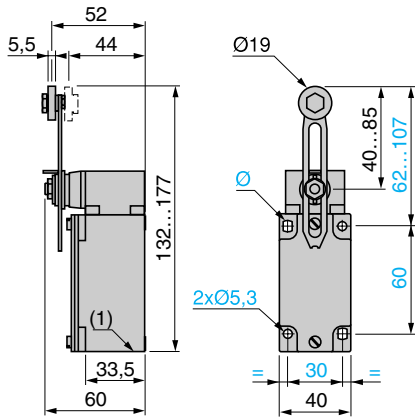

XCKJ•0559
ZCKJ•+ ZCKE05 + ZCKY59

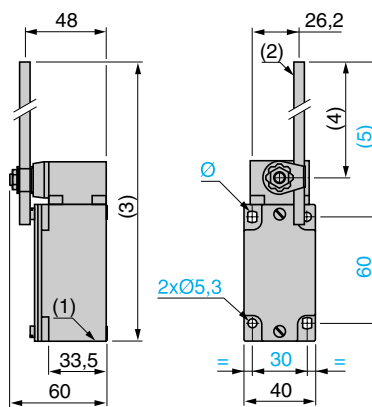

1. 1 tapped entry for 1/2" NPT.
2. Rod Ø 6 mm (0.24 in.), length 200 mm (7.87 in.).
3. 282 max.
4. 190 max.
5. 212 max.
- Ø: 2 elongated holes Ø 5.3 x 7.3.

For Interpretation of the Complete Switch Catalog Number Only

Note: See following pages for the complete switch offering

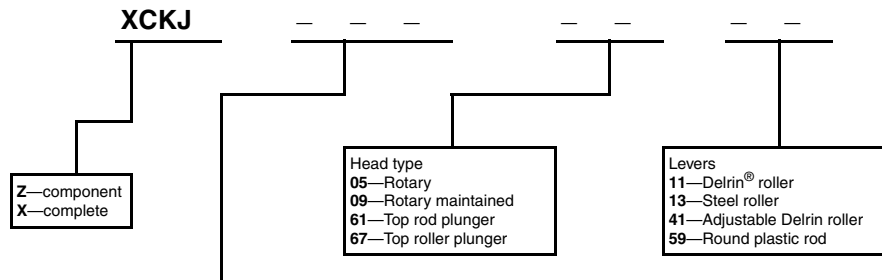







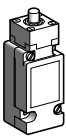
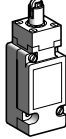

Switch type	
1	SPDT Non-plug-in
2	2SPDT Non-plug-in
4	2SPDT Non-plug-in for 2 step or neutral position
5	SPDT Non-plug-in slow make slow break
8	SPDT Gold Contacts
11	SPDT Plug-in
21	2SPDT Plug-in
41	2SPDT Plug-in for 2 step or neutral position

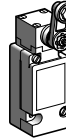
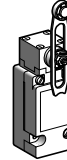
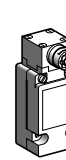
Limit Switches

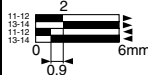
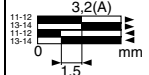
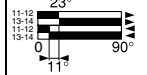
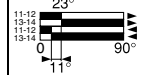
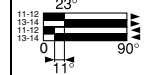
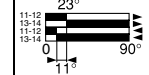
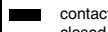
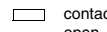
Osiswitch® Classic, Metal, Conforming to CENELEC EN 50041

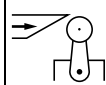
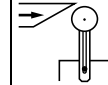
XCKJ—Complete Switches, Plug-in Body, 1/2" NPT Cable Entry

Type of head	Plunger (mounting by the body)		Rotary (mounting by the body) (switches supplied for actuation from left AND right)			
	Form B (1)	Form C (1)	Form A (1)		Form D (1)	
						
Type of operator	Metal end plunger	Steel roller plunger	Thermoplastic roller lever (3)	Steel roller lever (3)	Variable length thermoplastic roller lever (3)	Round thermoplastic rod lever, Ø 6 mm (0.24 in.) (3) (4)
Catalog numbers (2)						
 Single-pole C/O snap action	XCKJ1161	XCKJ1167	XCKJ110511	XCKJ110513	XCKJ110541	XCKJ110559
						
Weight, kg (lb)	0.430 (0.948)	0.455 (1.003)	0.480 (1.058)	0.490 (1.080)	0.485 (1.069)	0.485 (1.069)
Contact operation	 contact closed  contact open		(A) = cam displacement			
Characteristics						
Switch actuation	On end	By 30° cam			By any moving part	
Type of actuation						
Maximum actuation speed	0.5 m/s (1.64 ft/s)	1 m/s (3.28 ft/s)	1.5 m/s (4.92 ft/s)			
Minimum force or torque for tripping	20 N (4.50 lb)	16 N (3.60 lb)	0.25 N•m (2.21 lb-in)			
Cable entry	1 entry tapped for 1/2" NPT cable entry. Clamping capacity 7 to 13 mm (0.28 to 0.51 in.)					

1. Form conforming to EN 50041. See page 23.
2. Switches with gold contacts: please consult your local sales office.
3. Adjustable throughout 360° in 5° steps, or in 45° steps by reversing the lever mounting or clamp.
4. Value taken with actuator operating at 100 mm (3.94 in.) from the mounting.

Limit Switches

Osiswitch® Classic, Metal, Conforming to CENELEC EN 50041

XCKJ—Complete Switches, Plug-in Body, 1/2" NPT Cable Entry

XCKJ1611

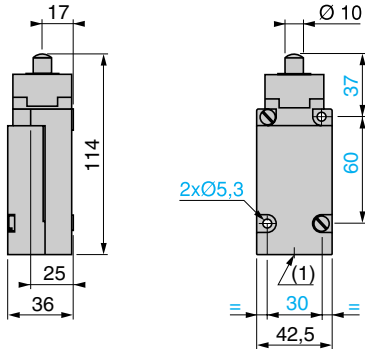

XCKJ1167

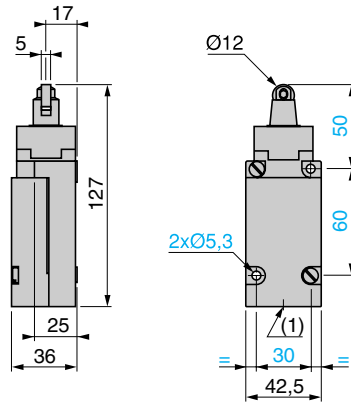

XCKJ110511, XCKJ110513

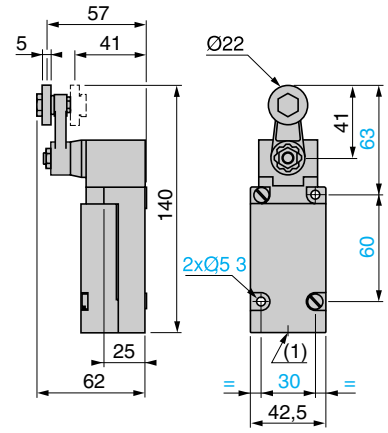

XCKJ110541

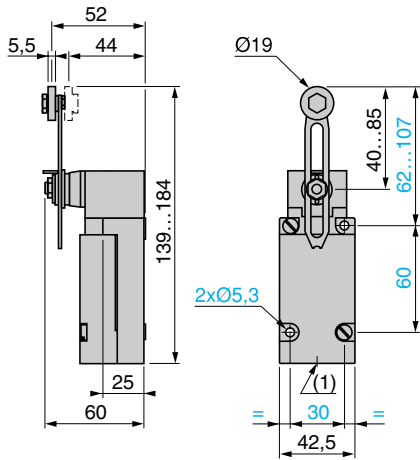

XCKJ110559

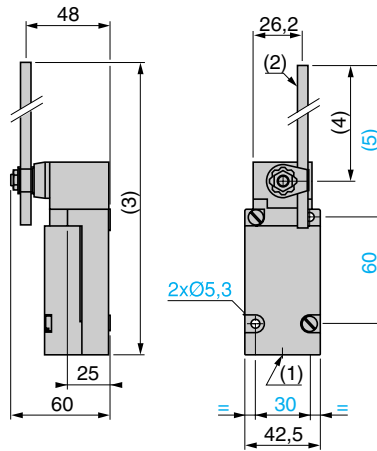









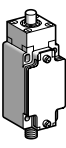
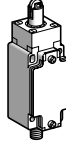
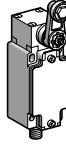
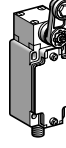

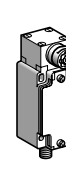

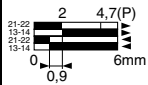
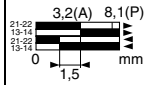
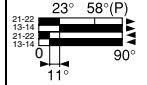
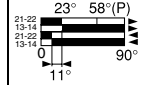
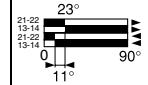
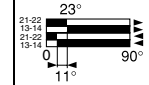
1. Tapped entry for 1/2" NPT conduit.
2. Rod Ø 6 mm (0.24 in.), length 200 mm (7.87 in.).
3. 289 max.
4. 190 max.
5. 212 max.

Limit Switches

Osiswitch® Classic, Metal, Conforming to CENELEC EN 50041

XCKJ—Complete Switches, Fixed Non-plug-in Body, Integral M12 Connector

Type of head	Plunger (mounting by the body)		Rotary (mounting by the body) (switches supplied for actuation from left AND right)			
	Form B (1)	Form C (1)	Form A (1)			Form D (1)
						
Type of operator	Metal end plunger	Steel roller plunger	Thermoplastic roller lever (2)	Steel roller lever (2)	Variable length thermoplastic roller lever (2)	Round thermoplastic rod lever, Ø 6 mm (0.24 in.) (2) (3)
Catalog numbers (4)						
 2-pole N/C + N/O snap action (XE2SP2151)	XCKJ161D 	XCKJ167D 	XCKJ10511D 	XCKJ10513D 	XCKJ10541D 	XCKJ10559D 
	Weight, kg (lb)	0.430 (0.948)	0.455 (1.003)	0.480 (1.058)	0.490 (1.080)	0.485 (1.069)
Contact operation	 contact closed  contact open		(A) = cam displacement (P) = positive opening point			
Characteristics						
Switch actuation	On end	By 30° cam			By any moving part	
Type of actuation						
Maximum actuation speed	0.5 m/s (1.64 ft/s)	1 m/s (3.28 ft/s)	1.5 m/s (4.92 ft/s)			
Minimum force or torque	For tripping	20 N (4.50 lb)	16 N (3.60 lb)	0.25 N•m (2.21 lb-in)		
	For positive opening	50 N (11.24 lb)	40 N (8.99 lb)	0.50 N•m (4.43 lb-in)		
Connection	M12 5-pin connector, U _i = 60 V, I _e = 4 A (see suitable pre-wired female connectors below).					

- Form conforming to EN 50041. See page 23.
- Adjustable throughout 360° in 5° steps, or in 45° steps by reversing the lever or its mounting.
- Value taken with actuation by moving part at 100 mm (3.94 in.) from the mounting.
- Switches with gold contacts: please consult your local sales office.

Catalog numbers of suitable pre-wired female connectors

Type of connector	Length (L)	M12 straight, 5-pin, 4 A/24 V max.	M12 elbowed, 5-pin, 4 A/24 V max.	Weight, kg (lb)
With cable, Ø 5.8 mm (0.23 in.) (4 x 0.34 mm ² + 1 x 0.5 mm ²)	2 m (6.56 ft)	XZCP1164L2	XZCP1264L2	0.115 (0.254)
	5 m (16.40 ft)	XZCP1164L5	XZCP1264L5	0.270 (0.595)
	10 m (32.8 ft)	XZCP1164L10	XZCP1264L10	0.520 (1.146)

Limit Switches

Osiswitch® Classic, Metal, Conforming to CENELEC EN 50041

XCKJ—Complete Switches, Fixed Non-plug-in Body, Integral M12 Connector

Dimensions

XCKJ161D

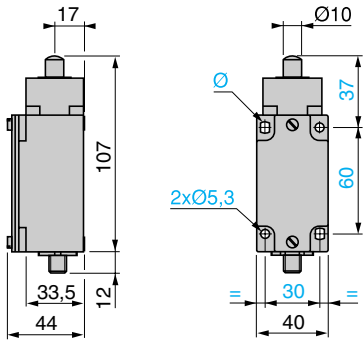

XCKJ167D

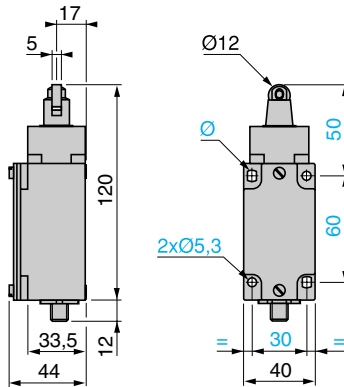

XCKJ1051•D

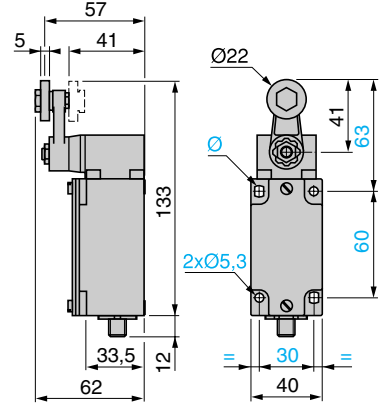

XCKJ10541D

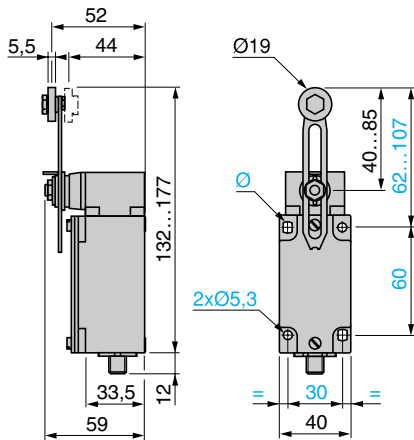

XCKJ10559D

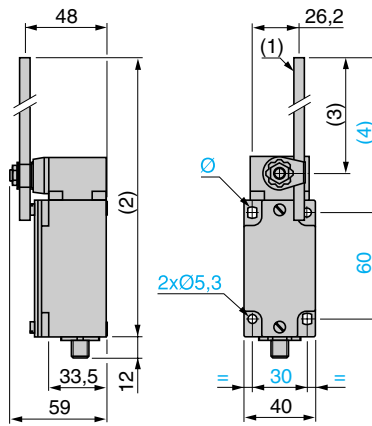

XZCP1164L•

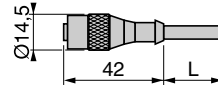

XZCP1264L•

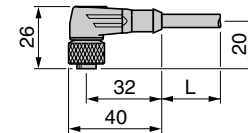

- 1. Rod Ø 6 mm (0.24 in.), length 200 mm (7.87 in.)
- 2. 282 max.
- 3. 190 max.
- 4. 212 max.
- Ø: 2 elongated holes Ø 5.3 x 7.3
- L: Cable length 2, 5, or 10 m (6.6, 16.4, or 32.8 ft)

Connections

Limit switch XCKJ••••D

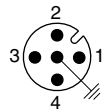

- 1-2 = N/C
- 3-4 = N/O
- 5 = ⊥
- 4 A / 24 V max.



Pre-wired female connector XZCP1•64L•

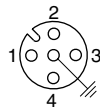









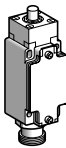
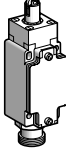
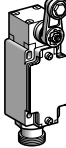
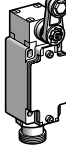
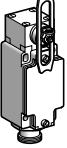
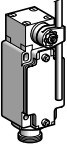

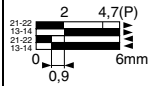
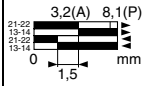
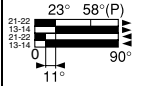
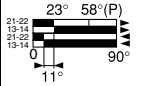
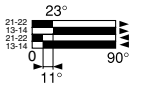
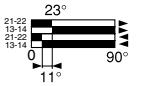
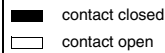
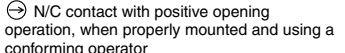
- 1 = brown
- 2 = white
- 3 = blue
- 4 = black
- 5 = ⊥ yellow/green

Limit Switches

Osiswitch® Classic, Metal, Conforming to CENELEC EN 50041

XCKJ—Complete Switches, Fixed Non-plug-in Body, Integral 7/8" 16UN connector

Type of head	Plunger (mounting by the body)		Rotary (mounting by the body) (switches supplied for actuation from left AND right)			
	Form B (1)	Form C (1)	Form A (1)		Form D (1)	
						
Type of operator	Metal end plunger	Steel roller plunger	Thermoplastic roller lever (2)	Steel roller lever (2)	Variable length thermoplastic roller lever (2)	Round thermoplastic rod lever, Ø 6 mm (0.24 in.) (2) (3)
Catalog numbers (4)						
 2-pole N/C + N/O snap action (XE2SP2151)	XCKJ161A 	XCKJ167A 	XCKJ10511A 	XCKJ10513A 	XCKJ10541A 	XCKJ10559A 
	Weight, kg (lb)	0.430 (0.948)	0.455 (1.003)	0.480 (1.058)	0.490 (1.080)	0.485 (1.069)
Contact operation	 contact closed  contact open		(A) = cam displacement (P) = positive opening point	 N/C contact with positive opening operation, when properly mounted and using a conforming operator		
Characteristics						
Switch actuation	On end	By 30° cam			By any moving part	
Type of actuation						
Maximum actuation speed	0.5 m/s (1.64 ft/s)	1 m/s (3.28 ft/s)	1.5 m/s (4.92 ft/s)			
Minimum force or torque	For tripping	20 N (4.50 lb)	16 N (3.60 lb)	0.25 N•m (2.21 lb-in)		
	For positive opening	50 N (11.24 lb)	40 N (8.99 lb)	0.50 N•m (4.43 lb-in)		
Connection	7/8" 16UN 5-pin connector, U _i = 250 V; I _e = 6 A (see suitable pre-wired female connectors below).					

- Form conforming to EN 50041. See page 23.
- Adjustable throughout 360° in 5° steps, or in 45° steps by reversing the lever mounting or clamp.
- Value taken with actuator operating at 100 mm (3.94 in.) from the mounting.
- Switches with gold contacts: please consult your local sales office.

Catalog numbers of suitable pre-wired female connectors

Type of connector	Length (L)	7/8" 16UN straight, 5-pin, 6 A/250 V max.	Weight, kg (lb)
With cable, Ø 6.7 mm (5 x 0.5 mm ²)	2 m (6.56 ft)	XZCP1771L2	0.190 (0.419)
	5 m (16.40 ft)	XZCP1771L5	0.475 (1.047)
	10 m (32.8 ft)	XZCP1771L10	0.950 (2.094)

Limit Switches

Osiswitch® Classic, Metal, Conforming to CENELEC EN 50041

XCKJ—Complete Switches, Fixed Non-plug-in Body, Integral 7/8" 16UN connector

Dimensions

XCKJ161A

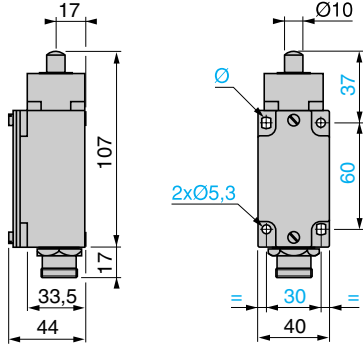

XCKJ167A

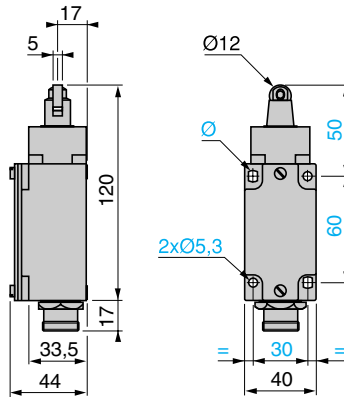

XCKJ1051•A

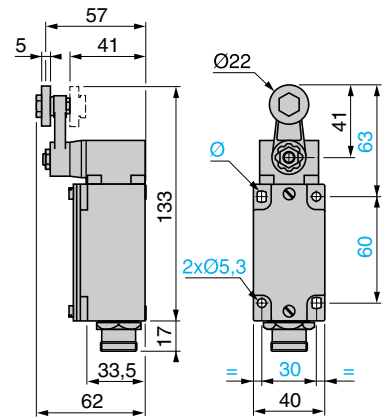

XCKJ10541A

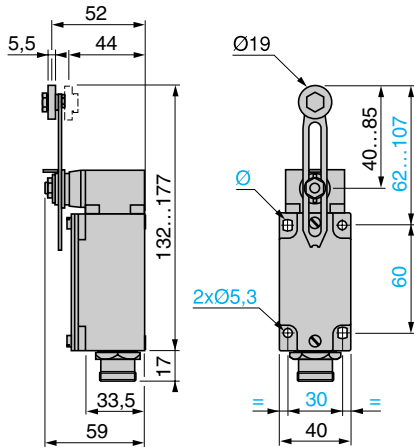

XCKJ10559A

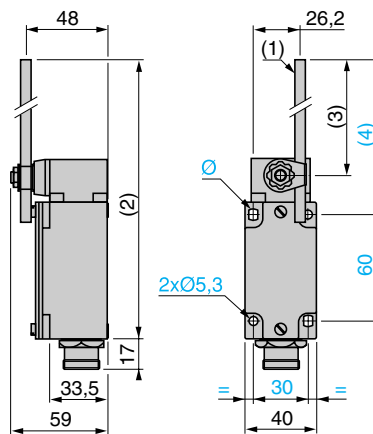

XZCP1771L•

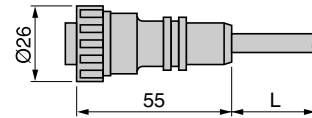

1. Rod Ø 6 mm (0.24 in.), length 200 mm (7.87 in.)
 2. 282 max.
 3. 190 max.
 4. 212 max.
- Ø: 2 elongated holes Ø 5.3 x 7.3
L: cable length: 2, 5, or 10 m (6.6, 16.4, or 32.8 ft)

Connections

Limit switch XCKJ••••A

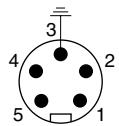

- 1 = 21
- 2 = 22
- 3 = \downarrow
- 4 = 14
- 5 = 13



Pre-wired female connector XZCP1771L•

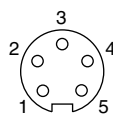

- 1 = black
- 2 = blue
- 3 = yellow/green \downarrow
- 4 = brown
- 5 = white

Limit Switches

Osiswitch® Classic, Metal, Conforming to CENELEC EN 50041

XCKJ—Modular, Fixed Non-plug-in or Plug-in Bodies

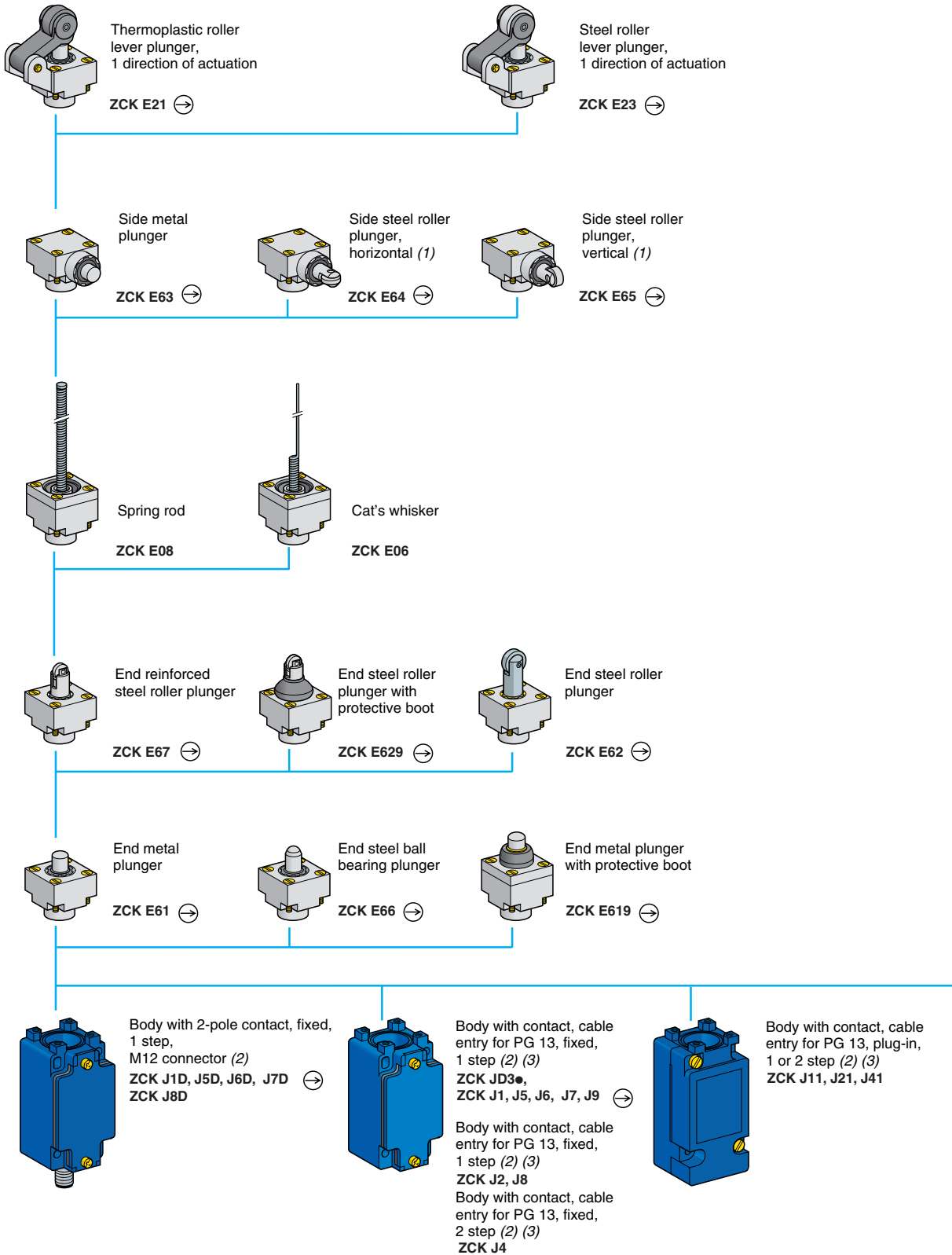

Limit Switches

1. Cannot be used with bodies ZCKJ4 and ZCKJ41.
2. For further details, see page 110.
3. For a cable entry tapped ISO M20 x 1.5, add **H29** to the catalog number. Example: ZCKJ1 becomes **ZCKJ1H29**.
For a cable entry tapped 1/2" NPT, do not add an H code to the catalog number. Example: **ZCKJ1**.

Limit Switches

Osiswitch® Classic, Metal, Conforming to CENELEC EN 50041

XCKJ—Modular, Fixed Non-plug-in or Plug-in Bodies

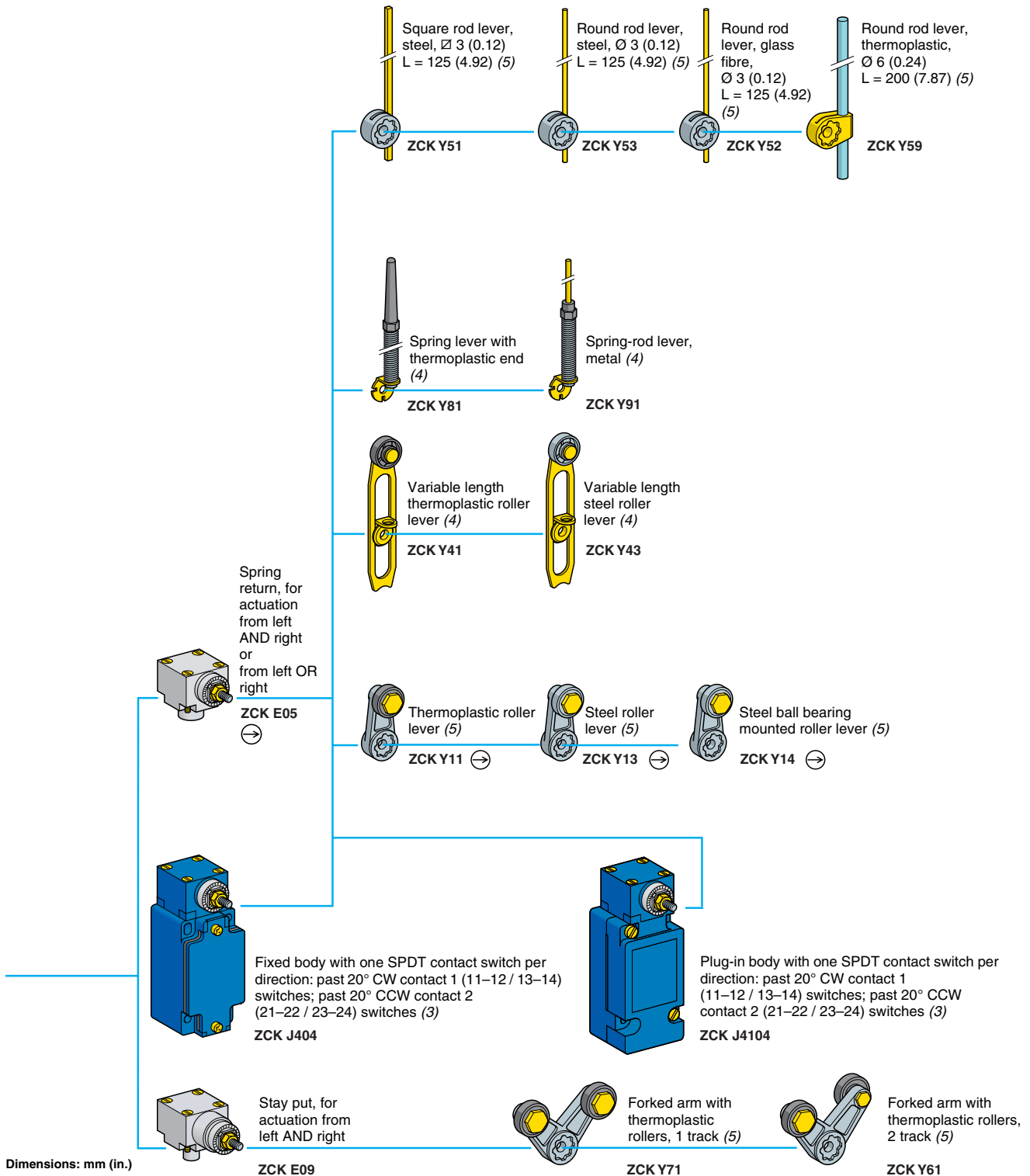

⊙: head assuring positive opening operation, when properly mounted and using a conforming operator.

4. Adjustable throughout 360° in 5° steps, or in 90° steps by reversing the notched washer.
5. Adjustable throughout 360° in 5° steps, or in 45° steps by reversing the lever mounting.

Limit Switches

Osiswitch® Classic, Metal, Conforming to CENELEC EN 50041

XCKJ—Modular, Fixed Non-plug-in or Plug-in Bodies with 1/2" NPT Cable Entry

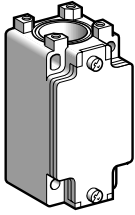

Fixed bodies with 2-pole contact						
Type	With contact block	Function diagram	Positive operation (1)	Cable entry	Catalog number	Weight kg (lb)
1 step	N/C + N/O snap action (XE2S P2151)		⊕	1/2" NPT	ZCKJ1	0.310 (0.683)
				ISO M20 x 1.5	ZCKJ1H29	0.310 (0.683)
	2 C/O simultaneous, snap action (XES P2021)		-	1/2" NPT	ZCKJ2	0.310 (0.683)
				ISO M20 x 1.5	ZCKJ2H29	0.310 (0.683)
	N/C + N/O break before make, slow break (XE2N P2151)		⊕	1/2" NPT	ZCKJ5	0.310 (0.683)
				ISO M20 x 1.5	ZCKJ5H29	0.310 (0.683)
	N/C + N/O make before make, slow break (XE2N P2161)		⊕	1/2" NPT	ZCKJ6	0.310 (0.683)
				ISO M20 x 1.5	ZCKJ6H29	0.310 (0.683)
	N/C + N/C simultaneous, slow break (XE2N P2141)		⊕	1/2" NPT	ZCKJ7	0.310 (0.683)
				ISO M20 x 1.5	ZCKJ7H29	0.310 (0.683)
N/O + N/O simultaneous, slow break (XE2N P2131)		-	1/2" NPT	ZCKJ8	0.310 (0.683)	
			ISO M20 x 1.5	ZCKJ8H29	0.310 (0.683)	
N/C + N/C snap action (XE2S P2141)		⊕	1/2" NPT	ZCKJ9	0.310 (0.683)	
			ISO M20 x 1.5	ZCKJ9H29	0.310 (0.683)	
2 step	2 C/O staggered, snap action (XES P2031)		-	1/2" NPT	ZCKJ4	0.310 (0.683)
				ISO M20 x 1.5	ZCKJ4H29	0.310 (0.683)
Fixed bodies with 3-pole contact						
Type	With contact block	Function diagram	Positive operation (1)	Cable entry	Catalog number	Weight kg (lb)
-	N/C + N/O + N/O snap action (XE3S P2151)		⊕	1/2" NPT	ZCKJD31	0.310 (0.683)
				ISO M20 x 1.5	ZCKJD31H29	0.310 (0.683)
	N/C + N/C + N/O snap action (XE3S P2141)		⊕	1/2" NPT	ZCKJD39	0.310 (0.683)
				ISO M20 x 1.5	ZCKJD39H29	0.310 (0.683)
	N/C + N/C + N/O break before make, slow break (XE3N P2141)		⊕	1/2" NPT	ZCKJD37	0.310 (0.683)
				ISO M20 x 1.5	ZCKJD37H29	0.310 (0.683)
	N/C + N/O + N/O break before make, slow break (XE3N P2151)		⊕	1/2" NPT	ZCKJD35	0.310 (0.683)
				ISO M20 x 1.5	ZCKJD35H29	0.310 (0.683)

1. ⊕: N/C contact with positive opening operation, when properly mounted and using a conforming operator.

Limit Switches

Osiswitch® Classic, Metal, Conforming to CENELEC EN 50041

XCKJ—Modular, Fixed Non-plug-in or Plug-in Bodies with 1/2" NPT Cable Entry

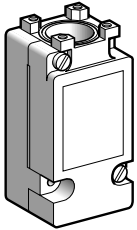

ZCKJ1

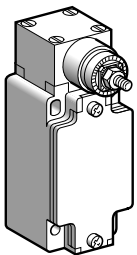

ZCKJ404

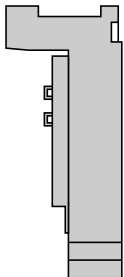

ZCKJ0*

Plug-in bodies with contact						
Type	With contact block	Function diagram	Positive operation (1)	Cable entry	Catalog number	Weight kg (lb)
1 step	Single-pole C/O snap action		—	1/2" NPT	ZCKJ11	0.300 (0.661)
				ISO M20 x 1.5	ZCKJ11H29	0.300 (0.661)
	Double-pole 2 C/O simultaneous, snap action		—	1/2" NPT	ZCKJ21	0.300 (0.661)
				ISO M20 x 1.5	ZCKJ21H29	0.300 (0.661)
2 step	Double-pole 2 C/O staggered, snap action		—	1/2" NPT	ZCKJ41	0.300 (0.661)
				ISO M20 x 1.5	ZCKJ41H29	0.300 (0.661)

Bodies with contact, with rotary head (without operating lever)						
Type	With contact block	Function diagram	Positive operation (1)	Cable entry	Catalog number	Weight kg (lb)
Fixed non-plug-in body						
Neutral position 1 from the left AND 1 from the right	One SPDT contact switch per direction: past 20° CW contact 1 (11–12 / 13–14) switches; past 20° CCW contact 2 (21–22 / 23–24) switches		—	1/2" NPT	ZCKJ404	0.455 (1.003)
				ISO M20 x 1.5	ZCKJ404H29	0.455 (1.003)
Plug-in body						
Neutral position 1 from the left AND 1 from the right	One SPDT contact switch per direction: past 20° CW contact 1 (11–12 / 13–14) switches; past 20° CCW contact 2 (21–22 / 23–24) switches		—	1/2" NPT	ZCKJ4104	0.465 (1.025)
				ISO M20 x 1.5	ZCKJ4104H29	0.465 (1.025)

Plug-in housing switch top only					
Description	For use with	Contacts	Catalog number	Weight kg (lb)	
Single-pole 1 C/O with positive opening operation	ZCKJ11	Silver	ZCKJ01	0.150 (0.331)	
Double-pole 2 C/O simultaneous with positive opening operation	ZCKJ21	Silver	ZCKJ02	0.160 (0.353)	
Double-pole 1 C/O + 1 C/O neutral position	ZCKJ41	Silver	ZCKJ04	0.160 (0.353)	

1. Ⓢ: N/C contact with positive opening operation, when properly mounted and using a conforming operator.

Limit Switches

Osiswitch® Classic, Metal, Conforming to CENELEC EN 50041

XCKJ—Modular, Fixed Non-plug-in or Plug-in Bodies with 1/2" NPT Cable Entry

With Indicator Light Module

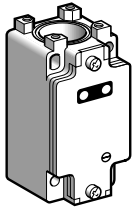

Fixed non-plug-in bodies with 2-pole contact						
Type	With contact block	Function diagram	Positive operation (1)	Cable entry	Catalog number	Weight kg (lb)
With module comprising 1 LED, 24 V$\overline{\text{---}}$						
1 step	N/C + N/O snap action (XE2S P2151)		\oplus	1/2" NPT	ZCKJ120	0.320 (0.705)
	N/C + N/O break before make, slow break (XE2N P2151)		\oplus	1/2" NPT	ZCKJ520	0.320 (0.705)
With module comprising 2 LEDs, 24 V$\overline{\text{---}}$						
1 step	N/C + N/O snap action (XE2S P2151)		\oplus	1/2" NPT	ZCKJ121	0.320 (0.705)
				ISO M20 x 1.5	ZCKJ121H29	0.320 (0.705)
	N/C + N/O break before make, slow break (XE2N P2151)		\oplus	1/2" NPT	ZCKJ521	0.320 (0.705)
				ISO M20 x 1.5	ZCKJ521H29	0.320 (0.705)
With module comprising 2 neon indicator lights, 110/120 V\sim						
1 step	N/C + N/O snap action (XE2S P2151)		\oplus	1/2" NPT	ZCKJ133	0.320 (0.705)
				ISO M20 x 1.5	ZCKJ133H29	0.320 (0.705)
	N/C + N/O break before make, slow break (XE2N P2151)		\oplus	1/2" NPT	ZCKJ533	0.320 (0.705)
				ISO M20 x 1.5	ZCKJ533H29	0.320 (0.705)
With module comprising 2 neon indicator lights, 220/240 V\sim						
1 step	N/C + N/O snap action (XE2S P2151)		\oplus	1/2" NPT	ZCKJ134	0.320 (0.705)
				ISO M20 x 1.5	ZCKJ134H29	0.320 (0.705)
	N/C + N/O break before make, slow break (XE2N P2151)		\oplus	1/2" NPT	ZCKJ534	0.320 (0.705)
				ISO M20 x 1.5	ZCKJ534H29	0.320 (0.705)
Plug-in bodies with single-pole contact						
Type	With contact block	Function diagram	Positive operation (1)	Cable entry	Catalog number	Weight kg (lb)
With module comprising 2 LEDs, 24 V$\overline{\text{---}}$						
1 step	C/O snap action		—	1/2" NPT	ZCKJ1121	0.340 (0.750)
				ISO M20 x 1.5	ZCKJ1121H29	0.340 (0.750)
With module comprising 2 neon indicator lights, 110/120 V\sim						
1 step	C/O snap action		—	1/2" NPT	ZCKJ1133	0.340 (0.750)
				ISO M20 x 1.5	ZCKJ1133H29	0.340 (0.750)
With module comprising 2 neon indicator lights, 220/240 V\sim						
1 step	C/O snap action		—	1/2" NPT	ZCKJ1134	0.340 (0.750)
				ISO M20 x 1.5	ZCKJ1134H29	0.340 (0.750)

1. \oplus : N/C contact with positive opening operation, when properly mounted and using a conforming operator.

Indicator light module characteristics

Type of indicator	1 LED or 2 LEDs	2 neon lights	
Rated insulation voltage	$\overline{\text{---}}$ 50 V, conforming to IEC 60947-1	250 V \sim , conforming to IEC 60947-1	
Current consumption	7 mA per LED	2.5 mA per neon	5 mA per neon
Rated operational voltage	24 V $\overline{\text{---}}$	110/120 V \sim	220/240 V \sim
Voltage limits	20...30 V $\overline{\text{---}}$ (including ripple)	95...130 V \sim	190...260 V \sim
Service life	100 000 hours	20 000 hours	20 000 hours
Reverse polarity protection	Yes	—	

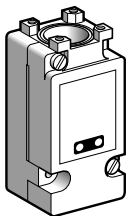

Limit Switches

Osiswitch® Classic, Metal, Conforming to CENELEC EN 50041

XCKJ—Modular, Fixed Non-plug-in Bodies with M12 Connector

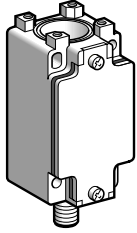

Fixed bodies with 2-pole contact

Type	With contact block	Function diagram	Positive operation (1)	Catalog number	Weight kg (lb)
1 step	N/C + N/O snap action (XE2S P2151)		⊕	ZCKJ1D	0.320 (0.705)
	N/C + N/O break before make, slow break (XE2N P2151)		⊖	ZCKJ5D	0.320 (0.705)
	N/O + N/C make before make, slow break (XE2N P2161)		⊕	ZCKJ6D	0.320 (0.705)
	N/C + N/C simultaneous, slow break (XE2N P2141)		⊖	ZCKJ7D	0.320 (0.705)
	N/O + N/O simultaneous, slow break (XE2N P2131)		—	ZCKJ8D	0.320 (0.705)

1. N/C contact with positive opening operation, when properly mounted and using a conforming operator.

Limit Switches

Osiswitch® Classic, Metal, Conforming to CENELEC EN 50041

XCKJ—Modular, Fixed Non-plug-in or Plug-in Bodies with 1/2" NPT Cable Entry

Low-Temperature Applications (−40 °F / −40 °C)

Body with contacts—For plunger or rotary head

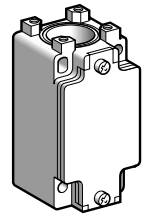

ZCKJ1

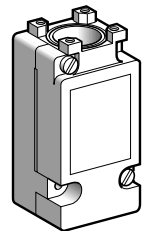

ZCKJ11

Type	Contact block	Function diagram	Positive operation (1)	Cable entry	Catalog number	Weight kg (lb)
Fixed non-plug-in body						
1 step	2-pole 1 N/C + 1 N/O snap action (XE2SP2151)		⊕	1/2" NPT	ZCKJ1	0.310 (0.683)
				ISO M20 x 1.5	ZCKJ1H29	0.310 (0.683)
	Double-pole 2 C/O simultaneous snap action (XESP2021)		—	1/2" NPT	ZCKJ2	0.310 (0.683)
				ISO M20 x 1.5	ZCKJ2H29	0.310 (0.683)
	2-pole 1 N/C + 1 N/O break before make slow break (XE2NP2151)		⊕	1/2" NPT	ZCKJ5	0.310 (0.683)
				ISO M20 x 1.5	ZCKJ5H29	0.310 (0.683)
	2-pole 1 N/O + 1 N/C make before break slow break (XE2NP2161)		⊕	1/2" NPT	ZCKJ6	0.310 (0.683)
				ISO M20 x 1.5	ZCKJ6H29	0.310 (0.683)
	2-pole 1 N/C + 1 N/C simultaneous slow break (XE2NP2141)		⊕	1/2" NPT	ZCKJ7	0.310 (0.683)
				ISO M20 x 1.5	ZCKJ7H29	0.310 (0.683)
2-pole 1 N/O + 1 N/O simultaneous slow break (XE2NP2131)		—	1/2" NPT	ZCKJ8	0.310 (0.683)	
			ISO M20 x 1.5	ZCKJ8H29	0.310 (0.683)	
2-pole 1 N/C + 1 N/C snap action (XE2SP2141)		⊕	1/2" NPT	ZCKJ9	0.310 (0.683)	
			ISO M20 x 1.5	ZCKJ9H29	0.310 (0.683)	
2 step	Double-pole 2 C/O staggered snap action (XESP2031)		—	1/2" NPT	ZCKJ4	0.310 (0.683)
				ISO M20 x 1.5	ZCKJ4H29	0.310 (0.683)
Plug-in body						
1 step	Single-pole 1 C/O snap action		—	1/2" NPT	ZCKJ11	0.300 (0.661)
				ISO M20 x 1.5	ZCKJ11H29	0.300 (0.661)
	Double-pole 2 C/O simultaneous snap action		—	1/2" NPT	ZCKJ21	0.300 (0.661)
				ISO M20 x 1.5	ZCKJ21H29	0.300 (0.661)
2 step	Double-pole 2 C/O staggered snap action		—	1/2" NPT	ZCKJ41	0.300 (0.661)
				ISO M20 x 1.5	ZCKJ41H29	0.300 (0.661)
Body with contacts—With spring return rotary head (without operating lever)						
Fixed non-plug-in body						
Neutral position 1 from the left and 1 from the right	Double-pole 2 C/O staggered snap action		—	1/2" NPT	ZCKJ4046	0.455 (1.003)
				ISO M20 x 1.5	ZCKJ4046H29	0.455 (1.003)
Plug-in body						
Neutral position 1 from the left and 1 from the right	Double-pole 2 C/O staggered snap action		—	1/2" NPT	ZCKJ41046	0.465 (1.025)
				ISO M20 x 1.5	ZCKJ41046H29	0.465 (1.025)

1. ⊕: Operating head able to guarantee positive opening operation, when properly mounted and using a conforming operator. The positive opening feature requires additional travel past the trip point. See the contact function diagrams.

Setup:
page 122

Dimensions:
page 124

Limit Switches

Osiswitch® Classic, Metal, Conforming to CENELEC EN 50041

XCKJ—Modular, Fixed Non-plug-in or Plug-in Bodies with 1/2" NPT Cable Entry

Low-Temperature Applications (−40 °F / −40 °C)

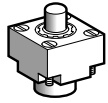

ZCKE616

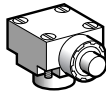

ZCKE636

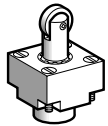

ZCKE626

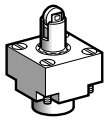

ZCKE676

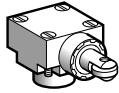

ZCKE646

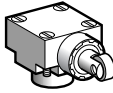

ZCKE656

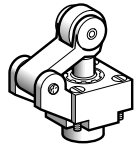

ZCKE216

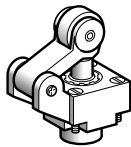

ZCKE236

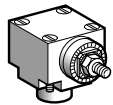

ZCKE056

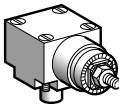

ZCKE096

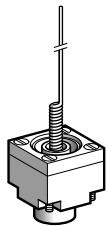

ZCKE066

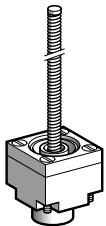

ZCKE086

Plunger heads

Type of operator	Compatible bodies	Max. actuation speed	Positive operation (1)	Catalog number	Weight kg (lb)
For actuation on end					
End plunger metal	ZCKJ•, ZCKJ••	0.5 m/s (1.64 ft/s)	⊖	ZCKE616	0.140 (0.309)
Side plunger metal	ZCKJ•, ZCKJ••, except ZCKJ4 and J41	0.5 m/s (1.64 ft/s)	⊖	ZCKE636	0.200 (0.441)
For actuation by 30° cam					
End roller plunger steel	ZCKJ•, ZCKJ••	1 m/s (3.28 ft/s)	⊖	ZCKE626	0.155 (0.342)
End reinforced roller plunger steel	ZCKJ•, ZCKJ••	1 m/s (3.28 ft/s)	⊖	ZCKE676	0.155 (0.342)
Side roller plunger steel	Horizontal	ZCKJ•, ZCKJ••, except ZCKJ4 and J41	⊖	ZCKE646	0.205 (0.452)
	Vertical	ZCKJ•, ZCKJ••, except ZCKJ4 and J41	⊖	ZCKE656	0.205 (0.452)
Roller lever plunger (1 direction of actuation)	Thermoplastic	ZCKJ•, ZCKJ••	⊖	ZCKE216	0.185 (0.408)
	Steel	ZCKJ•, ZCKJ••	⊖	ZCKE236	0.195 (0.430)

Rotary heads (without operating lever)

Type	Compatible bodies	Max. actuation speed	Positive operation (1)	Catalog number	Weight kg (lb)
Spring return, actuation from left AND right or from left OR right (see page 22)	ZCKJ•, ZCKJ••	1.5 m/s (4.92 ft/s) by 30° cam	⊖	ZCKE056	0.165 (0.364)
Stay put, actuation from left AND right (see page 22)	ZCKJ1, J11 ZCKJ2, J21	1.5 m/s (4.92 ft/s)	—	ZCKE096	0.190 (0.419)

Multi-directional heads

Type of operator	Compatible bodies	Max. actuation speed	Positive operation (1)	Catalog number	Weight kg (lb)
For actuation by any moving part					
"Cat's whisker"	ZCKJ•, ZCKJ••, except ZCKJ4 and ZCKJ41	1 m/s (3.28 ft/s) in any direction	—	ZCKE066	0.115 (0.254)
Spring rod lever	ZCKJ•, ZCKJ••, except ZCKJ4 and ZCKJ41	0.5 m/s (1.64 ft/s) in any direction	—	ZCKE086	0.125 (0.276)

1. ⊖ : Operating head able to guarantee positive opening operation, when properly mounted and using a conforming operator. The positive opening feature requires additional travel past the trip point. See the contact function diagrams.

Limit Switches

Osiswitch® Classic, Metal, Conforming to CENELEC EN 50041

XCKJ—Modular, Fixed Non-plug-in or Plug-in Bodies with 1/2" NPT Cable Entry

Low-Temperature Applications (−40 °F / −40 °C)

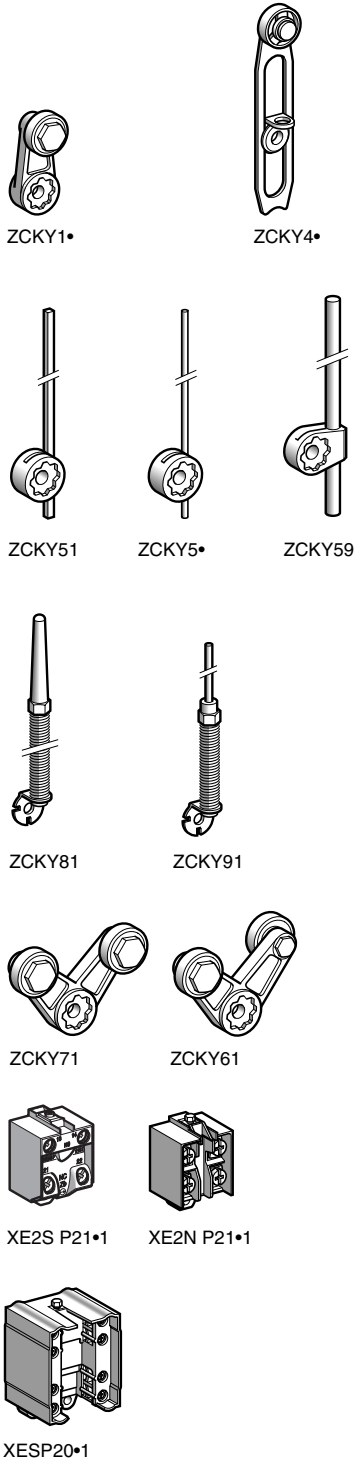

Operating levers for rotary heads					
Description		Positive operation (1)	Catalog number	Weight kg (lb)	
For actuation by 30° cam					
Roller lever (2)	Thermoplastic	⊖	ZCKY11	0.025 (0.055)	
	Steel	⊕	ZCKY13	0.035 (0.077)	
	Steel, ball bearing mounted	⊕	ZCKY14	0.030 (0.066)	
Variable length roller lever (3)	Thermoplastic	—	ZCKY41	0.030 (0.066)	
	Steel	—	ZCKY43	0.040 (0.088)	
For actuation by any moving part					
Square rod (2)	∅ 3 mm (0.12 in.) steel, L = 125 mm (4.92 in.)	—	ZCKY51	0.025 (0.055)	
Round rod (2)	∅ 3 mm (0.12 in.) steel, L = 125 mm (4.92 in.)	—	ZCKY53	0.025 (0.055)	
	∅ 3 mm (0.12 in.) glass fibre, L = 125 mm (4.92 in.)	—	ZCKY52	0.020 (0.044)	
	∅ 6 mm (0.24 in.) thermoplastic, L = 200 mm (7.87 in.)	—	ZCKY59	0.030 (0.066)	
Spring lever (3)		—	ZCKY81	0.020 (0.044)	
Spring metal rod lever (3)		—	ZCKY91	0.025 (0.055)	
For actuation by specific cam (for operation with ZCK-E096 head)					
Forked arm and rollers (2) thermoplastic	1 track	—	ZCKY71	0.035 (0.077)	
	2 track	—	ZCKY61	0.035 (0.077)	
2- or double-pole contact blocks					
Type	Function diagram	For body type	Positive operation (1)	Catalog number	Weight kg (lb)
1 N/C + 1 N/O snap action		ZCKJ1	⊕	XE2SP2151	0.020 (0.044)
1 N/C + 1 N/O break before make slow break		ZCKJ5	⊕	XE2NP2151	0.020 (0.044)
2 C/O simultaneous snap action		ZCKJ2	—	XESP2021	0.045 (0.099)
2 C/O staggered snap action		ZCKJ4	—	XESP2031	0.045 (0.099)
1 N/O + 1 N/C make before break slow break		ZCKJ6	⊕	XE2NP2161	0.020 (0.044)
1 N/C + 1 N/C simultaneous slow break		ZCKJ7	⊕	XE2NP2141	0.020 (0.044)
1 N/O + 1 N/O simultaneous slow break		ZCKJ8	—	XE2NP2131	0.020 (0.044)
1 N/C + 1 N/C snap action		ZCKJ9	⊕	XE2SP2141	0.020 (0.044)

- ⊕ : Operating lever able to guarantee positive opening operation, when properly mounted and using a conforming operator, or N/C contact with positive opening operation. The positive opening feature requires additional travel past the trip point. See the contact function diagrams.
- Adjustable throughout 360° in 5° steps, or in 45° steps by reversing the lever mounting or clamp.
- Adjustable throughout 360° in 5° steps.

Setup:
page 122

Dimensions:
page 124

Limit Switches

Osiswitch® Classic, Metal, Conforming to CENELEC EN 50041

ZCKJ—Modular, Fixed Non-plug-in or Plug-in Bodies with 1/2" NPT Cable Entry

High-Temperature Applications (+248 °F /+120 °C)

Body with contacts—For plunger or rotary head

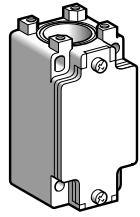

ZCKJ•

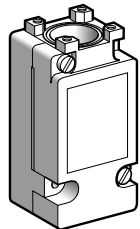

ZCKJ•15

Type	Contact block	Function diagram	Positive operation (1)	Cable entry	Catalog number	Weight kg (lb)
Fixed body						
1 step	2-pole 1 N/C + 1 N/O snap action (XE2SP2151)		⊕	1/2" NPT	ZCKJ1	0.310 (0.683)
				ISO M20 x 1.5	ZCKJ1H29	0.310 (0.683)
	Double-pole 2 C/O simultaneous snap action (XESP20215)		—	1/2" NPT	ZCKJ25	0.310 (0.683)
				ISO M20 x 1.5	ZCKJ25H29	0.310 (0.683)
	2-pole 1 N/C + 1 N/O break before make slow break (XE2NP2151)		⊕	1/2" NPT	ZCKJ5	0.310 (0.683)
				ISO M20 x 1.5	ZCKJ5H29	0.310 (0.683)
	2-pole 1 N/O + 1 N/C make before break slow break (XE2NP2161)		⊕	1/2" NPT	ZCKJ6	0.310 (0.683)
				ISO M20 x 1.5	ZCKJ6H29	0.310 (0.683)
	2-pole 1 N/C + 1 N/C simultaneous slow break (XE2NP2141)		⊕	1/2" NPT	ZCKJ7	0.310 (0.683)
				ISO M20 x 1.5	ZCKJ7H29	0.310 (0.683)
	2-pole 1 N/O + 1 N/O simultaneous slow break (XE2NP2131)		—	1/2" NPT	ZCKJ8	0.310 (0.683)
				ISO M20 x 1.5	ZCKJ8H29	0.310 (0.683)
2-pole 1 N/C + 1 N/C snap action (XE2SP2141)		⊕	1/2" NPT	ZCKJ9	0.310 (0.683)	
			ISO M20 x 1.5	ZCKJ9H29	0.310 (0.683)	
2 step	Double-pole 2 C/O break before make snap action (XESP20315)		—	1/2" NPT	ZCKJ45	0.310 (0.683)
				ISO M20 x 1.5	ZCKJ45H29	0.310 (0.683)
Plug-in body						
1 step	Single-pole 1 C/O snap action		—	1/2" NPT	ZCKJ115	0.300 (0.661)
				ISO M20 x 1.5	ZCKJ115H29	0.300 (0.661)
	Double-pole 2 C/O simultaneous snap action		—	1/2" NPT	ZCKJ215	0.300 (0.661)
				ISO M20 x 1.5	ZCKJ215H29	0.300 (0.661)
2 step	Double-pole 2 C/O break before make snap action		—	1/2" NPT	ZCKJ415	0.300 (0.661)
				ISO M20 x 1.5	ZCKJ415H29	0.300 (0.661)
Body with contacts—With spring return rotary head (without operating lever)						
Fixed body						
2 step 1 from the left AND 1 from the right	Double-pole 2 C/O break before make snap action		—	1/2" NPT	ZCKJ4045	0.455 (1.003)
				ISO M20 x 1.5	ZCKJ4045H29	0.455 (1.003)
Plug-in body						
2 step 1 from the left AND 1 from the right	Double-pole 2 C/O break before make snap action		—	1/2" NPT	ZCKJ41045	0.465 (1.025)
				ISO M20 x 1.5	ZCKJ41045H29	0.465 (1.025)

1. ⊕: Operating head able to guarantee positive opening operation, when properly mounted and using a conforming operator. The positive opening feature requires additional travel past the trip point. See the contact function diagrams.

Setup:
page 122

Dimensions:
page 124

Limit Switches

Osiswitch® Classic, Metal, Conforming to CENELEC EN 50041

XCKJ—Modular, Fixed Non-plug-in or Plug-in Bodies with 1/2" NPT Cable Entry

High-Temperature Applications (+248 °F /+120 °C)

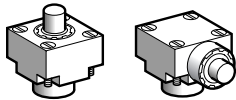

ZCKE615 ZCKE635

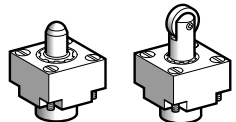

ZCKE665 ZCKE625

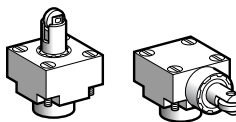

ZCKE675 ZCKE645

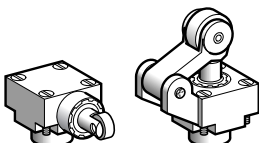

ZCKE655 ZCKE235

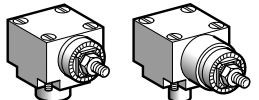

ZCKE055 ZCKE095

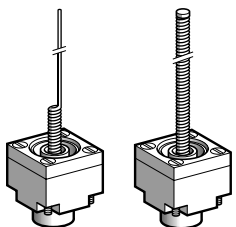

ZCKE065 ZCKE085

Plunger heads						
Type of operator	Compatible bodies		Max. actuation speed	Positive operation (1)	Catalog number	Weight kg (lb)
For actuation on end						
End plunger	Metal	ZCKJ1, J2, J4, ZCKJ115, J215, J415, ZCKJ5, J6, J7, J8, J9	0.5 m/s (1.64 ft/s)	⊖	ZCKE615	0.140 (0.309)
Side plunger	Metal	ZCKJ1, J2, ZCKJ115, J215, ZCKJ5, J6, J7, J8, J9	0.5 m/s (1.64 ft/s)	⊖	ZCKE635	0.200 (0.441)
For actuation by 30° cam						
End ball bearing plunger	Steel	ZCKJ1, J2, J4, ZCKJ115, J215, J415, ZCKJ5, J6, J7, J8, J9	0.1 m/s (0.33 ft/s)	⊖	ZCKE665	0.150 (0.331)
End roller plunger	Steel	ZCKJ1, J2, J4, ZCKJ115, J215, J415, ZCKJ5, J6, J7, J8, J9	1 m/s (3.28 ft/s)	⊖	ZCKE625	0.155 (0.342)
End reinforced roller plunger	Steel	ZCKJ1, J2, J4, ZCKJ115, J215, J415, ZCKJ5, J6, J7, J8, J9	1 m/s (3.28 ft/s)	⊖	ZCKE675	0.155 (0.342)
Side roller plunger	Steel Horizontal	ZCKJ1, J2, ZCKJ115, J215, ZCKJ5, J6, J7, J8, J9	0.6 m/s (1.97 ft/s)	⊖	ZCKE645	0.205 (0.452)
	Steel Vertical	ZCKJ1, J2, ZCKJ115, J215, ZCKJ5, J6, J7, J8, J9	0.6 m/s (1.97 ft/s)	⊖	ZCKE655	0.205 (0.452)
Roller lever plunger (1 direction of actuation)	Steel	ZCKJ1, J2, J4, ZCKJ115, J215, J415, ZCKJ5, J6, J7, J8, J9	1.5 m/s (4.92 ft/s)	⊖	ZCKE235	0.195 (0.430)
	Thermoplastic	ZCKJ1, J2, J4, ZCKJ115, J215, J415, ZCKJ5, J6, J7, J8, J9	1.5 m/s (4.92 ft/s)	⊖	ZCKE215	0.185 (0.408)
Rotary heads (without operating lever)						
Type	Compatible bodies		Max. actuation speed	Positive operation (1)	Catalog number	Weight kg (lb)
Spring return, actuation from left AND right or from left OR right (see page 22)	ZCKJ1, J2, J4, ZCKJ115, J215, ZCKJ415, ZCKJ5, J6, J7, J8, J9		1.5 m/s (4.92 ft/s) by 30° cam	⊖	ZCKE055	0.165 (0.364)
Stay put, actuation from left AND right (see page 22)	ZCKJ1, J2, ZCKJ115, J215		0.5 m/s (1.64 ft/s)	—	ZCKE095	0.190 (0.419)
Multi-directional heads						
Type of operator	Compatible bodies		Max. actuation speed	Positive operation (1)	Catalog number	Weight kg (lb)
For actuation by any moving part						
"Cat's whisker"	ZCKJ1, J2, ZCKJ115, J215, ZCKJ5, J6, J7, J8, J9		1 m/s (3.28 ft/s) in any direction	—	ZCKE065	0.115 (0.254)
Spring rod lever	ZCKJ1, J2, ZCKJ115, J215, ZCKJ5, J6, J7, J8, J9		0.5 m/s (1.64 ft/s) in any direction	—	ZCKE085	0.125 (0.276)

1. ⊖ : Operating head able to guarantee positive opening operation, when properly mounted and using a conforming operator. The positive opening feature requires additional travel past the trip point. See the contact function diagrams.

Limit Switches

Osiswitch® Classic, Metal, Conforming to CENELEC EN 50041

XCKJ—Modular, Fixed Non-plug-in or Plug-in Bodies with 1/2" NPT Cable Entry

High-Temperature Applications (+248 °F /+120 °C)

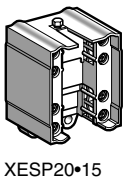
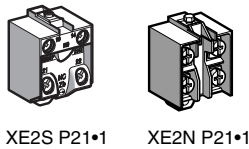
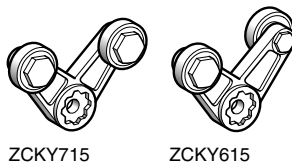
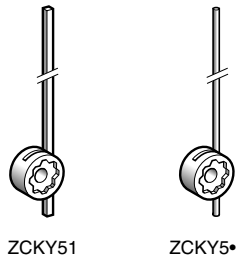
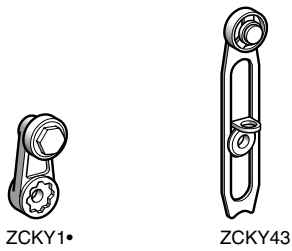

Operating levers for rotary heads

Description	Positive operation (1)	Catalog number	Weight kg (lb)
For actuation by 30° cam			
Roller lever (2)	Thermoplastic	⊖	ZCKY115 0.025 (0.055)
	Steel	⊖	ZCKY13 0.035 (0.077)
	Steel, ball bearing mounted	⊖	ZCKY14 0.030 (0.066)
Variable length roller lever (3)	Thermoplastic	—	ZCKY415 0.030 (0.066)
	Steel	—	ZCKY43 0.040 (0.088)

For actuation by any moving part

Square rod (2)	⊘ 3 mm (0.12 in.) Steel, L = 125 mm (4.92 in.)	—	ZCKY51 0.025 (0.055)
Round rod (2)	⊘ 3 mm (0.12 in.) steel, L = 125 mm (4.92 in.)	—	ZCKY53 0.025 (0.055)
	⊘ 3 mm (0.12 in.) glass fibre, L = 125 mm (4.92 in.)	—	ZCKY52 0.020 (0.044)

For actuation by specific cam (for operation with ZCK-E095 head only)

Forked arm and rollers (2) thermoplastic	1 track	—	ZCKY715 0.035 (0.077)
	2 track	—	ZCKY615 0.035 (0.077)

2- or double-pole contact blocks

Type of operator	Function diagram	For body type	Positive operation (1)	Catalog number	Weight kg (lb)
1 N/C + 1 N/O snap action		ZCKJ1	⊖	XE2SP2151	0.020 (0.044)
1 N/C + 1 N/O break before make slow break		ZCKJ5	⊖	XE2NP2151	0.020 (0.044)
2 C/O simultaneous snap action		ZCKJ25	—	XESP20215	0.045 (0.099)
2 C/O staggered snap action		ZCKJ45	—	XESP20315	0.045 (0.099)
1 N/O + 1 N/C make before break slow break		ZCKJ6	⊖	XE2NP2161	0.020 (0.044)
1 N/C + 1 N/C simultaneous slow break		ZCKJ7	⊖	XE2NP2141	0.020 (0.044)
1 N/O + 1 N/O simultaneous slow break		ZCKJ8	—	XE2NP2131	0.020 (0.044)
1 N/C + 1 N/C snap action		ZCKJ9	⊖	XE2SP2141	0.020 (0.044)

- ⊖ : Operating head able to guarantee positive opening operation, when properly mounted and using a conforming operator. The positive opening feature requires additional travel past the trip point. See the contact function diagrams.
- Adjustable throughout 360° in 5° steps, or in 45° steps by reversing the lever mounting or clamp.
- Adjustable throughout 360° in 5° steps.

Limit Switches

Osiswitch® Classic, Metal, Conforming to CENELEC EN 50041

XCKJ—Modular, Fixed Non-plug-in or Plug-in Bodies—Components

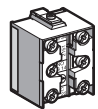
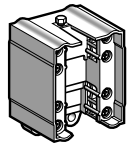
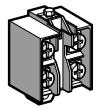

Contact blocks					
Type of contact	Function diagram	For bodies	Positive operation (1)	Catalog number	Weight kg (lb)
2-pole contact					
N/C + N/O snap action		ZCKJ1 ZCKJ1D	⊕	XE2S P2151	0.020 (0.044)
N/C + N/O break before make, slow break		ZCKJ5 ZCKJ5D	⊕	XE2N P2151	0.020 (0.044)
2 C/O simultaneous, snap action		ZCKJ2	—	XES P2021	0.045 (0.099)
2 C/O staggered, snap action		ZCKJ4	—	XES P2031	0.045 (0.099)
N/O + N/C make before break, slow break		ZCKJ6 ZCKJ6D	⊕	XE2N P2161	0.020 (0.044)
N/C + N/C simultaneous, slow break		ZCKJ7 ZCKJ7D	⊕	XE2N P2141	0.020 (0.044)
N/O + N/O simultaneous, slow break		ZCKJ8 ZCKJ8D	—	XE2N P2131	0.020 (0.044)
N/C + N/C snap action		ZCKJ9	⊕	XE2S P2141	0.020 (0.044)
3-pole contact					
N/C + N/O + N/O snap action		ZCKJD31	⊕	XE3S P2151	0.035 (0.077)
N/C + N/C + N/O snap action		ZCKJD39	⊕	XE3S P2141	0.035 (0.077)
N/C + N/C + N/O break before make, slow break		ZCKJD37	⊕	XE3N P2141	0.035 (0.077)
N/C + N/O + N/O break before make, slow break		ZCKJD35	⊕	XE3N P2151	0.035 (0.077)

1. ⊕: N/C contact with positive opening operation, when properly mounted and using a conforming operator.

Limit Switches

Osiswitch® Classic, Metal, Conforming to CENELEC EN 50041

XCKJ—Modular, Fixed Non-plug-in or Plug-in Bodies—Components

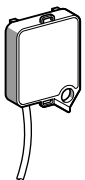
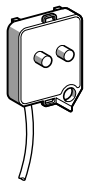
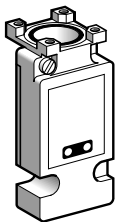
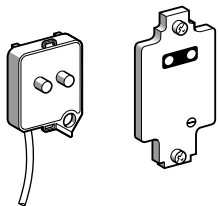

Covers + indicator light module				
For use with	Number and type of indicators	Voltage	Catalog number	Weight kg (lb)
Fixed non-plug-in body	1 LED	24 V \cdots	ZCK Z020	0.060 (0.132)
	2 LEDs	24 V \cdots	ZCK Z021	0.060 (0.132)
	2 neon lights	110/120 V \sim	ZCK Z033	0.060 (0.132)
		220/240 V \sim	ZCK Z034	0.060 (0.132)
Plug-in switch-top body with pilot lights	2 LEDs	24 V \cdots	ZCKJ0121	0.200 (0.441)
	2 neon lights	110/120 V \sim	ZCKJ0133	0.200 (0.441)
		220/240 V \sim	ZCKJ0134	0.200 (0.441)
	Indicator light modules			
For use with	Number and type of indicators	Voltage	Catalog number	Weight kg (lb)
Fixed non-plug-in body	1 LED	24 V \cdots	ZCKJ902	0.030 (0.066)
	2 LEDs	24 V \cdots	ZCKJ906	0.030 (0.066)
	2 neon lights	110/120 V \sim	ZCKJ903	0.030 (0.066)
		220/240 V \sim	ZCKJ904	0.030 (0.066)
Module with resistor for machine diagnostics				
For use with	Resistor value		Catalog number	Weight kg (lb)
Fixed non-plug-in body (XCKJ1 and ZCKJ1 only)	15 k Ω , 1/4 W		ZCKJ82A	0.030 (0.066)
Other versions	Covers + indicator light module for other supply voltages. Please consult your local sales office.			

Limit Switches

Osiswitch® Classic, Metal, Conforming to CENELEC EN 50041

XCKJ—Modular, Fixed Non-plug-in or Plug-in Bodies—Components

Function diagrams (positive operation assured only if the associated sub-assemblies are ⊕)

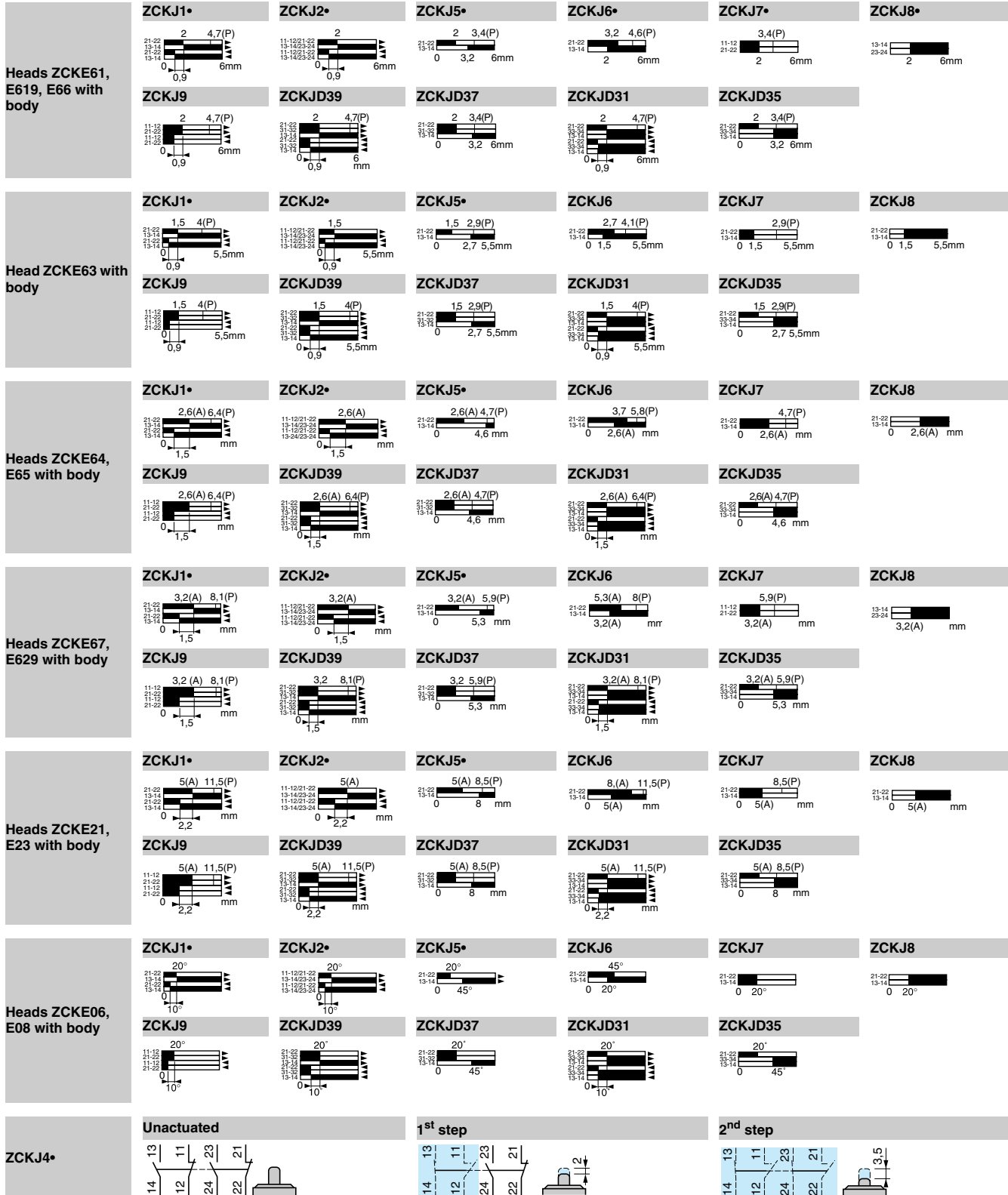

Contact operation

■ contact closed
□ contact open

(A) = cam displacement
(P) = positive opening point

Limit Switches

Osiswitch® Classic, Metal, Conforming to CENELEC EN 50041 XCKJ—Modular, Fixed Non-plug-in or Plug-in Bodies—Components

Function diagrams (positive operation assured only if the associated sub-assemblies are ⊕)

Head ZCKE05 with body

ZCKJ1•

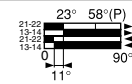

ZCKJ2•



ZCKJ5•

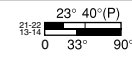

ZCKJ6

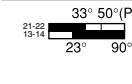

ZCKJ7

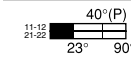

ZCKJ8

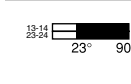

ZCKJ9

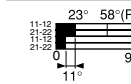

ZCKJD39

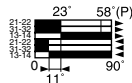

ZCKJD37

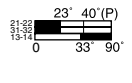

ZCKJD39

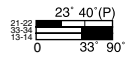

ZCKJD31

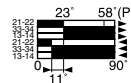

ZCKJ4•

Unactuated

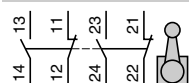

1st step, actuated from left or right

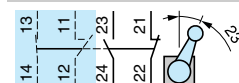

2nd step, actuated from left or right

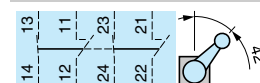

Head ZCKE09 with body

ZCKJ1•

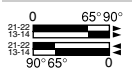

ZCKJ2•

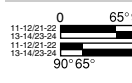

ZCKJD31

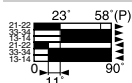

ZCKJD39

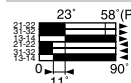

ZCKJ404, J4104 (body with head)

Unactuated

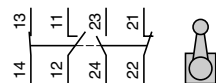

Actuated from left

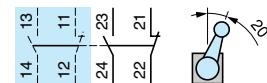

Actuated from right

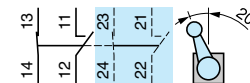

Contact operation

■ contact closed
□ contact open

(P) = positive opening point

Wiring diagrams

Indicator light modules

1 LED, 24 V $\overline{\text{DC}}$

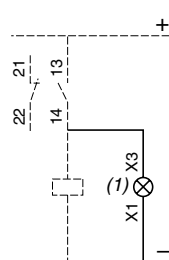

2 LEDs, 24 V $\overline{\text{DC}}$

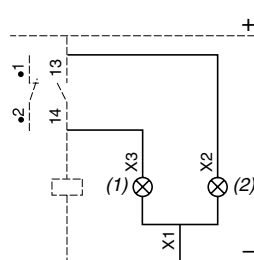

2 neon lights, 110/120 or 220/240 V \sim

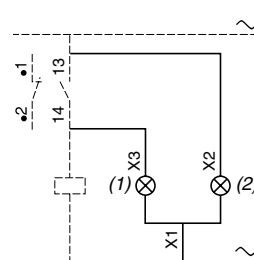

Module with resistor

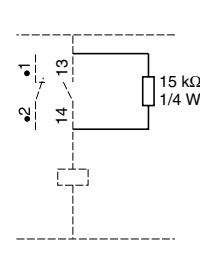

1. Orange indicator
2. Green indicator

ZCKJ•D

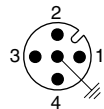

- 1-2= N/C
- 3-4= N/O
- 5= \perp
- 4 A / 24 V max.



Limit Switches

Osiswitch® Classic, Metal, Conforming to CENELEC EN 50041

XCKJ—Modular, Fixed Non-plug-in or Plug-in Bodies—Components

Bodies

Non-plug-in

ZCKJ1, J2, J5, J4, J2•, J3•, J6, J7, J8, J9
ZCKJ1H29, J2H29, J5H29, J4H29, J2•H29, J3•H29,
J6H29, J7H29, J8H29, J9H29

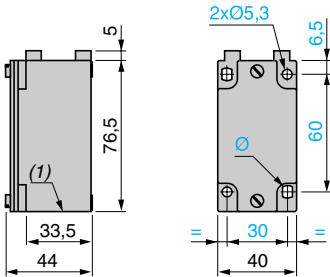

Plug-in

ZCKJ11, J21, J41, J11••
ZCKJ11H29, J21H29, J41H29, J11••H29

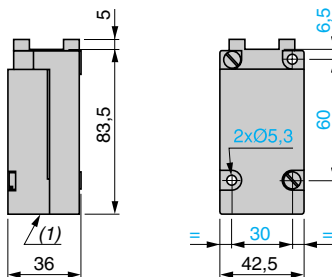

Non-plug-in

ZCKJ1D, J5D, J6D, J7D, J8D

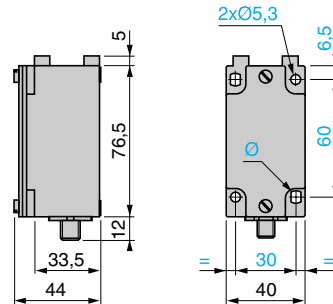

Bodies with rotary head mounted

Non-plug-in

ZCKJ404, ZCKJ404H29

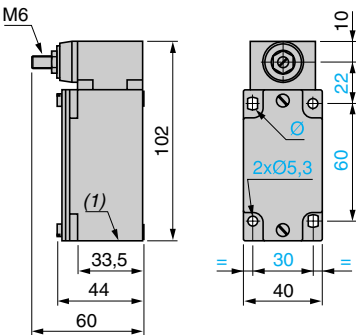

Plug-in

ZCKJ4104, ZCKJ4104H29

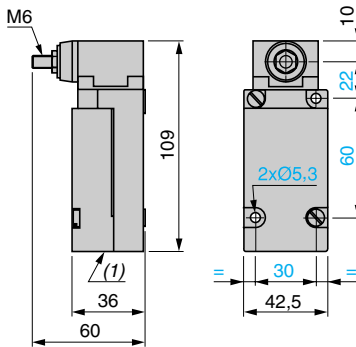

Plunger heads

ZCKE61

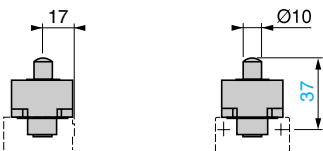

ZCKE619

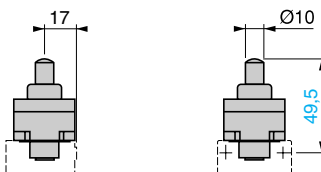

ZCKE63

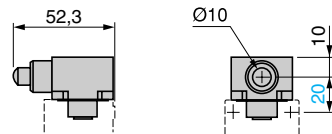

ZCKE64

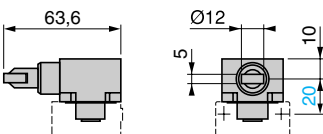

ZCKE65

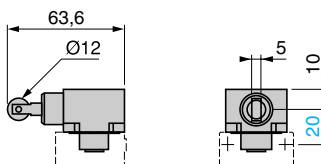

ZCKE66

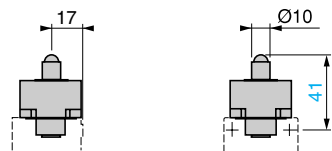

ZCKE62, ZCKE67

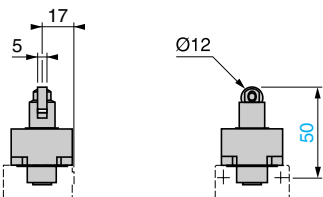

ZCKE629

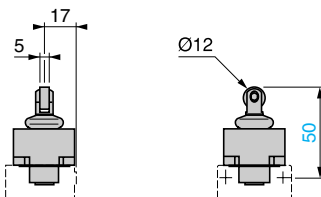

ZCKE21, E23

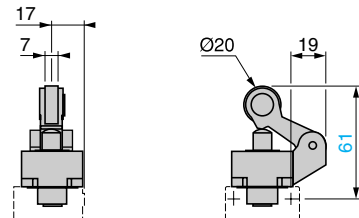

1: 1 tapped entry for 1/2" NPT.
Ø: 2 elongated holes Ø 5.3 x 7.3.

Limit Switches

Osiswitch® Classic, Metal, Conforming to CENELEC EN 50041 XCKJ—Modular, Fixed Non-plug-in or Plug-in Bodies—Components

Rotary head ZCKE05 with operating lever ZCKY11, Y13, Y14

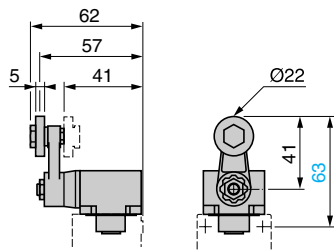

ZCKY41, Y43

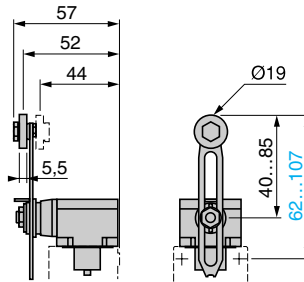

ZCKY51, Y52, Y53, Y59

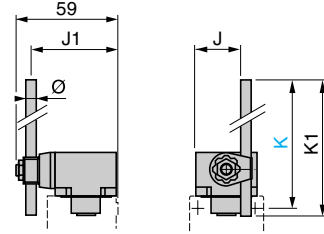

ZCKY81

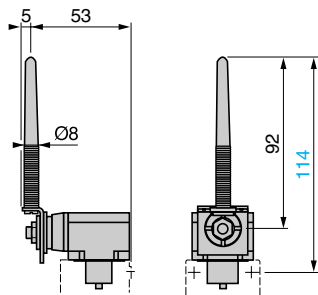

ZCKY91

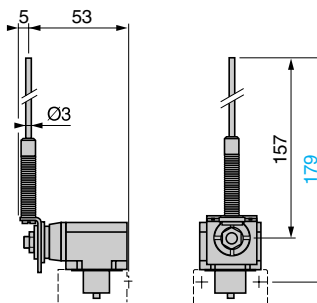

	J	J1	K max	K1	Ø
ZCKY51	20	49	137	123	Ø 3
ZCKY52	20	49	137	125	Ø 3
ZCKY53	20	49	137	125	Ø 3
ZCKY59	26.2	48	212	200	Ø 6

Rotary head ZCKE09 with operating lever ZCKY61

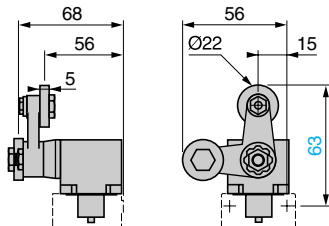

ZCKY71

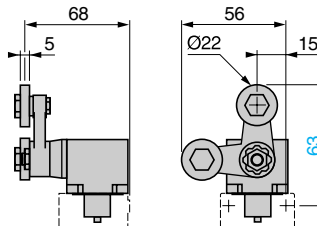

Multi-directional heads

ZCKE06

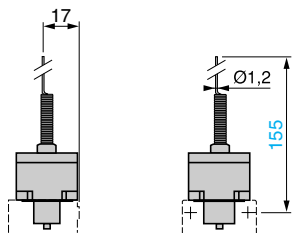

ZCKE08

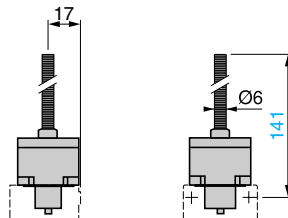

NOTE: Operating lever spindle threaded M6.

Limit Switches

Osiswitch® Classic, Plastic, Conforming to CENELEC EN 50041

XCKS—Double Insulated

■ XCKS
fixed, non-plug-in body with 1 cable entry

□ With head for linear movement (plunger) operators

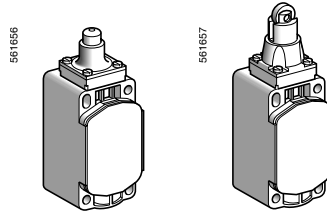

Page 128

□ With head for rotary movement (lever) operators

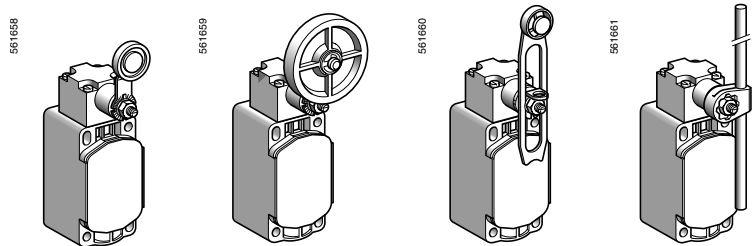

Page 128

Environmental characteristics

Conforming to standards	Products	IEC 60947-5-1, EN 60947-5-1, UL 508, CSA C22-2 n° 14
	Machine assemblies	IEC 60204-1, EN 60204-1
Approvals		UL, CSA, CCC
Protective treatment	Version	Standard "TC" and "TH"
Ambient air temperature	For operation	- 25...+70 °C (-13...+158 °F)
	For storage	- 40...+70 °C (-40...+158 °F)
Vibration resistance	Conforming to IEC 60068-2-6	25 gn (10...500 Hz)
Shock resistance	Conforming to IEC 60068-2-27	50 gn (11 ms)
Electric shock protection		Class II conforming to IEC 61140 and NF C 20-030
Degree of protection		IP 65 conforming to IEC 60529; IK 03 conforming to EN 50102
Repeat accuracy		0.05 mm on the tripping points, with 1 million operating cycles for head with end plunger
Cable entry	Depending on model	Tapped entry for PG 13 conduit thread, or tapped ISO M20 x 1.5, 1/2" NPT with adapter
Materials		Body and heads: plastic

Limit Switches

Osiswitch® Classic, Plastic, Conforming to CENELEC EN 50041

XCKS—Double Insulated

Contact block characteristics		
Rated operational characteristics	XE2•P	~ AC-15; A300 (Ue = 240 V, Ie = 3 A); Ithe = 10 A --- DC-13; Q300 (Ue = 250 V, Ie = 0,27 A), conforming to IEC 60947-5-1 Appendix A, EN 60947-5-1
	XE3•P	~ AC-15; B300 (Ue = 240 V, Ie = 1,5 A); Ithe = 6 A --- DC-13; R300 (Ue = 250 V, Ie = 0,1 A), conforming to IEC 60947-5-1 Appendix A, EN 60947-5-1
Rated insulation voltage	XE2•P	Ui = 500 V degree of pollution 3 conforming to IEC 60947-1 Ui = 300 V conforming to UL 508, CSA C22-2 n° 14
	XE3•P	Ui = 400 V degree of pollution 3 conforming to IEC 60947-1 Ui = 300 V conforming to UL 508, CSA C22-2 n° 14
Rated impulse withstand voltage	XE2•P	U imp = 6 kV conforming to IEC 60947-1, IEC 60664
	XE3•P	U imp = 4 kV conforming to IEC 60947-1, IEC 60664
Positive operation (depending on model)		N/C contacts with positive opening operation conforming to IEC 60947-5-1 Appendix K, EN 60947-5-1
Resistance across terminals		≤ 25 mΩ conforming to IEC 60255-7 category 3
Short-circuit protection	XE2•P	10 A cartridge fuse type gG (gl)
	XE3•P	6 A cartridge fuse type gG (gl)
Cabling (screw and captive cable clamp terminals)	XE2SP21•1	Clamping capacity, min.: 1 x 0.34 mm ² , max.: 2 x 1.5 mm ²
	XE2NP21•1	Clamping capacity, min.: 1 x 0.5 mm ² , max.: 2 x 2.5 mm ²
	XESP3021	Clamping capacity, min.: 1 x 0.75 mm ² , max.: 2 x 1.5 mm ²
	XE3NP and XE3SP	Clamping capacity, min.: 1 x 0.34 mm ² , max.: 1 x 1 mm ² or 2 x 0.75 mm ²
Minimum actuation speed		XE2SP21•1, XESP3021 and XE3SP: 0.01 m/minute (0.03 ft/minute) XE2NP21•1 and XE3NP: 6 m/minute (19.68 ft/minute)
Electrical durability		<ul style="list-style-type: none"> • Conforming to IEC 60947-5-1 Appendix C • Utilization categories AC-15 and DC-13 • Maximum operating rate: 3600 operating cycles per hour • Load factor: 0.5

XE2SP21•1, XE2SP2141

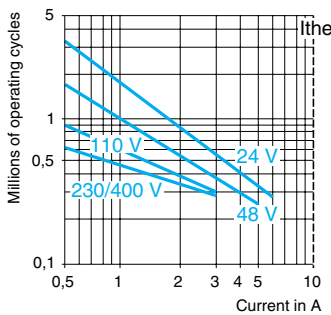

XE2NP21•1

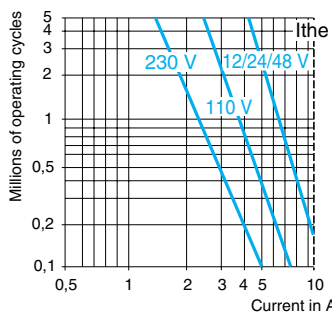

XESP3021

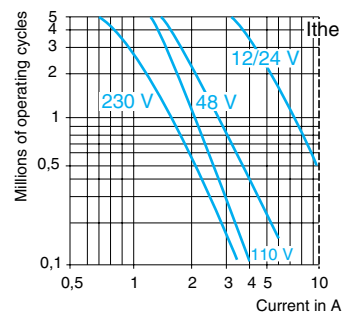

d.c. supply ---

Power switched in W for 5 million operating cycles.

Voltage	V	24	48	120
mm	W	10	7	4

Power switched in W for 5 million operating cycles.

Voltage	V	24	48	120
mm	W	13	9	7

Power switched in W for 5 million operating cycles.

Voltage	V	24	48	120
mm	W	10	7	4

For XE2SP•151 on ~ or ---, N/C and N/O contacts simultaneously loaded to the values shown with reverse polarity.

XE3SP••••

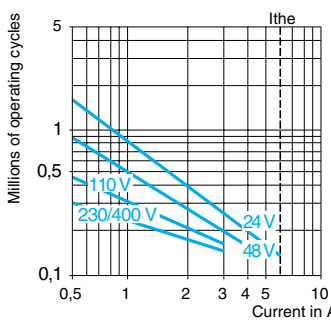

XE3NP••••

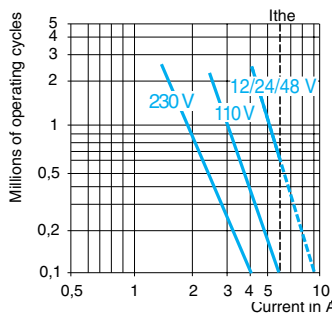

d.c. supply ---

Power switched in W for 5 million operating cycles.

Voltage	V	24	48	120
mm	W	3	2	1











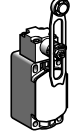







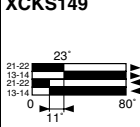
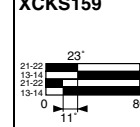

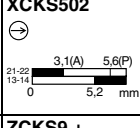

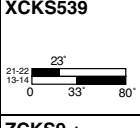

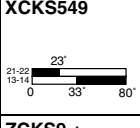
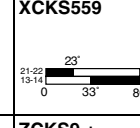

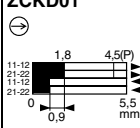
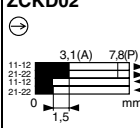
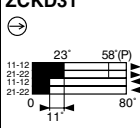
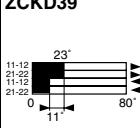
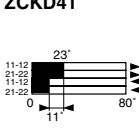
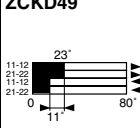
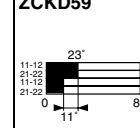

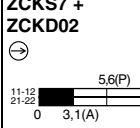
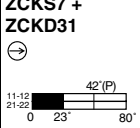
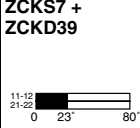
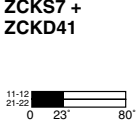
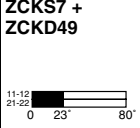
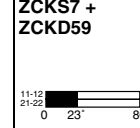

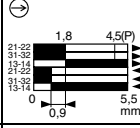
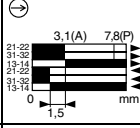
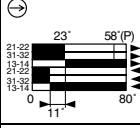
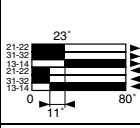
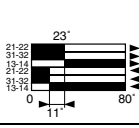
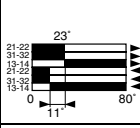
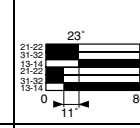

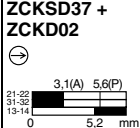
Power switched in W for 5 million operating cycles.

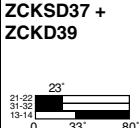
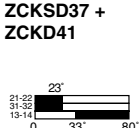
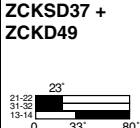
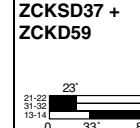
Voltage	V	24	48	120
mm	W	4	3	2

Limit Switches

Osiswitch® Classic, Plastic, Conforming to CENELEC EN 50041

XCKS—Double Insulated, Complete Switches with 1/2" NPT Adapter Included

Type of head	Plunger (mounting by the body)		Rotary (mounting by the body)				
	Form B (1)	Form C (1)	Form A (1)				Form D (1)
Type of operator	Metal end plunger	Steel roller plunger	Thermoplastic roller lever (4)	Elastomer roller lever, Ø 50 mm (1.97 in.) (4)	Variable length thermoplastic roller lever (4)	Variable length elastomer roller lever, Ø 50 mm (1.97 in.) (4)	Round thermoplastic rod lever, Ø 6 mm (0.24 in.) (5) (6)
Catalog numbers (2) (3)	XCKS101	XCKS102	XCKS131	XCKS139	XCKS141	XCKS149	XCKS159
 2-pole N/C + N/O snap action (XE2S P2151)							
 2-pole N/C + N/O break before make, slow break (XE2N P2151)							
 2-pole N/C + N/C snap action (XE2S P2141)							
 2-pole N/C + N/C simultaneous, slow break (XE2N P2141)							
 3-pole N/C + N/C + N/O snap action (XE3S P2141)							
 3-pole N/C + N/C + N/O break before make, slow break (XE3N P2141)							
Weight, kg (lb)	0.095 (0.209)	0.105 (0.231)	0.145 (0.320)	0.150 (0.331)	0.155 (0.342)	0.155 (0.342)	0.150 (0.331)
Contact operation	 contact closed  contact open		(A) = cam displacement (P) = positive opening point	 N/C contact with positive opening operation, when properly mounted and using a conforming operator			
Characteristics							
Switch actuation	On end	By 30° cam					By any moving part
Type of actuation							
Maximum actuation speed	0.5 m/s (1.64 ft/s)		1.5 m/s (4.92 ft/s)				1 m/s (3.28 ft/s)
Minimum force or torque	For tripping For positive opening	15 N (3.37 lb) 45 N (10.12 lb)	12 N (2.70 lb) 36 N (8.09 lb)	0.15 N•m (1.33 lb-in) 0.3 N•m (2.66 lb-in)	—		
Cable entry (3)	1 entry tapped M20 x 1.5 mm for ISO cable entry, clamping capacity 7 to 13 mm (0.28 to 0.51 in.)						

- Form conforming to EN 50041. See page 23.
- Switches with gold contacts or eyelet type connections: please consult your local sales office.
- To convert PG 13 to 1/2" NPT, use adapter DE9RA1212. For ISO M20 x 1.5, add H29 to the end of the catalog number. Example: XCKS101 becomes XCKS101H29.
- Adjustable throughout 360° in 5° steps, or in 90° steps by reversing the notched washer.
- Adjustable throughout 360° in 5° steps, or in 45° steps by reversing the lever mounting.
- Value taken with actuation by moving part at 100 mm (3.94 in.) from the mounting.

Limit Switches

Osiswitch® Classic, Plastic, Conforming to CENELEC EN 50041

XCKS—Double Insulated, Complete Switches with 1/2" NPT Adapter Included

XCKS-01
ZCKS• + ZCKD01

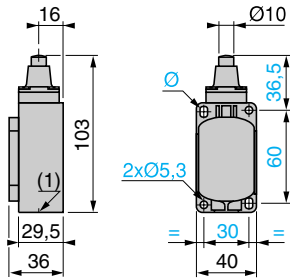

XCKS-02
ZCKS• + ZCKD02

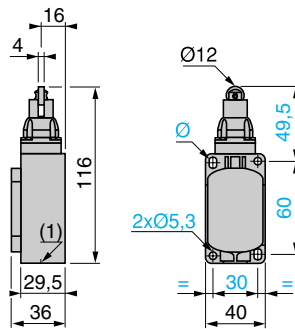

XCKS-31
ZCKS• + ZCKD31

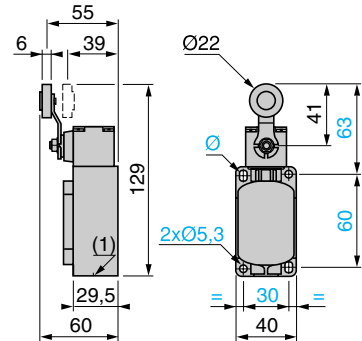

XCKS-39
ZCKS• + ZCKD39

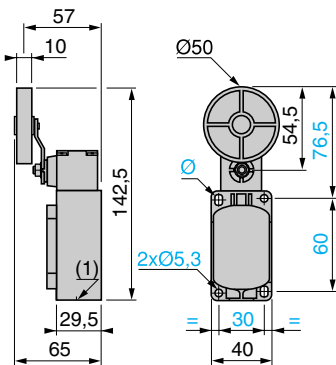

XCKS-41
ZCKS• + ZCKD41

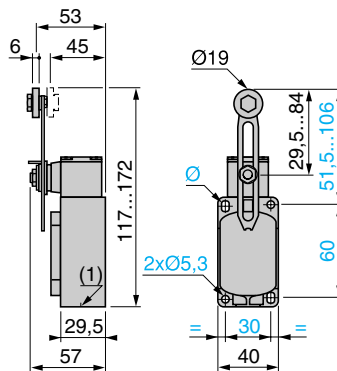

XCKS-49
ZCKS• + ZCKD49

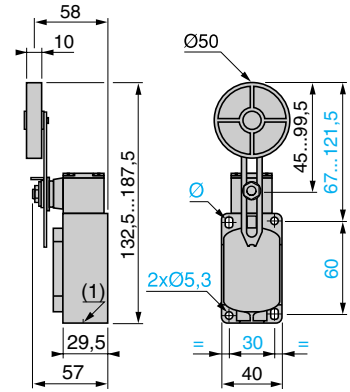

XCKS-59
ZCKS• + ZCKD59

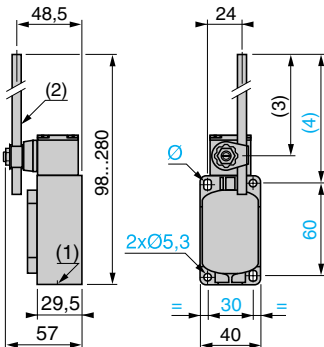

1. 1 tapped entry for PG 13 conduit thread (convertible to 1/2" NPT using adapter DE9RA1212, included); or
1 tapped entry for ISO M20 x 1.5 conduit thread (with suffix H29 added to the catalog number).
 2. Rod Ø 6 mm (0.24 in.), length 200 mm (7.87 in.).
 3. 190 max.
 4. 212 max.
- Ø: 2 elongated holes Ø 5.3 x 7.3.

Limit Switches

Osiswitch® Classic, Plastic, Conforming to CENELEC EN 50041

XCKS—Double Insulated, Modular

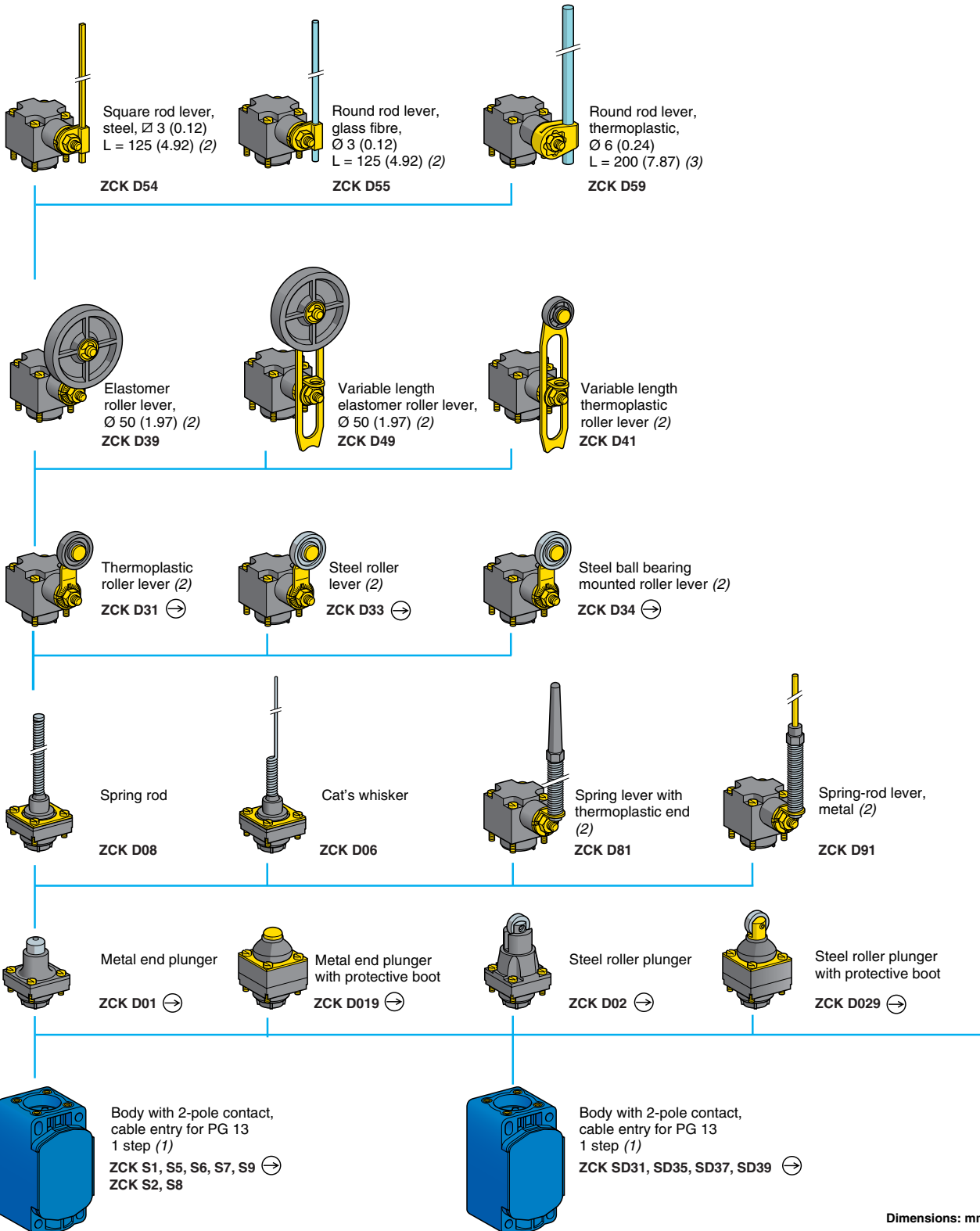

Dimensions: mm (in.)

1. For further details, see page 132. For a cable entry tapped ISO M20 x 1.5, add **H29** to the catalog number. Example: ZCKS1 becomes **ZCKS1H29**. To convert PG 13 to 1/2" NPT, use adapter DE9RA1212. See page 135 for dimensional drawing.
2. Adjustable throughout 360° in 5° steps, or in 90° steps by reversing the notched washer.
3. Adjustable throughout 360° in 5° steps, or in 45° steps by reversing the lever mounting.

Limit Switches

Osiswitch® Classic, Plastic, Conforming to CENELEC EN 50041

XCKS—Double Insulated, Modular

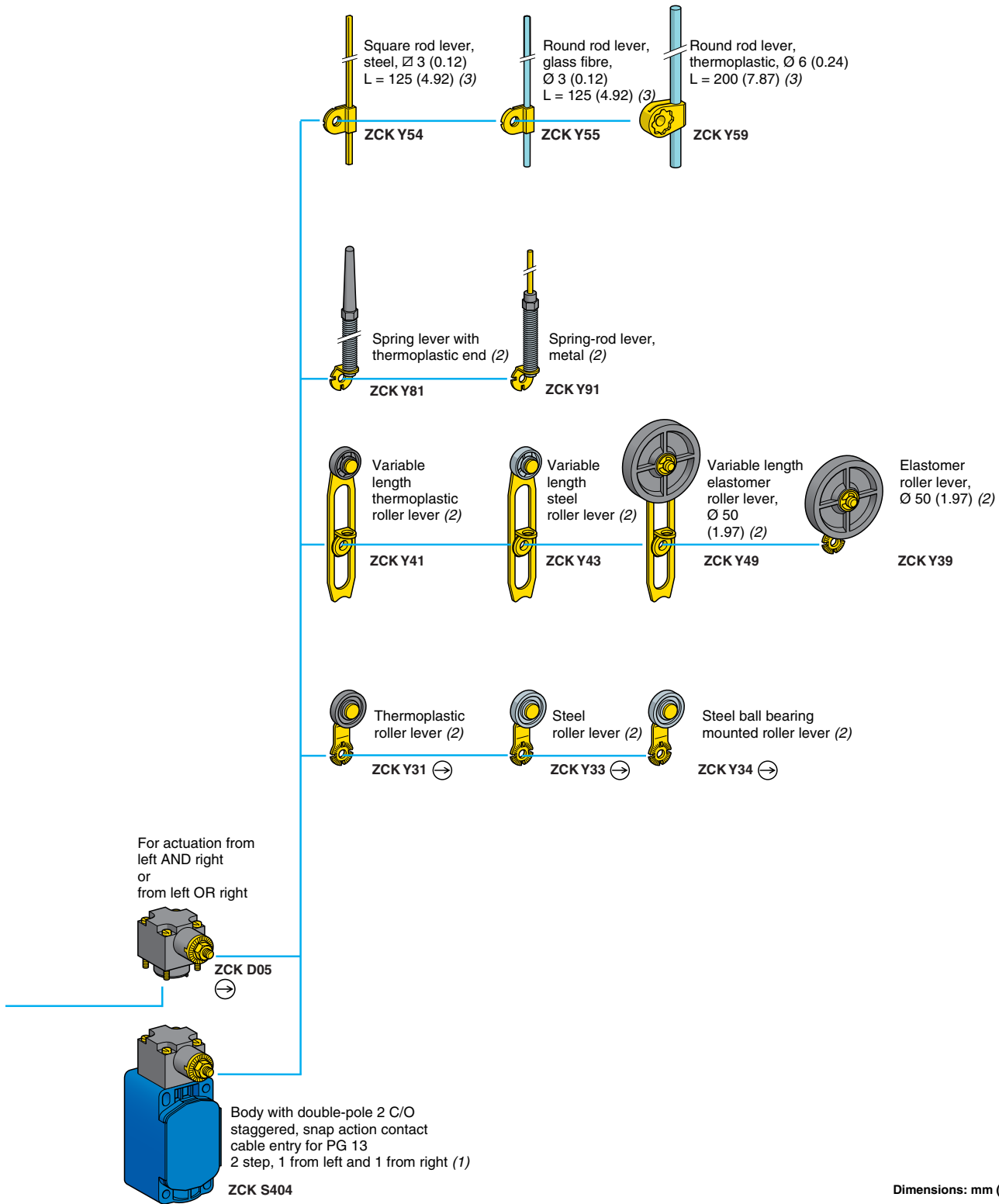

1. For further details, see page 132. For a cable entry tapped ISO M20 x 1.5, add **H29** to the catalog number. Example: ZCKS1 becomes **ZCKS1H29**. To convert PG 13 to 1/2" NPT, use adapter DE9RA1212.
- ⊖: N/C contact with positive opening operation or head assuring positive opening operation, when properly mounted and using a conforming operator.
2. Adjustable throughout 360° in 5° steps, or in 90° steps by reversing the notched washer.
3. Adjustable throughout 360° in 5° steps, or in 45° steps by reversing the lever mounting.

Limit Switches
Osiswitch® Classic, Plastic, Conforming to CENELEC EN 50041
XCKS—Double Insulated, Modular

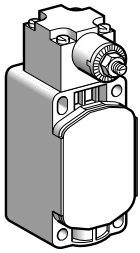
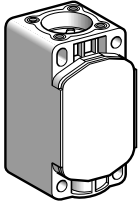

Limit Switches

Bodies with 2-pole contact

Type	With contact block	Function diagram	Positive operation (1)	Cable entry	Catalog number	Weight kg (lb)
1 step	N/C + N/O snap action (XE2S P2151)		⊕	1/2" NPT	ZCKS1	0.080 (0.176)
				ISO M20 x 1.5	ZCKS1H29	0.080 (0.176)
	2 C/O simultaneous, snap action (XES P3021)		—	1/2" NPT	ZCKS2	0.080 (0.176)
				ISO M20 x 1.5	ZCKS2H29	0.080 (0.176)
	N/C + N/O break before make, slow break (XE2N P2151)		⊕	1/2" NPT	ZCKS5	0.080 (0.176)
				ISO M20 x 1.5	ZCKS5H29	0.080 (0.176)
	N/O + N/C make before make, slow break (XE2N P2161)		⊕	1/2" NPT	ZCKS6	0.080 (0.176)
			ISO M20 x 1.5	ZCKS6H29	0.080 (0.176)	
N/C + N/C simultaneous, slow break (XE2N P2141)		⊕	1/2" NPT	ZCKS7	0.080 (0.176)	
			ISO M20 x 1.5	ZCKS7H29	0.080 (0.176)	
N/O + N/O simultaneous, slow break (XE2N P2131)		—	1/2" NPT	ZCKS8	0.080 (0.176)	
			ISO M20 x 1.5	ZCKS8H29	0.080 (0.176)	
N/C + N/C snap action (XE2S P2141)		⊕	1/2" NPT	ZCKS9	0.080 (0.176)	
			ISO M20 x 1.5	ZCKS9H29	0.080 (0.176)	

Bodies with double-pole contact and spring return rotary head

Without operating lever

Type	With contact block	Function diagram	Positive operation (1)	Cable entry	Catalog number	Weight kg (lb)
2 step 1 from left and 1 from right	2 C/O staggered, snap action		—	1/2" NPT	ZCKS404	0.150 (0.331)
				ISO M20 x 1.5	ZCKS404H29	0.150 (0.331)

Bodies with 3-pole contact and 1 cable entry

Type	With contact block	Function diagram	Positive operation (1)	Cable entry	Catalog number	Weight kg (lb)
1 step	N/C + N/O + N/O snap action (XE3S P2151)		⊕	1/2" NPT	ZCKSD31	0.080 (0.176)
				ISO M20 x 1.5	ZCKSD31H29	0.080 (0.176)
	N/C + N/C + N/O snap action (XE3S P2141)		⊕	1/2" NPT	ZCKSD39	0.080 (0.176)
				ISO M20 x 1.5	ZCKSD39H29	0.080 (0.176)
	N/C + N/C + N/O break before make, slow break (XE3N P2141)		⊕	1/2" NPT	ZCKSD37	0.080 (0.176)
				ISO M20 x 1.5	ZCKSD37H29	0.080 (0.176)
	N/C + N/O + N/O break before make, slow break (XE3N P2151)		⊕	1/2" NPT	ZCKSD35	0.080 (0.176)
				ISO M20 x 1.5	ZCKSD35H29	0.080 (0.176)

1. ⊕: N/C contact with positive opening operation or head assuring positive opening operation, when properly mounted and using a conforming operator.

Limit Switches

Osiswitch® Classic, Plastic, Conforming to CENELEC EN 50041

XCKS—Double Insulated, Modular

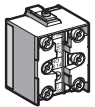
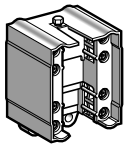
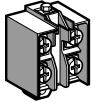

Contact blocks					
Type of contact	Function diagram	For body	Positive operation (1)	Catalog number	Weight kg (lb)
2-pole contact					
N/C + N/O snap action		ZCKS1	⊕	XE2S P2151	0.020 (0.044)
N/C + N/O break before make, slow break		ZCKS5	⊕	XE2N P2151	0.020 (0.044)
2 C/O simultaneous, snap action		ZCKS2	—	XES P3021	0.045 (0.099)
N/O + N/C make before break, slow break		ZCKS6	⊕	XE2N P2161	0.020 (0.044)
N/C + N/C simultaneous, slow break		ZCKS7	⊕	XE2N P2141	0.020 (0.044)
N/O + N/O simultaneous, slow break		ZCKS8	—	XE2N P2131	0.020 (0.044)
N/C + N/C snap action		ZCKS9	⊕	XE2S P2141	0.020 (0.044)
3-pole contact					
N/C + N/O + N/O snap action		ZCKSD31	⊕	XE3S P2151	0.035 (0.077)
N/C + N/C + N/O snap action		ZCKSD39	⊕	XE3S P2141	0.035 (0.077)
N/C + N/C + N/O break before make, slow break		ZCKSD37	⊕	XE3N P2141	0.035 (0.077)
N/C + N/O + N/O break before make, slow break		ZCKSD35	⊕	XE3N P2151	0.035 (0.077)

1. ⊕: N/C contact with positive opening operation or sub-assembly assuring positive opening operation, when properly mounted and using a conforming operator.

Other versions Gold flashed contacts.
Please consult your local sales office.

1/2" NPT Adapter

Description	Catalog number	Weight kg (lb)
PG 13 to 1/2" NPT adapter	DE9RA1212	

Limit Switches

Osiswitch® Classic, Plastic, Conforming to CENELEC EN 50041

XCKS—Double Insulated, Modular

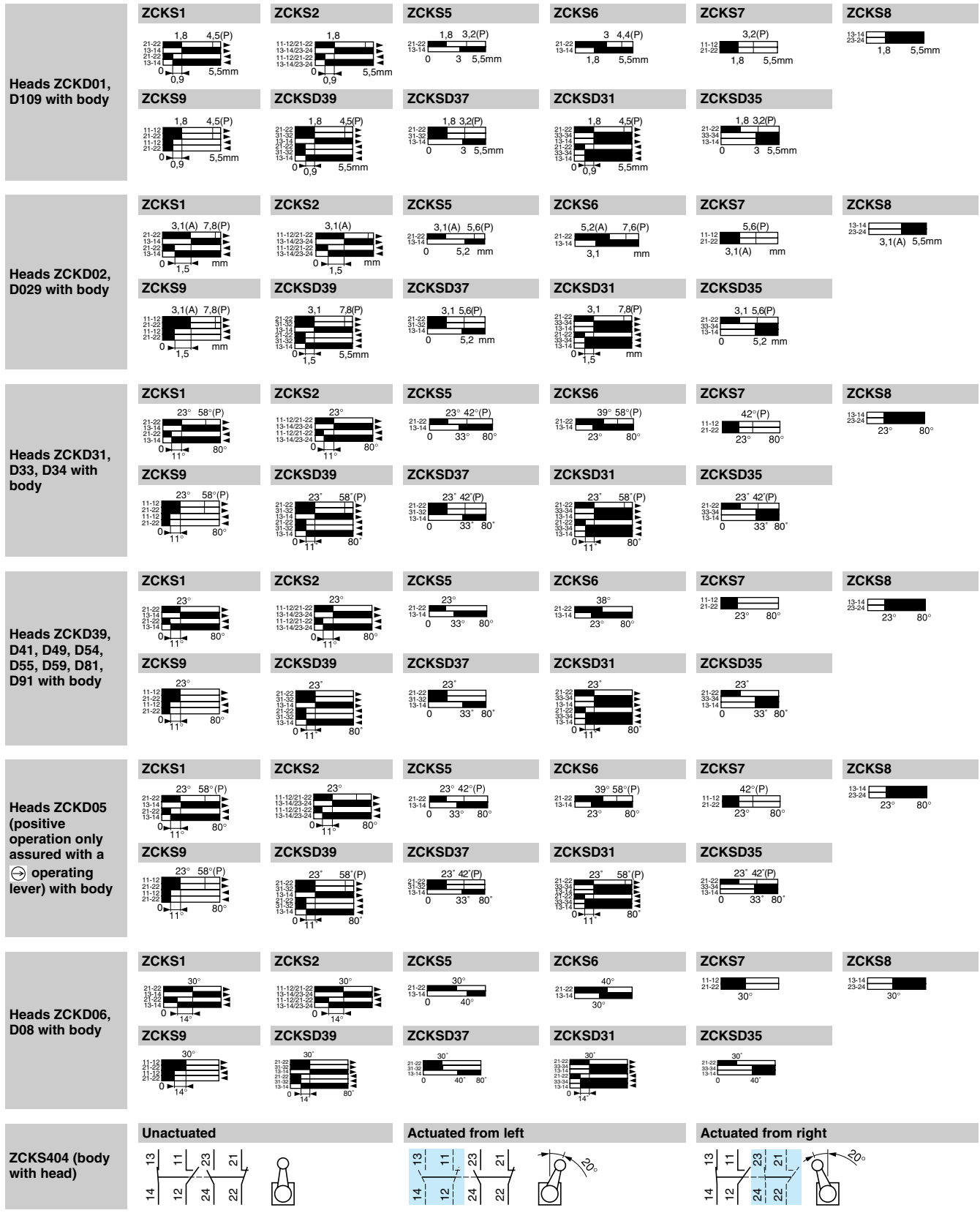

Contact operation contact closed contact open (A) = cam displacement (P) = positive opening point

Limit Switches

Osiswitch® Classic, Plastic, Conforming to CENELEC EN 50041

XCKS—Double Insulated, Modular

Plunger heads

ZCKD01

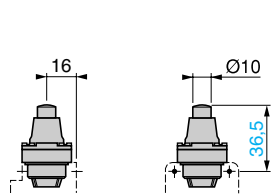

ZCKD019

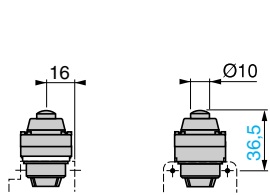

ZCKD02

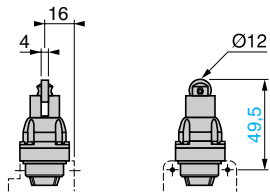

ZCKD029

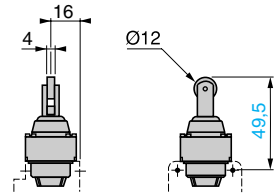

Rotary heads

ZCKD31, D33, D34

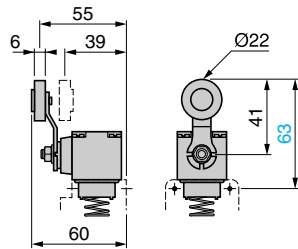

ZCKD39

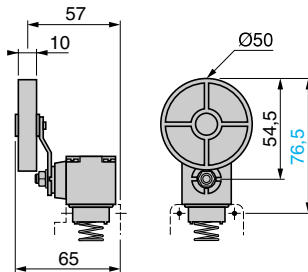

ZCKD41

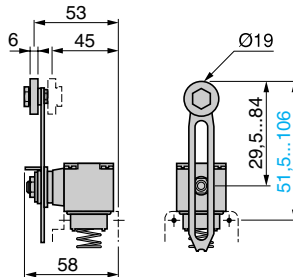

ZCKD49

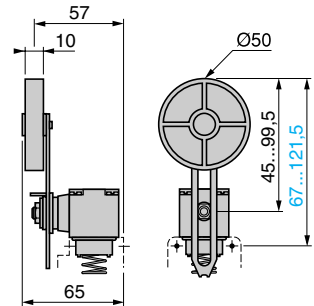

ZCKD54, D55, D59

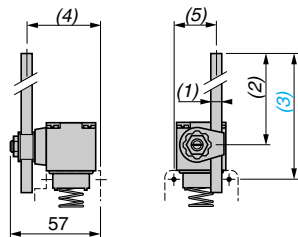

ZCKD81

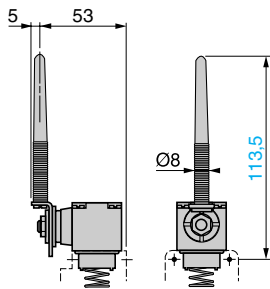

ZCKD91

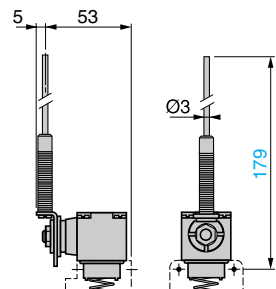

ZCK	(1) rod	(2)	(3)	(4)	(5)
D54	∅ 3, L = 125	115 max.	137 max.	49	24
D55	∅ 3, L = 125	115 max.	137 max.	49	24
D59	∅ 6, L = 200	190 max.	212 max.	46.5	26.2

NOTE: operating lever spindle threaded M6.

Multi-directional heads

ZCKD06

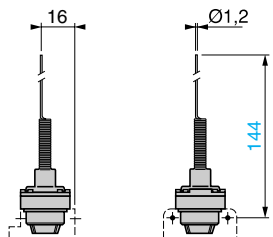

ZCKD08

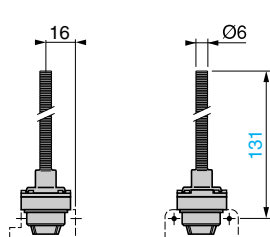

Bodies with contacts

ZCKS1, S2, S5, S6, S7, S8, S9
ZCKS1H29, S2H29, S5H29,
S6H29, S7H29, S8H29, S9H29
ZCKSD3*, SD3*H29

ZCKS404, S404H29

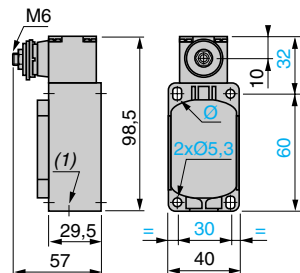
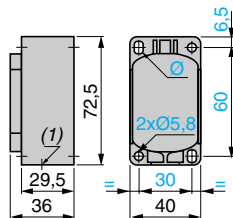

DE9RA1212 (PG 13 to 1/2" NPT adapter)

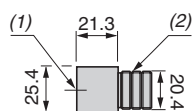

1. Tapped entry for 1/2" NPT conduit
2. PG 13 threaded sleeve

1. 1 tapped entry for PG 13 conduit thread (convertible to 1/2" NPT using adapter DE9RA1212); or 1 tapped entry for ISO M20 x 1.5 conduit thread (with suffix H29 added to the catalog number).
- ∅: 2 elongated holes ∅ 5.3 x 7.3.

Limit Switches

Osiswitch® Classic, For Hoisting, Mechanical Handling, and Conveyer Belt Shift Monitoring

XCR and XCRT

■ XCR

□ With head for rotary movement operators, spring return to off position
1 contact actuation position per direction

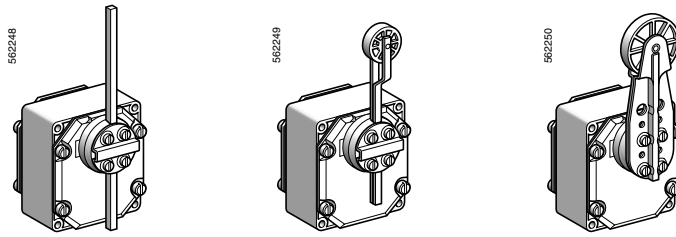

Page 138

□ With head for rotary movement operators, stay put
1 contact actuation position per direction

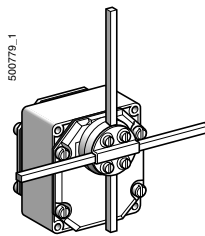

Page 138

■ XCRT

□ With head for rotary movement operators, spring return to off position
2 contact actuation positions per direction
1 actuated at 10°, other contact actuated at 18°

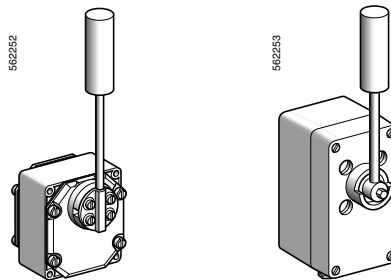

Page 140

Limit Switches

Osiswitch® Classic, For Hoisting, Mechanical Handling, and Conveyor Belt Shift Monitoring XCR and XCRT

Environmental characteristics		
Conforming to standards	Products	IEC/EN 60947-5-1, VDE 0660-200 (CSA C22-2 n° 14 for XCR), CCC (for XCR)
	Machine assemblies	IEC/EN 60204-1, NF C 79-130
Product certifications	Standard version	XCR A, B, E, F: CSA A300
	Special version	XCR A, B, E, F: CSA A300, 1/2" NPT
Protective treatment	Standard version	"TC"
Ambient air temperature		Operation: -25...+70 °C (-13...+158 °F); Storage: -40...+70 °C (-40...+158 °F)
Vibration resistance		9 gn (10...500 Hz)
Shock resistance		XCR A, B, E, F: 68 gn; XCRT: 30 gn (18 ms)
Electric shock protection		Class I conforming to IEC 60536 and NF C 20-030
Degree of protection		XCR A, B, E, F: IP 54 conforming to IEC 60529; IP 54S conforming to NF C 20-010 XCRT: IP 65 conforming to IEC 60529; IP 65S conforming to NF C 20-010
Enclosure		Metal, except XCRT315: polyester
Cable entry		Tapped entry for PG 13 (PG 13.5) conduit thread

Contact block characteristics		
Rated operational characteristics		~ AC-15; A300 (Ue = 240 V, Ie = 3 A) = DC-13; Q300 (Ue = 250 V, Ie = 0.27 A), conforming to IEC 60947-5-1 Appendix A, EN 60947-5-1
Rated insulation voltage		Ui = 500 V degree of pollution 3 conforming to IEC 60947-1 and VDE 0110, group C conforming to NF C 20-040 Ui = 300 V conforming to UL 508, CSA C22-2 n° 14
Rated impulse withstand voltage		U imp = 6 kV conforming to IEC 60947-1, IEC 60664
Positive operation (depending on model)		N/C contacts with positive opening operation to IEC 60947-5-1 Section 3, EN 60947-5-1
Resistance across terminals		≤ 25 mΩ conforming to NF C 93-050 method A or IEC 60255-7 category 3
Short-circuit protection		10 A cartridge fuse type gG (gl)
Cabling	Screw clamp terminals	XE2SP2151: Clamping capacity, min: 1 x 0.34 mm ² , max: 2 x 1.5 mm ² XE2NP2151: Clamping capacity, min: 1 x 0.5 mm ² , max: 2 x 2.5 mm ² XCRT contacts: Clamping capacity, min: 1 x 0.5 mm ² , max: 2 x 2.5 mm ²
Minimum actuation speed		XE2SP2151 and XCRT contacts: 0.01 m/minute (0.03 ft/minute), XE2NP2151: 6 m/minute (19.68 ft/minute)
Electrical durability		Conforming to IEC 60947-5-1 Appendix C Utilization categories AC-15 and DC-13 Maximum operating rate: 3600 operating cycles per hour Load factor: 0.5

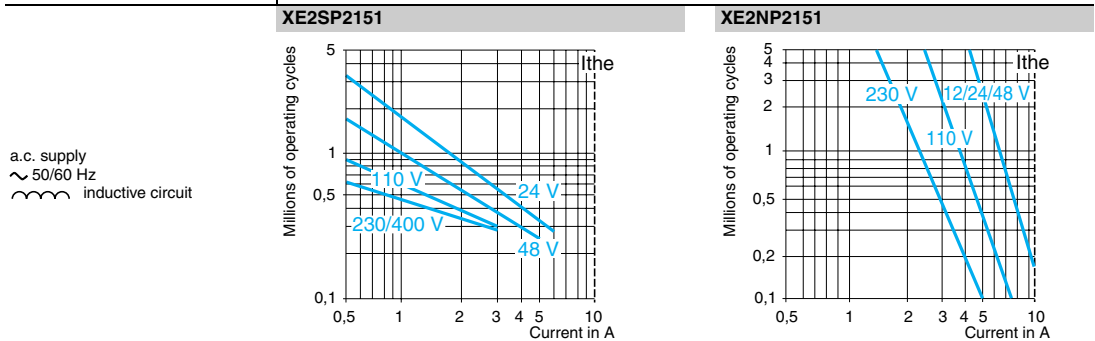

XCRT contacts

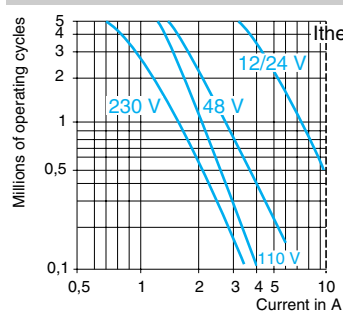

d.c. supply =	Voltage	24 V	48 V	120 V
Power switched in W for 5 million operating cycles W	XE2SP2151	10	7	4
	XE2NP2151	13	9	7
	XCRT contacts	10	7	4

For XE2SP2151 on ~ or = N/C and N/O contacts simultaneously loaded to the values shown with reverse polarity.

Limit Switches

Osiswitch® Classic, For Hoisting and Material Handling

XCR—Complete Switches with One Cable Entry

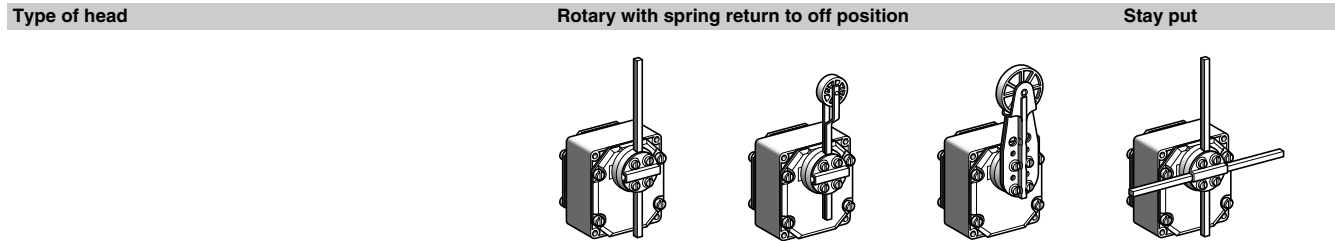

Type of operator	Metal rod, \varnothing 6 mm (0.24 in.)	Thermoplastic roller lever	Large thermoplastic roller lever	Metal rods, \varnothing 6 mm (0.24 in.) crossed or "T" (1)
Maximum displacement	55° in each direction			90° in each direction

1. Crossed rods for XCRE*8, "T" rods for XCRF*7.

Catalog numbers of complete switches (↔ N/C contact with positive opening operation)

Type of head	Type of operator	Rotary with spring return to off position				Stay put				
		XCR A	XCR B	XCR A	XCR B	XCR A	XCR B	XCR A	XCR B	
Two 2-pole 1 N/C + 1 N/O snap action XE2SP2151 	Both contacts operate in each direction	XCRA11 ↔ 	XCRA12 ↔ 	XCRA15 ↔ 	XCRE18 ↔ 	1 contact operates in each direction	XCRB11 ↔ 	XCRB12 ↔ 	XCRB15 ↔ 	XCRF17 ↔
	Both contacts operate in each direction	XCRA51 ↔ 	XCRA52 ↔ 	XCRA55 ↔ 	XCRE58 ↔ 	1 contact operates in each direction	XCRB51 ↔ 	XCRB52 ↔ 	XCRB55 ↔ 	XCRF57 ↔

Weight, kg (lb)	1.110	1.145	1.155	1.135
Contact operation	(P) = positive opening point			1. 1 st contact 2. 2 nd contact

Complementary characteristics not shown under general characteristics (page 127)

Maximum actuation speed	1.5 m/s (4.92 ft/s)		
Minimum torque	For tripping	0.45 N•m (3.98 lb-in)	0.60 N•m (5.31 lb-in)
	For positive opening	0.75 N•m (6.64 lb-in)	0.70 N•m (6.20 lb-in)
Cable entry	1 entry tapped for PG 13 conduit thread conforming to NF C 68-300 (DIN PG 13.5). Clamping capacity 9 to 12 mm (0.35 to 0.47 in.). 1/2" NPT with adapter DE9RA1212.		

Limit Switches

Osiswitch® Classic, For Hoisting and Material Handling

XCR—Complete Switches with One Cable Entry



XCRZ02

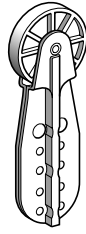

XCRZ05

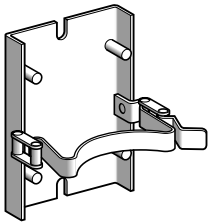

XCRZ09

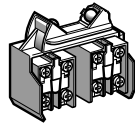

XCRZ1•

Separate components

Description	For switches	Type	Catalog number	Weight kg (lb)
Rod, \varnothing 6 mm (0.24 in.)	XCRA XCRB	L = 200 mm (7.87 in.)	XCRZ03	0.020 (0.044)
		L = 300 mm (11.81 in.)	XCRZ04	0.030 (0.066)
Roller lever thermoplastic roller	XCRA XCRB	—	XCRZ02	0.050 (0.110)
Large roller lever thermoplastic roller	XCRA XCRB	—	XCRZ05	0.090 (0.198)
Quick mounting/ release bracket	XCRA, XCRB XCRE, XCRF	—	XCRZ09	0.520 (1.146)
Contact block (2 contacts) with mounting plate	XCRA, XCRB XCRE, XCRF	2-pole 1 N/C + 1 N/O snap action	XCRZ12	0.135 (0.298)
		2-pole 1 N/C + 1 N/O break before make, slow break	XCRZ15	0.135 (0.298)
Description	Application	Sold in lots of	Unit catalog number	Weight kg (lb)
Adapter	PG 13.5 to ISO M20 x 1.5	5	DE9RA13520	0.050 (0.110)
Adapter	PG 13.5 to 1/2" NPT	5	DE9RA1212	0.050 (0.110)

Limit Switches

Osiswitch® Classic, For Conveyor Belt Shift Monitoring

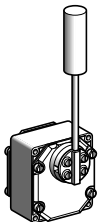
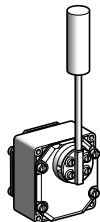
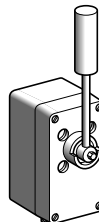
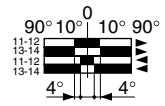
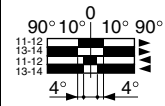
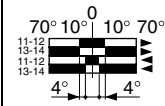
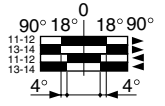
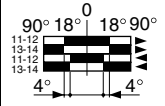
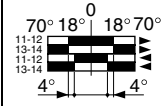
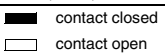

XCRT—Complete Switches with One Cable Entry and 1/2" NPT Adapter Included

Type of switch	Standard	For corrosive atmospheres	
			
Features	Zinc alloy enclosure Colour: industrial blue Zinc plated steel lever, spring return to off position Cam angles: 10° and 18° Maximum displacement: 90°	Zinc alloy enclosure Colour: blue Stainless steel lever, spring return to off position Cam angles: 10° and 18° Maximum displacement: 90°	Glass reinforced polyester enclosure Colour: grey Stainless steel lever, spring return to off position Cam angles: 10° and 18° Maximum displacement: 70°
Catalog numbers of complete switches			
2 single-pole C/O snap action	XCRT115	XCRT215	XCRT315
1 st contact			
2 nd contact			
Weight, kg (lb)	1.170 (2.579)	1.170 (2.579)	1.520 (3.351)
Contact operation			

Complementary characteristics not shown under general characteristics (page 127)

Minimum tripping torque	1.0 N•m (8.85 lb-in)
Cable entry	1 entry tapped for PG 13 conduit thread conforming to NF C 68-300 (DIN PG 13.5) Clamping capacity 9 to 12 mm (0.35 to 0.47 in.) 1/2" NPT with adapter DE9RA1212 included

Switch operation

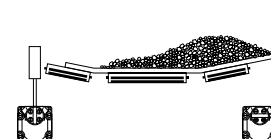
Normal position	Fault signalling	Stopping of the conveyor belt	Maximum rotation
			

Dimensions:
page 143

Limit Switches

Osiswitch® Classic, For Conveyor Belt Shift Monitoring

XCRT—Complete Switches with One Cable Entry and 1/2" NPT Adapter Included

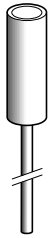

XCRZ901

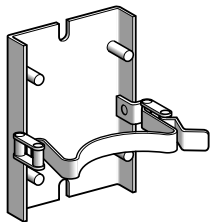

XCRZ09

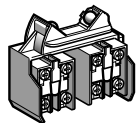

XCRZ42

Separate components

Description	Type	For switches	Catalog number	Weight kg (lb)
Roller with lever	Zinc plated steel	XCRT115 XCRT215	XCRZ901	0.230 (0.507)
	Stainless steel	XCRT115 XCRT215	XCRZ902	0.230 (0.507)
		XCRT315	XCRZ903	0.230 (0.507)
Quick mounting/release bracket	—	XCRT115 XCRT215	XCRZ09	0.520 (1.146)
Contact block (2 contacts) with mounting plate	Single-pole C/O snap action	XCRT•15	XCRZ42	0.135 (0.298)

Description	Application	Sold in lots of	Unit catalog number	Weight kg (lb)
Adapter	PG 13.5 to ISO M20 x 1.5	5	DE9RA13520	0.050 (0.110)
Adapter	PG 13.5 to 1/2" NPT	5	DE9RA1212	0.050 (0.110)

Limit Switches

Osiswitch® Classic, For Hoisting, Mechanical Handling, and Conveyor Belt Shift Monitoring XCR and XCRT

XCRA11, B11, A51, B51

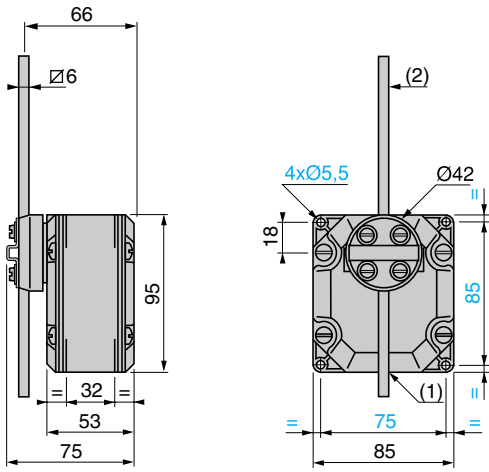

XCRA12, B12, A52, B52

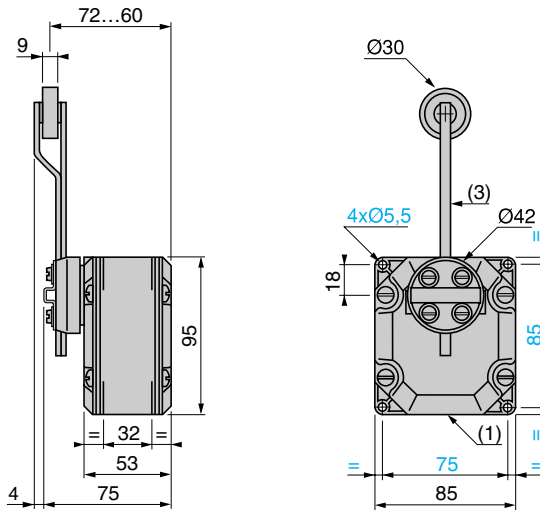

XCRA15, B15, A55, B55

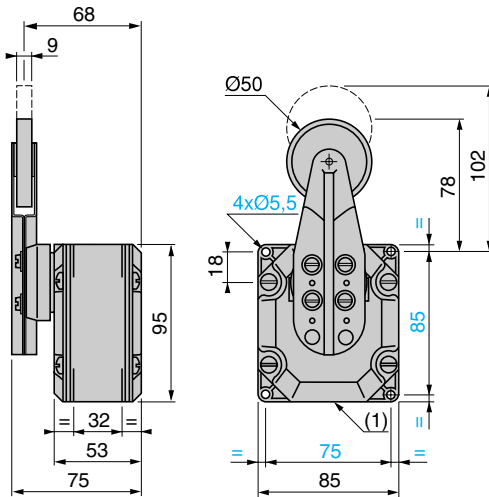

XCREF18, E58, F17, F57

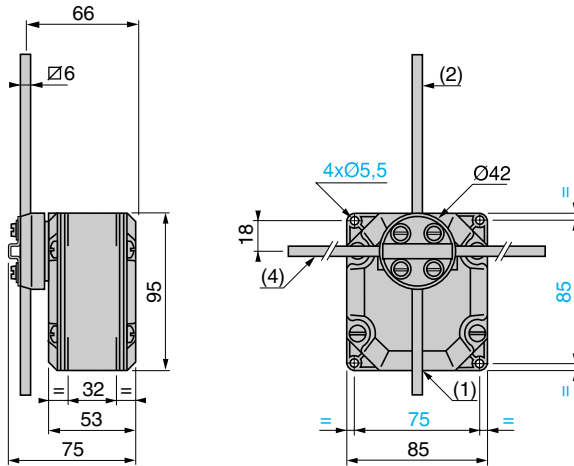

1. 1 tapped entry for PG 13 conduit thread.
2. Rod length: 200 mm (7.87 in.).
3. Rod + roller length: 160 mm (6.30 in.).
4. Rod length: 300 mm (11.81 in.) for XCRF17 and F57, 200 mm (7.87 in.) for XCR E18 and E58.

Supplementary mounting using 2 adjustable lugs (included with switch)

Horizontally positioned

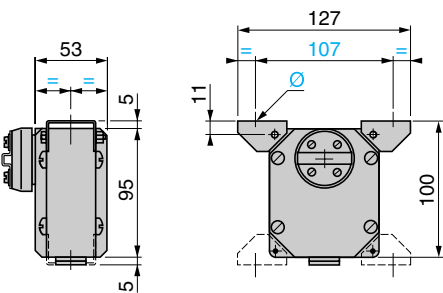

Vertically positioned

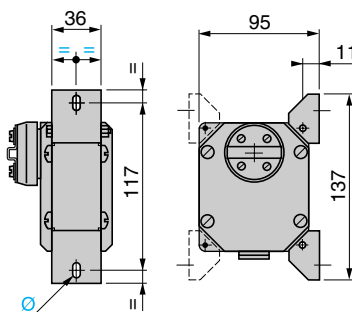

Quick mounting/release bracket XCRZ09

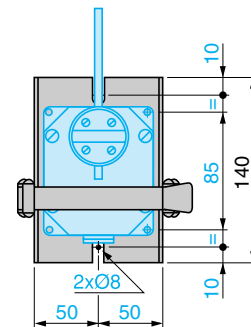

Ø: 1 elongated hole Ø 6 x 8.

Characteristics:
pages 137 and 138

Catalog numbers:
page 138

Operation:
page 138

Limit Switches

Limit Switches

Osiswitch® Classic, For Hoisting, Mechanical Handling, and Conveyor Belt Shift Monitoring XCR and XCRT

XCRT115, T215

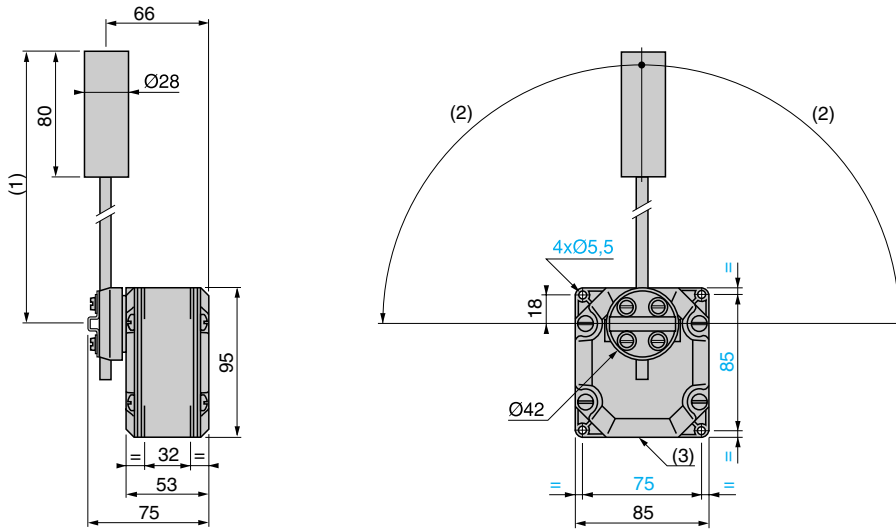

XCRT315

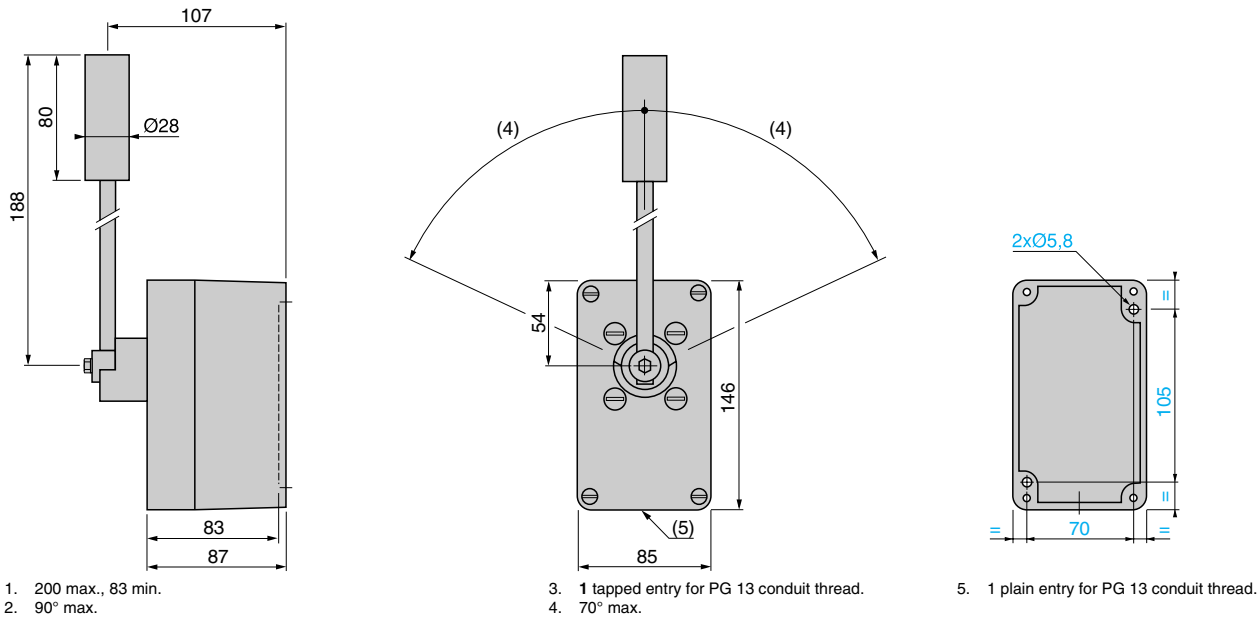

1. 200 max., 83 min.
2. 90° max.

3. 1 tapped entry for PG 13 conduit thread.
4. 70° max.

5. 1 plain entry for PG 13 conduit thread.

Supplementary mounting using 2 adjustable lugs (included with XCRT115 and T215)

Horizontally positioned

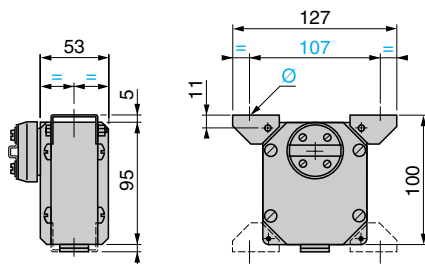

Ø: 1 elongated hole Ø 6 x 8.

Vertically positioned

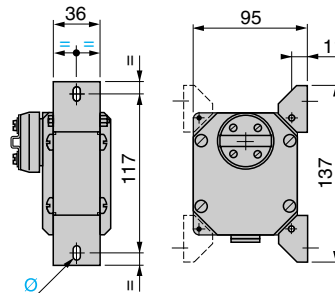

Quick mounting/release bracket XCRZ09

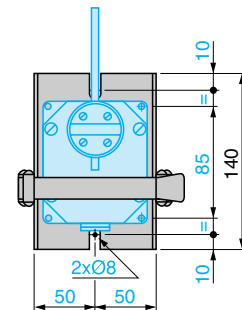

Characteristics:
pages 137 and 140

Catalog numbers:
page 140

Operation:
page 141

Limit Switches

Osiswitch® Classic, For Material Handling

XC1AC

■ XC1AC
with slow break contacts

□ With head for linear movement (plunger)

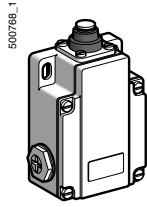

Page 146

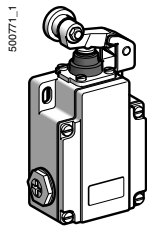
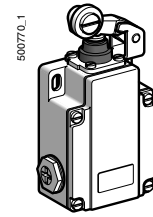
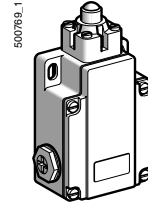

Page 146

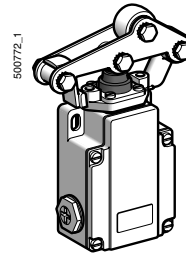

Limit Switches

Osiswitch® Classic, For Material Handling











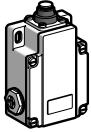
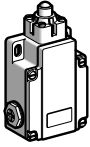

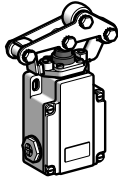
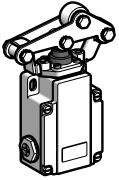

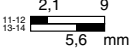
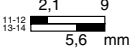
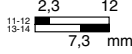
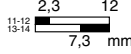
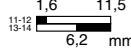
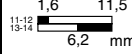

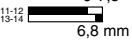
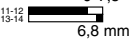
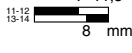
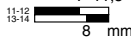
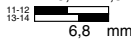
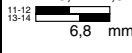

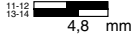
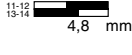
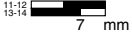
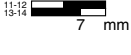
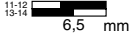
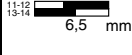







XC1AC

Environmental characteristics																																								
Conformity to standards	IEC/EN 60947-5-1, IEC 60337-1, VDE 0660-200, CSA C22-2 n° 14																																							
Product certifications	Special version CSA 600 V (ac) HD																																							
Protective treatment	Version Standard "TC", special "TH"																																							
Ambient air temperature	For operation - 25...+70 °C (-13...+158 °F)																																							
	For storage - 40...+70 °C (-40...+158 °F)																																							
Operating position	All positions																																							
Vibration resistance	9 gn (10...500 Hz) conforming to IEC 60068-2-6																																							
Shock resistance	95 gn (11 ms) conforming to IEC 60068-2-27																																							
Electric shock protection	Class I conforming to IEC 60536 and NF C 20-030																																							
Degree of protection	IP 65 conforming to IEC 60529 and NF C 20-010																																							
Mechanical durability	10 million operating cycles																																							
Cable entry	3 tapped entries for PG 13 conduit thread																																							
Contact block characteristics																																								
Conventional thermal current	10 A																																							
Rated insulation voltage	Slow break contact blocks ~ 500 V and = 600 V conforming to IEC 60947-5-1, NF C 20-040 ~ and = 600 V conforming to CSA C22-2 n° 14																																							
Resistance across terminals	≤ 8 mΩ																																							
Minimum tripping force	XC1AC1•1 : 33 N (7.42 lb); XC1AC1•6 : 23 N (5.17 lb); XC1AC1•7 : 29 N (6.52 lb)																																							
Terminal referencing	Conforming to CENELEC EN 50013																																							
Short-circuit protection	10 A cartridge fuse type gG (gl)																																							
Electrical durability	Conforming to IEC 60947-5-1 Appendix C Utilization categories AC-15 and DC-13 Maximum operating rate: 3600 operating cycles/hour Load factor: 0.5																																							
	<table border="1"> <thead> <tr> <th colspan="4">Slow break contact blocks</th> </tr> <tr> <th colspan="4">Power switched in VA</th> </tr> <tr> <th>Voltage V</th> <th>48</th> <th>110</th> <th>230</th> </tr> </thead> <tbody> <tr> <td>a.c. supply ~ 50/60 Hz ~ inductive circuit</td> <td>For 1 million operating cycles</td> <td>450</td> <td>900</td> <td>1900</td> </tr> <tr> <td></td> <td>For 3 million operating cycles</td> <td>170</td> <td>350</td> <td>430</td> </tr> <tr> <th colspan="4">Power switched in W</th> </tr> <tr> <th>Voltage V</th> <th>48</th> <th>110</th> <th>230</th> </tr> <tr> <td>d.c. supply = ~ inductive circuit</td> <td>For 1 million operating cycles</td> <td>100</td> <td>100</td> <td>95</td> </tr> <tr> <td></td> <td>For 3 million operating cycles</td> <td>35</td> <td>40</td> <td>33</td> </tr> </tbody> </table>	Slow break contact blocks				Power switched in VA				Voltage V	48	110	230	a.c. supply ~ 50/60 Hz ~ inductive circuit	For 1 million operating cycles	450	900	1900		For 3 million operating cycles	170	350	430	Power switched in W				Voltage V	48	110	230	d.c. supply = ~ inductive circuit	For 1 million operating cycles	100	100	95		For 3 million operating cycles	35	40
Slow break contact blocks																																								
Power switched in VA																																								
Voltage V	48	110	230																																					
a.c. supply ~ 50/60 Hz ~ inductive circuit	For 1 million operating cycles	450	900	1900																																				
	For 3 million operating cycles	170	350	430																																				
Power switched in W																																								
Voltage V	48	110	230																																					
d.c. supply = ~ inductive circuit	For 1 million operating cycles	100	100	95																																				
	For 3 million operating cycles	35	40	33																																				

Limit Switches

Osiswitch® Classic, For Material Handling

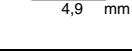
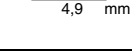
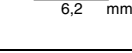
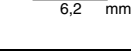
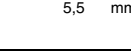
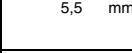
XC1AC—Complete Switches with Slow-Break Contacts and 1/2" NPT Adapter Included

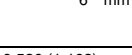
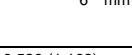
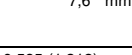
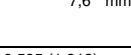
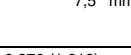
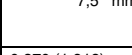
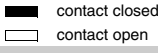
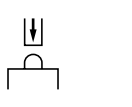
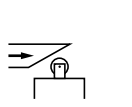
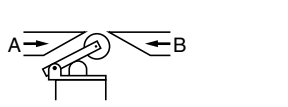
Type of head	Plunger					
						
Type of operator	End plunger	End ball bearing plunger	Roller lever	Offset roller lever	Reinforced roller lever	Roller lever on needle roller bearing
Catalog numbers of complete switches						
Single pole C/O slow break ZC1AZ11	XC1AC111	XC1AC115	XC1AC116	XC1AC118	XC1AC117	XC1AC119
						
2-pole N/C + N/O break before make, slow break ZC1AZ12	XC1AC121	XC1AC125	XC1AC126	XC1AC128	XC1AC127	XC1AC129
						
2-pole N/O + N/C make before break, slow break ZC1AZ13	XC1AC131	XC1AC135	XC1AC136	XC1AC138	XC1AC137	XC1AC139
						
2-pole N/C + N/C simultaneous, slow break ZC1AZ14	XC1AC141	XC1AC145	XC1AC146	XC1AC148	XC1AC147	XC1AC149
						
2-pole N/O + N/O simultaneous, slow break ZC1AZ15	XC1AC151	XC1AC155	XC1AC156	XC1AC158	XC1AC157	XC1AC159
						
2-pole N/C + N/C staggered, slow break ZC1AZ16	XC1AC161	XC1AC165	XC1AC166	XC1AC168	XC1AC167	XC1AC169
						
2-pole N/O + N/O staggered, slow break ZC1AZ17	XC1AC171	XC1AC175	XC1AC176	XC1AC178	XC1AC177	XC1AC179
						
Weight, kg (lb)	0.530 (1.168)	0.530 (1.168)	0.595 (1.312)	0.595 (1.312)	0.870 (1.918)	0.870 (1.918)
Contact operation						
Complementary characteristics not shown under general characteristics (page 137)						
Switch actuation	On end	By 30° cam				
Type of actuation						
Maximum actuation speed	0.5 m/s (1.64 ft/s)	Direction A: 1 m/s (3.28 ft/s); Direction B: 0.5 m/s (1.64 ft/s) (1)				
Cable entry	3 tapped entries for PG 13 (DIN PG 13.5) conduit thread, clamping capacity 9 to 12 mm (0.35 to 0.47 in.) (2 entries fitted with blanking plug) 1/2" NPT with adapter DE9RA1212					
Connection	Screw terminals. Clamping capacity: min 1 x 0.5 mm ² , max 1 x 2.5 mm ²					

1. For a 45° cam the maximum actuation speed becomes 0.5 m/s (1.64 ft/s) and for a 15° cam, 1 m/s (3.28 ft/s).

Limit Switches

Osiswitch® Classic, For Material Handling

XC1AC—Complete Switches with Slow-Break Contacts and 1/2" NPT Adapter Included

XC1AC1•1

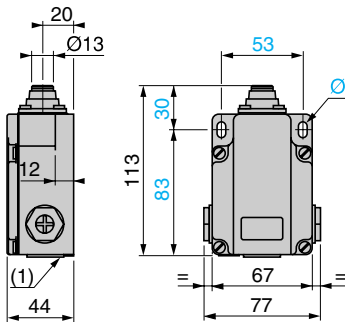

XC1AC1•5

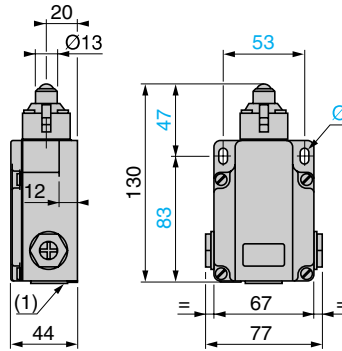

XC1AC1•6

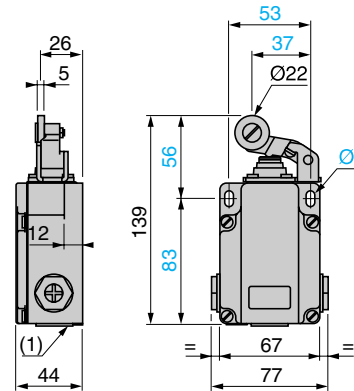

XC1AC1•8

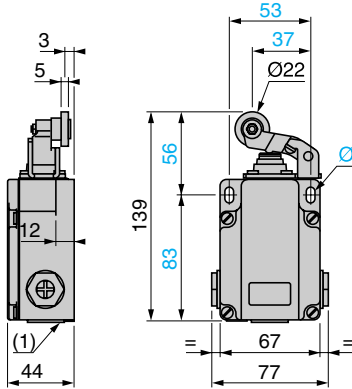

XC1AC1•7, XC1AC1•9

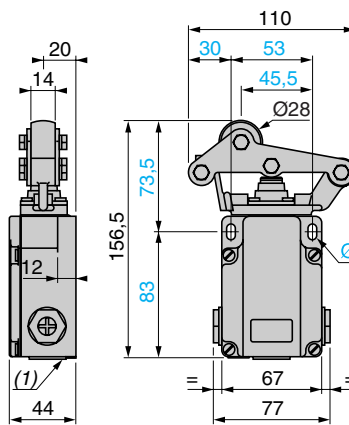

DE9RA1212

(PG 13 to 1/2" NPT adapter)

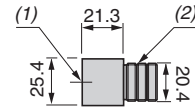

1. Tapped entry for 1/2" NPT conduit
2. PG 13 threaded sleeve

1. 3 tapped entries for PG 13 conduit thread or ISO 20 with adapter DE9RA1620.
- Ø: 2 elongated holes Ø 6.5 x 10.

Limit Switches

Osiswitch® Classic, For Material Handling

XC1AC—Renewal Parts

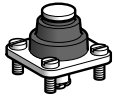

ZC1AC001

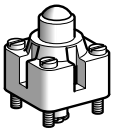

ZC1AC005

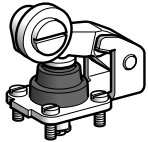

ZC1AC006

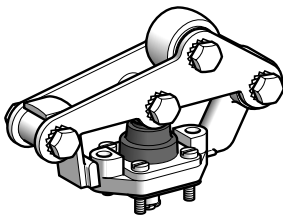

ZC1AC007
ZC1AC009

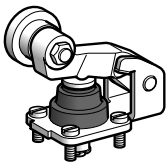

ZC1AC008

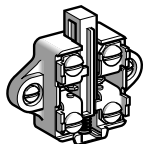

ZC1AZ1•

Plunger heads				
Type of operator	Maximum actuation speed	Type of actuation	Catalog number	Weight kg (lb)
For actuation on end				
End plunger	0.5 m/s (1.64 ft/s)		ZC1AC001	0.035 (0.077)
For actuation by 30° cam				
End ball bearing plunger	0.5 m/s (1.64 ft/s)		ZC1AC005	0.050 (0.110)
Roller lever	Direction A 1 m/s (3.28 ft/s) Direction B 0.5 m/s (1.64 ft/s)		ZC1AC006	0.100 (0.220)
Reinforced roller lever	Direction A 1 m/s (3.28 ft/s) Direction B 0.5 m/s (1.64 ft/s)		ZC1AC007	0.375 (0.827)
Offset roller lever	Direction A 1 m/s (3.28 ft/s) Direction B 0.5 m/s (1.64 ft/s)		ZC1AC008	0.100 (0.220)
Roller lever on needle roller bearing	Direction A 1 m/s (3.28 ft/s) Direction B 0.5 m/s (1.64 ft/s)		ZC1AC009	3.380 (7.452)
Contact blocks				
Type of contact	Function diagram	Catalog number	Weight kg (lb)	
C/O, single pole		ZC1AZ11	0.040 (0.088)	
N/C + N/O break before make		ZC1AZ12	0.045 (0.099)	
N/O + N/C make before break		ZC1AZ13	0.040 (0.088)	
N/C + N/C simultaneous		ZC1AZ14	0.045 (0.099)	
N/O + N/O simultaneous		ZC1AZ15	0.045 (0.099)	
N/C + N/C staggered		ZC1AZ16	0.040 (0.088)	
N/O + N/O staggered		ZC1AZ17	0.040 (0.088)	
Adapter plate				
Description	Catalog number	Weight kg (lb)		
Mounting plate (For replacing an old version type RN-67522 limit switch with an XC1AC limit switch)	ZC1AZ8	3.380 (7.452)		

Limit Switches

Osiswitch® Classic, For Material Handling

XC1AC—Renewal Parts

Dimensions

ZC1AC001

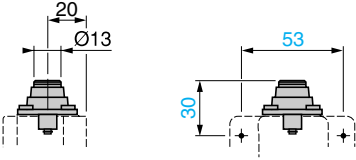

ZC1AC005

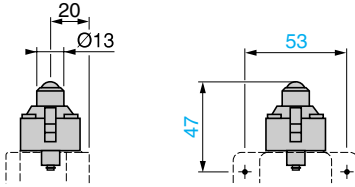

ZC1-AC006

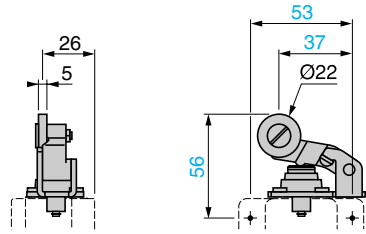

ZC1AC008

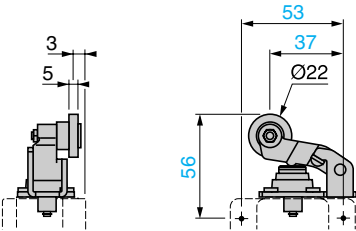

ZC1AC007, AC009

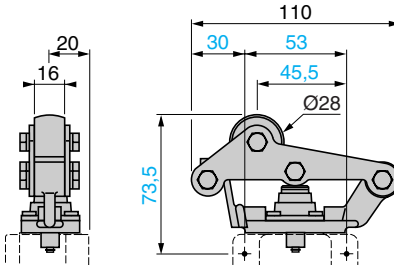

DE9RA1212
(PG 13 to 1/2" NPT adapter)

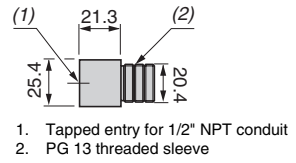

Limit Switches
Table of Contents
Class 9007 Limit Switches

Snap Action Industrial Switches	152
Miniature	155
Miniature Enclosed Reed	160
9007AW Heavy Duty Industrial	161
9007C Heavy Duty Industrial—Plug-in Body, Metal	162
9007C Heavy Duty Industrial—Non-Plug-in Body, Metal	198
9007C Heavy Duty Industrial	206
9007T and FT Severe Duty Mill and Foundry Switches	214
9007T Severe Duty Mill Switches	216
9007FT Severe Duty Foundry Switches	218
R.B.Denison® Lox-Switch™ L Severe Duty Mill and Foundry Switches	226
Interpretation of Catalog Numbers	239

Limit Switches

Snap Action Industrial Switches

Class 9007

Industrial Snap Switches and Limit Switches without Enclosures

Industrial Snap Switches have been incorporated in many Square D® products such as timers, specialty push buttons, foot switches, operating mechanisms, door interlocks, motor control centers, position switches, and many other control products.

- **Recommended Actuator**—An adjustable actuator is recommended. If a non-adjustable actuator is used, a resilient type or a mechanical stop should be used to prevent bottoming of button mechanism.
- **Adjustable Actuator Overtravel**—Minimum recommended overtravel in both trip and reset directions is 0.015 in. (0.38 mm).
- **Non-Adjustable Actuator Total Travel**—Maximum differential limit plus 0.030 in. (0.76 mm). Example: 0.076 in. (1.9 mm) for Type AO2.
- **Non-Adjustable Actuator Total Travel**—Fully retracted—from mounting surface, at least 0.139 in. (3.5 mm) for Type AO1 and 0.160 in. (4.0 mm) for Types AO2 and CO3. Fully engaged—from mounting surface, at least 0.061 in. (1.5 mm) but not closer than 0.045 in. (1.1 mm).



Quick Make and Break

Type of Operator	Contact Arrangement •	Type	Type of Operator	Contact Arrangement •	Type	Type of Operator	Contact Arrangement •	Type	
Basic Snap Switch	1 N.O. 1 N.C.	AO 1	Rigid Roller Lever Type	2 N.O. 2 N.C.	CB 31 (RH) ▲	Roller Plunger Type Panel Mounting Non-Oiltight	1 N.O. 1 N.C.	AP 321	
	1 N.C.	AO 1A			CB 32 (LH) ▲		1 N.O. 1 N.C.	AP 324 †	
	1 N.O.	AO 1B			CB 41 ▲ (without Side Mtg. Bracket)		2 N.O. 2 N.C.	CP 321	
	1 N.O. 1 N.C.	AO 2			CB 33 (RH) ◆		2 N.O. 2 N.C.	CP 324 †	
	1 N.C.	AO 6 (Plug-in)			CB 34 (LH) ◆		Operator Only	AP 301 *	
	1 N.C.	AO 2A	Rigid Roller Lever Type One Way Roller	1 N.O. 1 N.C.	AB 25 (RH)	Roller Plunger Type Panel Mounting Oiltight	1 N.O. 1 N.C.	AP 304 † *	
	1 N.O.	AO 2B		1 N.C.	AB 26 (LH)		1 N.O. 1 N.C.	AP 323	
	2 N.O. 2 N.C.	CO 3		2 N.O. 2 N.C.	CB 35 (RH)		2 N.O. 2 N.C.	AP 325 †	
	2 N.O.	CO 6 (Plug-in)	Cabinet Door Type	2 N.O. 2 N.C.	CB 36 (LH)	Roller Plunger Type Panel Mounting Oiltight	2 N.O. 2 N.C.	CP 323	
	Two Stage 2 N.O. 2 N.C.	CO 7		1 N.O. 1 N.C.	AC 1		2 N.O. 2 N.C.	CP 325 †	
Rigid Roller Lever Type	1 N.O. 1 N.C.	AB 21 (RH) ▲	Plunger Type Panel Mounting	1 N.O. 1 N.C.	2 N.O. 2 N.C.	Mushroom Button Type Panel Mounting	1 N.O. 1 N.C.	AP 303 *	
		AB 22 (LH) ▲			2 N.O. 2 N.C.		1 N.O. 1 N.C.	AP 305 † *	
		AB 41 ▲ (without Side Mtg. Bracket)			2 N.O. 2 N.C.		CP 221	1 N.O. 1 N.C.	AP 222
		AB 23 (RH) ◆			Operator Only		AP 201 *	2 N.O. 2 N.C.	CP 222
		AB 24 (LH) ◆			Operator Only		AP 202 *	Operator Only	AP 202 *

- Single-pole snap switches that contain two double-break contact elements (1 N.O. and 1 N.C.) must be used on circuits of the same polarity. Two-pole snap switches contain two electrically separated sets of contact elements allowing use on circuits of opposite polarity. Each set contains two double-break contact elements (1 N.O. and 1 N.C.) that must be used on circuits of the same polarity.
- † Roller turned 90° from standard (perpendicular to mounting holes).
- ▲ With 0.22 in. (5.6 mm) width roller.
- ◆ With 0.47 in. (12.0 mm) width roller.
- * For use with Type AO and CO basic switches.

Maximum Current Ratings For Control Contacts—All Types

Switch Type	Contacts	Direct Opening Contacts Meet IEC 60947-5-1 Requirements	Voltage	AC—50 or 60 Hz					Resistive 75% Power Factor	Voltage	DC		AC or DC Continuous Carrying Amperes
				Inductive 35% Power Factor				Make and Break Amperes			Inductive and Resistive Make and Break Amperes		
				Make		Break					Single Pole	Double Pole	
AO1, AC	SPDT Form Z SPST • Form X or Y	No	120	40	4800	15	1800	15	125	0.5	0.25	15	
			240	20	4800	10	2400	10	250	0.25	0.1	15	
			480	10	4800	6	2880	6	600	0.05	—	15	
			600	8	4800	5	3000	5	—	—	—	15	
			—	—	—	—	—	—	—	—	—	—	—
AW, AO2 and AO6, AB, AP	SPDT Form Z SPST • Form X or Y	No	120	40	4800	15	1800	15	125	2.0	0.5	15	
			240	20	4800	10	2400	10	250	0.5	0.2	15	
			480	10	4800	6	2880	6	600	0.1	0.02	15	
			600	8	4800	5	3000	5	—	—	—	15	
			—	—	—	—	—	—	—	—	—	—	—
AW, CO3 and CO6, CB, CC, CP	DPDT Form ZZ DPST Form AA or BB	No	120	30	3600	3	360	3	125	1.0	0.2	10	
			240	15	3600	1.5	360	1.5	250	0.3	0.1	10	
			480	7.5	3600	0.75	360	0.75	600	0.1	—	10	
			600	6	3600	0.6	360	0.6	—	—	—	10	
			—	—	—	—	—	—	—	—	—	—	—

Acceptable Wire Size 14–22 AWG
Recommended Terminal Clamp Torque 6–9 lb-in (0.7–1 N•m)



Limit Switches

Snap Action Industrial Switches

Class 9007

Approximate Dimensions and Operating Data, Types AO, CO, AP, and CP

Class 9007 Type AO, Single-Pole Snap Switch

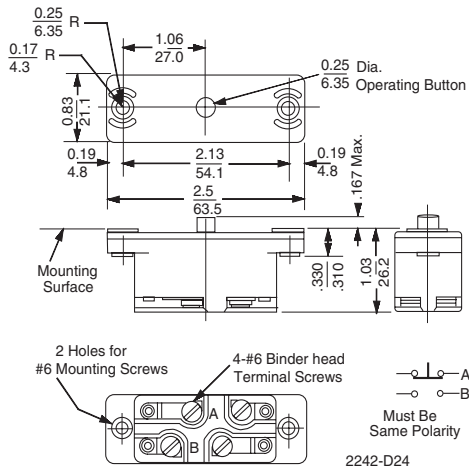

Class 9007 Type CO, Two-Pole Snap Switch

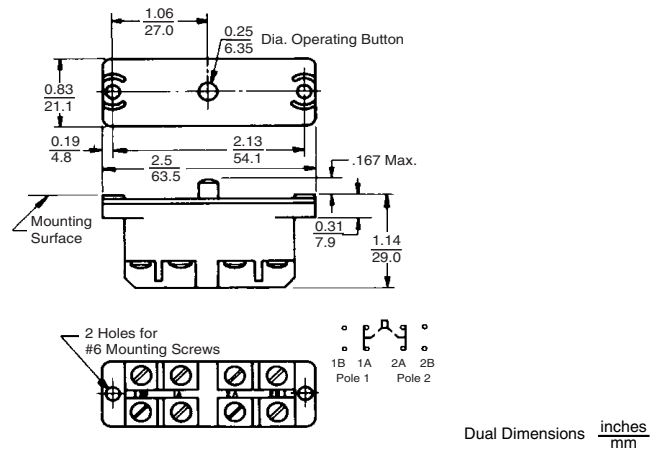

	Operating Data, in. (mm)	
	AO1, 1A, 1B	AO2, 2A, 2B
Pre-travel	0.057–0.074 (1.4–1.8)	0.057–0.074 (1.4–1.8)
Differential	0.015–0.025 (0.6–0.6)	0.035–0.046 (0.9–1.16)
Total travel	0.103–0.125 (2.6–3.2)	0.103–0.125 (2.6–3.2)
Operating force	7–11 oz (0.05–0.08 N)	10–14 oz (0.07–0.1 N)

	Operating Data, in. (mm)	
	CO3	CO7
Pre-travel 1st stage	0.057–0.074 (1.4–1.8)	0.035–0.060 (0.9–1.5)
Pre-travel 2nd stage	—	0.060–0.085* (1.5–2.1)
Differential	0.025–0.046 (0.6–1.16)	0.010–0.020 (0.25–0.50)
Total travel	0.103–0.125 (2.6–3.2)	—
Operating force	7–12 oz (0.05–0.084 N)	7–12 oz (0.05–0.084 N)

* Separation between first and second stage trip points is 0.020–0.025 (0.5–0.6).
 Note: Shipping weight of Type AO and CO is 0.25 lb (0.11 kg).

Type AP201, 221, and CP221

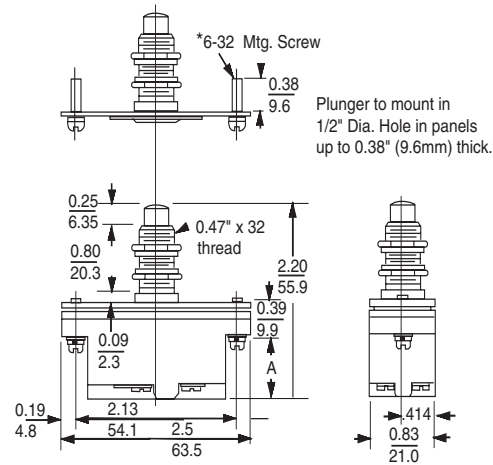

NOTE: Type AP221 shown.

Type	Dimension A
AP221	0.70 (17.8)
CP221	0.80 (20.3)

Operating Data		
	AP221	CP221
Pretravel	0.070–0.089 (1.8–2.2)	0.070–0.089 (1.8–2.2)
Differential	0.035–0.046 (0.9–1.2)	0.025–0.046 (0.9–1.2)
Overtravel	0.161–0.180 (4.1–4.6)	0.161–0.180 (4.1–4.6)
Total travel	0.231–0.269 (5.8–6.8)	0.231–0.269 (5.8–6.8)
Operating force	10–14 oz (0.07–0.1 N)	7–12 oz (0.05–0.08 N)

Note: Shipping weight 0.25 lb (0.11 kg).

Type AP301, 303, 304, 305, 321, 323, 324, 325, and CP321, 323, 324, 325

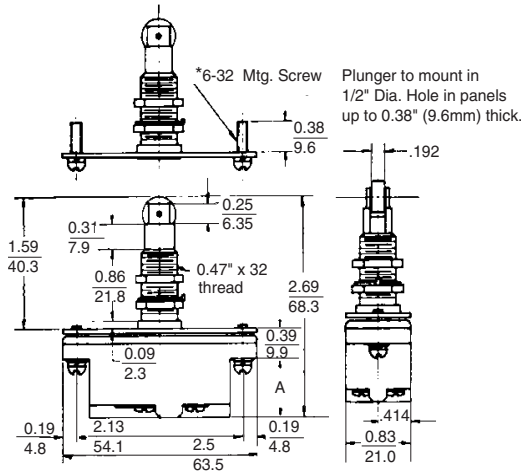

NOTE: Type AP321 shown.

Type	Dimension A
AP321, 323, 324, 325	0.70 (17.8)
CP321, 323, 324, 325	0.80 (20.3)

Operating Data				
	AP321, 324	AP323, 325	CP321, 324	CP323, 325
Pretravel	0.060–0.150 (1.5–3.8)	0.060–0.150 (1.5–3.8)	0.060–0.150 (1.5–3.8)	0.060–0.150 (1.5–3.8)
Differential	0.035–0.046 (0.9–1.2)	0.035–0.046 (0.9–1.2)	0.025–0.046 (0.9–1.2)	0.035–0.046 (0.9–1.2)
Total travel	0.200–0.340 (5.1–8.6)	0.200–0.340 (5.1–8.6)	0.200–0.340 (5.1–8.6)	0.200–0.340 (5.1–8.6)
Operating force	20 oz (0.14 N)	28 oz (0.2 N)	26 oz (0.18 N)	28 oz (0.2 N)

Limit Switches

Snap Action Industrial Switches

Class 9007

Approximate Dimensions and Operating Data, Types AB, CB, AC, and CC

Types AB21 through 24 and CB31 through 34

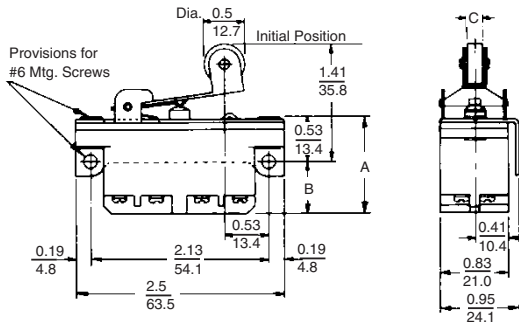

Note: Type CB31 RH mounting shown.
Type AB41 and CB41 same as above except without side mounting plates.

Type	Dimension		
	A	B	C
AB21, 22	1.03 (26.2)	0.5 (12.7)	0.22 (5.6)
AB23, 24	1.03 (26.2)	0.5 (12.7)	0.47 (12.0)
AB41	1.03 (26.2)	—	0.22 (5.6)
CB31, 32	1.13 (28.7)	0.59 (15.0)	0.22 (5.6)
CB33, 34	1.13 (28.7)	0.59 (15.0)	0.47 (12.0)
CB41	1.13 (28.7)	—	0.22 (5.6)

Operating Data

Pre-travel	0.16 (4.5)
Differential	0.08 (2.0)
Overtravel	0.06 (1.5)
Total travel	0.22 (5.6)
Operating force	8 oz (0.23 kg)

Note: Shipping weight 0.25 lb (0.11 kg).

Types AB25, 26 and CB35, 36

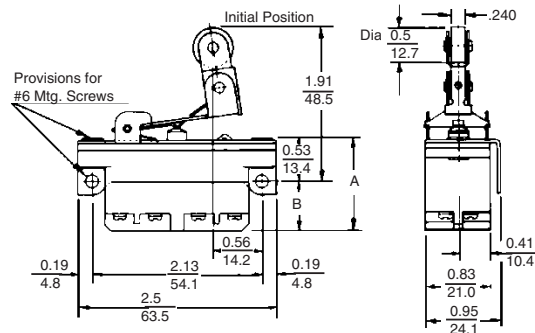

Note: Type CB35 mounting shown.

Type	Dimension		
	A	B	C
AB25, 26	1.03 (26.2)	0.5 (12.7)	0.22 (5.6)
CB35, 36	1.13 (28.7)	0.59 (15.0)	0.22 (5.6)

Operating Data

Pre-travel	0.16 (4.5)
Differential	0.08 (2.0)
Overtravel	0.06 (1.5)
Total travel	0.22 (5.6)
Operating force	8 oz (0.23 kg)

Types AC1 and CC1

Dimensions

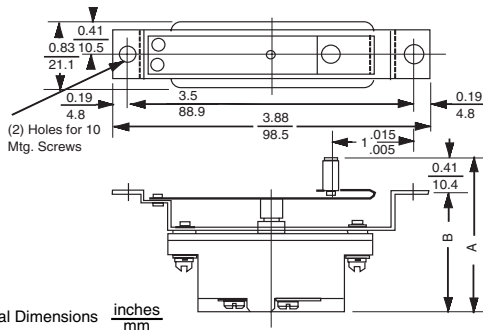

Note: Type AC1 shown.

Type	Dimension	
	A	B
AC1	1.91 (48.5)	1.5 (38.1)
CC1	2 (50.8)	1.59 (40.4)

Note: Shipping weight 0.25 lb (0.11 kg).

Operating Data

	AC1	CC1
Pre-travel	0.16 (4.5)	0.16 (4.5)
Differential	0.05 (1.3)	0.07 (1.8)
Overtravel	0.09 (2.3)	0.09 (2.3)
Total travel	0.25 (6.4)	0.25 (6.4)
Operating force	8 oz (0.23 kg)	8 oz (0.23 kg)

Limit Switches

Miniature

Class 9007 Type MS and ML



Shown with Standard Bottom Entrance Cable



Shown with 4-Pin Micro-Connector

Description

Mini-Switch (MS) miniature switches meet the need for very small, enclosed switches with environmental sealing. A full range of styles are available, including top push plunger, parallel roller plunger, cross roller plunger, rotary lever, and omnidirectional whisker. Factory pre-wiring with industrial grade cable (type SJTO) eliminates the need to remove the cover to wire the switch. Bottom- or side-entrance cable connection is available.

Housings are rugged diecast zinc construction. Excellent sealing is achieved with an epoxy compound encapsulation of the electrical cable connections and switch housing. A Viton® O-ring seal on the plunger keeps liquids from entering the switch cavity.

Features

The heavy-duty, completely encapsulated miniature MS limit switch is intended for difficult applications such as machine tools, earth moving equipment, and general transportation. Key features include:

- Symmetrical design and top mounting holes for easy gang mounting of several switches for multiple switching
- Epoxy encapsulation sealing the pre-wired heavy duty #18 AWG SJTO cable and protecting against temporary submersion
- Single-pole double-throw (SPDT) Form C or Form Z, 1 N.O. + 1 N.C. contact
- Fine rotary lever adjustment
- Compact diecast zinc housing
- NEMA Type 6P and IP67 rated
- 10 ampere continuous current rating
- Gold contacts for low level logic switching
- Stainless steel rollers
- UL Listed and CSA Certified
- CE Marking
- Standard temperature range: -40 to +220 °F (-40 to +104 °C)

Options

- Gold crosspoint contacts
- Double-break contacts (Type ML only)
- Side-entrance cable or connectors
- Low force (top plunger models only)
- Yellow or gray SJTO cable
- 4- or 5-pin micro-connectors, AC and DC
- #16 AWG SJTO cable
- Tapped 8-32 holes on top of housing

Rotary Head

Conventional rotary limit switches have mounting holes in the base or body of the switch. In our rotary design, mounting holes are located in the head also. Cycling and stress forces are transmitted from the shaft in the head directly to the mounting bolts. The strain on the joint between the body and the head is eliminated. The result is a stronger and more rigid mounting, less subject to vibration or a weakness in the joint.

Bulkhead Mounted Mini-Switches

The MS housing is designed for multiple switching by gang mounting several switches.

Two mounting holes can be tapped in the top of each switch (except rotary lever) for #8-32 thread bolts. Switches can be readily mounted to any frame or plate by drilling holes through same to accommodate #8-32 bolts and switch plungers. Both sides of the housing are counter-bored for surface mounting.



File E42259
CCN NKCR



File LR 25490
Class 3211 03



Marking

Limit Switches

Miniature

Class 9007 Types MS and ML

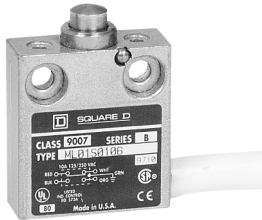

Shown with Side-Entrance Cable

- 0.98 in. (25 mm) Mounting Hole Centers
- 3 ft (0.9 m) Cable, Standard
- For other available lengths, and for a list of options, see page 158.

General Specifications	
Temperature range	-40 to +220 °F (-40 to +104 °C) The minimum temperatures listed are based on the absence of freezing moisture or water.
Enclosure rating	NEMA Types 1, 2, 4, 6, 6P, 12, 13, IP67
Vibration resistance	10G (75–1200 Hz)
Shock resistance	35G
Cable	#18 AWG SJTO

Contact Characteristics	
Rated thermal current	10 A (standard)
Rated insulation voltage	300 Vac and Vdc (standard)
Gold contact switching ratings	0.1 A, 24 Vdc; 0.24 VA

Type MS Circuit—Form C	Electrical Ratings/SPDT		
	Silver Contacts		Gold Contacts
1 N.O.—1 N.C.	Voltage	Make	Break
	120 AC	60 A	6 A
	240 AC	30 A	3 A
10.0 Amperes Continuous			100 mA @ 125 Vac 30 mA 28 Vdc
DC Contact Rating: 5 A (Resistance), 28 Vdc			

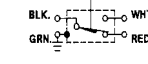

Type ML Circuit—Form Z	Electrical Rating/SPDT-DB		
	Silver Contacts		Gold Contacts
1 N.O.—1 N.C.	Voltage	Make	Break
	120 AC	60 A	6 A
	240 AC	30 A	3 A
10.0 Amperes, Continuous			100 mA @ 125 Vac 30 mA 28 Vdc
DC Contact Rating: 5 A (Res), 28 Vdc			

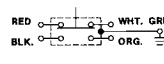

Description / Functional Diagrams

Top Plunger							
MS	ML	MS	ML	MS	ML	MS	ML
		Top plunger		Bushing mounted—top plunger		Adjustable top plunger	
Operating Force/Torque		80 oz (0.6 N)					
Contact		SPDT					
Form		Form C	Form Z	Form C	Form Z	Form C	Form Z
Contact Type		Silver MS01S0100	ML01S0100	MS06S0100	ML06S0100	MS09S0100	ML09S0100
		Gold MS01G0100	—	MS06G0100	—	MS09G0100	—

Parallel roller plunger							
MS	ML	MS	ML	MS	ML	MS	ML
		Parallel roller plunger		Bushing mounted—parallel roller plunger			
Operating Force/Torque		80 oz (0.6 N)					
Contact		SPDT					
Form		Form C	Form Z	Form C	Form Z	Form C	Form Z
Contact Type		Silver MS02S0100	ML02S0100	MS07S0100	ML07S0100	MS09S0100	ML09S0100
		Gold MS02G0100	—	MS07G0100	—	MS09G0100	—

Cross roller plunger							
MS	ML	MS	ML	MS	ML	MS	ML
		Cross roller plunger		Bushing mounted—cross roller plunger			
Operating Force/Torque		80 oz (0.6 N)					
Contact		SPDT					
Form		Form C	Form Z	Form C	Form Z	Form C	Form Z
Contact Type		Silver MS03S0100	ML03S0100	MS08S0100	ML08S0100	MS09S0100	ML09S0100
		Gold MS03G0100	—	MS08G0100	—	MS09G0100	—

Rotary lever, CW and CCW							
MS	ML	MS	ML	Omnidirectional—wire whisker (NEMA Types 1, 2, 12, 13 only)			
				Note: Lever not included.			
Operating Force/Torque		48 oz-in (0.3 N•m)		15 oz-in (0.1 N•m)			
Contact		SPDT					
Form		Form C	Form Z	Form C			
Contact Type		Silver MS04S0100	ML04S0100	MS05S0100			
		Gold MS04G0100	—	MS05G0100			

Limit Switches

Limit Switches

Miniature

Class 9007 Type MS and ML

Description / Functional Diagram

Booted Devices										
MS		ML		MS	ML	MS	ML			
Operating Force/Torque				80 oz (0.6 N)						
Contact				SPDT						
Form				Form C	Form Z	Form C	Form Z			
Contact Type				Silver	MS10S0100	ML10S0100	MS12S0100	ML12S0100	MS13S0100	ML13S0100
				Gold	MS10G0100	—	MS12G0100	—	MS13G0100	—

Note: See the available options on page 158 and add the designator (up to three) to the end of the catalog number, if applicable. See the example on page 158 for conductor length selection.

Lever Arm Selection

There are many styles of levers to accommodate most industrial applications. The levers are diecast metal. The standard roller levers are available with nylon rollers and are also available with steel rollers. See the tables below. Dimensions are given as in. (mm).

Style 7 Levers—0.75 in. (19 mm) diameter, nylon or steel roller

Length		Catalog Number 0.25 (6) Wide		Catalog Number 0.5 (13) Wide		Catalog Number 0.75 (19) Wide		Catalog Number 1 (25) Wide	
in.	mm	Nylon	Steel	Nylon	Steel	Nylon	Steel	Nylon	Steel
0.875	22.23	7A2N	7A2	7B2N	7B2	7F2N	—	7J2N	—
1.375	34.93	7A3N	—	7B3N	—	7F3N	—	7J3N	—
1.5	38.10	7A1N	7A1	7B1N	—	7F1N	—	7J1N	—
1.75	44.45	7A7N	—	7B7N	—	7F7N	—	7J7N	—
2.00	50.8	7A4N	—	7B4N	—	7F4N	—	7J4N	—



Lever

Style 7X Levers—0.75 in. (19 mm) diameter, nylon or steel roller

Length		Catalog Number 0.25 (6) Wide		Catalog Number 0.5 (13) Wide		Catalog Number 0.75 (19) Wide		Catalog Number 1 (25) Wide	
in.	(mm)	Nylon	Steel	Nylon	Steel	Nylon	Steel	Nylon	Steel
.875	22.23	7XA2N	7XA2	7XB2N	7XB2	7XF2N	—	7XJ2N	—
1.375	34.93	7XA3N	—	7XB3N	—	7XF3N	—	7XJ3N	—
1.5	38.10	7XA1N	7XA1	7XB1N	—	7XF1N	—	7XJ1N	—
1.75	44.45	7XA7N	—	7XB7N	—	7XF7N	—	7XJ7N	—
2.00	50.8	7XA4N	—	7XB4N	—	7XF4N	—	7XJ4N	—

Specialty Arms and Options

Description	Length	Diameter	Width	Catalog Number
Style 7D adjustable length, metal roller	1.38 to 3.38 (35 to 85.8)	0.75 (19)	0.25 (6.35)	7D
Style 7D adjustable length, nylon roller	1.38 to 3.38 (35 to 85.8)	0.75 (19)	0.25 (6.35)	7DN
Style 7S spring nylon rod	6 (152.4)	0.3 (7.6)	—	7S
Style 7N nylon rod	5 (127)	0.3 (7.6)	—	7N
Corrosion proof (option available with nylon rollers only)—Suffix to add to the end of catalog number				S

Lever tightening torque for mounting the lever on the shaft: minimum 17 lb-in (1.9 N•m).

Limit Switches

Miniature

Class 9007 Type MS and ML

Catalog Number Interpretation and Options

For Interpretation of the Catalog Number Only

9007 M S 0 1 S 0 1 0 0



9007MS02 Shown with M12 Connector

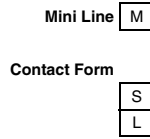

Actuator Type

Top Push Plunger	0 1
Parallel Roller Plunger	0 2
Cross Roller Plunger	0 3
Rotary Lever CW & CCW	0 4
Omnidirectional Wire Whisker	0 5
Bushing Mounted Top Push Plunger	0 6
Bushing Mounted Parallel Roller Plunger	0 7
Bushing Mounted Cross Roller Plunger	0 8
Adjustable Top Push Plunger	0 9
Booted Top Push Plunger	1 0
Booted Parallel Roller Plunger	1 2
Booted Cross Roller Plunger	1 3

Conductor Length Options

0 0	No Cable
0 1	3 ft (0.9 m) (stranded)
0 2	6 ft (1.8 m)
0 3	9 ft (2.7 m)
0 4	12 ft (3.7 m)
0 5	18 ft (5.5 m)
1 3	33 ft (10 m)

Contact Type

S	10 A Silver Contacts (standard)
G	Gold Contacts

Examples

Option	Description
0 2	# 16 AWG SJTO Cable
0 6	Side Entrance 18-4 SJTO Cable
1 0	Gray 18-4 SJTO Cable
1 1	# 18 AWG Individual Conductors
2 1	Low Force (top plunger only) 18 oz.

◆ List options in numerically ascending order. Example: 9007MS01S030621. See other options below.

Conductor Length	Designator
No cable	00
3 ft (0.9 m)—standard	01
6 ft (1.8 m)	02
9 ft (2.7 m)	03
12 ft (3.7 m)	04
18 ft (5.5 m)	05
33 ft (10 m)	13

MS Options (Does not apply to ML except where noted)	Designator
#16 AWG SJTO cable	02
Side entrance, #18 AWG SJTO cable, or Connector 12, 54, 55, 82, 84 *	06
Gray #18 AWG SJTO cable	10
#18 AWG individual conductors	11
Male 4-pin mini-connector with 3 ft (0.9 m) cable (MS only)	12
Low force (NEMA Type 1 only) 18 oz.	21
High Pre-Travel—adds 0.030	30
Male 4-pin micro-connector in housing (DC type) † (no cable) (MS only)	54
Male 5-pin micro-connector in housing (DC type) † (no cable) (ML only)	55
Tapped holes in top of plunger style housing (MS and ML)	81
Male 4-pin micro-connector in housing (AC type) (no cable) (MS only)	82
Black 18/5 SJTO Cable (ML only)	83
Male 4-pin micro-connector in housing (AC type) (no cable) (MS only)	84

■ Ex: 9007MS01S0100 with a 9 ft (2.7 m) cable becomes 9007MS01S0300. 9007MS01S0100 with side entrance becomes 9007MS01S0106.

* For side entry connectors, include 06, then 12, 54, 55, 82, or 84; otherwise the connector will come from bottom of housing. Example of catalog no. with side entrance connector: 9007MS01S000654. No cable available with 54 and 55. Option 12 is supplied with 3 ft (0.9 m) of cable.

† DC connectors are rated 3 A, 250 Vac/Vdc.

Male Plug (face) Pin-outs

Option 54 (MS only)	Option 55 (ML only)	Option 12 (MS only)	Option 82 (MS only)	Option 84 (MS only)

Limit Switches

Miniature

Class 9007 Type MS and ML

Dimensions

Top Push Plunger

MS01, MLO1

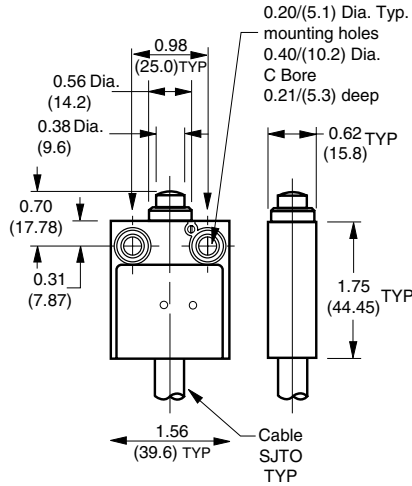

Rotary Lever

MSO4, MLO4

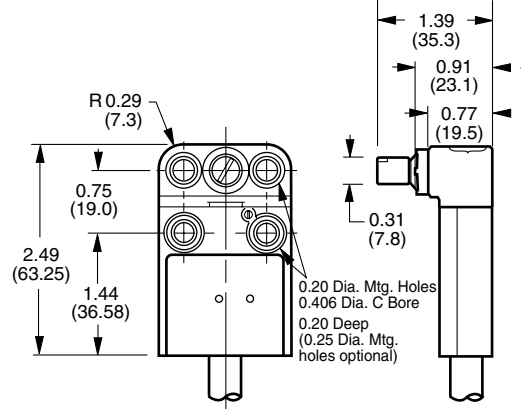

Booted Top Push Plunger with Mid-Side Entry Cable

MS10, ML10

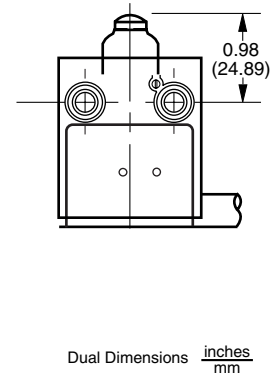

Parallel Roller Plunger

MS02, ML02

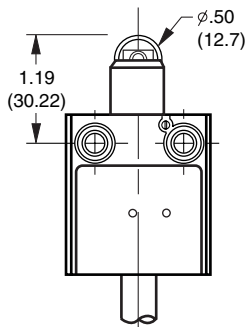

Cross Roller Plunger

MS03, ML03

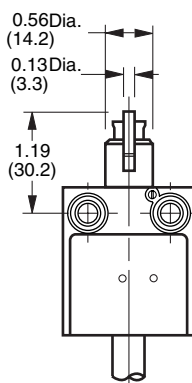

Adjustable Top Push Plunger

MS09, ML09

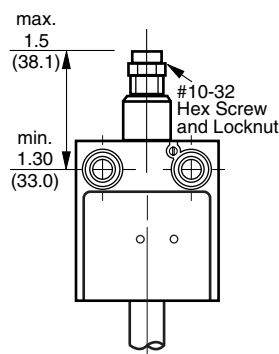

Omini-directional

MS05, ML05

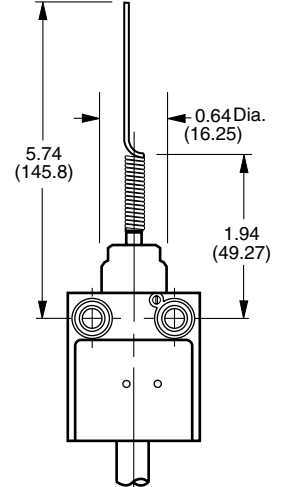

Bushing Mounted Top Push Plunger

MS06, ML06

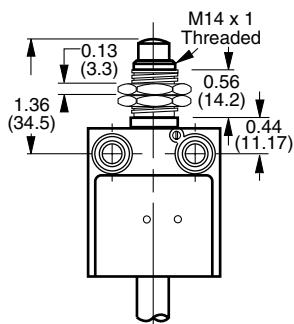

Bushing Mounted Parallel Roller Plunger

MS07, ML07

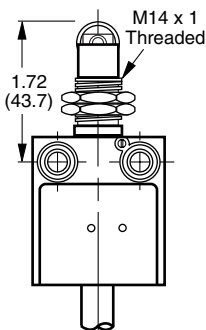

Parallel Booted Roller Plunger

MS12, ML12

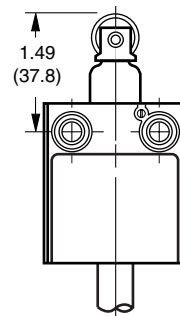

Cross-Booted Roller Plunger

MS13, ML13

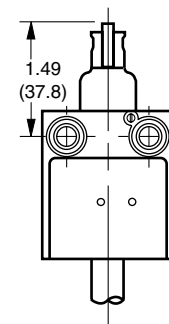

Limit Switches

Limit Switches

Miniature Enclosed Reed

Class 9007 Type XA



Straight Plunger



Roller Plunger



Cross Roller Plunger

Description and Specifications

Sealed construction keeps contaminants out of the contact area, making it the ideal choice for low voltage, low current circuits used by programmable controllers.

Type XA is designed for use in applications where contact reliability, environmental immunity, small size, or low cost are required.

NOTE:

- Because reed switches are operated by a magnet, they should not be installed in areas where strong magnetic fields may be present. The devices should always be checked for proper operation after installation.
- Type XA **cannot be used in Division 2 locations** since the National Electrical Code (NEC) requires provisions for conduit connection. The Type C reed switches have this provision for conduit but the Type XA do not.

Cable Length* ft (m)	Straight Plunger		Roller Plunger		Cross Roller Plunger	
	N.O. Type	N.C. Type	N.O. Type	N.C. Type	N.O. Type	N.C. Type
3 (0.9)	XA7303E	XA7503E	XA7303D	XA7503D	XA7303DC	XA7503DC
6 (1.8)	XA7306E	XA7506E	XA7306D	XA7506D	XA7306DC	XA7506DC
9 (2.7)	XA7309E	XA7509E	XA7309D	XA7509D	XA7309DC	XA7509DC

* Other cable lengths are available. Order by changing the last two numerical digits of the Type number to the length desired.
Example: An XA7303E with 15 ft (4.5 m) of cable would become an XA7315E.

Operating Data

Dimensions in. (mm)	Top Push Rod (Type E)	Roller Plunger (Types D, DC)
Initial position (D)	0.690 (17.5)	1.190 (30.2)
Trip position (B)	0.620 (15.7)	1.120 (28.4)
Pre-travel (E)	0.07 (1.8)	0.07 (17.8)
Reset position (C) maximum	0.655 (16.6)	1.155 (29.3)
Differential (F)	0.015 (0.38)	0.015 (0.38)
Final position (A)	0.492 (12.5)	0.992 (25.2)
Total stroke	0.198 (5.0)	0.198 (5.0)
Operating force (max.)	2.75 lb (0.31 N)	2.75 lb (0.31 N)

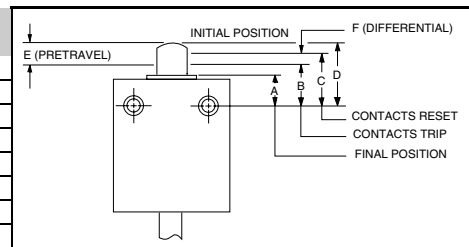

Contacts	The contact is a fully encapsulated, hermetically sealed reed, suitable for controlling solid-state loads as well as industrial relays. Switches can also be used as inputs to intrinsically safe systems. Use of a transient suppressor extends the life of the switch when used on heavy electrical loads.	
Enclosure Construction	Diecast zinc—baked, gray enamel finish. Meets NEMA Types 2, 4, 4X, 6P, 12 and 13 requirements. Oil-tight, dust-tight, water-tight, and submersible.	
Cable	SJTOWA jacketed cable with 18 gauge wire.	
Ambient Temperature	-20 to +140 °F (-28.9 to +60 °C).	
Agency Listings	UL: File E42259 CCN NKCR	CSA: File LR 25490, Class 3211 03

NOTE: The XA switch is available with a 3 ft (0.9 m) cable and 3-pin Brad Harrison male connector No. 40904 (or equivalent), Form Y190.

Maximum Current Ratings for Control Circuit Contacts—Type XA

AC—50/60 Hz						DC		
Volts	Inductive (35% Power Factor)			Continuous Carrying Amperes	Resistive (75% Power Factor) Make, Break, and Continuous Carrying Amperes	Volts	Resistive	
	Make		Break				Make and Break Amperes Single Throw	Continuous Carrying Amperes
	A	VA	A	VA				
120	2.0	240	0.2	24	0.5	120	0.2	0.5
240	1.0	240	0.1	24	0.5	—	—	—

Contact Diagrams

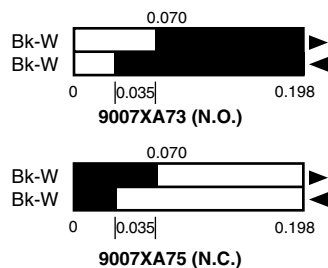

Dimensions

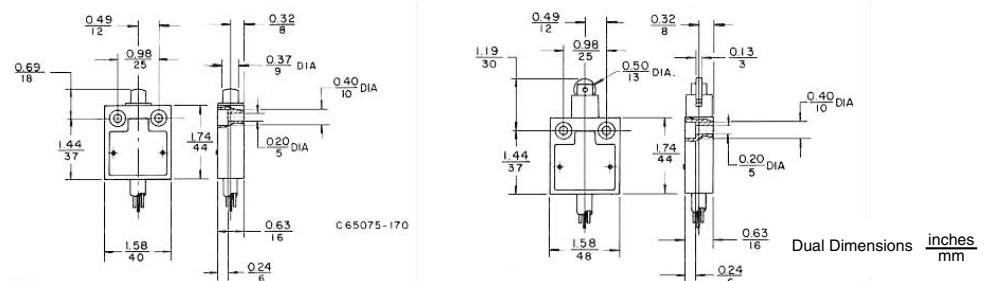

Limit Switches

9007AW Heavy Duty Industrial Precision, Oiltight



Lever Arm Type



Plunger Type

Dual Dimensions $\frac{\text{inches}}{\text{mm}}$

Lever Arm And Plunger Types

Select Switch		Lever Arm Type Without Lever Arm. Select from CCW Operation ■	Select Operator	
Mounting	Contacts	Type	Roller Plunger Type With Micrometer Adjustment	Push Rod Plunger Type With Micrometer Adjustment
Surface Mounting Plug-in	1 N.O.—1 N.C.	AW16	AW36	AW46
	2 N.O.	‡	—	—
	2 N.C.	AW19‡	—	—
Surface Mounting Nonplug-in Standard Box	1 N.O.—1 N.C.	AW12	AW32	AW42
Surface Mounting Nonplug-in Deep Box	1 N.O.—1 N.C.	AW14	—	—
	2 N.O.—2 N.C.	AW18	AW38	—
Open Type (Without Box) Plug-in	1 N.O.—1 N.C.	AO16	AO36	—
	2 N.O.	‡	—	—
	2 N.C.	‡	—	—
Open Type (Without Box) Nonplug-in	1 N.O.—1 N.C.	AO12	—	—
	2 N.O.—2 N.C.	AO18	—	—
Flush Mounting	1 N.O.—1 N.C.	AF12	—	—

Nominal Operating Data in. (mm)	Pre-travel	5°	0.09 (2.3)	0.09 (2.3)
	Total-travel	30°	0.25 (6.3) ±0.06 (1.5) Adjustable	0.25 (6.3) ±0.06 (1.5) Adjustable
	Differential	2.5°	0.05 (1.3)	0.05 (1.3)
	Reverse Over-travel	25°	—	—
	Operating Torque or Force	2.75 lb-in (0.31 N•m)	3 lb-in (0.34 N•m)	3 lb-in (0.34 N•m)
	Repeat Accuracy	±0.002 (0.05) Linear travel of cam on 1.38 (35) lever arm	±0.001 (0.02)	±0.001 (0.02)

■ Field convertible to CW operation.

‡ 2 N.O. contact only when Type AW19 is operated in clockwise direction. 2 N.C. contacts only when Type AW19 is operated in counterclockwise direction.

Lever arms, see page 190.

Approximate Dimensions

Type AW

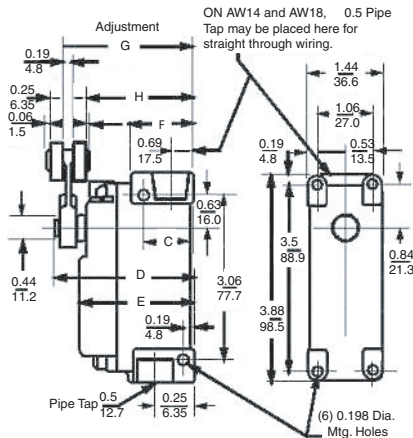

Type AO

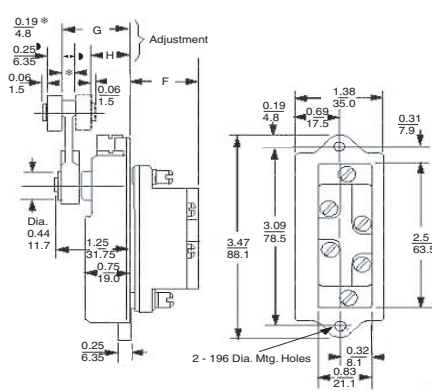

Type AW42, 46, 48, and 49

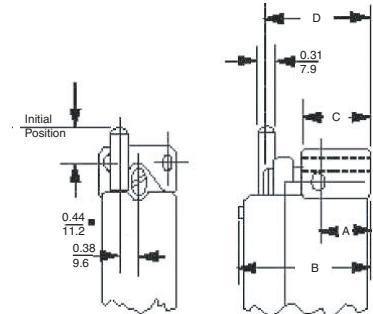

Type AW32, 36, and 38

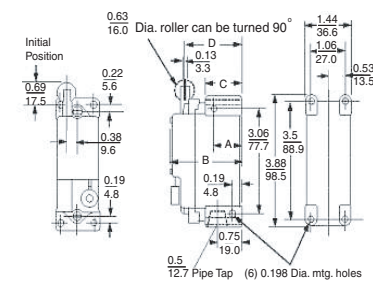

Type	C	D	E	F	G	H
AW12	0.31 (7.9)	2.69 (68.3)	2.19 (56)	1.16 (29.4)	2.5–2.56 (63.5–65)	2.06–2.13 (52.3–54)
AW14						
AW16	1.25 (32)	3 (76)	2.5 (63.5)	1.47 (37)	2.81–2.88 (71–73)	2.38–2.44 (60–62)
AW18						
AW19						
AO12	—	—	—	1.03 (26)	1.06–1.13 (27–29)	0.63–0.69 (16–17.5)
AO18	—	—	—	1.13 (29)	1.06–1.13 (27–29)	0.63–0.69 (16–17.5)

Type	A	B	C	D
AW32 and AW42	0.31 (7.9)	2.22 (56)	1.16 (29.4)	1.81 (46)
AW36, 38, 46, 48, and 49	1.25 (32)	2.53 (64)	1.47 (37.3)	2.13 (5.4)

Limit Switches

Limit Switches

9007C Heavy Duty Industrial—Plug-in Body, Metal Standard and Compact

Standard plug-in body type with 1 cable entry (1)

The standard plug-in body types with one cable entry are also available with reed contacts

With reed contacts

With head for linear movement side plunger

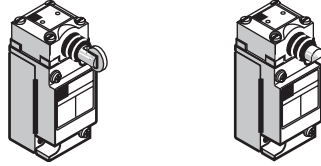

Page 164
Page 168

top plunger

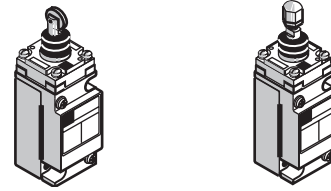

Page 165
Page 173

With head for rotary movement (lever)

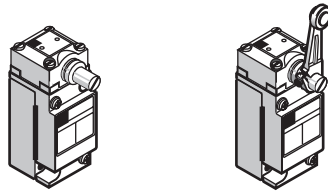

Page 166
Page 170

With head for multi-directional movement

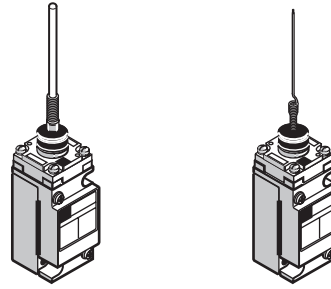

Page 167
Page 171

With reed contacts

Compact plug-in body type with one cable entry (1)

With head for linear movement Side plunger

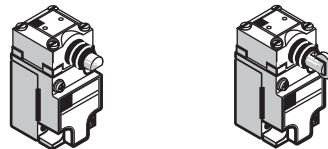

Page 172

Top plunger

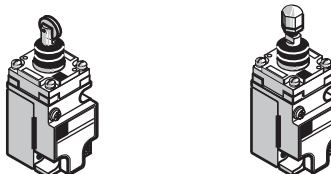

Page 173

With head for rotary movement (lever)

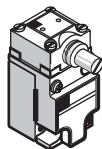

Page 174

With head for multi-directional movement

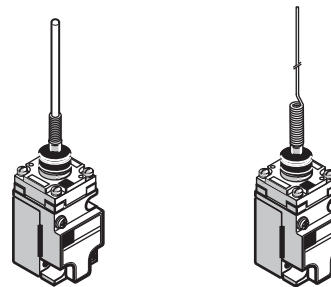

Page 175

1. Factory modifications: see pages 176 to 180

Limit Switches

9007C Heavy Duty Industrial—Plug-in Body, Metal Standard and Compact

Environmental characteristics		
Conforming to standards	Products	NEMA 250, EN 60947-1, EN 60947-5-1, IEC 60947, UL 508, C22-2-14-95, CE conformity documentation
Product certifications		UL, CSA, CE
Protective treatment		Epoxy powder coat (additional protection available)
Ambient air temperature	Operation	-20...+185 °F (-28.9...+85 °C), wider range available
	Storage	-20...+185 °F (-28.9...+85 °C), wider range available
Vibration resistance	Conforming to IEC 60068-2-6	25 gn (10...150 Hz, 11 ms) (Reed switch good for 18.5g only)
Shock resistance	Conforming to IEC 60068-2-27	60 gn (9 ms) 40 gn (9 ms) for reed switch
Electric shock protection	Conforming to IEC 61140	Class 0
Degree of protection	Conforming to IEC 60529	IP 67
Cable entry or connector (1)	Depending on model	1/2-14 NPT, M20 x 1.5, ISO cable entry, 5-pin mini connector, 4-pin micro connector
Materials	Bodies, heads, levers	Bodies and heads in Zamak® zinc alloy, levers and rods in zinc, steel, stainless steel, Delrin® resin.

1. A wide range of connectors are available. Contact your local field office.

Contact block characteristics		
Rated operational characteristics hard contacts -AC Voltage (top half of body)	9007CO52 (compact single)	NEMA A600 (Ue = 600 V, Ie = 1.2 A); Ithe = 10 A
	9007CO54 (single pole)	NEMA A600 (Ue = 600 V, Ie = 1.2 A); Ithe = 10 A
	9007CO62 (two pole)	NEMA A600 (Ue = 600 V, Ie = 1.2 A); Ithe = 10 A
	9007CO66 (two pole two stage)	NEMA A600 (Ue = 600 V, Ie = 1.2 A); Ithe = 10 A
	9007CO68 (two pole neutral)	NEMA A600 (Ue = 600 V, Ie = 1.2 A); Ithe = 10 A
Reed switches, complete body	9007C84 (1 N.O.)	NEMA C600 (Ue = 600 V, Ie = 0.3 A); Ithe = 2.5 A
	9007C86 (1 N.C.)	NEMA C600 (Ue = 600 V, Ie = 0.3 A); Ithe = 2.5 A
Rated operational characteristics hard contacts -DC Voltage (top half of body)	9007CO52 (compact single)	NEMA Q600 (Ue = 600 V, Ie = 0.1 A); Ithe = 2.5 A
	9007CO54 (single pole)	NEMA Q600 (Ue = 600 V, Ie = 0.1 A); Ithe = 2.5 A
	9007CO62 (two pole)	NEMA R300 (Ue = 250 V, Ie = 0.11 A); Ithe = 1.0 A
	9007CO66 (two pole two stage)	NEMA R300 (Ue = 250 V, Ie = 0.11 A); Ithe = 1.0 A
	9007CO68 (two pole neutral)	NEMA R300 (Ue = 250 V, Ie = 0.11 A); Ithe = 1.0 A
Reed switches, complete body	9007C84 (1 N.O.)	NEMA Q150 (Ue = 125 V, Ie = 0.55 A); Ithe = 2.5 A
	9007C86 (1 N.C.)	NEMA Q150 (Ue = 125 V, Ie = 0.55 A); Ithe = 2.5 A
Rated insulation voltage		600 V
Rated impulse withstand voltage		2,500 Vac for 1 minute for CE; 2,200 Vac for 1 minute for UL; and 2,640 Vac for 1 s for CSA
Positive opening	Special Y1561	Special Y1561 (one pole slow break only) →
Short circuit protection		10 A, Bussman Class CC KTK-R-10 fuse non-time-delay
Terminal wire sizes (cabling/screw clamp)		1 or 2, 12–22 AWG (2.05–0.644 mm ²) wires maximum
Maximum actuation speed		15.2 mpm / 27.4 mpm (50 fpm / 90 fpm) with 45 degree cam angle, levers only
Electrical durability		1 million operating cycles



Types of contact elements

Example: 9007C54 single-pole limit switch, Form Z, same polarity

IEC 60947-5-1			NEMA			JIS		
Form	Symbol	Description	Form	Symbol	Description	Form	Symbol	Description
A		Single break	A		—	3		—
X		—						Double break
B		Single break	B		—	2		—
Y		—						Double break
C		—	C		—	1		Single break
Za		Same polarity	Z		"Same polarity" only			Double break
Zb		Electrically separate						—

Limit Switches

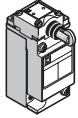
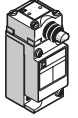
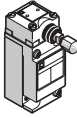
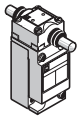
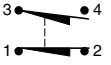
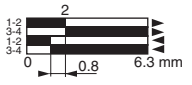
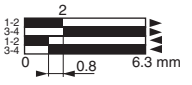
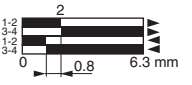
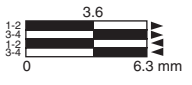
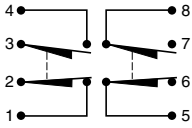
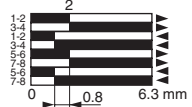
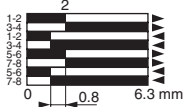
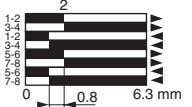
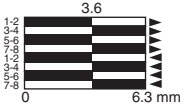
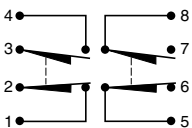
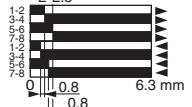
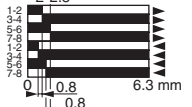
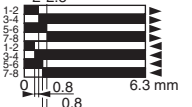
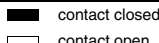
9007C Heavy Duty Industrial—Plug-in Body, Metal Standard Body





Type of head		Side Plunger (mounting by the body)			
Standard plug-in body type					
Type of operator		Side roller plunger, spring return, vertical roller (1)	Side push rod plunger, spring return	Side push rod plunger, adjustable (2) spring return	Side push rod plunger, maintained contact
Catalog numbers					
1 N.O. 1 N.C. snap action 		9007C54F 	9007C54G 	9007C54GD 	9007C54H 
2 N.O. 2 N.C. snap action 		9007C62F 	9007C62G 	9007C62GD 	9007C62H 
2 N.O. 2 N.C. Two stage snap action 		9007C66F 	9007C66G 	9007C66GD 	
Weight, kg (lb)		0.568 (1.25)	0.568 (1.25)	0.568 (1.25)	0.568 (1.25)
Contact operation					
Characteristics (nominal operating data)					
Switch actuation		On end			
Type of actuation					
Pre-travel		2 mm (0.08 in.)			3.6 mm (0.14 in.)
Pre-travel two Stage		First stage		2 mm (0.08 in.)	
		First stage to second stage		0.5 mm (0.02 in.)	
Total travel		6.3 mm (0.25 in.)			
Differential		0.8 mm (0.03 in.)			
Reverse overtravel		—			
Minimum force or torque		1 pole & 2 pole 4 lb (17.8 N)			7 lb (31.1 N)
Terminal wire sizes (Cabling/Screw Clamp)		1 or 2, 12–22AWG (2.05–0.644 mm ²) wires maximum			
Repeatability (linear travel of cam)		0.03 mm (0.001 in.)			—
Cable entry		1/2-14 NPT standard, optional M20 x 1.5 mm for ISO cable entry			

1. Can be converted to horizontal roller type in the field. To order horizontal roller version add the letter **H** at the end of the equivalent vertical roller version type.
2. To lock the nut in the desired position, crimp the slot near the bottom of the nut.

Dimensions:
pages 182 to 185

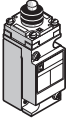
Limit Switches

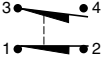
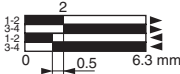
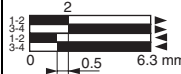
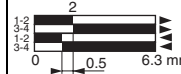
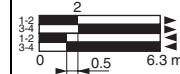
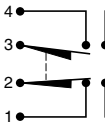
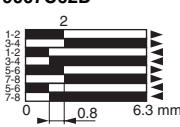
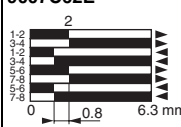
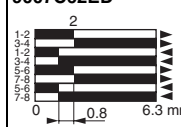
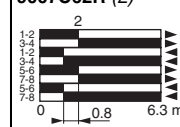
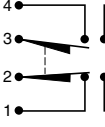
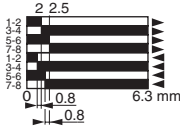
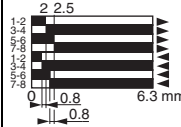
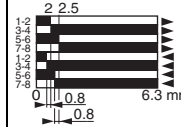
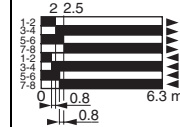
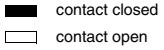
9007C Heavy Duty Industrial—Plug-in Body, Metal Standard Body

Type of head		Top Plunger (mounting by the body)			
Standard plug-in body type					
Type of operator		Top roller plunger spring return	Top push rod plunger spring return	Top push rod plunger adjustable (1) spring return	Palm operated (2)
Catalog numbers					
1 N.O. 1 N.C. snap action 		9007C54D 	9007C54E 	9007C54ED 	9007C54R (2) 
2 N.O. 2 N.C. snap action 		9007C62D 	9007C62E 	9007C62ED 	9007C62R (2) 
2 N.O. 2 N.C. Two stage snap action 		9007C66D 	9007C66E 	9007C66ED 	9007C66R (2) 
Weight, kg (lb)		0.568 (1.25)	0.568 (1.25)	0.568 (1.25)	0.568 (1.25)
Contact operation					
Characteristics (nominal operating data)					
Switch actuation		On end			
Type of actuation					
Pre-travel		2 mm (0.08 in.)			
Pre-travel two Stage		First stage: 2 mm (0.08 in.) First stage to second stage: 0.3 mm (0.01 in.)			
Total travel		6.3 mm (0.25 in.)			
Differential		0.5 mm (0.02 in.)			
Reverse overtravel		—			
Minimum force or torque		1 pole & 2 pole: 3 lb (13.3 N)			7 lb (31.1 N)
Terminal wire sizes (Cabling/Screw Clamp)		1 or 2, 12–22 AWG (2.05–0.644 mm ²) wires maximum			
Repeatability (linear travel of cam)		0.03 mm (0.001 in.)			
Cable entry		1/2-14 NPT standard, optional M20 x 1.5 mm for ISO cable entry			

- To lock the nut in the desired position, crimp the slot near the bottom of the nut.
- Does not include mushroom button. Must be ordered separately see page 189.

Dimensions:
pages 182 to 185

Limit Switches

9007C Heavy Duty Industrial—Plug-in Body, Metal Standard Body

Type of head Rotary (lever arm type) (1)

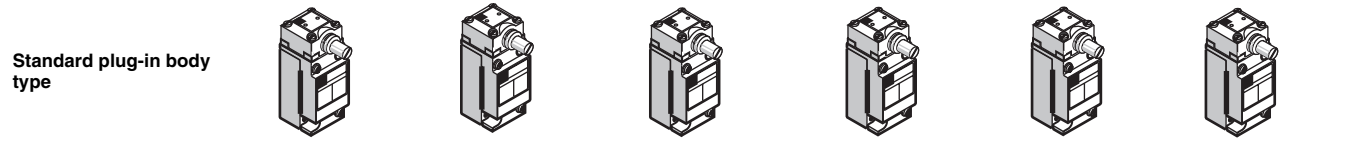

Type of operator	Standard pre-travel, spring return	Low differential, spring return	Neutral position		Light operating torque spring return	Maintained contact
Type of direction	CW & CCW (2)	CW & CCW (2)	CW & CCW	CW & CCW	CW & CCW (2)	CW (trip) CCW (reset)
1 N.O., 1 N.C. snap action	9007C54B2 	9007C54A2 			9007C54N2 	9007C54C
2 N.O., 2 N.C. snap action	9007C62B2 	9007C62A2 			9007C62N2 	9007C62C
2 N.O., 2 N.C. snap action Neutral position			9007C68T10 	9007C68T5 		
2 N.O., 2 N.C. Two stage snap action	9007C66B2 	9007C66A2 			9007C66N2 	
Weight, kg (lb)	0.568 (1.25)	0.568 (1.25)	0.568 (1.25)	0.568 (1.25)	0.568 (1.25)	0.568 (1.25)
Contact operation	contact closed		contact open			

Characteristics (nominal operating data)

Switch actuation	By 30° cam					
Type of actuation						
Pre-travel	10°	5°	10°	5°	10°	45°
Pre-travel two stage						
First stage	10°	5°	—	—	10°	—
First stage to second stage	2.5°	1.5°	—	—	2.5°	—
Total travel	90°	90°	90°	90°	90°	90°
Differential	4°	2°	4°	2°	4°	—
Reverse overtravel	90°	90°	90°	90°	90°	90°
Operating torque/force 1 pole & 2 pole	4 lb-in (0.45 N•m)				25 oz-in (0•18 N•m)	3 lb-in (0.34 N•m)
Terminal wire sizes (Cabling/Screw Clamp)	1 or 2, 12–22 AWG (2.05–0.644 mm ²) wires maximum					
Repeatability (linear travel of cam)	0.05 mm (± 0.002 in.)	0.03 mm (± 0.001 in.)	0.05 mm (± 0.002 in.)	0.05 mm (± 0.002 in.)	0.05 mm (± 0.002 in.)	0.05 mm (± 0.002 in.)
Cable entry	1/2-14 NPT standard, optional M20 x 1.5 mm for ISO cable entry					

- Lever arm type must be ordered separately from pages 190 to 195.
- These devices are factory set to operate the contacts in **both** the CW and CCW directions. **Mode of operation** is field convertible to CW only or CCW only. **To order factory converted devices:** For CCW only operation, change the 2 at the end of the Type number to 1 (for example, C54B2 becomes C54B1). For CW only operation, delete the 2 at the end of the Type number (for example C54B2 becomes C54B).

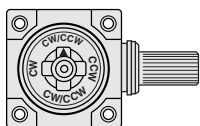









Mode of operation of the lever arm is easily convertible to clockwise or both. Simply pull out and rotate the arrow to the letters representing the desired direction—CW, CCW, or CW/CCW.

Dimensions:
pages 182 to 185

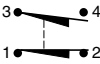
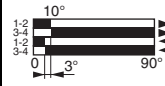
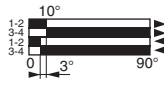
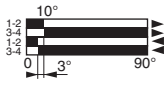
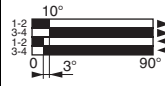
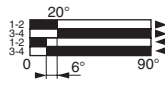
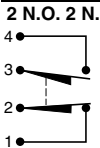
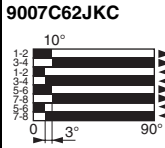
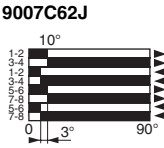
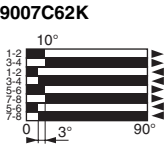
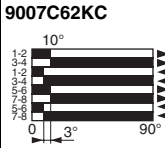
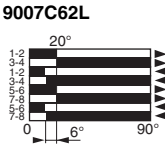
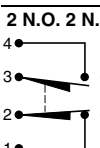
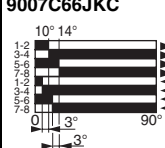
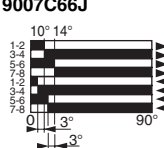
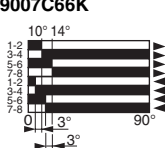
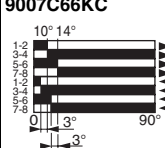
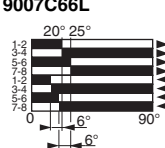
Limit Switches

9007C Heavy Duty Industrial—Plug-in Body, Metal Standard Body

Type of head	Flexible operator (wobble stick)				
Standard plug-in body type					
Type of operator	Universal (1)	Wobble stick Delrin® extension (1)	Wobble stick wire extension (1)	Wobble stick coil spring extension (1)	Cat whisker
Catalog numbers					
1 N.O. 1 N.C. snap action 	9007C54JKC 	9007C54J 	9007C54K 	9007C54KC 	9007C54L 
2 N.O. 2 N.C. snap action 	9007C62JKC 	9007C62J 	9007C62K 	9007C62KC 	9007C62L 
2 N.O. 2 N.C. Two stage snap action 	9007C66JKC 	9007C66J 	9007C66K 	9007C66KC 	9007C66L 
Weight, kg (lb)	0.568 (1.25)	0.568 (1.25)	0.568 (1.25)	0.568 (1.25)	0.568 (1.25)
Contact operation	 contact closed  contact open				
Characteristics (nominal operating data)					
Switch actuation	Object from any direction				
Type of actuation					
Pre-travel	10° (any direction)				20°
Pre-travel two stage	10° (any direction)				20°
First stage	10° (any direction)				20°
First stage to second stage	4°				5°
Total travel	90°				
Differential	3				6°
Reverse overtravel	—				
Operating torque/force 1 pole & 2 pole	3 lb-in (0.34 N•m)				7 oz-in (0.05 N•m)
Terminal wire sizes (Cabling/Screw Clamp)	1 or 2, 12–22 AWG (2.05–0.644 mm ²) wires maximum				
Repeatability (linear travel of cam)	—				
Cable entry	1/2-14 NPT standard, optional M20 x 1.5 mm for ISO cable entry				

1. Wobble stick extensions are available separately for the universal head. See page 189.

Dimensions:
pages 182 to 185

Limit Switches

9007C Heavy Duty Industrial—Plug-in Body, Metal Standard Body—Reed Contacts







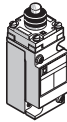
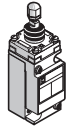
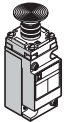

Type of head		Side Plunger (mounting by the body)			
Standard plug-in body type					
Type of operator		Side roller plunger spring return vertical roller (1)	Side push rod plunger spring return	Side push rod plunger adjustable (2) spring return	Side push rod plunger maintained contact
Catalog numbers					
1 N.O. Reed contacts snap action 		9007C84F 	9007C84G 	9007C84GD 	9007C84H
1 N.C. Reed contacts snap action 		9007C86F 	9007C86G 	9007C86GD 	9007C86H
Weight, kg (lb)		0.568 (1.25)	0.568 (1.25)	0.568 (1.25)	0.568 (1.25)
Contact operation		contact closed contact open			
Characteristics (nominal operating data)					
Switch actuation		On end			
Type of actuation					
Pre-travel		2.8 mm (0.110 in.)			3.6 mm (0.14 in.)
Total travel		6.3 mm (0.25 in.)			
Differential		1.8 mm (0.07 in.)			—
Reverse overtravel		—			—
Minimum force or torque 1 pole & 2 pole		4 lb (17.8 N)			7 lb (31.1 N)
Terminal wire sizes (Cabling/Screw Clamp)		1 or 2, 12–22 AWG (2.05–0.644 mm ²) wires maximum			
Repeatability (linear travel of cam)		0.076 mm (± 0.003 in.)			—
Cable entry		1/2-14 NPT standard, optional M20 x 1.5 mm for ISO cable entry			

- Can be converted to horizontal roller type in the field. To order horizontal roller version add the letter **H** at the end of the equivalent vertical roller version type.
- To lock the nut in the desired position, crimp the slot near the bottom of the nut.

Dimensions:
pages 182 to 185

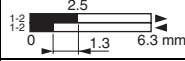
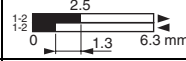
Limit Switches

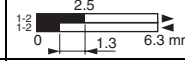
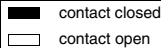
9007C Heavy Duty Industrial—Plug-in Body, Metal Standard Body—Reed Contacts

Type of head	Top Plunger (mounting by the body)			
Standard plug-in body type				
Type of operator	Top roller plunger spring return	Top push rod plunger spring return	Top push rod plunger adjustable (1) spring return	Palm operated (2)
Catalog numbers				
1 N.O. Reed contacts snap action 3 ● ● ● ● 4	9007C84D 	9007C84E 	9007C84ED 	9007C84R (2) 
1 N.C. Reed contacts snap action 1 ● ● ● ● 2	9007C86D 	9007C86E 	9007C86ED 	9007C86R (2) 
Weight, kg (lb)	0.568 (1.25)	0.568 (1.25)	0.568 (1.25)	0.568 (1.25)
Contact operation				
Characteristics (nominal operating data)				
Switch actuation	On end			
Type of actuation				
Pre-travel	2.5 mm (0.100 in.)			
Total travel	6.3 mm (0.25 in.)			
Differential	1.3 mm (0.05 in.)			
Reverse overtravel	—			
Minimum force or torque 1 pole & 2 pole	4 lb (17.8 N)			
Terminal wire sizes (Cabling/Screw Clamp)	1 or 2, 12–22 AWG (2.05–0.644 mm ²) wires maximum			
Repeatability (linear travel of cam)	0.076 mm (± 0.003 in.)			
Cable entry	1/2-14 NPT standard, optional M20 x 1.5 mm for ISO cable entry			

- To lock the nut in the desired position, crimp the slot near the bottom of the nut.
- Does not include mushroom button. Must be ordered separately from page 189.

Dimensions:
pages 182 to 185





Limit Switches

9007C Heavy Duty Industrial—Plug-in Body, Metal Standard Body—Reed Contacts

Type of head **Rotary (lever arm type) (1)**

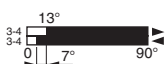
Standard plug-in body type

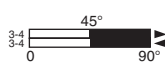

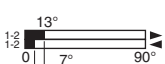
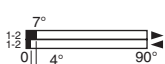
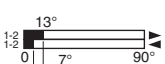
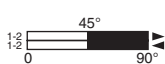
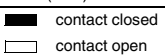
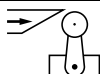
Type of operator	Standard pre-travel spring return	Low differential spring return	Light operating torque spring return	Maintained contact
Type of direction	CW & CCW (2)	CW & CCW (2)	CW & CCW (2)	CW (trip) CCW (reset)
Catalog numbers				
1 N.O. Reed contacts snap action 	9007C84B2 	9007C84A2 	9007C84N2 	9007C84C 
1 N.C. Reed contacts snap action 	9007C86B2 	9007C86A2 	9007C86N2 	9007C86C 
Weight, kg (lb)	0.568 (1.25)	0.568 (1.25)	0.568 (1.25)	0.568 (1.25)
Contact operation				
Characteristics (nominal operating data)				
Switch actuation	By 30° cam			
Type of actuation				
Pre-travel	13°	7°	13°	45°
Total travel	90°			
Differential	7°	4°	7°	—
Reverse overtravel	90°	90°	90°	—
Operating torque force 1 pole & 2 pole	4 lb-in (17.8 N•m)		25 oz-in (0.18 N•m)	3 lb-in (0.34 N•m)
Terminal wire sizes (Cabling/Screw Clamp)	1 or 2, 12–22 AWG (2.05–0.644 mm ²) wires maximum			
Repeatability (linear travel of cam)	0.15 mm (± 0.006 in.)	0.076 mm (± 0.003 in.)	0.15 mm (± 0.006 in.)	0.15 mm (± 0.006 in.)
Cable entry	1/2-14 NPT standard, optional M20 x 1.5 mm for ISO cable entry			

- Lever arm type must be ordered separately from pages 190 to 195.
- These devices are factory set to operate the contacts in **both** the CW and CCW directions. **Mode of operation** is field convertible to CW only or CCW only. **To order factory converted devices:** For CCW only operation, change the **2** at the end of the Type number to **1** (for example, C54B2 becomes C54B1). For CW only operation, delete the **2** at the end of the Type number (for example, C54B2 becomes C54B).



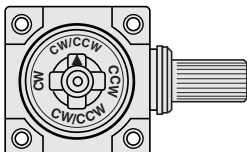









Mode of operation of the lever arm is easily convertible to clockwise or both.
Simply pull out and rotate the arrow to the letters representing the desired direction—CW, CCW, or CW/CCW.

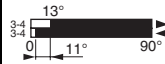
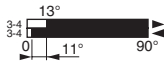
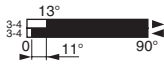
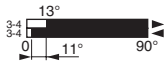
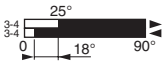

Dimensions:
pages 182 to 185

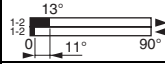
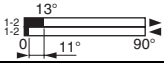
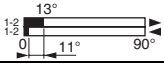
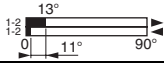
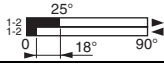
Limit Switches

9007C Heavy Duty Industrial—Plug-in Body, Metal Standard Body—Reed Contacts

Type of head	Flexible operator (wobble stick)				
Standard plug-in body type					
Type of operator	Universal (1)	Wobble stick Delrin® extension (1)	Wobble stick wire extension (1)	Wobble stick coil spring extension (1)	Cat whisker
Catalog numbers					
1 N.O. Reed contacts snap action 	9007C84JKC 	9007C84J 	9007C84K 	9007C84KC 	9007C84L 
1 N.C. Reed contacts snap action 	9007C86JKC 	9007C86J 	9007C86K 	9007C86KC 	9007C86L 
Weight, kg (lb)	0.568 (1.25)	0.568 (1.25)	0.568 (1.25)	0.568 (1.25)	0.568 (1.25)
Contact operation	 contact closed  contact open				
Characteristics (nominal operating data)					
Switch actuation	By any moving object in any direction				
Type of actuation					
Pre-travel	13° (any direction)				25°
Total travel	90°				
Differential	11°				18°
Reverse overtravel	—				
Operating torque/force 1 pole & 2 pole	3 lb-in (0.34 N•m)				7 oz-in (0.05 N•m)
Terminal wire sizes (Cabling/Screw Clamp)	1 or 2, 12–22 AWG (2.05–0.644 mm ²) wires maximum				
Repeatability (linear travel of cam)	—				
Cable entry	1/2-14 NPT standard, optional M20 x 1.5 mm for ISO cable entry				

1. Wobble stick extensions are available separately for the universal head. See page 189.
 Acceptable wire sizes: 12-22 AWG Recommended,
 Terminal clamp torque: 7 lb-in (0.80 N•m).

Dimensions:
 pages 182 to 185

Limit Switches

9007C Heavy Duty Industrial—Plug-in Body, Metal Compact Body

Type of head **Side Plunger (mounting by the body)**

Compact plug-in body type



Type of operator	Side roller plunger spring return vertical roller (1)	Side push rod plunger spring return	Side push rod plunger adjustable (2) spring return	Side push rod plunger maintained contact
------------------	---	-------------------------------------	--	--

Catalog numbers

1 N.O. 1 N.C. snap action	9007C52F	9007C52G	9007C52GD	9007C52H

Weight, kg (lb)	0.456 (1.01)	0.445 (0.98)	0.422 (0.93)	0.568 (1.25)
-----------------	--------------	--------------	--------------	--------------

Contact operation	
-------------------	--

Characteristics (nominal operating data)





Switch actuation	On end		
Type of actuation			
Pre-travel	2 mm (0.08 in.)	3.6 mm (0.14 in.)	
Pre-travel two Stage	First stage	2 mm (0.08 in.)	—
	First stage to second stage	0.5 mm (0.02 in.)	—
Total travel	6.3 mm (0.25 in.)	6.3 mm (0.25 in.)	
Differential	0.8 mm (0.03 in.)	—	
Reverse overtravel	—	—	
Minimum force or torque 1 pole & 2 pole	4 lb (17.8 N)	7 lb (31.1 N)	
Terminal wire sizes (Cabling/Screw Clamp)	1 or 2, 12–22 AWG (2.05–0.644 mm ²) wires maximum		
Repeatability (linear travel of cam)	0.03 mm (0.001 in.)	—	
Cable entry	1/2-14 NPT standard, optional M20 x 1.5 mm for ISO cable entry. Prewired options available.		

- Can be converted to horizontal roller type in the field. To order horizontal roller version add the letter H at the end of the equivalent vertical roller version type.
- To lock the nut in the desired position, crimp the slot near the bottom of the nut.

Dimensions:
pages 182 to 185

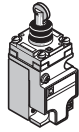
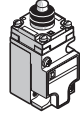
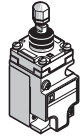
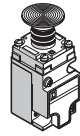
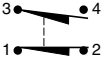
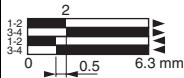
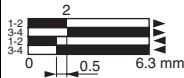
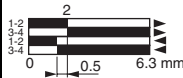
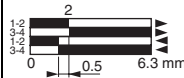
Limit Switches

9007C Heavy Duty Industrial—Plug-in Body, Metal Compact Body

Type of head	Top Plunger (mounting by the body)			
Compact plug-in body type				
Type of operator	Top roller plunger spring return	Top push rod plunger spring return	Top push rod plunger adjustable (1) spring return	Palm operated (2)
Catalog numbers				
1 N.O. 1 N.C. snap action 	9007C52D 	9007C52E 	9007C52ED 	9007C52R (2) 
Weight, kg (lb)	0.169 (0.43)	0.169 (0.43)	0.422 (0.93)	0.568 (1.25)
Contact operation	 contact closed  contact open			
Characteristics (nominal operating data)				
Switch actuation	On end			
Type of actuation				
Pre-travel	2 mm (0.08 in.)			
Pre-travel two Stage	First stage	2 mm (0.08 in.)		
	First stage to second stage	0.03 mm (0.01 in.)		
Total travel	6.3 mm (0.25 in.)			
Differential	0.5 mm (0.02 in.)			
Reverse overtravel				
Minimum force or torque 1 pole & 2 pole	3 lb (13.3 N)			
Terminal wire sizes (Cabling/Screw Clamp)	1 or 2, 12–22 AWG (2.05–0.644 mm ²) wires maximum			
Repeatability (linear travel of cam)	0.03 mm (0.001 in.)			
Cable entry	1/2-14 NPT standard, optional M20 x 1.5 mm for ISO cable entry. Prewired options available.			

- To lock the nut in the desired position, crimp the slot near the bottom of the nut.
- Does not include mushroom button. Must be ordered separately see page 189.

Dimensions:
pages 182 to 185

Limit Switches

9007C Heavy Duty Industrial—Plug-in Body, Metal Compact Body

Type of head **Rotary (lever arm type) (1)**

Compact plug-in body type



Type of operator	Standard pre-travel spring return	Low differential spring return	Light operating torque spring return	Maintained contact
Type of direction	CW & CCW (2)	CW & CCW (2)	CW & CCW (2)	CW (trip) CCW (reset)
Catalog numbers				
1 N.O. 1 N.C. snap action	9007C52B2	9007C52A2	9007C52N2	9007C52C
Weight, kg (lb)	0.481 (1.06)	0.481 (1.06)	0.481 (1.06)	0.481 (1.06)
Contact operation				
Characteristics (nominal operating data)				
Switch actuation	By 30° cam			
Type of actuation				
Pre-travel	10°	5°	10°	45°
Pre-travel two Stage				
First stage	10°	5°	10°	—
First stage to second stage	2.5°	1.5°	2.5°	—
Total travel	90°	90°	90°	90°
Differential	4°	2°	4°	—
Reverse overtravel	90°	90°	90°	—
Operating torque/force	4 lb-in (0.45 N•m)		25 oz-in (0.18 N•m)	3 lb-in (0.34 N•m)
Terminal wire sizes (Cabling/Screw Clamp)	1 or 2, 12–22 AWG (2.05–0.644 mm ²) wires maximum			
Repeatability (linear travel of cam)	0.05 mm (± 0.002 in.)	0.03 mm (± 0.001 in.)	0.05 mm (± 0.002 in.)	0.05 mm (± 0.002 in.)
Cable entry	1/2-14 NPT standard, optional M20 x 1.5 mm for ISO cable entry			

- Lever arm type must be ordered separately from pages 190 to 195.
- These devices are factory set to operate the contacts in **both** the CW and CCW directions. **Mode of operation** is field convertible to CW only or CCW only.
To order factory converted devices: For CCW only operation, change the 2 at the end of the Type number to 1 (for example, C52B2 becomes C52B1). For CW only operation, delete the 2 at the end of the Type number (for example, C52B2 becomes C52B).

Mode of operation of the lever arm is easily convertible to clockwise or both.
Simply pull out and rotate the arrow to the letters representing the desired direction—CW, CCW, or CW/CCW.

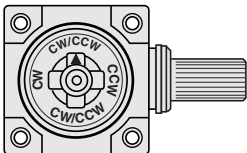

Dimensions:
pages 182 to 185

Limit Switches

9007C Heavy Duty Industrial—Plug-in Body, Metal Compact Body

Type of head **Flexible operator (wobble stick)**

Compact plug-in body type

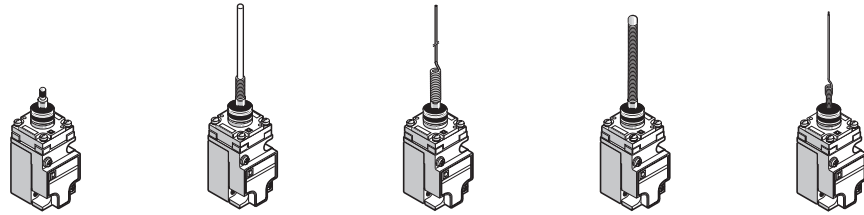

Type of operator	Universal (1)	Wobble stick Delrin® extension (1)	Wobble stick wire extension (1)	Wobble stick coil spring extension (1)	Cat whisker
Catalog numbers					
1 N.O. 1 N.C.					
	9007C52JKC 	9007C52J 	9007C52K 	9007C52KC 	9007C52L
Weight, kg (lb)	0.468 (1.03)	0.568 (1.25)	0.540 (1.19)	0.568 (1.25)	0.468 (1.03)
Contact operation					
Characteristics (nominal operating data)					
Switch actuation	By any moving				
Type of actuation					
Pre-travel	10° (any direction)				20°
Pre-travel two stage					
First stage	10° (any direction)				20°
First stage to second stage	4°				5°
Total travel	90°				
Differential	3°				6°
Reverse overtravel	—				
Operating torque/force	3 lb-in (0.34 N•m)				7 oz-in (0.05 N•m)
Terminal wire sizes (Cabling/Screw Clamp)	1 or 2, 12–22 AWG (2.05–0.644 mm ²) wires maximum				
Repeatability (linear travel of cam)	—				
Cable entry	1/2-14 NPT standard, optional M20 x 1.5 mm for ISO cable entry				

1. Wobble stick extensions are available separately for the universal head. See page 189.

Dimensions:
pages 182 to 185

Limit Switches

9007C Heavy Duty Industrial—Plug-in Body, Metal

Factory Modifications (Forms)



S9

Rotary head shown with S9 option

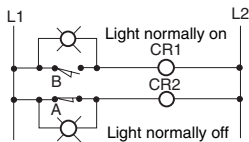

Form P5 Thru P9

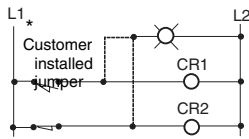

Form P10

* Only one of the jumpers may be used.
Pilot light is ON when load is energized

Special features and modifications

Special features do not apply to 9007CR unless noted. Not field installable, except where noted.

Shaft equipped with hub for mounting larger diameter lever used with 9007T/FT limit switches

Any rotary lever arm 9007C, CF or CR switch can be furnished with an optional shaft and hub combination which will accept the lever arms normally used with 9007T and FT limit switches. To order, add S9 as suffix to the device number. For example, to order a 9007C54B2 with this modification, order as a 9007C54B2S9. For details about switches and lever arms that can be furnished with this modification, see the appropriate catalog or the Digest.

Description	Suffix to add to the device catalog number	Weight kg (lb)
Optional hub for 9007T/FT levers	S9	0.018 (0.04)

Hub only: can be field installed on rotary shaft; see accessories, page 181

Addition of LED pilot light (1)

Description	Suffix to add to the device catalog number	Weight kg (lb)
Addition of LED pilot light in parallel with N.O. contact (light normally on)	P5 (2)	0.57 (1.25)
Addition of LED pilot light in parallel with N.C. contact (light normally off)	P6 (2)	0.57 (1.25)
Addition of two LED pilot lights, one in parallel with N.O. contact (light normally on), one in parallel with N.C. contact (light normally off)	P7	0.57 (1.25)
Addition of two LED pilot lights in parallel with N.O. contacts (lights normally on)	P8 (3)	0.57 (1.25)
Addition of two LED pilot lights in parallel with N.C. contacts (lights normally off)	P9 (3)	0.57 (1.25)
Addition of one isolated LED pilot light (light on when load is energized)	P10 (4)	0.57 (1.25)

LED Pilot light, 24 to 120 V AC or DC on plug-in type switch (9007C52, C54, C62, C66, C68 or (2))

1. Bleeder circuit must be added to ensure PLC compatibility.
2. 9007C84 and C86 are available with P5 or P6 pilot lights only.
3. 9007C62, C66 or C68 only.
4. 9007C54 only. Not available with prewired receptacles.

Examples of complete units with pilot lights in standard plug-in body type

Single pole	Catalog number	Weight kg (lb)
Side plunger	9007C54FP6	0.57 (1.25)
	9007C54DP6	0.57 (1.25)
Top plunger	9007C54EP6	0.57 (1.25)
	9007C54BP6	0.57 (1.25)
Rotary	9007C54LP6	0.57 (1.25)
Wobble stick	9007C54JP6	0.57 (1.25)
	9007C54BP6	0.57 (1.25)
Two poles		
Side plunger	9007C62FP6	0.57 (1.25)
	9007C62DP6	0.57 (1.25)
Top plunger	9007C62EP6	0.57 (1.25)
	9007C62BP6	0.57 (1.25)
Rotary	9007C62LP6	0.57 (1.25)
Wobble stick	9007C62JP6	0.57 (1.25)
	9007C62BP6	0.57 (1.25)

Limit Switches

9007C Heavy Duty Industrial—Plug-in Body, Metal

Factory Modifications (Forms)

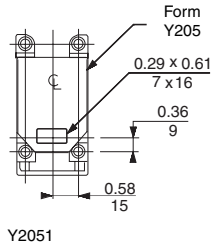

Special features and modifications (continued)

Special features do not apply to 9007CR unless noted. Not field installable, except where noted.

Manifold mounting

Description	Suffix to add to the device catalog number	Weight kg (lb)
Manifold mounting available on standard and compact types. Replaces existing type B installations if new hole is drilled to match knockout. Supersedes type C with form Y205. Receptacle is furnished with a wiring hole and a gasket in the base.	Y2051	0.57 (1.25)
Special chemical resistant coating (includes Viton® fluorocarbon seals—Y140, and stainless steel head and body screws) (1)	L3	0.57 (1.25)
Low temperature – lever types only: limit switch will operate in an ambient temperature range of -40 to 185 °F (standard limit switch ambient temperature range is -20 to 185 °F). Minimum temperature is based on the absence of freezing moisture or water.	Y128	0.57 (1.25)
Viton fluorocarbon gaskets and seals (1) Substitution of Viton fluorocarbon gaskets and seals on:		
Lever arm type, standard box (Viton fluorocarbon shaft seals on lever arm types as standard)	Y140	0.57 (1.25)
Lever arm type, compact box (Viton fluorocarbon shaft seals on lever arm types as standard)	Y140	0.57 (1.25)
Plunger type, standard box	Y140	0.57 (1.25)
Plunger type, compact box	Y140	0.57 (1.25)
Substitution of Viton fluorocarbon boot only on plunger type switches	Y1401	0.57 (1.25)

1. Fluorocarbon (as found in Viton seals) has been shown to resist sunlight aging problems.

Mini and micro connectors, ISO M20 (Form M11)

To order 9007C with ISO M 20 thread add the suffix M11 to the device number.

Examples of complete unit catalog numbers with ISO M20 thread in standard plug-in body type

Type of head	Catalog number	Weight kg (lb)
Single pole		
Side plunger	9007C54FM11	0.57 (1.25)
Top plunger	9007C54DM11	0.57 (1.25)
	9007C54EM11	0.57 (1.25)
Rotary		
	9007C54B2M11	0.57 (1.25)
Wobble stick		
	9007C54LM11	0.57 (1.25)
	9007C54JM11	0.57 (1.25)
Two poles		
Side plunger	9007C62FM11	0.57 (1.25)
Top plunger	9007C62DM11	0.57 (1.25)
	9007C62EM11	0.57 (1.25)
Rotary		
	9007C62B2M11	0.57 (1.25)
Wobble stick		
	9007C62LM11	0.57 (1.25)
	9007C62JM11	0.57 (1.25)

Limit Switches

9007C Heavy Duty Industrial—Plug-in Body, Metal

Factory Modifications (Forms)



Y190•

Standard body shown with Y190• option

Special features and modifications (continued)

Special features do not apply to 9007CR unless noted. Not field installable, except where noted.

Pre-wired receptacle (1) (2)

Description	For use	Suffix to add to the device catalog number	Weight kg (lb)
Plug-in limit switch furnished with pre-wired mini 5-pin Brad Harrison male connector			
Single pole	For use with Brad Harrison female portable plug No.41306, 41307 or 41308 (or equal).	Y1901	0.60 (1.33)
	Same as Y1901 but with different wire color coding	Y1905	0.60 (1.33)
Tamper proof screws in complete switch only			
Single pole	Same as Y1901 but with tamper proof screws on head and body	Y1903	0.60 (1.33)
	Similar to Y1905 except for double pole device	Y19013	0.60 (1.33)

1. Plug and cable assemblies: see accessories page 181
2. Not available with P10 or for Hazardous location switches

Examples of complete unit catalog numbers with mini or micro connectors in standard plug-in body type

Type of head	Catalog number	Weight kg (lb)
Single pole, 5-pin mini connector (7/8"-16 UN-2A thread)		
Side plunger	9007C54FY1901	0.57 (1.25)
Top plunger	9007C54DY1901	0.57 (1.25)
	9007C54EY1901	0.57 (1.25)
Rotary	9007C54B2Y1901	0.57 (1.25)
Wobble stick	9007C54LY1901	0.57 (1.25)
	9007C54JY1901	0.57 (1.25)
Two poles, 9-pin mini connector (1-2/8"-16 UN-2A thread)		
Side plunger	9007C62FY19016	0.57 (1.25)
Top plunger	9007C62DY19016	0.57 (1.25)
	9007C62EY19016	0.57 (1.25)
Rotary	9007C62B2Y19016	0.57 (1.25)
Wobble stick	9007C62LY19016	0.57 (1.25)
	9007C62JY19016	0.57 (1.25)
Single pole, 5-pin micro single key (M12 x 1 thread)		
Side plunger	9007C62FY1912	0.57 (1.25)
Top plunger	9007C54DY1912	0.57 (1.25)
	9007C54EY1912	0.57 (1.25)
Rotary	9007C54B2Y1912	0.57 (1.25)
Wobble stick	9007C54LY1912	0.57 (1.25)
	9007C54JY1912	0.57 (1.25)
Single pole, 5-pin micro connector two keys (1/2"-20 UNF-2A thread)		
Side plunger	9007C54FY19019	0.57 (1.25)
Top plunger	9007C54DY19019	0.57 (1.25)
	9007C54EY19019	0.57 (1.25)
Rotary	9007C54B2Y19019	0.57 (1.25)
Wobble stick	9007C54LY19019	0.57 (1.25)
	9007C54JY19019	0.57 (1.25)



Form Y1901, Y1903

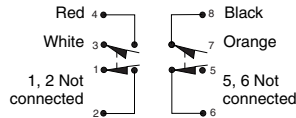

Form Y19013



Form Y1905

Limit Switches

9007C Heavy Duty Industrial—Plug-in Body, Metal

Factory Modifications (Forms)



Y18**
Terminal base shown
with Y18** option

Special features and modifications (continued)

Special features do not apply to 9007CR unless noted. Not field installable, except where noted.

Potted limit (position) switch or plug-in receptacle only (1)

Description (2)			Suffix to add to the device catalog number	Weight kg (lb)
With individual wires	Single pole	With five #16 wires five feet long	Y1841	0.59 (1.30)
	Two pole	With nine #16 wires five feet long	Y1842	0.60 (1.32)
With STOWA cord	Single pole	With five conductor #16 STOWA cord eight feet long	Y1851	1.30 (2.88)
	Single pole	Same as Y1851 but with different wire color coding	Y1855	1.30 (2.88)
	Two pole	With nine conductor #16 STOWA cord eight feet long	Y1852	1.31 (2.90)
	Two pole	Same as Y1852 but with different wire color coding	Y1856	1.31 (2.90)
Tamper proof screws—complete switch only				
With individual wires	Same as Y1841 but with tamper proof screws on head and body		Y1843	0.59 (1.30)
	Same as Y1842 but with tamper proof screws on head and body		Y1844	0.60 (1.32)
With STOWA cord	Same as Y1851 but with tamper proof screws on head and body		Y1853	1.30 (2.88)
	Same as Y1852 but with tamper proof screws on head and body		Y1854	1.30 (2.88)
	Same as Y1855 but with tamper proof screws on head and body		Y1857	1.31 (2.90)
	Same as Y1856 but with tamper proof screws on head and body		Y1858	1.31 (2.90)

- Not for 9007CR Hazardous location devices
- Wire entry completely sealed with epoxy resin.

Dust boot (protects against abrasive dusts, dirt, grit and sand)

Description	Suffix to add to the device catalog number	Weight kg (lb)	
Lever type limit switch furnished with a boot around the shaft	On all 9007C and 9007CR lever type switches	Y33	0.01 (0.01)
Dust boot only	See accessories, page 181		

Wiring Diagrams

Forms Y1851 and Y1853

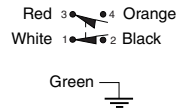

Forms Y1852 and Y1854

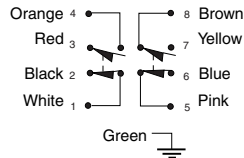

Forms Y1855 and Y1857

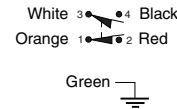

Forms Y1856 and Y1858

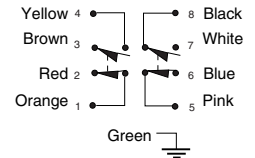

Limit Switches

9007C Heavy Duty Industrial—Plug-in Body, Metal

Factory Modifications (Forms)

Special features and modifications (continued)

Special features do not apply to 9007CR unless noted. Not field installable, except where noted.

Optional shafts

Description	Suffix to add to the device catalog number	Weight kg (lb)
Optional shaft, 7.8 mm (0.306 in.) diameter: To accommodate lever arms from the obsolete Denison C limit switches. Available on all 9007C, CF, or CR limit switches	Y247	0.57 (1.25)
Optional shaft, 7.1 mm (0.28 in.) diameter: Available on all 9007C, CF, or CR limit switches	Y249	0.57 (1.25)

Switch with adapter plate

Description	Suffix to add to the device catalog number	Weight kg (lb)
Switch with adapter plate permitting substitution of any 9007C switch with standard body for any type T switch with style B base plate	Y147	—

Direct acting contacts / Positive opening contacts ☞ Y1561

One pole, normally closed, slow make-slow break, direct acting contact mechanism substituted for standard snap switch on 9007C52, C54 and CR53 devices.

This mechanism was designed for use in emergency overtravel applications. The movable contact of this basic switch unit is acted upon directly by the actuating mechanism of the limit switch and is not dependent upon the force exerted by a snap switch blade or spring to open the circuit. Because these contacts are slow make-slow break, they are best suited for applications where they are not actuated during normal operation, but only if abnormal overtravel is encountered.

Electrical contact ratings

AC—NEMA A600 maximum current—35 % power factor						DC maximum current			
Volts	Make		Break		Continuous carrying A	Volts	Make or break		Continuous carrying A
	A	VA	A	VA			A	VA	
120	60	7200	6	720	10	125	1.1/0.55 (1)	138/69 (1)	5/2.5 (1)
240	30	7200	3	720	10	—	—	—	—
480	15	7200	1.5	720	10	250	0.27	67.5	2.5
600	12	7200	1.2	720	10	600	0.10	60	2.5

1. 9007C52 compact unit ratings at 125 Vdc—same ratings as 9007C54 and 9007CR53 at other voltages.

Description	Suffix to add to the device catalog number	Weight kg (lb)
Direct acting contact/positive opening contact block (slow break single pole only)	Y1561	0.566 (1.25)

Limit Switches

9007C Heavy Duty Industrial—Plug-in Body, Metal Accessories

Accessories		
Hub only		
Description	Catalog number	Weight kg (lb)
Hub can be field installed on any 9007C lever type switch, increasing the shaft diameter from 0.375–0.749 in. (9.53–19 mm), to accept levers normally used with 9007T/FT switches.	9007S9	0.02 (0.04)
Dust boot only		
Description	Catalog number	Weight kg (lb)
Dust boot can be field installed on any 9007C and CR lever type switch	9007BT3	0.01 (0.01)
Conduit seal insert (field instable)		
Description	Catalog number	Weight kg (lb)
Conduit seal fits in conduit entrance and excludes liquids		
5 hole seal	31032-488-01	0.01 (0.02)
9 hole seal	31032-815-01	0.01 (0.02)
Plug and cable assemblies		
Description	Catalog number	Weight kg (lb)
5-pin mini connecting cables (to fit certain switches with Form Y190**)		
Plug and 3 ft (0.91 m) cable	BH20-5-3	—
Plug and 6 ft (1.83 m) cable	BH20-5-6	—
Plug and 12 ft (3.66 m) cable	BH20-5-12	—
Note: Other cables available. See the Machine Cabling section of the Sensors catalog, 9006CT0101.		
Adapter—Field installable		
Description	Catalog number	Weight kg (lb)
Adapter plate kit only Plate plus mounting screws for substitution of any 9007C switch with standard box for any 9007T switch with style B base plate	9007BT1	0.23 (0.50)
Adapter plate for direct substitution of any 9007C plunger switches for 9007B plug-in plunger switches—use only if there is a problem in lining up cam tracks		
Standard body type	9007CT10 (1)	0.13 (0.28)
Compact body type	9007CT13 (2)	0.01 (0.20)
Adapter plate kit permitting direct substitution of any 9007C lever arm switch with standard box for any 9007AW lever arm switch	9007CT11	0.23 (0.50)
20 mm conduit connection adapter male 0.5 in. (12.7 mm) NPT on one end, female 0.787 in. (20 mm) on other end	9007CT12	0.01 (0.20)

1. Dimensions: 0.22 x 2.94 x 1.54 in. (5.6 x 75 x 39 mm)
2. Dimensions: 0.22 x 2.07 x 1.54 in. (5.6 x 53 x 39 mm)

Limit Switches

9007C Heavy Duty Industrial—Plug-in Body, Metal

Dimensions—Standard Body

Side Plunger

9007C**F

9007C**G

9007C**GD

9007C**H

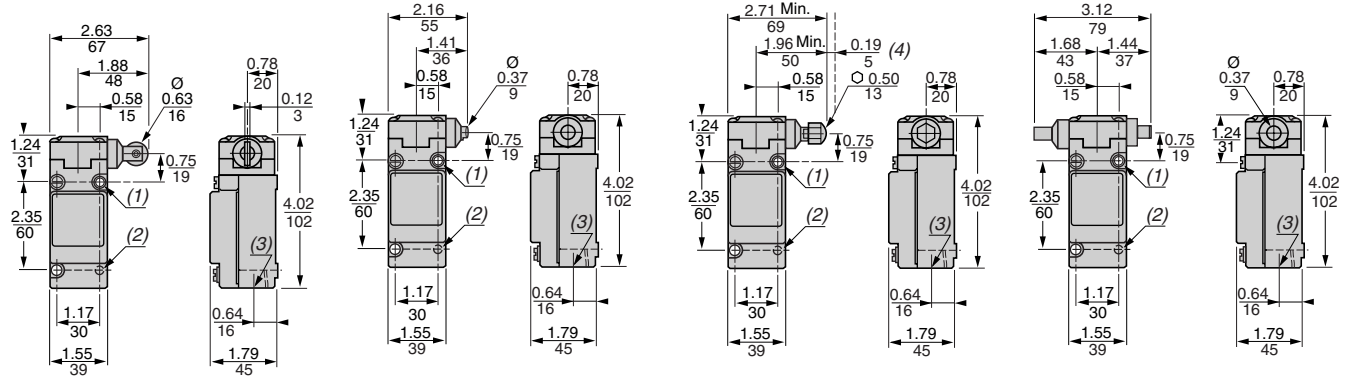

Dual dimensions: $\frac{\text{in.}}{\text{mm}}$

1. 2 x 0.20/5 x 0.22/6 HLS.
2. 2 x 10-24 Tapped HLS Back Mtg 0.29/7 DP.
3. 1/2 14 NPT.
4. Adjustable.

Top Plunger

9007C**D

9007C**E

9007C**ED

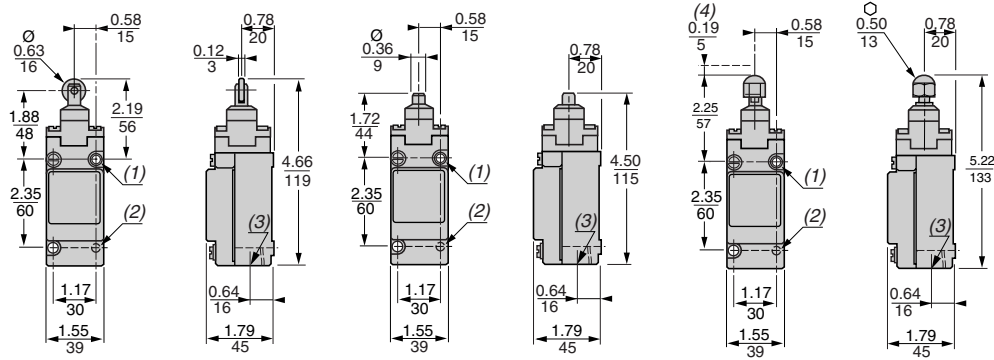

Dual dimensions: $\frac{\text{in.}}{\text{mm}}$

1. 2 x 0.20/5 x 0.22/6 HLS.
2. 2 x 10-24 Tapped HLS Back Mtg 0.29/7 DP.
3. 1/2 14 NPT.
4. Adjustable.

Limit Switches

9007C Heavy Duty Industrial—Plug-in Body, Metal

Dimensions—Standard Body

Rotary

9007C*** A, B, C, N, T5, T10

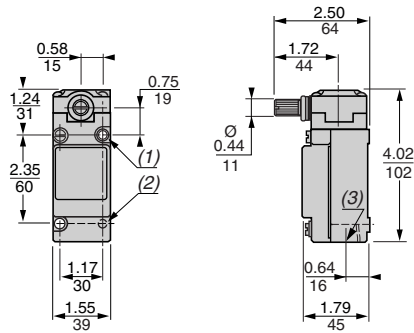

Dual dimensions: $\frac{\text{in.}}{\text{mm}}$

1. 2 x 0.20/5 x 0.22/6 HLS.
2. 2 x 10-24 Tapped HLS Back Mtg 0.29/7 DP.
3. 1/2 14 NPT.

Wobble stick

9007C**JKC

9007C**J

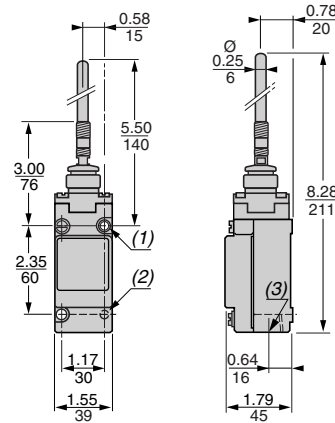
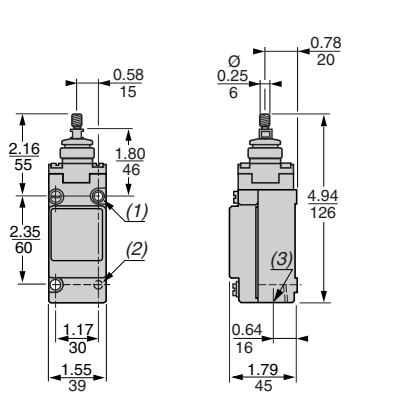

9007C**K

9007C**KC

9007C**L

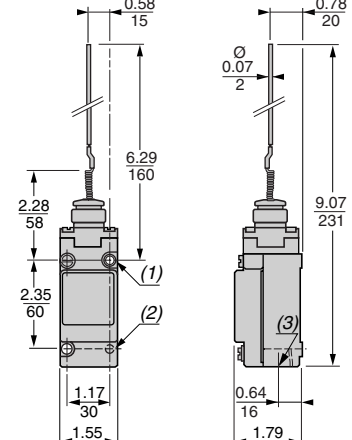
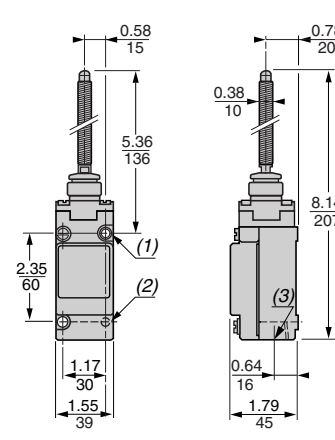
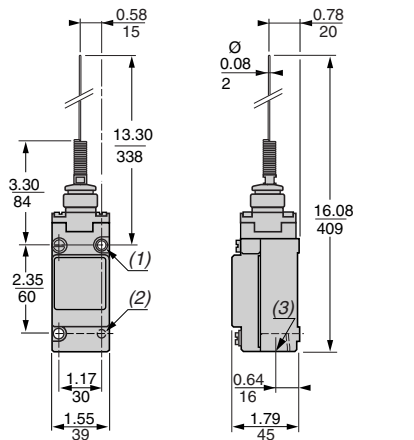

Dual dimensions: $\frac{\text{in.}}{\text{mm}}$

1. 2 x 0.20/5 x 0.22/6 HLS.
2. 2 x 10-24 Tapped HLS Back Mtg 0.29/7 DP.
3. 1/2 14 NPT.

Limit Switches

Limit Switches

9007C Heavy Duty Industrial—Plug-in Body, Metal

Dimensions—Compact Body

Side Plunger

9007C52F

9007C52G

9007C52GD

9007C52H

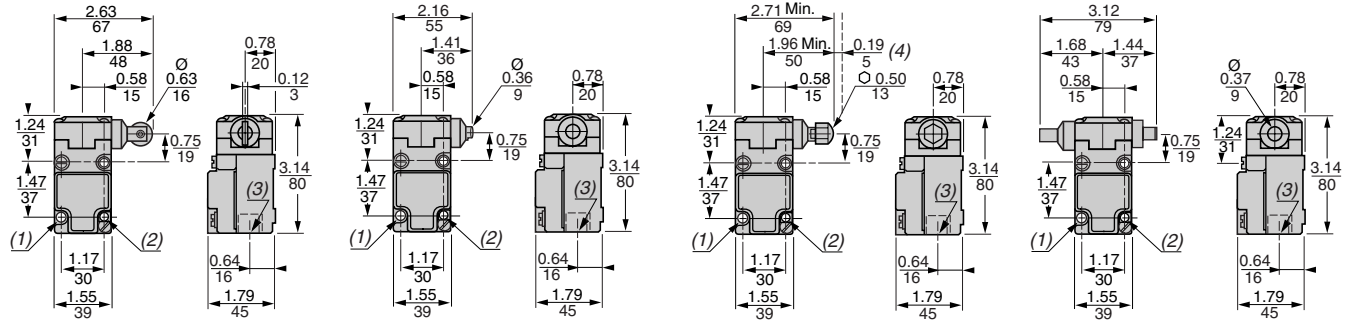

Dual dimensions: $\frac{\text{in.}}{\text{mm}}$

1. 2 x 0.20/5 HLS.
2. 2 x 10-24 Tapped HLS Back Mtg 0.20/5 DP.
3. 1/2 14 NPT.
4. Adjustable.

Top Plunger

9007C52D

9007C52E

9007C52ED

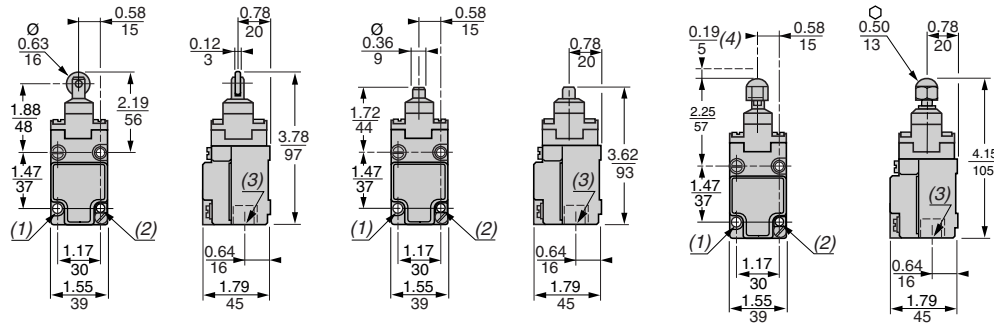

Dual dimensions: $\frac{\text{in.}}{\text{mm}}$

1. 2 x 0.20/5 HLS.
2. 2 x 10-24 Tapped HLS Back Mtg 0.20/5 DP.
3. 1/2 14 NPT.
4. Adjustable.

Limit Switches

9007C Heavy Duty Industrial—Plug-in Body, Metal Dimensions—Compact Body

Rotary

9007C52•• A, B, C, N, T5, T10

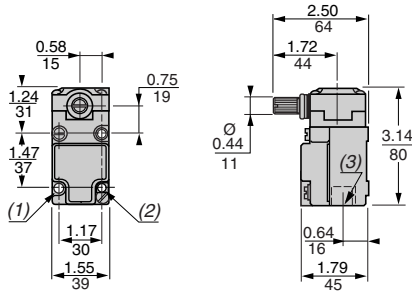

Dual dimensions: $\frac{\text{in.}}{\text{mm}}$

1. 2 x 0.20/5 x 0.22/6 HLS.
2. 2 x 10-24 Tapped HLS Back Mtg 0.29/7 DP.
3. 1/2 14 NPT.

Wobble stick

9007C52JKC

9007C52J

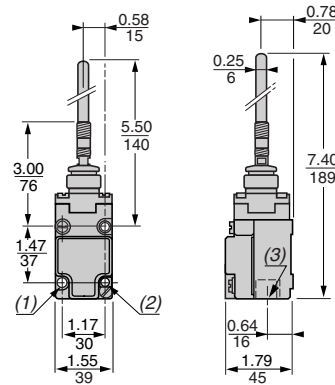
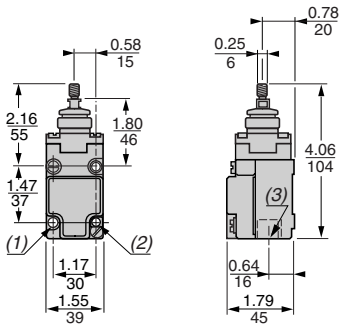

9007C52K

9007C52KC

9007C52L

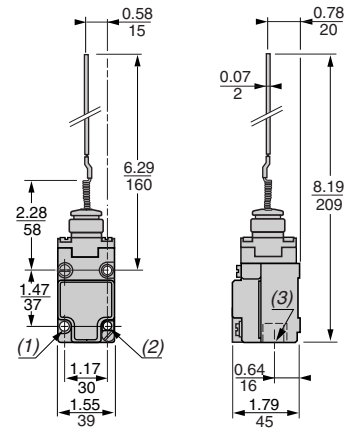
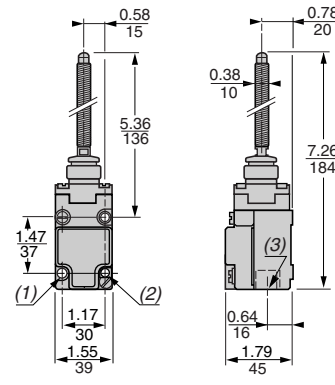
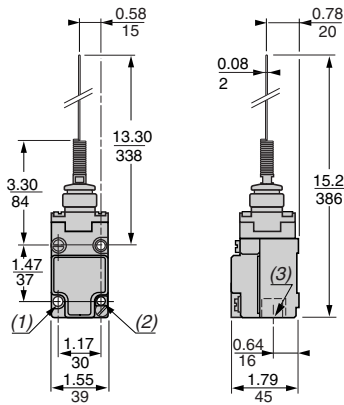

Dual dimensions: $\frac{\text{in.}}{\text{mm}}$

1. 2 x 0.20/5 x 0.22/6 HLS.
2. 2 x 10-24 Tapped HLS Back Mtg 0.29/7 DP.
3. 1/2 14 NPT.

Limit Switches

9007C Heavy Duty Industrial—Plug-in Body, Metal Adaptable Sub-Assemblies

Limit Switches

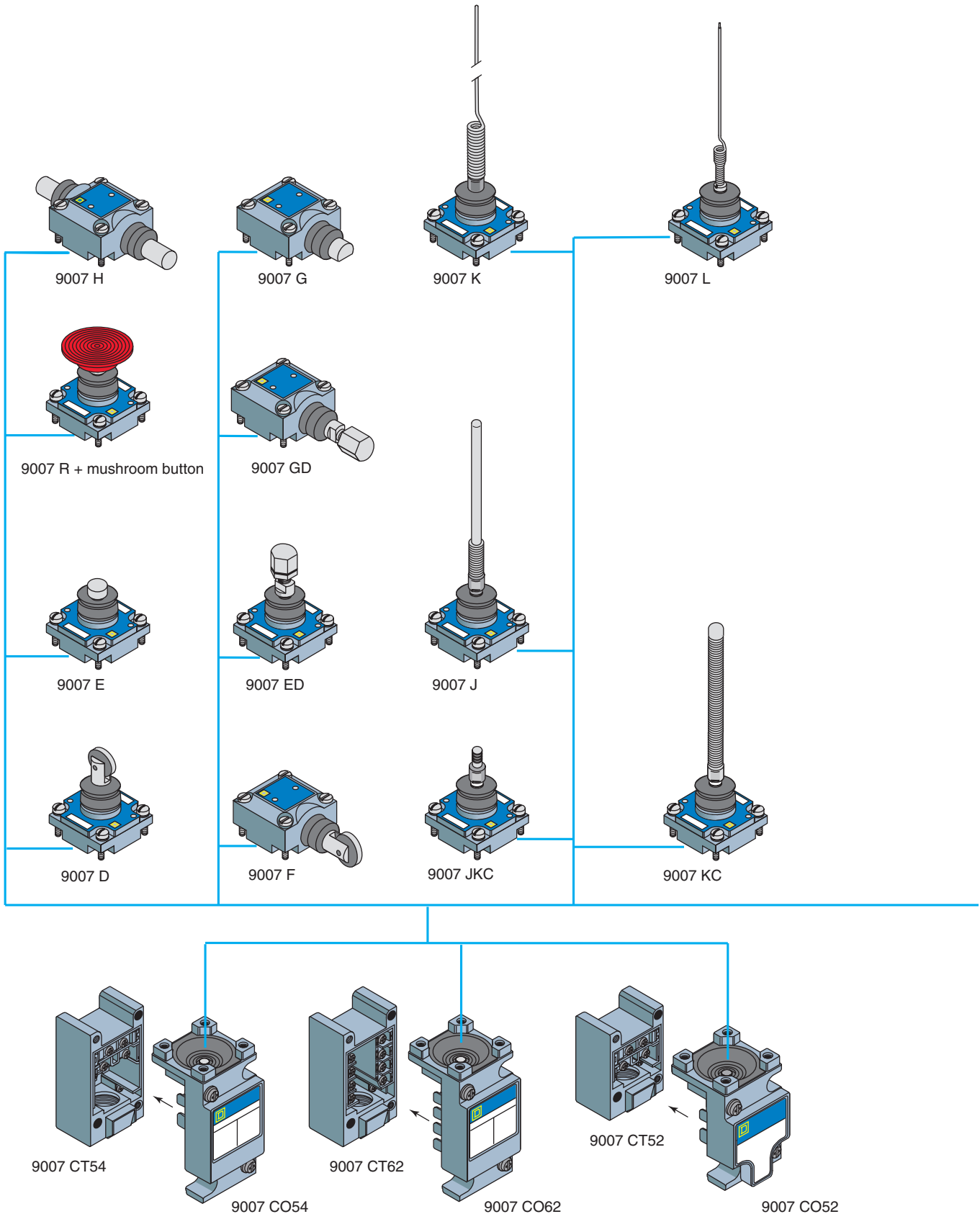

Limit Switches
9007C Heavy Duty Industrial—Plug-in Body, Metal
Adaptable Sub-Assemblies

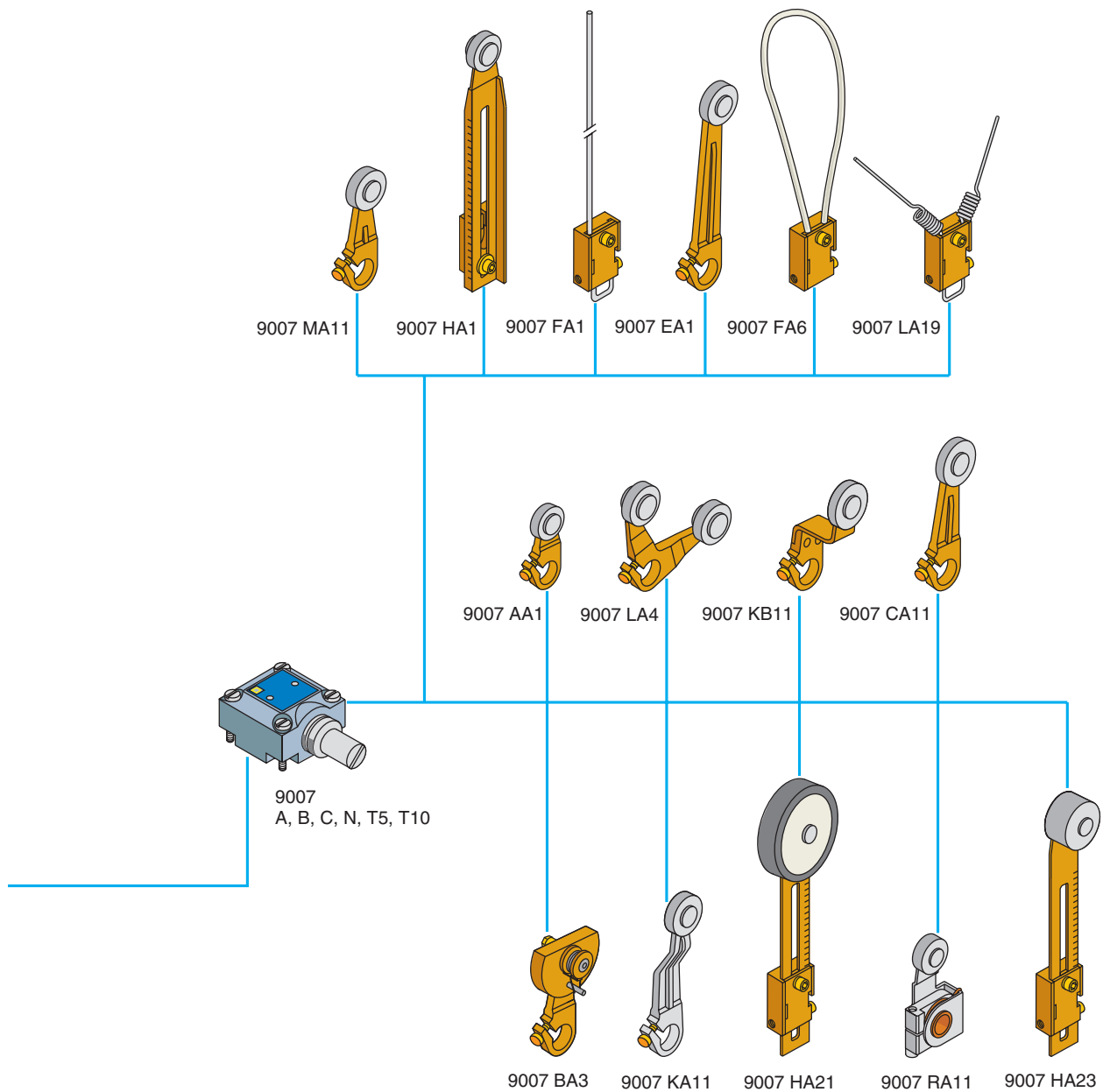

Limit Switches

9007C Heavy Duty Industrial—Plug-in Body, Metal

Adaptable Sub-Assemblies

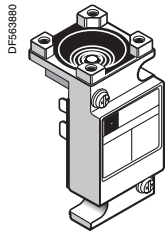

9007CO54

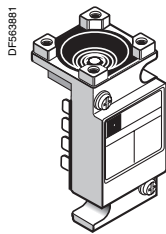

9007CO62

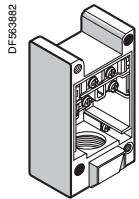

9007CT54

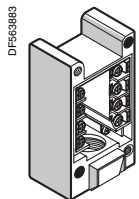

9007CT62

Limit Switches

Body with contacts for plunger or rotary heads Plug-in Unit (Top) with contacts

Type	Type of contact	Function diagram	Catalog number	Weight kg (lb)
For standard plug-in body type	Single pole		9007CO54	0.19 (0.42)
	Two pole		9007CO62	0.20 (0.44)
	Two stage		9007CO66	0.23 (0.50)
	Neutral position		9007CO68	0.20 (0.45)
For compact plug-in body type	Single pole		9007CO52	0.18 (0.40)

Plug-in Receptacle (Base) with screw terminals (1)

Type	Type of contact	Function diagram	Catalog number	Weight kg (lb)
For standard plug-in body type	Single pole		9007CT54	0.22 (0.48)
	Two pole		9007CT62	0.22 (0.48)
	Neutral position		9007CT62	0.22 (0.48)
	Two stage		9007CT62	0.22 (0.48)
	Reed switches, either N/O or N/C (2)		9007CT54	0.22 (0.48)
For compact plug-in body type	Single pole		9007CT52	0.15 (0.34)

1. Acceptable wire sizes: 12-22 AWG (2.05 mm²-0.644mm²). Recommended terminal clamp torque: 7 lb-in (0.80 N•m).
2. Reed switches: plug-in switches less heads are not available as separate units. Order complete plug-in unit with a head. Example: 9007C084B2.

Dimensions:
page 196

Limit Switches

9007C Heavy Duty Industrial—Plug-in Body, Metal

Adaptable Sub-Assemblies

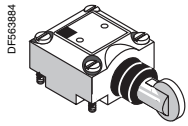

9007F

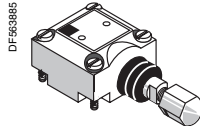

9007GD

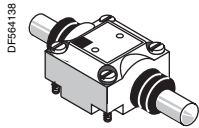

9007H

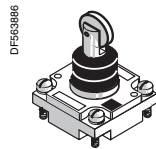

9007D

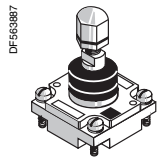

9007ED

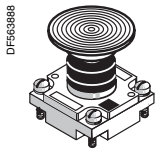

9007R + mushroom button

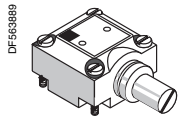

9007C

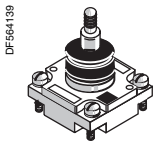

9007JKC

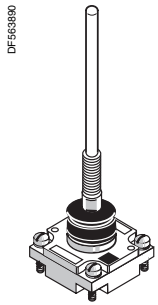

9007J

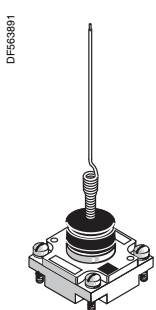

9007L

Heads for linear, rotary and multi-directional movements

Side plunger heads

Type of operator	Catalog number	Weight kg (lb)
Side roller plunger, spring return, vertical roller (1)	9007F	0.16 (0.36)
Side push rod plunger, spring return	9007G	0.15 (0.34)
Side push rod plunger, adjustable spring return	9007GD	0.16 (0.36)
Side push rod plunger, maintained contact	9007H	0.16 (0.36)

Top plunger heads

Type of operator	Catalog number	Weight kg (lb)
Top roller plunger, spring return	9007D	0.12 (0.26)
Top push rod plunger, spring return	9007E	0.11 (0.24)
Top push rod plunger, adjustable spring return	9007ED	0.12 (0.27)
Palm operated turret head without mushroom button	9007R	0.13 (0.28)
Mushroom button see Accessories (below)		

Rotary heads (without lever arm type)

Type of operator	Type of direction	Catalog number	Weight kg (lb)
Standard pre-travel spring return	CW & CCW	9007B	0.19 (0.41)
Low differential spring return	CW & CCW	9007A	0.19 (0.41)
Neutral position	CW & CCW	9007T10	0.16 (0.36)
Standard pre-travel spring return			
Neutral position	CW & CCW	9007T5	0.16 (0.36)
Low differential spring return			
Extra light operating torque spring return	CW & CCW	9007N	0.18 (0.40)
Maintained contact	CW (trip) CCW (reset)	9007C	0.19 (0.41)

Multi-directional head

Type of operator	Catalog number	Weight kg (lb)
Universal (2)	9007JKC	0.19 (0.41)
Wobble stick, Delrin® extension (2)	9007J	0.20 (0.43)
Wobble stick, wire extension (2)	9007K	0.26 (0.57)
Wobble stick, coil spring extension (2)	9007KC	0.22 (0.48)
Cat whisker	9007L	0.17 (0.37)

Accessories

Description	Diameter in. (mm)	Color	Catalog number	Weight kg (lb)
Mushroom button for palm operated turret head	1.38 (35)	Black	2358C6G3	0.03 (0.06)
		Red	2358C6G2	0.03 (0.06)
		Green	2358C6G6	0.03 (0.06)
		Yellow	2358C6G8	0.03 (0.06)
	2.25 (57.2)	Black	—	—
		Red	2358C22G3	0.05 (0.10)
Green		2358C22G6	0.05 (0.10)	
Yellow	2358C22G8	0.05 (0.10)		
Description (2)	Type of extension	Catalog number	Weight kg (lb)	
Wobble stick extensions for the universal head	Delrin® extension	9007WJ	0.01 (0.03)	
	Wire extension	9007WK	0.01 (0.02)	
	Coil spring extension	9007WKC	0.02 (0.04)	

- Field convertible to horizontal.
- Acceptable wire sizes: 12-22 AWG (2.05 mm²-0.644mm²).
Recommended terminal clamp torque: 7 lb-in (0.80 N•m).

Dimensions:
page 196

Limit Switches

9007C Heavy Duty Industrial—Plug-in Body, Metal

Lever Arms for Rotary Heads

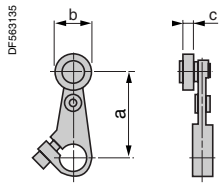

a: Length of lever Arm
b: Roller diameter
c: Roller width



9007AA1



9007MA11

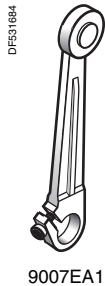

9007EA1

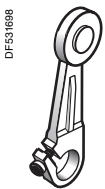

9007CA11

Cast zinc lever arms with standard roller

Lever arms with steel roller (1)

Arm	Steel roller		Catalog number	Weight kg (lb)
Length (a) in. (mm)	Diameter (b) in. (mm)	Width (c) in. (mm)		
0.88 (22)	0.63 (16)	0.25 (6.3)	9007AA1	0.02 (0.05)
		0.63 (16)	9007AA2	0.03 (0.07)
1.38 (35)	0.75 (19)	0.25 (6.3)	9007BA11	0.03 (0.07)
		0.63 (16)	9007BA12	0.05 (0.10)
	0.63 (16)	0.25 (6.3)	9007BA1	0.03 (0.07)
		0.63 (16)	9007BA2	0.04 (0.08)
1.5 (38)	0.75 (19)	0.25 (6.3)	9007MA11	0.03 (0.07)
		0.63 (16)	9007MA12	0.05 (0.11)
	0.63 (16)	0.25 (6.3)	9007MA1	0.03 (0.06)
		0.63 (16)	9007MA2	0.05 (0.10)
2 (51)	0.75 (19)	0.25 (6.3)	9007CA11	0.04 (0.08)
		0.63 (16)	9007CA12	0.05 (0.12)
	0.63 (16)	0.25 (6.3)	9007CA1	0.04 (0.08)
		0.63 (16)	9007CA2	0.05 (0.10)
2.5 (63.5)	0.75 (19)	0.25 (6.3)	9007DA11	0.05 (0.10)
		0.63 (16)	9007DA12	0.06 (0.13)
	0.63 (16)	0.25 (6.3)	9007DA1	0.04 (0.08)
		0.63 (16)	9007DA2	0.05 (0.11)
3 (76)	0.75 (19)	0.25 (6.3)	9007EA11	0.05 (0.10)
		0.63 (16)	9007EA12	0.06 (0.14)
	0.63 (16)	0.25 (6.3)	9007EA1	0.04 (0.09)
		0.63 (16)	9007EA2	0.06 (0.14)

Lever arms with nylon roller

Arm	Nylon roller		Catalog number	Weight kg (lb)
Length (a) in. (mm)	Diameter (b) in. (mm)	Width (c) in. (mm)		
0.88 (22)	0.63 (16)	0.25 (6.3)	9007AA8	0.02 (0.05)
		0.63 (16)	9007AA17	0.03 (0.07)
1.38 (35)	0.75 (19)	0.25 (6.3)	9007BA18	0.03 (0.07)
		0.63 (16)	9007BA8	0.05 (0.10)
	1 (25.4)	0.25 (6.3)	9007BA17	0.05 (0.11)
		0.63 (16)	9007BA4	0.03 (0.06)
1.5 (38)	0.75 (19)	0.25 (6.3)	9007BA13	0.05 (0.10)
		0.63 (16)	9007MA18	0.03 (0.06)
	0.63 (16)	0.25 (6.3)	9007MA8	0.05 (0.10)
		0.63 (16)	9007MA17	0.05 (0.10)
2 (51)	1 (25.4)	0.25 (6.3)	9007MA4	0.05 (0.10)
		0.63 (16)	9007MA13	0.05 (0.12)
	0.75 (19)	0.25 (6.3)	9007MA18	0.05 (0.10)
		0.63 (16)	9007CA8	0.03 (0.06)
2.5 (63.5)	0.63 (16)	0.25 (6.3)	9007CA17	0.03 (0.07)
		0.63 (16)	9007CA4	0.05 (0.12)
	1 (25.4)	0.25 (6.3)	9007CA13	0.06 (0.14)
		0.63 (16)	9007DA18	0.03 (0.07)
3 (76)	0.75 (19)	0.25 (6.3)	9007DA8	0.06 (0.13)
		0.63 (16)	9007DA17	0.06 (0.13)
	1 (25.4)	0.25 (6.3)	9007DA4	0.06 (0.14)
		0.63 (16)	9007DA13	0.07 (0.15)
3 (76)	0.75 (19)	0.25 (6.3)	9007EA18	0.04 (0.08)
		0.63 (16)	9007EA8	0.06 (0.14)
	0.63 (16)	0.25 (6.3)	9007EA17	0.07 (0.16)
		0.63 (16)	9007EA4	0.07 (0.15)
1 (25.4)	0.25 (6.3)	9007EA13	0.08 (0.17)	
	0.63 (16)	9007EA13	0.08 (0.17)	

1. Material is hardened, oil-impregnated, sintered iron.

Dimensions:
page 197

Limit Switches

9007C Heavy Duty Industrial—Plug-in Body, Metal

Lever Arms for Rotary Heads

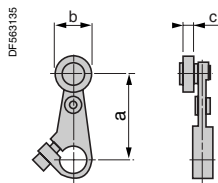

a: Length of lever Arm
b: Roller diameter
c: Roller width

Cast zinc lever arms (continued)

Lever arms with ball bearing roller

Arm	Ball bearing roller		Catalog number	Weight kg (lb)
Length (a) in. (mm)	Diameter (b) in. (mm)	Width (c) in. (mm)		
0.88 (22)	0.69 (17.5)	0.25 (6.3)	9007AA9	0.04 (0.09)
1.38 (35)	0.69 (17.5)	0.25 (6.3)	9007BA9	0.04 (0.09)
1.5 (38)	0.69 (17.5)	0.25 (6.3)	9007MA9	0.04 (0.09)
2 (51)	0.69 (17.5)	0.25 (6.3)	9007CA9	0.04 (0.09)
2.5 (63.5)	0.69 (17.5)	0.25 (6.3)	9007DA9	0.04 (0.09)
3 (76)	0.69 (17.5)	0.25 (6.3)	9007EA9	0.04 (0.09)

Lever arms with roller on opposite side to standard

Lever arm	Roller on opposite side		Catalog number	Weight kg (lb)
Length (a) in. (mm)	Diameter (b) in. (mm)	Width (c) in. (mm)		
0.88 (22)	0.63 (16)	0.25 (6.3)	9007AA5	0.04 (0.09)
	0.63 (16)	0.63 (16)	9007AA6	0.04 (0.09)
1.38 (35)	0.75 (19)	0.25 (6.3)	9007BA15	0.04 (0.09)
	0.63 (16)	0.25 (6.3)	9007BA5	0.04 (0.09)
1.5 (38)	0.63 (16)	0.63 (16)	9007BA6	0.04 (0.09)
	0.75 (19)	0.25 (6.3)	9007MA15	0.04 (0.09)
2 (51)	0.63 (16)	0.25 (6.3)	9007MA5	0.04 (0.09)
	0.63 (16)	0.63 (16)	9007MA6	0.04 (0.09)
2.5 (63.5)	0.75 (19)	0.25 (6.3)	9007CA15	0.04 (0.09)
	0.63 (16)	0.25 (6.3)	9007CA5	0.04 (0.09)
3 (76)	0.63 (16)	0.63 (16)	9007CA6	0.04 (0.09)
	0.75 (19)	0.25 (6.3)	9007DA15	0.04 (0.09)
2.5 (63.5)	0.63 (16)	0.25 (6.3)	9007DA5	0.04 (0.09)
	0.63 (16)	0.63 (16)	9007DA6	0.04 (0.09)
3 (76)	0.75 (19)	0.25 (6.3)	9007EA15	0.04 (0.09)
	0.63 (16)	0.25 (6.3)	9007EA5	0.04 (0.09)
3 (76)	0.63 (16)	0.63 (16)	9007EA6	0.04 (0.09)

Lever arms with roller countersunk roller pin

Arm	Roller (countersunk roller pin)		Catalog number	Weight kg (lb)
Length (a) in. (mm)	Diameter (b) in. (mm)	Width (c) in. (mm)		
1.5 (38)	0.75 (19)	0.25 (6.3)	9007MA31	0.03 (0.07)
2 (51)	0.75 (19)	0.25 (6.3)	9007CA31	0.04 (0.08)
2.5 (63.5)	0.75 (19)	0.25 (6.3)	9007DA31	0.04 (0.09)

Lever arms with cable operated with eyebolt (I.D.) instead of roller

Arm	Cable	Catalog number	Weight kg (lb)
Length in. (mm)	Length in. (mm)		
1.5 (38)	0.38 (9.6)	9007MA22	0.05 (0.10)

Dimensions:
page 197

Limit Switches

9007C Heavy Duty Industrial—Plug-in Body, Metal

Lever Arms for Rotary Heads

DF563135

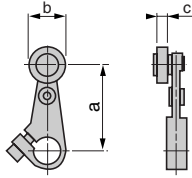

a: Length of lever Arm
b: Roller diameter
c: Roller width

Flat steel lever arms with standard roller (1)				
Arm	Roller		Catalog number	Weight kg (lb)
Length(a) in. (mm)	Diameter (b) in. (mm)	Width (c) in. (mm)		
Lever arms with steel roller				
0.88 (22)	0.63 (16)	0.25 (6.3)	9007AA1S	0.01 (0.03)
	0.63 (16)	0.63 (16)	9007AA2S	0.01 (0.03)
1.38 (35)	0.63 (16)	0.25 (6.3)	9007BA1S	0.01 (0.03)
	0.63 (16)	0.63 (16)	9007BA2S	0.01 (0.03)
2 (51)	0.63 (16)	0.25 (6.3)	9007CA1S	0.03 (0.07)
	0.63 (16)	0.63 (16)	9007CA2S	0.04 (0.08)
2.5 (63.5)	0.63 (16)	0.25 (6.3)	9007DA1S	0.04 (0.08)
	0.63 (16)	0.63 (16)	9007DA2S	0.04 (0.08)
3 (76)	0.63 (16)	0.25 (6.3)	9007EA1S	0.04 (0.08)
	0.63 (16)	0.63 (16)	9007EA2S	0.04 (0.08)
Lever arms with nylon roller				
1.38 (35)	1 (25.4)	0.25 (6.3)	9007BA4S	0.01 (0.03)
1.5 (38)	0.75 (19)	0.25 (6.3)	9007MA18S	0.01 (0.03)
2 (51)	1 (25.4)	0.25 (6.3)	9007CA4S	0.03 (0.07)
2.5 (63.5)	1 (25.4)	0.25 (6.3)	9007DA4S	0.04 (0.08)
3 (76)	1 (25.4)	0.25 (6.3)	9007EA4S	0.04 (0.08)
Lever arms without roller				
0.88 (22)	—	—	9007AA0S	
1.38 (35)	—	—	9007BA0S	0.01 (0.02)
2 (51)	—	—	9007CA0S	0.03 (0.06)
2.5 (63.5)	—	—	9007DA0S	0.03 (0.07)
3 (76)	—	—	9007EA0S	0.03 (0.07)

1. Material is hardened, oil-impregnated, sintered iron.

90° Forked cast zinc lever arms					
Arm	Roller position	Roller		Catalog number	Weight kg (lb)
Length(a) in. (mm)		Diameter(b) in. (mm)	Width(c) in. (mm)		
Lever arms with steel roller					
1.5 (38)	Rollers on same side	0.75 (19)	0.25 (6.3)	9007LA4	0.05 (0.12)
		0.63 (16)	0.25 (6.3)	9007LA1	0.07 (0.15)
	R.H. Roller on opposite side	0.75 (19)	0.25 (6.3)	9007LA5	0.05 (0.12)
		0.63 (16)	0.25 (6.3)	9007LA2	0.07 (0.15)
	L.H. Roller on opposite side	0.75 (19)	0.25 (6.3)	9007LA6	0.05 (0.12)
		0.63 (16)	0.25 (6.3)	9007LA3	0.07 (0.15)
Lever arms with nylon rollers					
1.5 (38)	Rollers on same side	0.75 (19)	0.25 (6.3)	9007LA16	0.04 (0.09)
		1 (25.4)		9007LA10	0.06 (0.14)
	R.H. Roller on opposite side	0.75 (19)	0.25 (6.3)	9007LA17	0.04 (0.09)
		1 (25.4)		9007LA11	0.06 (0.14)
	L.H. Roller on opposite side	0.75 (19)	0.25 (6.3)	9007LA18	0.04 (0.09)
		1 (25.4)		9007LA12	0.06 (0.14)
Lever arms with ball bearing rollers					
1.5 (38)	Rollers on same side	0.69 (17.5)	0.25 (6.3)	9007LA7	0.11 (0.25)
	R.H. Roller on opposite side	0.69 (17.5)	0.25 (6.3)	9007LA8	0.11 (0.25)
	L.H. Roller on opposite side	0.69 (17.5)	0.25 (6.3)	9007LA9	0.11 (0.25)

DF531682



9007LA4

Limit Switches

Dimensions:
page 197

192

© 1997–2007 Schneider Electric All Rights Reserved



03/2007

Limit Switches

9007C Heavy Duty Industrial—Plug-in Body, Metal

Lever Arms for Rotary Heads

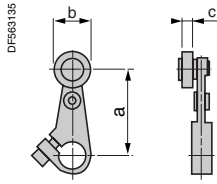

a: Length of lever Arm
b: Roller diameter
c: Roller width



9007RA11

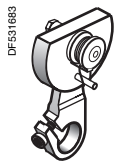

9007BA3

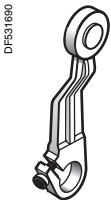

9007KA11

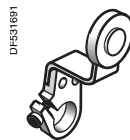

9007KB11

One-way lever arm					
Arm		Steel roller		Catalog number	Weight kg (lb)
Length (a) in. (mm)		Diameter (b) in. (mm)	Width (c) in. (mm)		
Lever arm with standard roller					
1.5 (38)		0.75 (19)	0.25 (6.3)	9007RA11	0.05 (0.12)
Lever arm with nylon roller					
1.5 (38)		0.75 (19)	0.25 (6.3)	9007RA18	0.05 (0.12)
Lever arm with ball bearing roller					
1.5 (38)		0.69 (17.5)	0.25 (6.3)	9007RA9	0.05 (0.12)
Lever arm with rod type					
5 (127)		—	—	9007FA2	0.05 (0.12)
One-way cast zinc roller lever arm					
Arm		Roller		Catalog number	Weight kg (lb)
Length (a) in. (mm)		Diameter (b) in. (mm)	Width (c) in. (mm)		
Cast arm with steel roller					
1.38 (35)		1.25 (32)	0.25 (6.3)	9007BA3	0.07 (0.15)
1.5 (38)		1.25 (32)	0.25 (6.3)	9007MA3	0.10 (0.23)
2 (51)		1.25 (32)	0.25 (6.3)	9007CA3	0.12 (0.27)
2.5 (63.5)		1.25 (32)	0.25 (6.3)	9007DA3	0.12 (0.27)
3 (76)		1.25 (32)	0.25 (6.3)	9007EA3	0.13 (0.29)
Flat steel arm with steel roller					
1.38 (35)		1.25 (32)	0.25 (6.3)	9007BA3S	0.07 (0.15)
2 (51)		1.25 (32)	0.25 (6.3)	9007CA3S	0.10 (0.23)
2.5 (63.5)		1.25 (32)	0.25 (6.3)	9007DA3S	0.12 (0.27)
3 (76)		1.25 (32)	0.25 (6.3)	9007EA3S	0.13 (0.29)
Offset type cast zinc lever arm					
Offset lever arm		Roller		Catalog number	Weight kg (lb)
Length in. (mm)	Offset	Diameter in. (mm)	Width in. (mm)		
Offset cast zinc arm with steel roller					
2 (51)	0.44 (11)	0.63 (16)	0.25 (6.3)	9007KA1	0.04 (0.08)
		0.63 (16)	0.63 (16)	9007KA2	0.04 (0.08)
		0.75 (19)	0.25 (6.3)	9007KA11	0.04 (0.09)
		0.75 (19)	0.63 (16)	9007KA12	0.05 (0.12)
1.5 (38)	0.88 (22)	0.75 (19)	0.25 (6.3)	9007KB11	0.04 (0.10)
		0.75 (19)	0.25 (6.3)	9007KB15	0.04 (0.10)
Offset cast zinc arm with ball bearing roller					
2 (51)	0.44 (11)	0.69 (17.5)	0.25 (6.3)	9007KA9	0.04 (0.10)
Offset cast zinc arm with nylon roller					
2 (51)	0.44 (11)	0.75 (19)	0.25 (6.3)	9007KA18	0.04 (0.10)
		0.75 (19)	1 (25.4)	9007KA21	0.04 (0.10)

Dimensions:
page 197

Limit Switches

9007C Heavy Duty Industrial—Plug-in Body, Metal Lever Arms for Rotary Heads

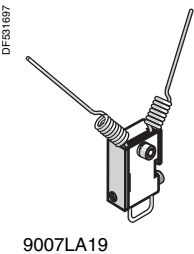
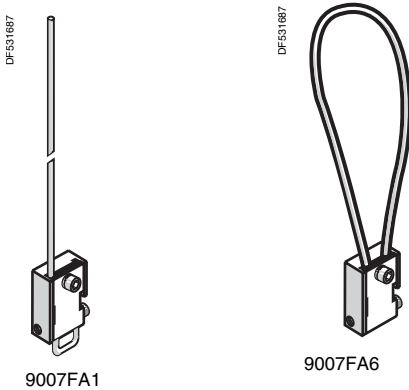
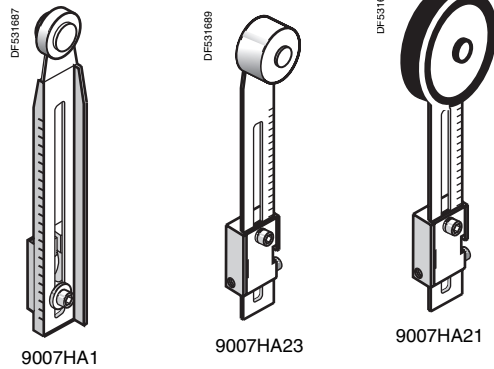
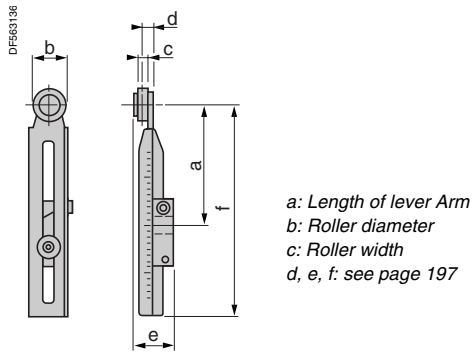

Adjustable length lever arm				
Lever arm	Roller		Catalog number	Weight kg (lb)
Dimensions length (a) in. (mm)	Diameter (b) in. (mm)	Width (c) in. (mm)		
Adjustable length arm with steel roller				
Non-bendable, adjustable from 0.88 (22) to 4 (101)	0.63 (16)	0.25 (6.3)	9007HA1	0.05 (0.12)
	0.63 (16)	0.63 (16)	9007HA2	0.07 (0.14)
Bendable, adjustable from 0.88 (22) to 4 (101)	0.63 (16)	0.25 (6.3)	9007HA5	0.06 (0.14)
	0.63 (16)	0.63 (16)	9007HA6	0.04 (0.18)
Adjustable length arm with nylon roller				
Non-bendable, adjustable from 0.88 (22) to 4 (101)	0.63 (16)	0.25 (6.3)	9007HA4	0.05 (0.12)
	1 (25.4)	0.63 (16)	9007HA22	0.06 (0.13)
	0.63 (16)	0.25 (6.3)	9007HA8	0.06 (0.14)
Bendable, adjustable from 0.88 (22) to 4 (101)	1.0 (16)	0.63 (16)	9007HA23	0.07 (0.16)
	2 (51)	0.25 (6.3)	9007HA26	0.08 (0.17)
Adjustable length arm with ball bearing roller				
Non-bendable, adjustable from 0.88 (22) to 4 (101)	0.69 (17.5)	0.25 (6.3)	9007HA24	0.06 (0.13)
Bendable, adjustable from 0.88 (22) to 4 (101)	0.69 (17.5)	0.25 (6.3)	9007HA25	0.07 (0.16)
Adjustable length arm with ball Delrin® roller				
Bendable, adjustable from 0.88 (22) to 4 (101)	1.63 (41)	0.25 (6.3)	9007HA20	0.07 (0.16)
Adjustable length arm with rubber tire roller				
Bendable, adjustable from 0.88 (22) to 4 (101)	2.13 (54)	0.5 (12.7)	9007HA21	0.10 (0.22)
Adjustable length arm without roller				
Non-bendable, adjustable from 0.88 (22) to 4 (101)	—	—	9007HA0	0.15 (0.33)
Bendable, adjustable from 0.88 (22) to 4 (101)	—	—	9007HA9	0.11 (0.25)
Rod type lever arm				
Description	Length		Catalog number	Weight kg (lb)
Rod	in. (mm)			
Stainless steel rod	10 (254)		9007FA1	0.07 (0.15)
Spring rod, steel	12 (304)		9007FA3	0.07 (0.15)
Spring rod, Delrin®	12 (304)		9007FA5	0.07 (0.15)
Looped Delrin rod arm	—		9007FA6	0.05 (0.11)
90° forked rod				
Spring rods, steel	2.5 (63.5)		9007LA19	0.06 (0.13)

Dimensions:
page 197

Limit Switches

9007C Heavy Duty Industrial—Plug-in Body, Metal

Lever Arms for Rotary Heads

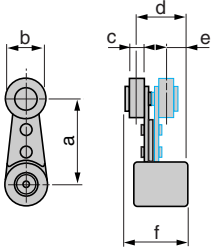

a: Length of lever Arm
 b: Roller diameter
 c: Roller width
 d, e: see page 197

360° angular adjustable lever arm

360° angular adjustable lever arm		Roller		Catalog number	Weight kg (lb)
Length (a) in. (mm)	Roller (1) position	Diameter (b) in. (mm)	Width (c) in. (mm)		
Lever arms with steel roller					
0.88 (22)	Roller outside	0.63 (16)	0.25 (6.3)	9007AA1M	0.09 (0.20)
	Roller inside	0.63 (16)	0.25 (6.3)	9007AA5M	0.09 (0.20)
1.38 (35)	Roller outside	0.75 (19)	0.25 (6.3)	9007AA11M	0.09 (0.20)
	Roller inside	0.63 (16)	0.25 (6.3)	9007BA1M	0.09 (0.22)
1.5 (38)	Roller outside	0.63 (16)	0.25 (6.3)	9007BA5M	0.10 (0.22)
	Roller inside	0.75 (19)	0.25 (6.3)	9007BA11M	0.10 (0.22)
2 (51)	Roller outside	0.63 (16)	0.25 (6.3)	9007MA1M	0.11 (0.24)
	Roller inside	0.63 (16)	0.25 (6.3)	9007MA5M	0.11 (0.24)
2.5 (63.5)	Roller outside	0.75 (19)	0.25 (6.3)	9007MA11M	0.11 (0.24)
	Roller inside	0.63 (16)	0.25 (6.3)	9007CA1M	0.11 (0.24)
3 (76)	Roller outside	0.63 (16)	0.25 (6.3)	9007CA5M	0.11 (0.24)
	Roller inside	0.75 (19)	0.25 (6.3)	9007CA11M	0.11 (0.25)
2.5 (63.5)	Roller outside	0.63 (16)	0.25 (6.3)	9007DA1M	0.11 (0.25)
	Roller inside	0.63 (16)	0.25 (6.3)	9007DA5M	0.12 (0.27)
3 (76)	Roller outside	0.75 (19)	0.25 (6.3)	9007DA11M	0.12 (0.27)
	Roller inside	0.63 (16)	0.25 (6.3)	9007EA1M	0.12 (0.27)
3 (76)	Roller inside	0.63 (16)	0.25 (6.3)	9007EA5M	0.12 (0.27)
	Roller outside	0.75 (19)	0.25 (6.3)	9007EA11M	0.13 (0.29)
Lever arms with nylon roller					
0.88 (22)	Roller outside	0.63 (16)	0.25 (6.3)	9007AA8M	0.09 (0.20)
		0.75 (19)	0.25 (6.3)	9007AA18M	0.09 (0.20)
1.38 (35)	Roller outside	0.63 (16)	0.25 (6.3)	9007BA8M	0.11 (0.25)
		0.75 (19)	0.25 (6.3)	9007BA18M	0.11 (0.25)
1.5 (38)	Roller outside	0.63 (16)	0.25 (6.3)	9007MA8M	0.10 (0.23)
		0.75 (19)	0.25 (6.3)	9007MA18M	0.11 (0.25)
2 (51)	Roller outside	0.63 (16)	0.25 (6.3)	9007CA8M	0.12 (0.27)
		0.75 (19)	0.25 (6.3)	9007CA18M	0.12 (0.27)
2.5 (63.5)	Roller outside	0.63 (16)	0.25 (6.3)	9007DA8M	0.12 (0.27)
		0.75 (19)	0.25 (6.3)	9007DA18M	0.12 (0.27)
3 (76)	Roller outside	0.63 (16)	0.25 (6.3)	9007EA8M	0.12 (0.26)
		0.75 (19)	0.25 (6.3)	9007EA18M	0.12 (0.27)
Lever arms with ball bearing roller					
0.88 (22)	Roller outside	0.69 (17.5)	0.25 (6.3)	9007AA9M	0.10 (0.23)
1.38 (35)	Roller outside	0.69 (17.5)	0.25 (6.3)	9007BA9M	0.11 (0.24)
1.5 (38)	Roller outside	0.69 (17.5)	0.25 (6.3)	9007MA9M	0.19 (0.26)
2 (51)	Roller outside	0.69 (17.5)	0.25 (6.3)	9007CA9M	0.19 (0.26)
2.5 (63.5)	Roller outside	0.69 (17.5)	0.25 (6.3)	9007DA9M	0.12 (0.27)
3 (76)	Roller outside	0.69 (17.5)	0.25 (6.3)	9007EA9M	0.13 (0.28)

1. Roller can be changed in the field from roller outside to roller inside position or vice versa.

Limit Switches

9007C Heavy Duty Industrial—Plug-in Body, Metal Bodies and Heads, Dimensions

Body

Standard

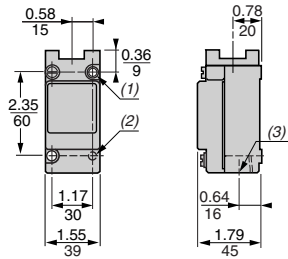

Dual dimensions: $\frac{\text{in.}}{\text{mm}}$

1. 2 x 0.20/5 x 0.22/6 HLS.
2. 2 x 10-24 Tapped HLS Back Mtg 0.29/7 DP.
3. 1/2 14 NPT.

Compact

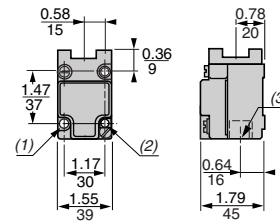

Dual dimensions: $\frac{\text{in.}}{\text{mm}}$

1. 2 x 0.20/5 HLS.
2. 2 x 10-24 Tapped HLS Back Mtg 0.20/5 DP.
3. 1/2 14 NPT.

Side plunger heads

9007F

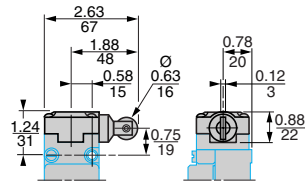

9007G

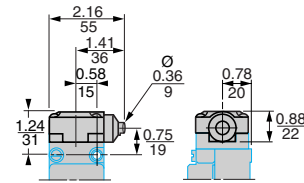

9007GD

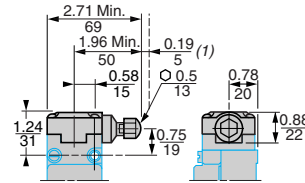

9007H

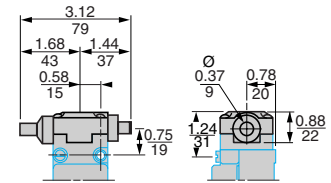

Top plunger heads

9007D

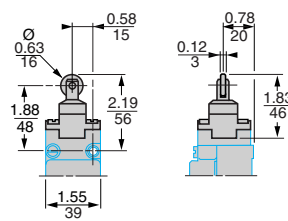

9007E

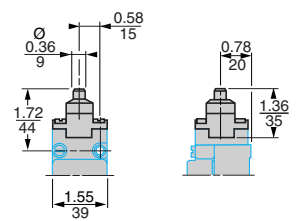

9007ED

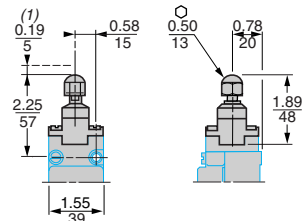

1. Adjustable

Rotary heads

9007C

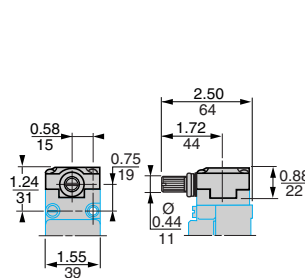

Multi-directional heads

9007JKC

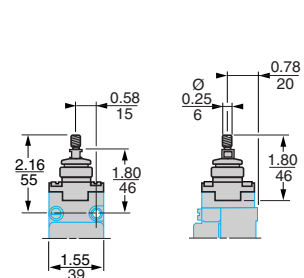

9007J

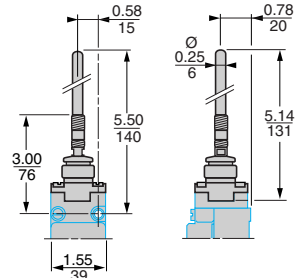

9007KC

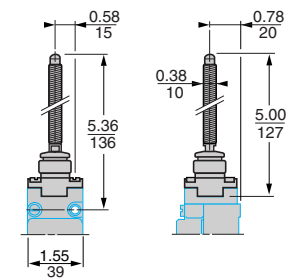

Multi-directional heads (continued)

9007K

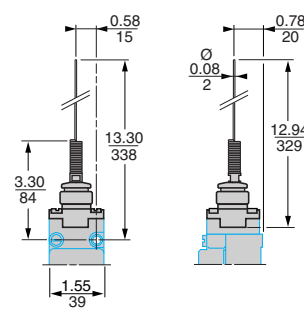

9007L

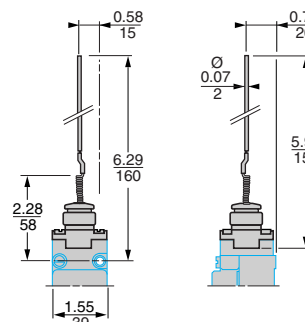

Catalog numbers:
pages 188 and 189

Limit Switches

9007C Heavy Duty Industrial—Plug-in Body, Metal Lever Arms for Rotary Heads, Dimensions

Lever arms

9007AA**, BA**, CA**, DA**, EA**, FA**, KA**, LA**, MA**, RA**

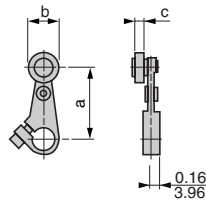

a: Length of lever Arm
b: Roller diameter
c: Roller width

a, b, c: pages 190 to 193

Adjustable length lever arms

9007HA* and 9007HA***

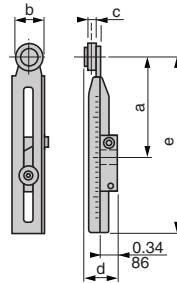

a: Length of lever arm
b: Roller diameter
c: Roller width
d = 0.38/10
e = 4.38/111

a, b, c: page 194

360° angular adjustable lever arms

9007AA**M, 9007BA**M, 9007CA**M, 9007DA**M, 9007EA**M, 9007MA**M

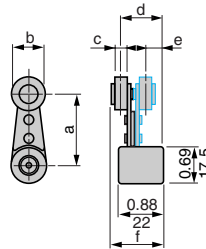

a: Length of lever Arm
b: Roller diameter
c: Roller width
d = 0.84/21
e = 0.38/10
f = 1.05/27

a, b, c: page 195

Rod type lever arms

9007FA1

9007FA6

9007LA19

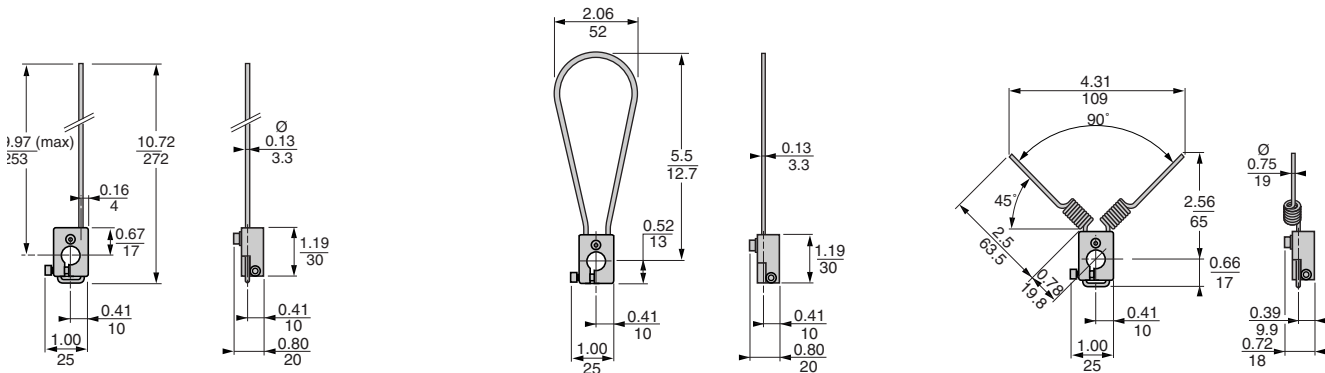

Catalog numbers:
pages 190 to 195

Limit Switches

9007C Heavy Duty Industrial—Non-Plug-in Body, Metal Hazardous Location

Hazardous Non-Plug-in Body Type (1)

With head for linear movement
side plunger

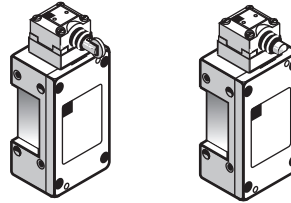

Page 200

top plunger

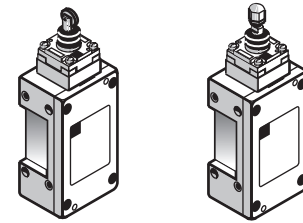

Page 201

With head for rotary movement (lever)

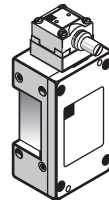

Page 202

With head for multi-directional movement

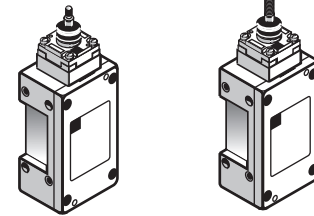

Page 203

1. Factory modifications: see pages 176 to 180.

Application Information—Hazardous Locations

Classification of hazardous locations

Hazardous locations are those areas that **may** have flammable gases or combustible dusts present in quantities sufficient to produce an explosive or ignitable mixture. These gases, dusts, may always be present or may only be present in abnormal situations. The National Electrical Code (NEC) describes these areas in Articles 500 through 503 and divides them into three types of categories: Class, Group, Division.

- **Classes**

The *Classes* (I, II, III) differentiate between the type of hazardous materials: I is for gases, II is for dusts, and III is for fibers.

- **Groups**

The *Groups* (A, B, C, D, E, F, and G) further subdivide each class according to the relative explosive force of the materials. Group A atmosphere is acetylene which has a higher explosive force than Group B (which may contain hydrogen, for example); and Group B has a higher explosive force than Group D, etc.

- **Divisions**

The *Divisions* (1 and 2) refer to the presence of these hazardous gases and dusts. Division 1 areas can have these gases or dusts present **at all times** under **normal operating conditions** in an ignitable concentration. Division 2 areas **only** have **ignitable concentrations** of dusts or gases present during **abnormal conditions**, such as machine failures or container breakage.

The table below summarizes the classifications described above.

Summary of Classification Chart

Class	Division	Group
I. Gas	1. Hazard May Exist May Exist In Atmosphere Under Normal Operating Conditions	A. Acetylene B. Manufactured Gases Containing Hydrogen C. Petrochemicals (e.g. ethylene) D. Petrochemicals (e.g. alcohol)
	2. Potential Hazard A. May be present in atmosphere only under abnormal circumstances.	A. Acetylene B. Manufactured Gases Containing Hydrogen C. Petrochemicals (e.g. ethylene) D. Petrochemicals (e.g. alcohol)
II. Dust	1. Hazard May Exist May Exist In Atmosphere Under Normal Operating Conditions	E. Conductive and Combustible Dust (Resistivity $\leq 10^5$ ohms/cm) F. Carbonaceous Dusts (Resistivity $> 10^2$ ohm/cm but < 108 ohm/cm) G. Non-Conductive Combustible Dust (Resistivity $> = 105$ ohms/cm)
	2. Potential Hazard A. May be present in atmosphere only under abnormal circumstances.	G. Non-Conductive Combustible Dust (Resistivity $> = 105$ ohms/cm)
III. Fibers	1. Production Areas	Easily Ignitable Fibers
	2. Handling and Storage Areas	Easily Ignitable Fibers

Limit Switches

9007C Heavy Duty Industrial—Non-Plug-in Body, Metal Hazardous Location

Environmental characteristics		
Conforming to standards	Products	NEMA 250, EN 60947-1, EN 60947-5-1, IEC 60947, UL 508, C22-2-14-95, CE conformity documentation
	Machine assemblies	IEC 60204-1
Product certifications		UL, CSA, CE
Protective treatment		Epoxy powder coat
Ambient air temperature (Lever/rotary head)	Operation	-20...+185 °F (-29...+85 °C), wider range available
	Storage	-20...+185 °F (-29...+85 °C), wider range available
Vibration resistance	Conforming to IEC 60068-2-6	25 gn (10...150 Hz, 11 ms) (C86F switch good for 18.5g only)
Shock resistance	Conforming to IEC 60068-2-27	60 gn (9 ms) 40 gn (9 ms) for reed switch
Electric shock protection	Conforming to IEC 61140	Class 0
Degree of protection	Conforming to IEC 60529	IP 67
Cable entry or connector	Depending on model	1/2-14 NPT, M20 X 1.5, ISO cable entry, 5-pin mini connector, 4-pin micro connector
Materials	Bodies, heads, levers	Bodies in aluminum, heads in Zamak® zinc alloy, levers and rods in zinc, steel, stainless steel, Delrin® resin.
Contact block characteristics		
Rated operational characteristics hard contacts -AC Voltage	9007CR53 (single pole)	NEMA A600 (Ue = 600 V, Ie = 1.2 A); Ithe = 10 A
	9007CR61 (two pole)	NEMA A600 (Ue = 600 V, Ie = 1.2 A); Ithe = 10 A
	9007CR65 (two pole two stage)	NEMA A600 (Ue = 600 V, Ie = 1.2 A); Ithe = 10 A
	9007CR67 (two pole neutral)	NEMA A600 (Ue = 600 V, Ie = 1.2 A); Ithe = 10 A
Rated operational characteristics hard contacts -DC Voltage	9007CR53 (single pole)	NEMA Q600 (Ue = 600 V, Ie = 0.1 A); Ithe = 2.5 A
	9007CR61 (two pole)	NEMA R300 (Ue = 250 V, Ie = 0.11 A); Ithe = 1.0 A
	9007CR65 (two pole two stage)	NEMA R300 (Ue = 250 V, Ie = 0.11 A); Ithe = 1.0 A
	9007CR67 (two pole neutral)	NEMA R300 (Ue = 250 V, Ie = 0.11 A); Ithe = 1.0 A
Rated insulation voltage		600 V
Rated Impulse Withstand Voltage		2,500 Vac for 1 minute for CE; 2,200 Vac for 1 minute for UL; and 2,640 Vac for 1 s for CSA
Positive Opening	Special Y1561	Special Y1561 (one pole slow break only) ☺
Short Circuit Protection		10 A. Bussman Class CC KTK-R-10 fuse non-time-delay
Terminal wire sizes (Cabling/Screw Clamp)		1 or 2, 12–22 AWG (2.05–0.644 mm ²) wires maximum
Maximum Actuation Speed		50fpm / 90fpm (15.2 m/min / 27.4 m/min) with 45 degree cam angle, levers only
Electrical Durability		1 million operating cycles

Types of contact elements

IEC 60947-5-1			NEMA			JIS		
Form	Symbol	Description	Form	Symbol	Description	Form	Symbol	Description
A		Single break	A		—	3		—
X		Double break						
B		Single break	B		—	2		—
Y		Double break						
C		—	C		—	1		Single break
Za		Same polarity	Z		"Same polarity" only			Double break
Zb		Electrically separate						Double break

Limit Switches

9007C Heavy Duty Industrial—Non-Plug-in Body, Metal Hazardous Location

Type of head Side Plunger (mounting by the body)

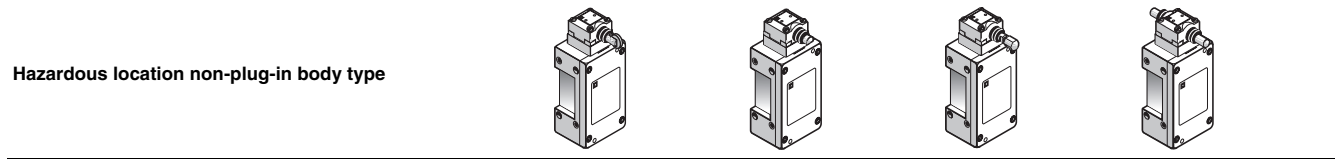

Type of operator	Side roller plunger spring return vertical roller (1)	Side push rod plunger spring return	Side push rod plunger adjustable (2) spring return	Side push rod plunger maintained contact
-------------------------	---	-------------------------------------	--	--

Catalog numbers

1 N.O. 1 N.C. snap action	9007CR53F	9007CR53G	9007CR53GD	9007CR53H
2 N.O. 2 N.C. snap action	9007CR61F	9007CR61G	9007CR61GD	9007CR61H
2 N.O. 2 N.C. Two stage snap action	9007CR65F	9007CR65G	9007CR65GD	
Weight, kg (lb)	1.020 (2.25)	1.020 (2.25)	1.020 (2.25)	1.020 (2.25)

Contact operation	
--------------------------	--

Characteristics (nominal operating data)











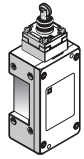
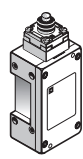
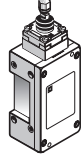
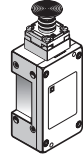
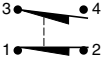

Switch actuation	On end
Type of actuation	
Pre-travel	2 mm (0.08 in.) 3.6 mm (0.14 in.)
Pre-travel two Stage	First stage: 2 mm (0.08 in.) First stage to second stage: 0.5 mm (0.02 in.)
Total travel	6.3 mm (0.25 in.)
Differential	0.8 mm (0.03 in.)
Reverse overtravel	—
Minimum force or torque 1 pole & 2 pole	4 lb (17.8 N) 7 lb (31.1 N)
Terminal wire sizes (Cabling/Screw Clamp)	1 or 2, 12–22 AWG (2.05–0.644 mm ²) wires maximum
Repeatability (linear travel of cam)	0.03 mm (0.001 in.) —
Cable entry	1/2-14 NPT standard, optional M20 x 1.5 mm for ISO cable entry

1. Can be converted to horizontal roller type in the field. To order horizontal roller version add the letter H at the end of the equivalent vertical roller version type.
 2. To lock the nut in the desired position, crimp the slot near the bottom of the nut.

Dimensions:
pages 204 and 205

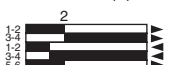
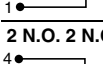
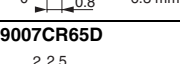
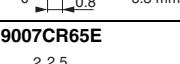
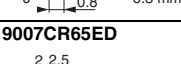
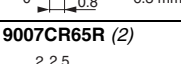
Limit Switches

9007C Heavy Duty Industrial—Non-Plug-in Body, Metal Hazardous Location

Type of head	Top Plunger (mounting by the body)			
Hazardous location non-plug-in body type				
Type of operator	Top roller plunger spring return	Top push rod plunger spring return	Top push rod plunger adjustable (1) spring return	Palm operated (2)
Catalog numbers				
1 N.O. 1 N.C. snap action 	9007CR53D 	9007CR53E 	9007CR53ED 	9007CR53R (2) 
2 N.O. 2 N.C. snap action 	9007CR61D 	9007CR61E 	9007CR61ED 	9007CR61R (2) 
2 N.O. 2 N.C. Two stage snap action 	9007CR65D 	9007CR65E 	9007CR65ED 	9007CR65R (2) 
Weight, kg (lb)	1.020 (2.25)	1.020 (2.25)	1.020 (2.25)	1.020 (2.25)
Contact operation	 contact closed  contact open			
Characteristics (nominal operating data)				
Switch actuation	On end			
Type of actuation				
Pre-travel	2 mm (0.08 in.)			
Pre-travel two Stage	First stage	2 mm (0.08 in.)		
	First stage to second stage	0.3 mm (0.01 in.)		
Total travel	6.3 mm (0.25 in.)			
Differential	0.5 mm (0.02 in.)			
Reverse overtravel	—			
Minimum force or torque	1 pole & 2 pole	3 lb (13.3 N)		7 lb (31.1 N)
Terminal wire sizes (Cabling/Screw Clamp)	1 or 2, 12–22 AWG (2.05–0.644 mm ²) wires maximum			
Repeatability (linear travel of cam)	0.03 mm (0.001 in.)			
Cable entry	1/2-14 NPT standard, optional M20 x 1.5 mm for ISO cable entry			

- To lock the nut in the desired position, crimp the slot near the bottom of the nut.
- Does not include mushroom button. Must be ordered separately see page 189.

Dimensions:
pages 204 and 205

Limit Switches

9007C Heavy Duty Industrial—Non-Plug-in Body, Metal Hazardous Location

Type of head	Rotary (lever arm type) (1)					
Hazardous location non-plug-in body type						
Type of operator	Standard pre-travel spring return	Low differential spring return	Neutral position		Light operating torque spring return	Maintained contact
Type of direction	CW & CCW (2)	CW & CCW (2)	CW & CCW	CW & CCW	CW & CCW (2)	CW (trip) CCW (reset)
Catalog numbers						
1 N.O. 1 N.C. snap action	9007CR53B2 	9007CR53A2 			9007CR53N2 	9007CR53C
2 N.O. 2 N.C. snap action	9007CR61B2 	9007CR61A2 			9007CR61N2 	9007CR61C
2 N.O. 2 N.C. snap action Neutral position			9007CR67T10 	9007CR67T5 		
2 N.O. 2 N.C. two stage snap action	9007CR65B2 	9007CR65A2 			9007CR65N2 	
Weight, kg (lb)	1.020 (2.25)	1.020 (2.25)	1.020 (2.25)	1.020 (2.25)	1.020 (2.25)	1.020 (2.25)
Contact operation	■ contact closed		□ contact open			
Characteristics (nominal operating data)						
Switch actuation	By 30° cam					
Type of actuation						
Pre-travel	10°	5°	10°	5°	10°	45°
Pre-travel two stage						
First stage	10°	5°	—	—	10°	—
First stage to second stage	2.5°	1.5°	—	—	2.5°	—
Total travel	90°					90°
Differential	4°	2°	4°	2°	4°	—
Reverse overtravel	90°					—
Operating torque/force 1 pole & 2 pole	4 lb-in (0.45 N•m)				25 oz-in (0.18 N•m)	3 lb-in (0.34 N•m)
Terminal wire sizes (Cabling/Screw Clamp)	1 or 2, 12–22 AWG (2.05–0.644 mm ²) wires maximum					
Repeatability (linear travel of cam)	0.05 mm (± 0.002 in.)	0.03 mm (± 0.001 in.)	0.05 mm (± 0.002 in.)	0.05 mm (± 0.002 in.)	0.05 mm (± 0.002 in.)	0.05 mm (± 0.002 in.)
Cable entry	1/2-14 NPT standard, optional M20 x 1.5 mm for ISO cable entry					



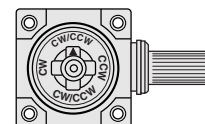

- Lever arm type must be ordered separately from page 190 to 193.
- These devices are factory set to operate the contacts in **both** the CW and CCW directions. **Mode of operation** is field convertible to CW only or CCW only.
To order factory converted devices: For CCW only operation, change the 2 at the end of the Type number to 1 (for example: C54B2 becomes C54B1). For CW only operation, delete the 2 at the end of the Type number (for example, C54B2 becomes C54B).
 Mode of operation of the lever arm is easily convertible to clockwise or both.
 Simply pull out and rotate the arrow to the letters representing the desired direction—CW, CCW, or CW/CCW.

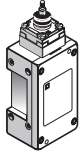
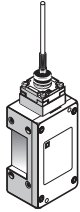
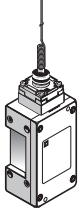
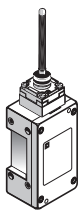
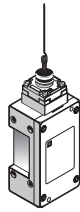
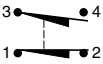
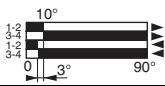
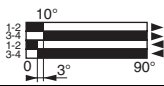
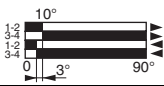
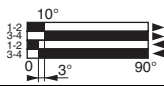
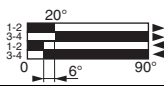
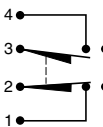
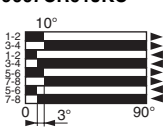
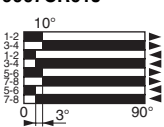
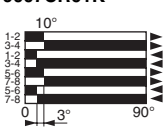
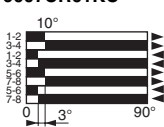
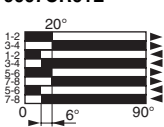
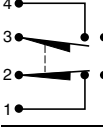
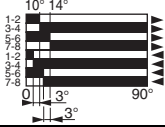
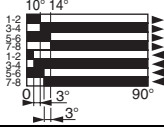
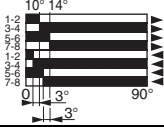
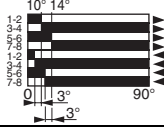
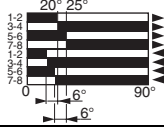

Dimensions:
pages 204 and 205

Limit Switches

9007C Heavy Duty Industrial—Non-Plug-in Body, Metal Hazardous Location

Type of head	Flexible operator (wobble stick)				
Hazardous location non-plug-in body type					
Type of operator	Universal (1)	Wobble stick Delrin® extension (1)	Wobble stick wire extension (1)	Wobble stick coil spring extension (1)	Cat whisker
Catalog numbers					
1 N.O. 1 N.C. snap action 	9007CR53JKC 	9007CR53J 	9007CR53K 	9007CR53KC 	9007CR53L 
2 N.O. 2 N.C. snap action 	9007CR61JKC 	9007CR61J 	9007CR61K 	9007CR61KC 	9007CR61L 
2 N.O. 2 N.C. Two stage snap action 	9007CR65JKC 	9007CR65J 	9007CR65K 	9007CR65KC 	9007CR65L 
Weight, kg (lb)	1.020 (2.25)	1.020 (2.25)	1.020 (2.25)	1.020 (2.25)	1.020 (2.25)
Contact operation	 contact closed  contact open				
Characteristics (nominal operating data)					
Switch actuation	By any moving object from any direction				
Type of actuation					
Pre-travel	10° (any direction)				20°
Pre-travel two-stage	10° (any direction)				20°
First stage	10° (any direction)				20°
First stage to second stage	4°				5°
Total travel	90°				
Differential	3				6°
Reverse overtravel	—				
Operating torque/force 1 pole & 2 pole	3 lb-in (0.34 N•m)				7 oz-in (0.05 N•m)
Terminal wire sizes (Cabling/Screw Clamp)	1 or 2, 12–22 AWG (2.05–0.644 mm ²) wires maximum				
Repeatability (linear travel of cam)	—				
Cable entry	1/2-14 NPT standard, optional M20 x 1.5 mm for ISO cable entry				

1. Wobble stick extensions are available separately for the universal head or as replacements for complete devices (see page 189)

Dimensions:
pages 204 and 205

Limit Switches

9007C Heavy Duty Industrial—Non-Plug-in Body, Metal Hazardous Location—Dimensions

Side Plunger

9007C••F

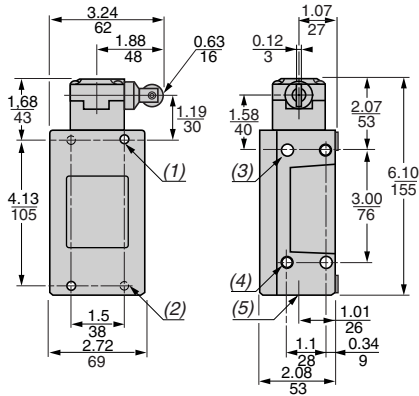

9007C••G

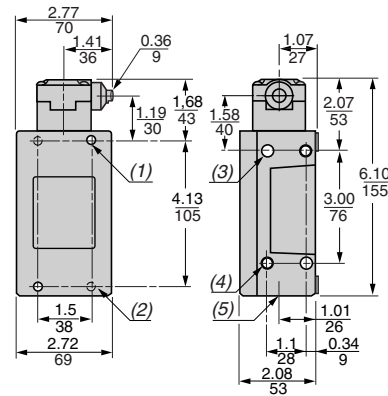

9007C••GD

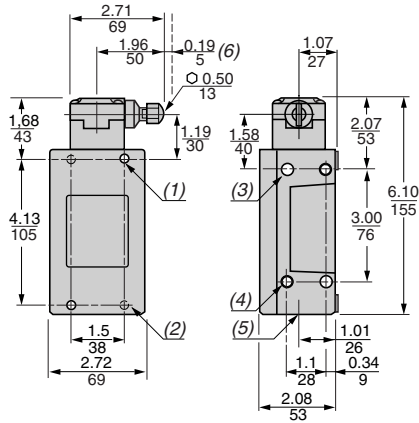

9007C••H

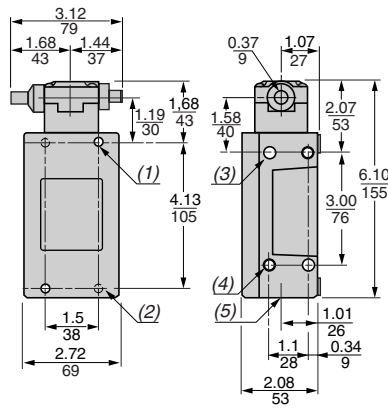

1. 2 x 0.277, front Mtg. holes.
2. 2 x 0.63/16 1/4-20 DP UNC-2B back mounting holes.
3. 2 x 0.26/7 dia. holes.
4. 2 1/4-20 UNC-2B, both sides 0.32/8 DP.
5. 1/2 or 3/4 NPT.
6. Adjustable.

Dual dimensions: $\frac{\text{in.}}{\text{mm}}$

Top Plunger

9007C••D

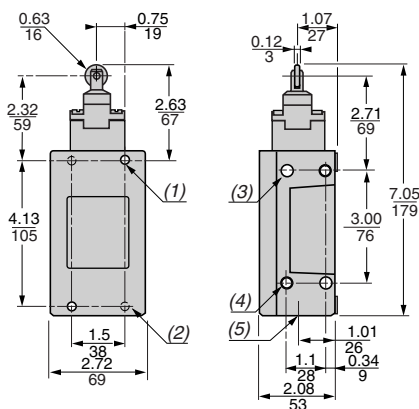

9007C••E

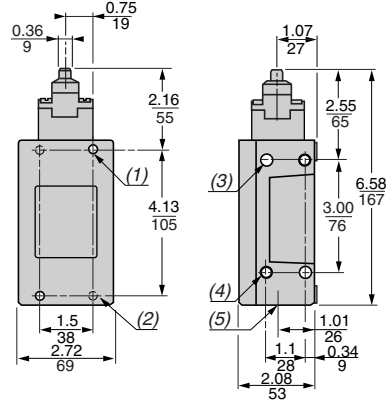

9007C••ED

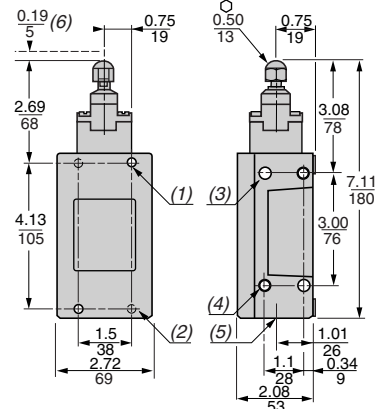

1. 2 x 0.277, front Mtg. holes.
2. 2 x 0.63/16 1/4-20 DP UNC-2B back mounting holes.
3. 2 x 0.26/7 dia. holes, back Mtg. holes.
4. 2 1/4-20 UNC-2B, both sides 0.32/8 DP.
5. 1/2 or 3/4 NPT.
6. Adjustable.

Dual dimensions: $\frac{\text{in.}}{\text{mm}}$

Limit Switches

9007C Heavy Duty Industrial—Non-Plug-in Body, Metal Hazardous Location—Dimensions

Rotary
9007C***

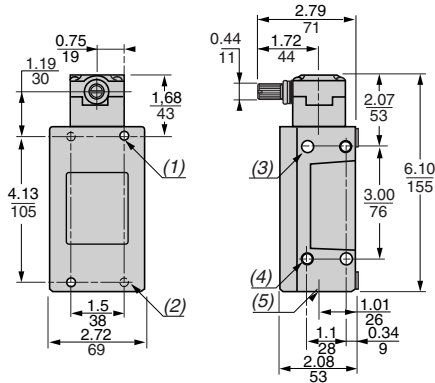

1. 2 x 0.2777, front Mtg holes.
2. 2 x 0.63/16 1/4-20 DP UNC-2B back mounting holes.
3. 2 x 0.2677 dia. holes, back Mtg. holes.
4. 2 1/4-20 UNC-2B, both sides 0.32/8 DP.
5. 1/2 or 1/4 NPT.

Dual dimensions: $\frac{\text{in.}}{\text{mm}}$

Wobble stick
9007C**JKC

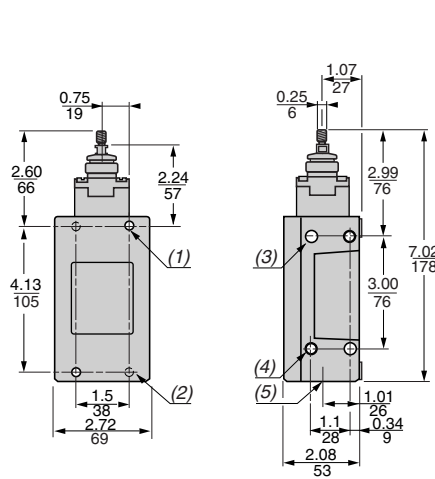

9007C**J

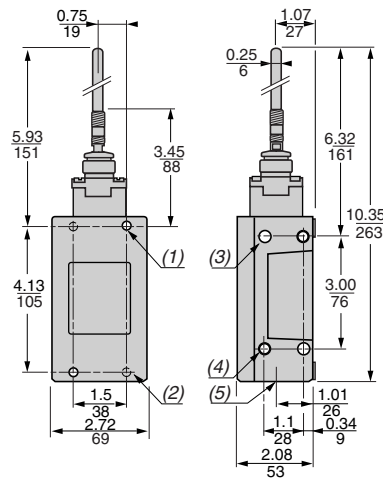

9007C**K

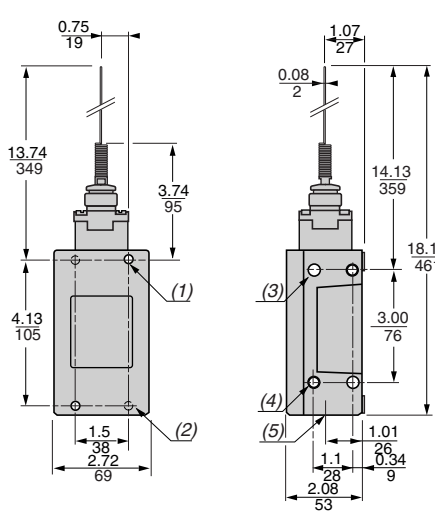

9007C**KC

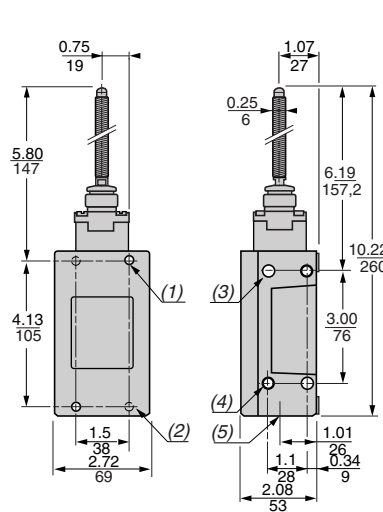

9007C**L

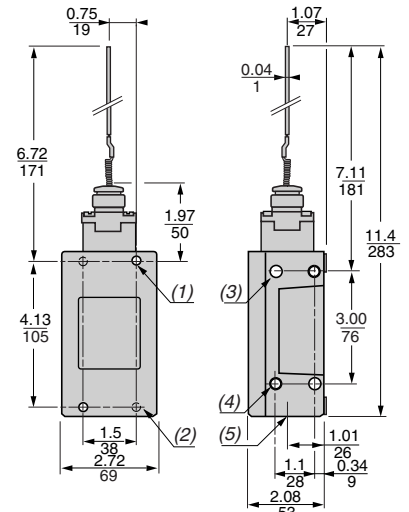

1. 2 x 0.2777, front Mtg holes.
2. 2 x 0.63/16 1/4-20 DP UNC-2B back mounting holes.
3. 2 x 0.2677 dia. holes, back Mtg. holes.
4. 2 1/4-20 UNC-2B, both sides 0.32/8 DP.
5. 1/2 or 1/4 NPT.

Dual dimensions: $\frac{\text{in.}}{\text{mm}}$

Limit Switches

Limit Switches

9007C Heavy Duty Industrial

Technical Information

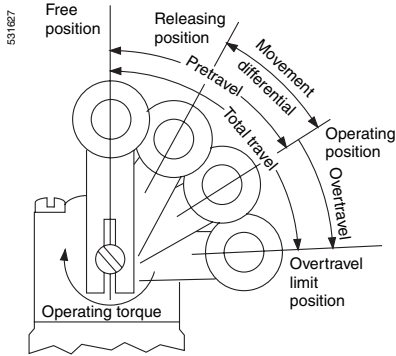

Figure 1: Rotary lever type

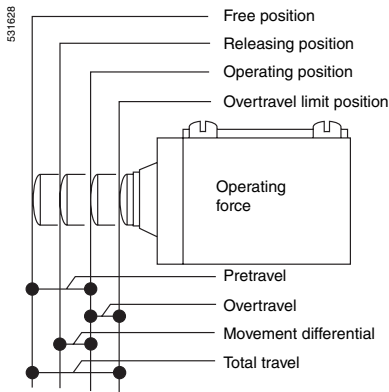

Figure 2: Linear (or Plunger) type

Glossary

CCW—Counterclockwise only (for lever types).

CW—Clockwise only (for lever types).

Differential—The movement differential or differential is the distance or angle from the operating position to the releasing position.

Free or normal position—Free or normal position is the initial position of the actuator when there is no external force (other than gravity) applied on the actuator.

Neutral position—Lever operated switch with a minimum of two contacts. One contact changes state only when lever moves CW. The second contact changes state only when the lever moves CCW. (The center position is the free position.)

Operating position—Operating position is the position of the actuator at which the contacts change state.

Overtravel—Overtravel is the distance or angle through which the actuator moves when traveling from the operating position to the overtravel limit position.

Pre-travel—Pre-travel is the distance or angle through which the actuator moves from the free position to the position at which the contacts change state, the operating position.

Release position—Release position is that position of the actuator at which the contacts change state from the operated contact position to the normal contact position.

Release torque—Release torque is the value to which the torque on the actuator must be reduced to allow the contacts to change state from the operated position to the normal contact position.

Actuator-lever—An actuator is the mechanism of the switch or enclosure which, when moved as intended, will operate the contacts.

Maintained contact limit switch—A maintained contact limit switch is a switch which remains in a given condition until actuated to another condition, which is also maintained until further actuation.

Momentary contact limit switch—A momentary contact limit switch is a switch which returns from the operated condition to its free or normal circuit condition when the actuating force is removed.

N.C.—Normally closed contact, when the switch mechanism is at its free or normal position.

N.O.—Normally open contact, when the switch mechanism is at its free or normal position.

Operating torque—Operating torque (force) is the minimum torque (force) value which must be applied to the actuator to cause the contacts to change state.

Overtravel limit position—Overtravel limit position is that position of the actuator beyond which further overtravel would cause damage to the switch or actuator.

Repeatability—Repeatability is the ability to consistently maintain the original operating characteristics. Measured by the difference between the operating position of a new switch and of the same after 1 million operations.

Total travel—Total travel is the sum of the pre-travel and overtravel.

Travel—Movement of the actuator from its free or normal position when force is applied. (See pre-travel and over travel.)

Limit Switches

9007C Heavy Duty Industrial

Technical Information

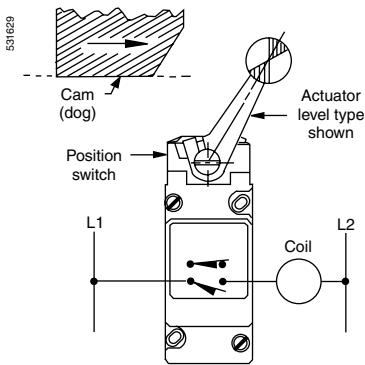

Figure 3—Limit switch

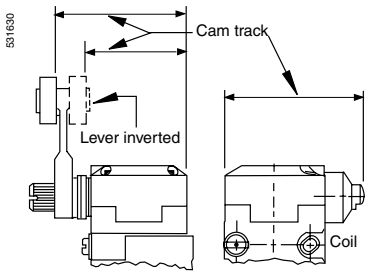

Figure 4—Cam track dimension

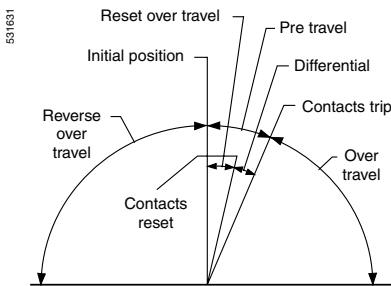

Figure 5—Contact travel

Glossary (continued)

Definition of limit switch terms

There are many terms common to position switches that are not used with other control devices. Before proceeding further, definitions of the commonly used terms should be understood as these terms will be used throughout this document.

Limit switch—A device that converts a mechanical motion into an electrical control signal.

Actuator—The mechanism of a limit switch that operates the contacts, i.e., lever arm, plunger, wobble stick.

Cam—A machine part or component that applies force to the switch actuator causing it to move as intended. Also known as “dog”.

Cam track dimension—The distance from the switch mounting surface to some point on the roller or actuator.

Differential—The distance that the limit switch actuator moves, from the trip point to the reset point of the contacts.

Direct-acting/positive opening contacts—Normally closed contacts that are moved directly by the operating shaft. They are slow make-slow break contacts and have a shorter life than snap action contacts due to longer arcing times. In general, these should only be used where movement of actuator must break welded contacts, as in a crane safety limit switch. (Snap action positive opening contacts are available in the Telemecanique® XCKJ limit switch.)

Maintained contacts—Contacts that remain in the tripped position until the return travel of the cam moves the switch actuator back and resets the contacts.

Neutral (free or normal) position limit switch—A lever arm type switch with two sets of contacts. One set operates when the shaft is rotated clockwise; the other operates when the shaft is rotated counterclockwise.

Operating force—The force required to move limit switch actuator to cause the contacts to change state.

Overtravel—The distance that the position switch actuator may move beyond the trip point, (see figure 5) without damage to the switch.

Pole—The number of moveable contacts in a switching mechanism. A single pole device may be 1 N.O., 1 N.C. or 1 N.O. and 1 N.C. with a single set of moveable contacts is used to bridge those stationary contacts. A double or two pole switch has two moveable contacts.

Positive break contacts—Normally closed contacts with a special mechanism to ensure opening. Can be snap acting positive break or direct acting slow make, slow break type. The slow break direct acting type is not recommended for high cycle applications due to shorter life.

Pre-travel—The distance that the limit switch actuator must move to trip the contacts.

Reed contacts—A mechanism consists of a set of contacts hermetically sealed in a glass envelope and actuated by a magnet attached to the operator. This sealed construction keeps contaminants out of the contact area, making the reed switch ideal for low voltage, low current circuits such as programmable controllers.

Reset point—The position of the actuator at which the contacts return to the normal position.

Snap action contacts—Contacts that move rapidly to open or closed position and are relatively independent of cam speed. Because of shorter arcing times, snap acting contacts have longer contact life than slow make and break contacts and should be used where fast moving cams are encountered or where good repeat accuracy is required.

Spring return—Contacts that return to their original position when the actuating force is removed.

Definition

Slow break contacts—The speed of transfer of the moveable contacts is dependent on the speed of the operator. The amount of travel of the moveable contacts is also dependent on the amount of travel by the operator. Slow make and break contacts have the same trip and reset points, and do not have the differential travel common to snap switches.

Snap action contacts—The speed of transfer of the moveable contacts is not dependent on the speed of the operator. The amount of travel of the moveable contacts is also not dependent on the amount of travel by the operator. The movement of the moveable contacts are determined by a preset travel, after this point is reached, the contacts will trip. Snap action contacts have different trip and reset points, the difference is identified as “differential.”

Flexible operators—Flexible resilient or elastic operators, i.e., wobble sticks, do not ensure direct opening/positive opening action.

Isolated contacts—Single-pole double-throw (SPDT) contacts with four terminals which have two isolated contact bars mechanically linked. No polarity restrictions apply. Different (isolated) power supplies can also be applied.

Same polarity—Single-pole double throw (SPDT) contacts with four terminals that require the supply to be applied with the same polarity (i.e., L1 or +) on the same side of the contact bar. Two different supplies are not allowed in this configuration. (The loads should always be on the same side of the contact bar.)

Direct opening contact (also known as positive opening contacts)—A normally closed contact element coupled with the switch actuator via a non-resilient (non-elastic) member so that full contact opening is obtained when the actuator is moved through the direct opening travel by applying a direct opening force. The contact element will shear open in the event of sticking contacts or broken springs. Proper fusing of the control circuit is required. Direct opening contacts meet IEC 60947-5-1 requirements.

Direct opening travel (also known as positive opening travel)—Minimum travel from the actuator free position to the position where the direct opening operation is completed. Usually longer than the normal pre-travel.

Reed contacts—Contact mechanism consists of a set of contacts hermetically sealed in a glass envelope and actuated by a magnet attached to the operator. This sealed construction keeps contaminants out of the contact area, making the reed switch the ideal switch for low voltage, low current circuits such as programmable controllers.

NOTE: Because reed switches are operated by a magnet, they should not be installed in areas where strong magnetic fields may be present. The devices should always be checked for proper operation after installation.

Polarity

Opposite polarities should not be connected to the contacts of one limit switch unless the limit switch is specifically designed for such service (isolated contacts—no polarity). See page 209.

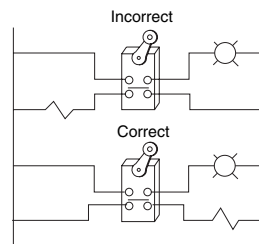

Power sources

Power from different sources should not be connected to the contacts of one limit switch unless the switch is specifically designed for such service (isolated contacts—no polarity).

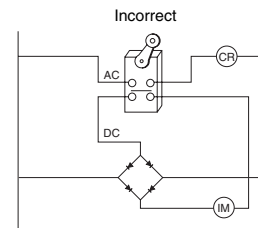

Limit Switches

9007C Heavy Duty Industrial

Technical Information

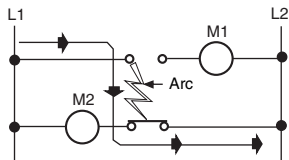
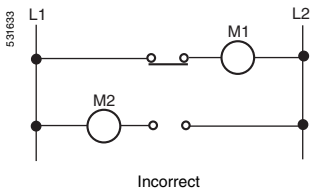
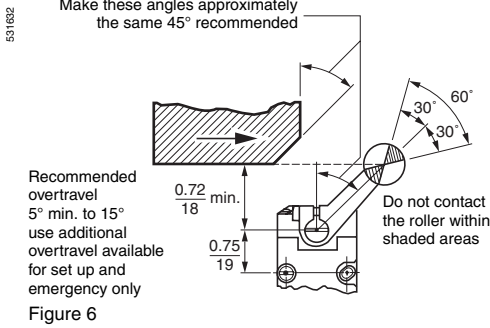

Figure 7—Contacts connected to opposite polarities. Line to line short (bold line) can occur through arc drawn when contacts operate

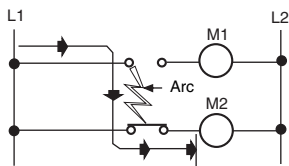
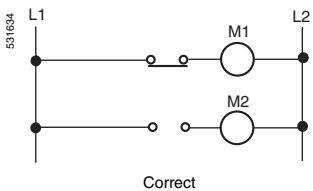

Figure 8—Contacts connected to same polarity. Line to line short cannot occur when contacts operate

Overriding Cams

The cam trailing edge on overriding cams must also be considered for maximum switch life (see figure 6). Lever arm snap back causes shock loads which reduce switch life. Also, with reversing cams the trailing edge becomes a leading edge on the return stroke. The overtravel of the limit switch should not be exceeded, but 5° minimum to 15° travel past the trip point is recommended. Additional travel should only be used for set up and emergencies. Cam design procedures for limit switches with other than lever arm actuators vary from switch type to switch type and are discussed along with other limit switch application design suggestions in additional literature "Proper Application of Limit Switches" (SM444).

Contacts

- Make sure the electrical load is within limit switch contact ratings.
- The single pole, double throw contacts of a snap switch used in a limit switch should not be used on opposite polarities. When load M1 is connected between the contact and line L2, and load M2 is connected between the other contact and line L1 (figure 7), a line-to-line short (bold line) can occur through the arc, which may be drawn as the contacts operate. When contacts are connected to the same polarity (figure 8), this line-to-line short cannot occur.
- The same result can occur if different power sources are connected to the single-pole, double-throw contacts of a snap switch.
- With limit switches having reed contacts, some form of transient protection should be used. This protects the small contacts from damaging surges and increases contact life.

Coolant

- When possible, avoid mounting limit switches where they will be constantly exposed to coolant, chips, etc. Although designed for such applications, switches last longer when not exposed to these contaminants.
- Make sure cover screws are tightened to ensure a good oiltight seal.
- When possible, avoid using fire-resistant coolants of the phosphate ester type. Equipment exposed to these coolants requires special seals and gaskets. Viton® fluoroelastomer, resistant to these types of coolants, is the standard shaft seal material on Type C lever arm types. If required, all gaskets, as well as boots on plunger types, can be furnished in Viton material.

Recommendations for Conduit Installation

Limit switch leakage is often traced to the conduit system. Coolant or condensation in the conduit line can enter the switch through the conduit entry. Oil tightness depends on the condition of the conduit connection and seal. Recommendations for installing conduit to position switches are as follows:

- To ensure an oiltight seal, use thread sealant and a conduit seal or a sealing bushing around the conduit fitting. Otherwise, the fitting probably will leak.
- Limit switches should be installed with the conduit end down whenever possible.
- If condensation or moisture is present inside the conduit, a Square D® conduit seal can be inserted into the conduit entry. The conduit fitting can then be connected in the normal manner. Thread sealant and a sealing bushing must still be used.
- Often a junction box fills with coolant and/or condensation, which backs up into the position limit through the conduit. A simple solution is to drill a hole in the bottom of the junction box to allow the liquid to drain out.
- If conduit leakage is severe, pre-wired and potted position limit (Forms Y184• and Y185•) should be used. The switches are pre-wired with either individual wires or multiconductor STOWA cord, and the receptacle is sealed with a potting material.
- The Square D limit switch is available with a pre-wired male plug receptacle. The connector provides an effective oiltight seal when used with the appropriate female connector cord.

Limit Switches

9007C Heavy Duty Industrial

Technical Information

Terminal Identification

European (IEC) contact terminals marking

Single pole	Double pole	
	1 st pole	2 nd pole
11-12	11-12	21-22
13-14	13-14	23-24
11-12	11-12	21-22
13-14	13-14	23-24

Each terminal is marked with 2 digits: First digit indicates the pole (circuit). The second digit indicates the type of contact:

_1-2 is N.C., _3-4 is N.O.

i.e.: 11-12, 21-22 are N.C. 13-14, 23-24 are N.O.

Example of European Terminal Markings:

For switch elements without isolated contacts:

11-12 Is the N.C. contact of pole No. 1, 13-14 Is the N.O. contact of pole No. 2

For switch elements with isolated contacts:

13-14 Is the N.O. contact of pole No. 1, 21-22 Is the N.C. contact of pole No. 2

Example of US Terminal Markings

Single pole	Double pole	
	1 st pole	2 nd pole
1-2	1-2	5-6
3-4	3-4	7-8
1-2	1-2	5-6
3-4	3-4	7-8

Each contact terminal is marked with one digit, i.e., 1-2, 3-4, 5-6,7-8.

Example of US Terminal Markings:

For most snap switch elements (isolated contacts not usually on US manufactured switches):

1-2 is the N.C. contact of pole No. 1,

3-4 is the N.O. contact of pole No. 1

5-6 is the N.C. contact of pole No. 2,

7-8 is the N.O. contact of pole No. 2

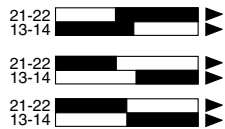

Make-before-break (overlapping) SPDT: the normally open contact closes before the normally closed contact opens.

Break-before-make (offset) SPDT: the normally closed contact opens before the normally open contact closes.

Simultaneous make and break SPDT: the normally closed contact opens at the same time as the normally open contact closes.

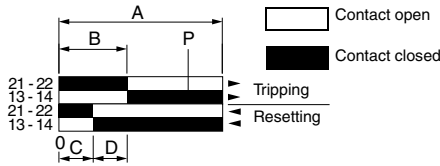

A = Maximum travel of the operator in mm or degrees.

B = Tripping travel of the contact.

C = Resetting travel of contact.

D = B-C = Differential travel.

P = Point from which positive opening is assured.

NOTE: The arrows indicate direction of actuation clockwise (CW) and return for simplicity reasons. For counterclockwise (CCW) only direction of actuation is reversed.

Wiring diagrams

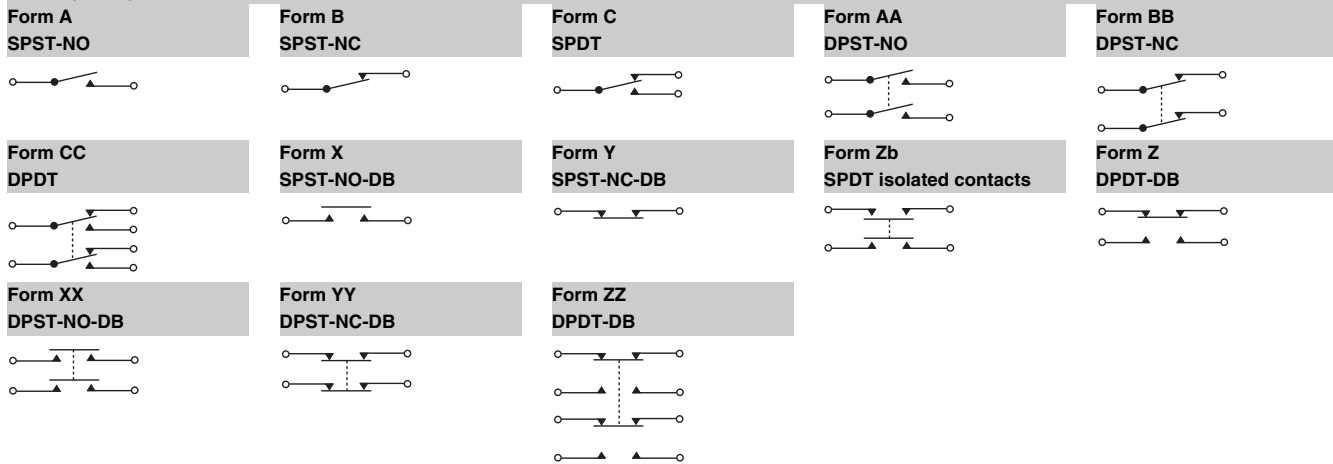

Limit Switches

9007C Heavy Duty Industrial Cam Design

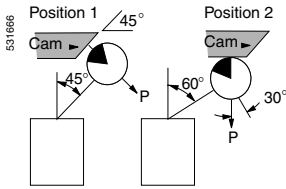

Figure 1A cam design for speeds up to 50 fpm

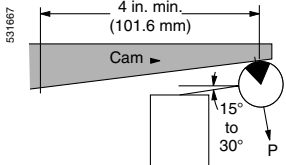

Figure 1B cam design for speeds from 50 to 200 fpm (15.2 to 60.9 mpm).

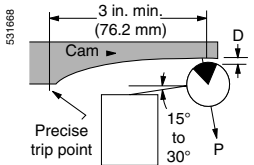

Figure 1C cam design for speeds from 200 to 400 fpm (60.9 to 121.9 mpm).

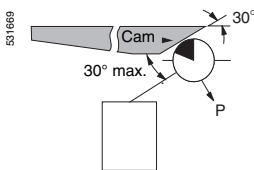

Figure 2

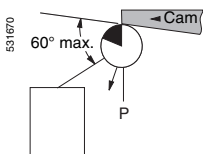

Figure 3

Application information

Excessive impact from improperly designed actuating systems is without question the leading cause of premature failure of the electromechanical limit switch. At slow speed, impact is rarely troublesome, but as speed increases, impact applied to the switch becomes a critical problem. In today's higher speed machines, therefore, it is important to give proper consideration to correctly designed actuating systems. These recommendations are designed to assist you in obtaining greater life from your limit switches. The black sector in the roller indicates the recommended design limits of the angle of pressure shown in the illustrations as "P". Three main design and installation considerations are:

- The pressure applied by the actuating mechanism to switch operating lever should approximate direction of lever rotation with a variation not to exceed 30°.
- Since the angle of pressure changes drastically with rotation of the lever, the cam must be designed for proper pressure angles at all positions of the lever travel.
- The switch operating levers should be positioned as nearly parallel with the leading edges of the cams as possible.

Considering these three factors:

- The cam in Figure 1A is satisfactory for speeds up to 50 fpm (15.2 mpm)
- The cam in Figure 1B is suitable for speeds up to 200 fpm (60.9 mpm) (nonuniform acceleration of switch lever)
- The cam in Figure 1C is satisfactory for speeds up to 400 fpm (121.9 mpm) (uniform or other controlled acceleration)

Designing proper pressure angles for overriding cams for electromechanical limit switches

Don't underestimate the importance of adjusting the cams and operating levers in electromechanical limit switches to provide the proper pressure angles in every travel position. Without the means to control the angle of pressure or the limit of override, the operating lever may spring back with damaging results. *Lever flyback usually causes double pulsing of the contacts, and places additional stresses on the mechanical system of the limit switch.* The excessive impacts absorbed from inadequately designed actuating devices eventually leads to abnormal wear and premature failure of the limit switch.

By looking closely at the actuating angles of the cam surface, designers and engineers can obtain the maximum operating life from electromechanical limit switches. The following recommendations help provide a workable knowledge of proper lever and cam angles—and how they are applied to secure optimum conditions:

- Actuating cam on machinery or slide should provide a trailing edge so that upon overriding the operating lever will not snap back.
- During the approach phase, **the pressure angle of the cam should not vary from the lever angle more than 30°.**
- On the override phase, **the angle of the trailing edge of the cam to the lever should be no more than 60°.**

If these guidelines are followed, the switch operating levers will always be approximately parallel with the leading edges of the actuating surfaces or cams.

Figure 2 shows leading edge of cam about to depress and actuate the electromechanical limit switch. The black sector of the roller indicates the recommended design limits of the angle of pressure shown in drawings as "P".

Figure 3 shows operating lever roller following the trailing edge of the cam on the override cycle. Unless a one-way lever is used, the cam will operate the switch on the return cycle.

Limit Switches

9007C Heavy Duty Industrial

Linear/Angular Lever Travel

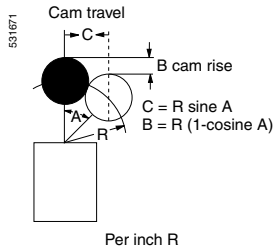

Application information (continued)

The table below can assist the designer of machine tools and conveyors, the plant engineer, or the maintenance personnel responsible for keeping this equipment in a satisfactory operating condition.

The design engineer will find the table useful in making trouble-free cam layouts. For example, if the recommended operating travel for a switch is between 15° and 30°, use the table to figure cam rise and travel. This aids in determining what type of cam to design, its dimensions, etc.

The plant engineer can use the table to determine where to position levers on replacement switches or revamped circuitry to operate existing cams. The engineer can also use the table to position the lever in proper relationship to the cam, and to find out whether switches and cams are installed properly to obtain maximum switch life.

All dimensions in the table are for 1 in. (25.4 mm) levers. If you use longer levers, multiply the figures by the increased lever length. For example, for a 2 in. (50.8 mm) lever, use the multiplier 2.

All limit switches have a recommended operating travel and for best performance should be installed within these limits. (1)

Dual dimensions: in. (mm)

A	B	C	A	B	C
1°	0.0002 (0.005 mm)	0.017 (0.43 mm)	46°	0.305 (7.7 mm)	0.719 (18.2 mm)
2°	0.0006 (0.015 mm)	0.035 (0.89 mm)	47°	0.318 (8.1 mm)	0.731 (18.6 mm)
3°	0.0014 (0.035 mm)	0.052 (1.3 mm)	48°	0.331 (8.4 mm)	0.743 (18.9 mm)
4°	0.002 (0.05 mm)	0.070 (1.8 mm)	49°	0.344 (8.7 mm)	0.755 (19.2 mm)
5°	0.004 (0.101 mm)	0.087 (2.2 mm)	50°	0.357 (9.0 mm)	0.766 (19.4 mm)
6°	0.005 (0.127 mm)	0.105 (2.6 mm)	51°	0.371 (9.4 mm)	0.777 (19.7 mm)
7°	0.007 (0.178 mm)	0.122 (3.1 mm)	52°	0.384 (9.7 mm)	0.788 (20.0 mm)
8°	0.010 (0.254 mm)	0.139 (3.5 mm)	53°	0.398 (10.1 mm)	0.799 (20.3 mm)
9°	0.012 (0.304 mm)	0.156 (4.0 mm)	54°	0.412 (10.4 mm)	0.809 (20.5 mm)
10°	0.015 (0.381 mm)	0.174 (4.4 mm)	55°	0.426 (11.0 mm)	0.819 (20.8 mm)
11°	0.018 (0.457 mm)	0.191 (4.8 mm)	56°	0.441 (11.2 mm)	0.829 (21.0 mm)
12°	0.022 (0.559 mm)	0.208 (5.3 mm)	57°	0.455 (11.5 mm)	0.839 (21.3 mm)
13°	0.026 (0.660 mm)	0.225 (5.7 mm)	58°	0.468 (12.3 mm)	0.857 (21.7 mm)
14°	0.030 (0.762 mm)	0.242 (6.1 mm)	59°	0.485 (12.3 mm)	0.857 (21.7 mm)
15°	0.034 (0.863 mm)	0.259 (6.6 mm)	60°	0.500 (12.7 mm)	0.866 (22 mm)
16°	0.039 (0.990 mm)	0.276 (7.2 mm)	61°	0.515 (13.1 mm)	0.875 (22.2 mm)
17°	0.044 (1.12 mm)	0.292 (7.4 mm)	62°	0.531 (13.5 mm)	0.883 (22.4 mm)
18°	0.049 (1.24 mm)	0.309 (7.8 mm)	63°	0.546 (14.0 mm)	0.891 (22.6 mm)
19°	0.054 (1.37 mm)	0.326 (8.3 mm)	64°	0.562 (14.3 mm)	0.899 (22.8 mm)
20°	0.060 (1.52 mm)	0.342 (8.7 mm)	65°	0.577 (14.6 mm)	0.906 (23.0 mm)
21°	0.066 (1.67 mm)	0.358 (9.1 mm)	66°	0.593 15.0 (mm)	0.914 (23.2 mm)
22°	0.073 (1.85 mm)	0.375 (9.5 mm)	67°	0.609 15.5 (mm)	0.921 (23.4 mm)
23°	0.079 (2.00 mm)	0.391 (9.9 mm)	68°	0.625 (16.0 mm)	0.927 (23.5 mm)
24°	0.086 (2.2 mm)	0.407 (10.3 mm)	69°	0.642 (16.3 mm)	0.934 (23.7 mm)
25°	0.094 (2.38 mm)	0.423 (10.7 mm)	70°	0.658 (16.7 mm)	0.940 (23.9 mm)
26°	0.101 (2.56 mm)	0.438 (11.1 mm)	71°	0.674 (17.1 mm)	0.946 (24.0 mm)
27°	0.109 (2.77 mm)	0.454 (11.5 mm)	72°	0.691 (17.5 mm)	0.951 (24.1 mm)
28°	0.117 (2.9 mm)	0.469 (12 mm)	73°	0.708 (18.0 mm)	0.956 (24.3 mm)
29°	0.125 (3.17 mm)	0.485 (12.3 mm)	74°	0.724 (18.4 mm)	0.961 (24.4 mm)
30°	0.134 (3.40 mm)	0.500 (12.7 mm)	75°	0.741 (19.0 mm)	0.966 (24.5 mm)
31°	0.143 (3.6 mm)	0.515 (13.1 mm)	76°	0.758 (19.2 mm)	0.970 (24.6 mm)
32°	0.152 (3.9 mm)	0.530 (13.4 mm)	77°	0.775 (20.0 mm)	0.974 (24.7 mm)
33°	0.161 (4.1 mm)	0.545 (14.0 mm)	78°	0.792 (20.1 mm)	0.978 (24.8 mm)
34°	0.171 (4.3 mm)	0.559 (14.2 mm)	79°	0.809 (20.5 mm)	0.982 (24.9 mm)
35°	0.181 (4.6 mm)	0.574 (14.6 mm)	80°	0.826 (21.0 mm)	0.985 (25.0 mm)
36°	0.191 (4.8 mm)	0.588 (15 mm)	81°	0.844 (21.4 mm)	0.988 (25.1 mm)
37°	0.201 (5.1 mm)	0.602 (15.3 mm)	82°	0.861 (21.8 mm)	0.990 (25.1 mm)
38°	0.212 (5.4 mm)	0.616 (15.6 mm)	83°	0.878 (22.3 mm)	0.993 (25.2 mm)
39°	0.223 (5.7 mm)	0.629 (16.0 mm)	84°	0.895 (22.7 mm)	0.995 (25.3 mm)
40°	0.234 (6.0 mm)	0.643 (16.3 mm)	85°	0.913 (23.2 mm)	0.996 (25.3 mm)
41°	0.245 (6.2 mm)	0.656 (16.6 mm)	86°	0.930 (23.6 mm)	0.9976 (25.3 mm)
42°	0.257 (6.5 mm)	0.669 (17.0 mm)	87°	0.948 (24.0 mm)	0.9986 (25.4 mm)
43°	0.269 (6.8 mm)	0.682 (17.3 mm)	88°	0.965 (24.5 mm)	0.9994 (25.4 mm)
44°	0.281 (7.1 mm)	0.695 (17.6 mm)	89°	0.983 (25.0 mm)	0.9999 (25.4 mm)
45°	0.293 (7.4 mm)	0.707 (18 mm)	90°	1.000 (25.4 mm)	1.000 (25.4 mm)

1. Refer to document SM444R1 for additional information regarding Cam speed and angles.

Limit Switches

9007C Heavy Duty Industrial

Installation Considerations

Lever Actuators

For limit switches with lever actuators, the actuating force should be applied as nearly perpendicular to the lever as practical and perpendicular to the shaft axis about which the lever rotates.

Lever Actuators

Correct

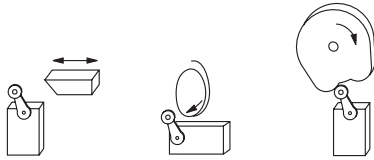

Incorrect

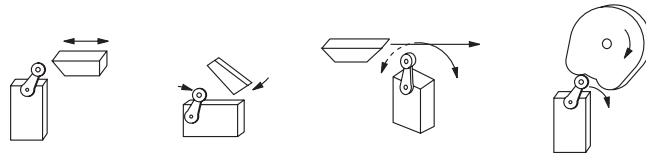

Dwelling Requirements

Where relatively fast motions are involved, the cams should be so designed that the limit switch will be held operated long enough to operate relays, valves, etc.

Correct

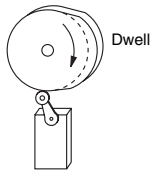

Incorrect

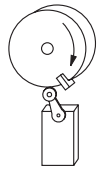

Overtravel limitations

Operating mechanisms for limit switches should be so designed that, under any operating or emergency conditions, the limit switch is not operated beyond its overtravel limit position. A limit switch should not be used as a mechanical stop.

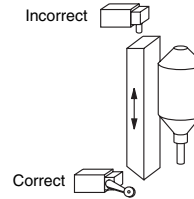
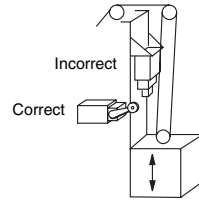

Correct

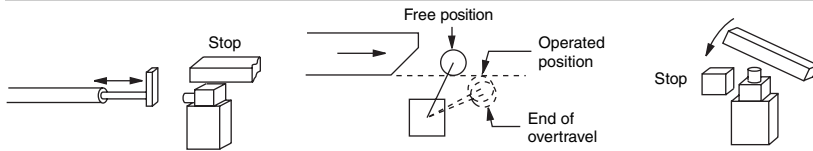

Limit Switches

9007T and FT Severe Duty Mill and Foundry Switches

Conforming to NEMA A600 and UL508

Description

9007T Mill Switches

Use the 9007T Mill switches instead of other limit switches in the following applications:

- Where the current load exceeds the typical heavy duty limit switch contact rating of 10 A and falls within the range of up to 20 A continuous.
- Where an operating sequence is required that is not possible on other limit switches. Fifteen sequences are available. Universal type has twelve different operating sequences with CW only, CCW only and neutral position. Standard type has three operating sequences with CW and CCW operation.
- Where higher reset forces are required due to foreign material interfering with lever arm operation, or where long heavy arms must reset against gravity.

9007FT Foundry Switches

The 9007FT Foundry switches are for use in foundries or mills where the applications described above are required, and where falling foundry sand or similar material could build up and jam the operating mechanism. The shaft has a dust boot and extends from the switch case, preventing sand build up around the shaft. The devices can withstand hot falling sand up to 300° F (149° C.).

9007 (convertible sequence)

9007T Mill Switches

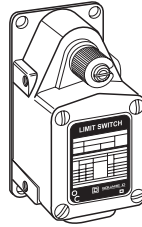

Page 216

9007FT Foundry Switches

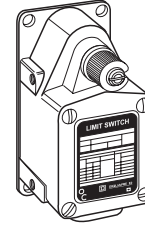

Page 218

Application Information

Type T — Ideal for applications requiring extra heavy duty contact ratings, or higher operating and reset forces. Rugged mechanical construction with several different operating sequences in one basic switch.

Type FT — Designed specifically for rough foundry application. The shaft is entirely beyond the switch case to prevent jamming of the lever arm due to build up of sand. A dust boot is furnished as standard to further prevent sand packing and allow free movement of the lever arm. An extra long shaft bearing makes the switch extremely rugged and able to handle the rough applications encountered in foundries, mills, machine tool and similar industries. The switch will withstand hot falling sand up to 300° F (149° C).

Type T and FT

Enclosure — Oil-tight, dust-tight, water-tight, drip-tight meets NEMA Types 2, 4, and 13 requirements. Die cast zinc construction.

Operating Sequences — Fifteen sequences available. Universal type has 12 different operating sequences with CW only, CCW only, and neutral position operation. Standard type has three operating sequences with CW and CCW operation. Various sequences will give quick make and break, spring return with maintained contact, or slow make and break. Most sequences are convertible by removing the base plate and adjusting the positioning plate and/or latches

Ambient Temperature Range — 10° F (-12.2° C) to 185° F (85° C) ambient at full rated load, up to 220° F (104° C) ambient with single coil load.

Lever Arm — Die cast zinc construction with hardened, oil-impregnated, sintered iron rollers.

Conduit — 0.5 in. standard / 20 mm optional—Form M11

Mounting — Four baseplates provide end or side mounting holes and/or manifold mounting. All mounting holes are 0.25 in. (6.35 mm) diameter. Two tapped holes on each side of switch allows side mounting.

Contacts — SPDT¹ double break and three point double throw single break. Silver contact tips. Phenolic contact block. Nylon liner. Polarity must be the same on double throw contacts.

1. Single pole, double throw.

Interpretation of Catalog Numbers:
page 239

Limit Switches

9007T and FT Severe Duty Mill and Foundry Switches

Conforming to NEMA A600 and UL508

Environmental characteristics	
Conforming to standards	UL508
Product certifications	UL Listed, CSA Certified, CE Marked
Protective treatment	Corrosion resistant gray paint
Ambient air temperature	-10 to +185 °F (-23 to +85 °C) Housing can withstand falling sand at +300 °F (+149 °C)
Vibration resistance	10G (10–55 Hz)
Shock resistance	30G
Electric shock protection	Class O
Degree of protection	NEMA Types 1, 2, 4, 12, 13, IP65, 66, 67
Cable entry or connector	1/2" NPT (metric available)
Materials	Cast zinc

Contact block characteristics	
Rated operational characteristics hard contacts AC Voltage	NEMA A600 Ithe = 20 A 20 A Resistive and continuous
Rated operational characteristics hard contacts DC Voltage	NEMA P 600 Ithe = 20 A 20 A Resistive and continuous
Rated insulation voltage	600 V
Rated impulse withstand voltage	2,500 Vac for 1 minute for CE, 2,200 Vac for 1 minute for UL, and 2,640 Vac for 1 minute for CSA
Positive opening	No
Short circuit protection	20 A Bussmann Class CC KTK-R-20 fuse, non-time-delay
Terminal wire sizes (Cabling/Screw Clamp)	12 – 22 AWG (3.31 mm ² – 0.326 mm ²) wire max.
Maximum actuation speed	15.2 mpm / 27.4 mpm (50 fpm / 90 fpm) with 45 ° Cam angle, levers only

Maximum current ratings for control circuit contacts												
Contacts	AC							DC				
	Volts	Inductive 35% Power Factor				Continuous Carrying Amperes	Resistive 75% Power Factor		Volts	Inductive and Resistive		Continuous Carrying Amperes
		Make Amperes		Break VA			Make, Break and Continuous Carrying Amperes			Make and Break Amperes	Continuous Carrying Amperes	
			VA	Amperes	VA				Single Throw	Double Throw		
SPDT Quick Make and Break	120	150	18,000	20	2400	20	20	120	5.0	9	20	
	240	75	18,000	12.5	3000	20	20	250	1.0	9	20	
	480	37.5	18,000	6.25	3000	20	20	600	0.2	9	20	
	600	30	18,000	5	3000	20	20					
All Slow Make and Break	120	60	7200	6	720	20	10 20	9	9	9	9	
	240	30	7200	3	720	20	10 20	9	9	9	9	
	480	15	7200	1.5	720	20	10 20	9	9	9	9	
	600	12	7200	1.2	720	20	10 20	9	9	9	9	

Characteristics for material and ratings comparisons — standard switches		
	9007 Type T/FT	Type L (R. B. Denison Lox Switch)
Body material	Cast zinc	Cast aluminum
Cover material	Cast zinc	Aluminum
Base plate material	Steel with zinc plating	Steel with chromate plating
Shaft seal material	Nitrile	PVC
Contact block material	Phenolic	Glass filled nylon
Moveable contact material	Fine silver on copper backing	Coin Silver on steel backing
Stationary contact material	Fine silver on copper backing	90/10 AgCdO on copper backing
Low ambient temperature rating	-10° F	0° F
High ambient temperature at full rating	180° F	200° F
Enclosure rating	NEMA Types 1, 2, 4, 12 and 13	NEMA Types 1, 4 and 13
Vibration resistance	10G (10–150 Hz)	40G max (10-150 Hz)

♦ Many switches are available with higher or lower temperature limits by selecting special versions or special options. See page 237.

Limit Switches

9007T Severe Duty Mill Switches

Universal Operating Sequences

Universal Catalog Numbers

Base Plate

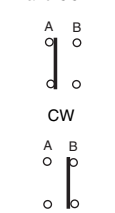
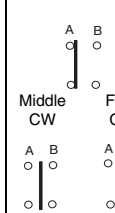
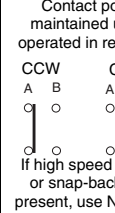
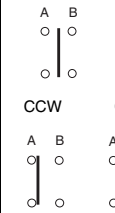
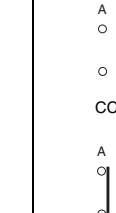
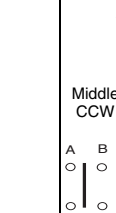





Surface Mounted	A	9007TUA1	9007TUA2	9007TUA3	9007TUA4	9007TUA5	9007TUA6
	B	9007TUB1	9007TUB2	9007TUB3	9007TUB4	9007TUB5	9007TUB6
	C	9007TUC1	9007TUC2	9007TUC3	9007TUC4	9007TUC5	9007TUC6
	D	9007TUD1	9007TUD2	9007TUD3	9007TUD4	9007TUD5	9007TUD6
		No. 1	No. 2	No. 3 ④	No. 4	No. 5	No. 6
		SPDT Spring Return CW Only	SPDT Spring Return CW Only	SPDT Maintained Contact	SPDT Spring Return Neutral Position	SPDT Spring Return CCW Only	SPDT Spring Return CCW Only
		Initial position and CCW 	Initial position and CCW 	Spring return of arm to initial pos. Contact pos. maintained until operated in reverse CCW CW 	Initial position 	Initial position and CW 	Initial position and CW 

Characteristics

Nominal Operating Data

Pre-travel ①	14°	Int. Pos. 9°, Final 16°	7°	6°	14°	Int. Pos. 9°, Final 16°
Total travel	88°	88°	81°	81°	88°	88°
Differential	12°	5°	7°	5°	12°	5°
Operating torque	12 lb-in (1.35 N•m)	12 lb-in (1.35 N•m)	12 lb-in (1.35 N•m)	12 lb-in (1.35 N•m)	12 lb-in (1.35 N•m)	12 lb-in (1.35 N•m)
Repeat accuracy ②	± 0.004 in. (0.10 mm)	± 0.004 in. (0.10 mm)	± 0.004 in. (0.10 mm)	± 0.004 in. (0.10 mm)	± 0.004 in. (0.10 mm)	± 0.004 in. (0.10 mm)

To convert sequences, remove base plate, position plate and latches. Reassemble positioning plate and latches as shown.

						
Weight lb (kg)	2.35 lb. (1.07 kg)	2.35 lb. (1.07 kg)	2.35 lb. (1.07 kg)	2.35 lb. (1.07 kg)	2.35 lb. (1.07 kg)	2.35 lb. (1.07 kg)

Universal Catalog Numbers (continued)

Base Plate

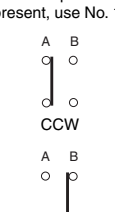
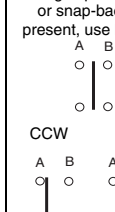
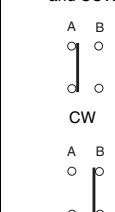
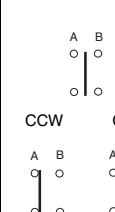
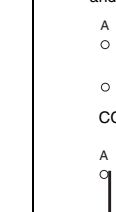
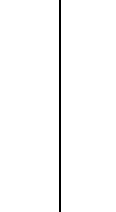



Surface Mounted	A	9007TUA7	9007TUA8	9007TUA9	9007TUA10	9007TUA11	9007TUA12
	B	9007TUB7	9007TUB8	9007TUB9	9007TUB10	9007TUB11	9007TUB12
	C	9007TUC7	9007TUC8	9007TUC9	9007TUC10	9007TUC11	9007TUC12
	D	9007TUD7	9007TUD8	9007TUD9	9007TUD10	9007TUD11	9007TUD12
		No. 7	No. 8 ④	No. 9	No. 10	No. 11	No. 12
		SPDT Maintained	SPDT Maintained Neutral Position	SPDT Spring Return Slow Make, Slow Break	SPDT Spring Return Slow Make, Slow Break	SPDT Spring Return Slow Mak, Slow Break	SPDT Maintained
		If high speed cam or snap-back present, use No. 12 	Initial position If high speed cam or snap-back is present, use No. 12 	Initial position and CCW 	Initial position 	Initial position and CW 	CCW 

Characteristics

Nominal Operating Data

Pre-travel ①	10°	6°	12°	3°	12°	45°
Total travel	85°	81°	87°	81°	87°	90°
Differential	12°	10°	0°	0°	0°	0°
Operating torque	2.5 lb-in (0.28 N•m)	2.5 lb-in (0.28 N•m)	12 lb-in (1.35 N•m)	12 lb-in (1.35 N•m)	12 lb-in (1.35 N•m)	8 lb-in (0.9 N•m)
Repeat accuracy ②	± 0.004 in. (0.10 mm)	± 0.004 in. (0.10 mm)	± 0.004 in. (0.10 mm)	± 0.004 in. (0.10 mm)	± 0.004 in. (0.10 mm)	± 0.004 in. (0.10 mm)

To convert sequences, remove base plate, position plate and latches. Reassemble positioning plate and latches as shown.

						Not adjustable
Weight lb (kg)	2.35 lb. (1.07 kg)	2.35 lb. (1.07 kg)	2.35 lb. (1.07 kg)	2.35 lb. (1.07 kg)	2.35 lb. (1.07 kg)	2.35 lb. (1.07 kg)

Footnotes: see page 217

Dimensions:
pages 222 to 225

Interpretation of Catalog Numbers:
page 239

Base Plates:
pages 221 and 222

Limit Switches

9007T Severe Duty Mill Switches

Standard Operating Sequences

Standard Catalog Numbers

Base Plate

Surface
Mounted

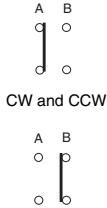
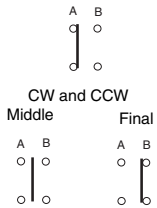
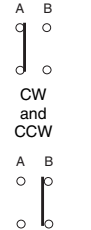

A	9007TSA1	9007TSA2	9007TSA3
B	9007TSB1	9007TSB2	9007TSB3
C	9007TSC1	9007TSC2	9007TSC3
D	9007TSD1	9007TSD2	9007TSD3
	No. 1	No. 2	No. 3
	SPDT Spring Return CW & CCW	SPDT Spring Return CW & CCW	SPDT Spring Return CW & CCW Slow Make, Slow Break
	Initial position 	Initial position 	Initial position 

Characteristics (nominal operating data)

Switch actuation	By 30° cam		
Type of actuation			
Pre-travel ①	14°	Int. Pos. 9°, Final 16°	9°
Total travel	89°	89°	89°
Differential	12°	Int. Pos. 5.5°, Final 7.5°	5°
Reverse overtravel	N/A (future availability)	N/A (future availability)	N/A (future availability)
Operating torque/force 1 pole & 2 pole	10 lb-in (1.13 N•m)	10 lb-in (1.13 N•m)	10 lb-in (1.13 N•m)
Terminal wire sizes (Cabling/Screw Clamp)	#12–22 AWG (3.31–0.326 mm ²)	#12–22 AWG (3.31–0.326 mm ²)	#12–22 AWG (3.31–0.326 mm ²)
Repeatability ② (linear travel of cam)	± 0.004 in. (0.10 mm)	± 0.004 in. (0.10 mm)	± 0.004 in. (0.10 mm)
Cable entry (metric available)	1/2" NPT	1/2" NPT	1/2" NPT
Weight lb (kg)	2.35 lb. (1.07 kg)	2.35 lb. (1.07 kg)	2.35 lb. (1.07 kg)

① The pre-travel listed may vary up to 5° additional for universal switches or up to 2° additional for standard switches due to free travel of lever arm at initial position.

② Linear travel of cam on 1.5 in. (38.1mm) lever arm.

③ Remove spring from the positioning plate.

④ Sequence 3, 7, and 8 devices are available but are not recommended where high speed cams or lever arm snap-back is present. The application should be checked and No. 12 sequences substituted where possible.

Note: For Type FT foundry switches, change the "T" at the beginning of the equivalent Type number above to "FT" (Example: FTUB1). See page 218.

Limit Switches

9007FT Severe Duty Foundry Switches

Universal Operating Sequences

Universal Catalog Numbers

Base Plate

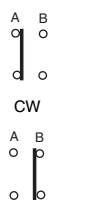
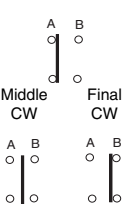
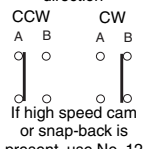
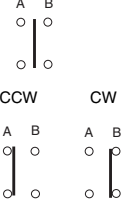
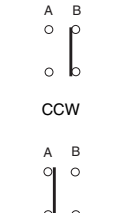
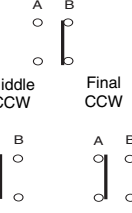





Surface Mounted	A	9007FTUA1	9007FTUA2	9007FTUA3	9007FTUA4	9007FTUA5	9007FTUA6
	B	9007FTUB1	9007FTUB2	9007FTUB3	9007FTUB4	9007FTUB5	9007FTUB6
C	9007FTUC1	9007FTUC2	9007FTUC3	9007FTUC4	9007FTUC5	9007FTUC6	9007FTUC6
D	9007FTUD1	9007FTUD2	9007FTUD3	9007FTUD4	9007FTUD5	9007FTUD6	9007FTUD6
	No. 1	No. 2	No. 3 ④	No. 4	No. 5	No. 6	
	SPDT Spring Return CW Only	SPDT Spring Return CW Only	SPDT Maintained Contact	SPDT Spring Return Neutral Position	SPDT Spring Return CCW Only	SPDT Spring Return CCW Only	
	Initial position and CCW 	Initial position and CCW 	Spring return of arm to initial pos. Contact pos. maintained until operated in reverse direction CCW CW 	Initial position 	Initial position and CW 	Initial position and CW 	

Characteristics

Nominal Operating Data

Pre-travel ①	14°	Int. Pos. 9°, Final 16°	7°	6°	14°	Int. Pos. 9°, Final 16°
Total travel	88°	88°	81°	81°	88°	88°
Differential	12°	5°	7°	5°	12°	5°
Operating torque	12 lb-in (1.35 N•m)	12 lb-in (1.35 N•m)	12 lb-in (1.35 N•m)	12 lb-in (1.35 N•m)	12 lb-in (1.35 N•m)	12 lb-in (1.35 N•m)
Repeat accuracy ②	± 0.004 in. (0.10 mm)	± 0.004 in. (0.10 mm)	± 0.004 in. (0.10 mm)	± 0.004 in. (0.10 mm)	± 0.004 in. (0.10 mm)	± 0.004 in. (0.10 mm)

To convert sequences, remove base plate, position plate and latches. Reassemble positioning plate and latches as shown.

						
Weight lb (kg)	2.57 lb (1.17 kg)	2.57 lb (1.17 kg)	2.57 lb (1.17 kg)	2.57 lb (1.17 kg)	2.57 lb (1.17 kg)	2.57 lb (1.17 kg)

Universal Catalog Numbers (continued)

Base Plate

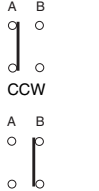
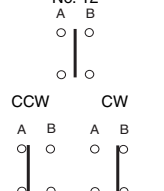
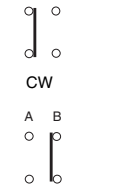
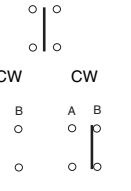
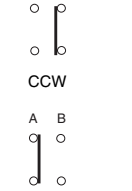
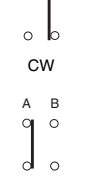



Surface Mounted	A	9007FTUA7	9007FTUA8	9007FTUA9	9007FTUA10	9007FTUA11	9007FTUA12
	B	9007FTUB7	9007FTUB8	9007FTUB9	9007FTUB10	9007FTUB11	9007FTUB12
C	9007FTUC7	9007FTUC8	9007FTUC9	9007FTUC10	9007FTUC11	9007FTUC12	9007FTUC12
D	9007FTUD7	9007FTUD8	9007FTUD9	9007FTUD10	9007FTUD11	9007FTUD12	9007FTUD12
	No. 7	No. 8 ④	No. 9	No. 10	No. 11	No. 12	
	SPDT Maintained	SPDT Maintained Neutral Position	SPDT Spring Return Slow Make, Slow Break	SPDT Spring Return Slow Make, Slow Break	SPDT Spring Return Slow Make, Slow Break	SPDT Maintained	
	If high speed cam or snap-back present, use No. 12 	Initial position If high speed cam or snap-back present, use No. 12 	Initial position and CCW 	Initial position 	Initial position and CW 	CCW 	

Characteristics

Nominal Operating Data

Pre-travel ①	10°	6°	12°	3°	12°	45°
Total travel	85°	81°	87°	81°	87°	90°
Differential	12°	10°	0°	0°	0°	0°
Operating torque	2.5 lb-in (0.28 N•m)	2.5 lb-in (0.28 N•m)	12 lb-in (1.35 N•m)	12 lb-in (1.35 N•m)	12 lb-in (1.35 N•m)	8 lb-in (0.9 N•m)
Repeat accuracy ②	± 0.004 in. (0.10 mm)	± 0.004 in. (0.10 mm)	± 0.004 in. (0.10 mm)	± 0.004 in. (0.10 mm)	± 0.004 in. (0.10 mm)	± 0.004 in. (0.10 mm)

To convert sequences, remove base plate, position plate and latches. Reassemble positioning plate and latches as shown.

						Not adjustable
Weight lb (kg)	2.57 lb (1.17 kg)	2.57 lb (1.17 kg)	2.57 lb (1.17 kg)	2.57 lb (1.17 kg)	2.57 lb (1.17 kg)	2.57 lb (1.17 kg)

Footnotes: see page 219

Dimensions:
pages 222 to 225

Interpretation of Catalog Numbers:
page 239

Limit Switches

9007FT Severe Duty Foundry Switches

Standard Operating Sequences

Standard Catalog Numbers

Base Plate

Surface
Mounted

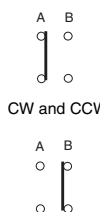
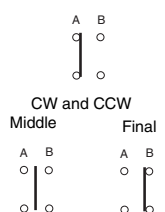
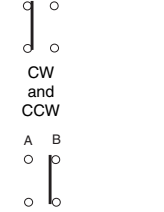

A	9007FTSA1	9007FTSA2	9007FTSA3		
B	9007FTSB1	9007FTSB2	9007FTSB3		
C	9007FTSC1	9007FTSC2	9007FTSC3		
D	9007FTSD1	9007FTSD2	9007FTSD3		
No. 1		No. 2		No. 3	
Single Pole Double Throw Spring Return CW & CCW		Single Pole Double Throw Spring Return CW & CCW		Single Pole Double Throw Spring Return CW & CCW Slow Make Slow Break	
Initial position 		Initial position 		Initial position 	

Characteristics (nominal operating data)

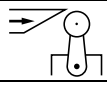
Switch actuation	By 30° cam		
Type of actuation			
Pre-travel ①	14°	Int. Pos. 9°, Final 16°	9°
Total travel	89°	89°	89°
Differential	12°	Int. Pos. 5.5°, Final 7.5°	5°
Reverse overtravel	N/A (future availability)	N/A (future availability)	N/A (future availability)
Operating torque/force 1 pole & 2 pole	10 lb-in (1.13 N•m)	10 lb-in (1.13 N•m)	10 lb-in (1.13 N•m)
Terminal wire sizes (Cabling/Screw Clamp)	#12–22 AWG (3.31–0.326 mm ²)	#12–22 AWG (3.31–0.326 mm ²)	#12–22 AWG (3.31–0.326 mm ²)
Repeatability ② (linear travel of cam)	± 0.004 in. (0.10 mm)	± 0.004 in. (0.10 mm)	± 0.004 in. (0.10 mm)
Cable entry (metric available)	1/2" NPT	1/2" NPT	1/2" NPT
Weight lb (kg)	2.57 lb. (1.17 kg)	2.57 lb. (1.17 kg)	2.57 lb. (1.17 kg)

① The pre-travel listed may vary up to 5° additional for universal switches or up to 2° additional for standard switches due to free travel of lever arm at initial position.

② Linear travel of cam on 1.5 in. (38.1mm) lever arm.

③ Remove spring from the positioning plate.

④ Sequence 3, 7, and 8 devices are available but are not recommended where high speed cams or lever arm snap-back is present. The application should be checked and No. 12 sequences substituted where possible.

Note: Type FT Foundry Switches are obtained by changing the "T" at the beginning of the equivalent type number to "FT" (Example: FTUB1).

Limit Switches

9007T and FT Severe Duty Mill and Foundry Switches

Lever Arms and Renewal Parts



Standard Roller

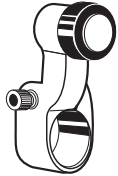

Offset Type

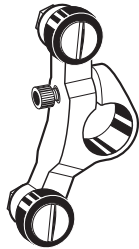

120° Forked

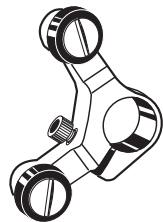

90° Forked

Standard Roller

Arm		Steel Roller		Catalog Number	Weight lb (kg)
Length in. (mm)	Diameter in. (mm)	Roller Position	Width in. (mm)		
1.5 (38.1)	0.75 (19)	Optional	0.25 (6.3)	9007B1	0.17 (0.077)
1.5 (38.1)	1.0 (25.4)	Optional	0.25 (6.3)	9007B2	0.19 (0.086)
1.5 (38.1)	1.38 (35)	Optional	0.25 (6.3)	9007B3	0.23 (0.104)
2.5 (63.5)	0.75 (19)	Optional	0.25 (6.3)	9007B7	0.25 (0.113)
2.5 (63.5)	1.0 (25.4)	Optional	0.25 (6.3)	9007B8	0.25 (0.113)
2.5 (63.5)	1.38 (35)	Optional	0.25 (6.3)	9007B9	0.27 (0.122)
1.5 (38.1)	0.75 (19)	Optional	0.5 (12.7)	9007B12	0.34 (0.154)
1.5 (38.1)	1.0 (25.4)	Optional	0.5 (12.7)	9007B13	0.34 (0.154)
1.5 (38.1)	1.38 (35)	Optional	0.5 (12.7)	9007B14	0.42 (0.191)
5 (127)	0.75 (19)	Optional	0.25 (6.3)	9007B19	1.00 (0.454)
2.88 (73.1)	0.75 (19)	No roller	—	9007B21	0.20 (0.091)
2.5 (63.5)	0.75 (19)	Optional	0.5 (12.7)	9007B22	0.22 (0.100)
2.5 (63.5)	1.0 (25.4)	Optional	0.5 (12.7)	9007B23	0.28 (0.127)
2.5 (63.5)	1.38 (35)	Optional	0.5 (12.7)	9007B24	0.36 (0.163)
Adjustable ⁽¹⁾	0.75 (19)	Optional	0.25 (6.3)	9007R18	0.50 (0.227)
Adjustable ⁽¹⁾	1.0 (25.4)	Optional	0.25 (6.3)	9007R19	0.50 (0.227)
Adjustable ⁽¹⁾	1.38 (35)	Optional	0.25 (6.3)	9007R20	0.50 (0.227)

1. Does not include lever arm clamp or rod. If lever arm clamp is required, use 9007R16 or R17.

Offset Type (for obtaining different cam track dimensions)

Arm		Steel Roller		Catalog Number	Weight lb (kg)
Length in. (mm)	Diameter in. (mm)	Roller Position	Width in. (mm)		
1.5 (38.1)	0.75 (19)	Inside offset	0.25 (6.3)	9007C1	0.50 (0.227)
1.5 (38.1)	1.0 (25.4)	Inside offset	0.25 (6.3)	9007C2	0.50 (0.227)
1.5 (38.1)	1.38 (35)	Inside offset	0.25 (6.3)	9007C3	0.50 (0.227)
1.5 (38.1)	0.75 (19)	Outside offset	0.25 (6.3)	9007D1	0.18 (0.082)
1.5 (38.1)	1.0 (25.4)	Outside offset	0.25 (6.3)	9007D2	0.18 (0.082)
1.5 (38.1)	1.38 (35)	Outside offset	0.25 (6.3)	9007D3	0.18 (0.082)
1.88 (48)	0.75 (19)	Outside offset	0.25 (6.3)	9007E4	0.20 (0.091)
1.88 (48)	1.0 (25.4)	Outside offset	0.25 (6.3)	9007E5	0.27 (0.122)
1.88 (48)	1.38 (35)	Outside offset	0.25 (6.3)	9007E6	0.27 (0.122)
1.88 (48)	0.75 (19)	Inside offset	0.25 (6.3)	9007F4	0.30 (0.136)
1.88 (48)	1.0 (25.4)	Inside offset	0.25 (6.3)	9007F5	0.30 (0.136)
1.88 (48)	1.38 (35)	Inside offset	0.25 (6.3)	9007F6	0.30 (0.136)

120° Forked (for maintained contact lever arm type switches)

Arm		Steel Roller		Catalog Number	Weight lb (kg)
Length in. (mm)	Diameter in. (mm)	Roller Position	Width in. (mm)		
1.5 (38.1)	0.75 (19)	Same side	0.25 (6.3)	9007J1	0.31 (0.141)
1.5 (38.1)	1.0 (25.4)	Same side	0.25 (6.3)	9007J2	0.40 (0.181)
1.5 (38.1)	0.75 (19)	LH on opp. side	0.25 (6.3)	9007K1	0.50 (0.227)
1.5 (38.1)	1.0 (25.4)	LH on opp. side	0.25 (6.3)	9007K2	0.50 (0.227)
1.5 (38.1)	0.75 (19)	RH on opp. side	0.25 (6.3)	9007N1	0.66 (0.299)
1.5 (38.1)	1.0 (25.4)	RH on opp. side	0.25 (6.3)	9007N2	0.70 (0.316)

90° Forked (for maintained contact lever arm type switches)

Arm		Steel Roller		Catalog Number	Weight lb (kg)
Length in. (mm)	Diameter in. (mm)	Roller Position	Width in. (mm)		
1.5 (38.1)	0.75 (19)	Same side	0.25 (6.3)	9007X1	0.30 (0.136)
1.5 (38.1)	1.0 (25.4)	Same side	0.25 (6.3)	9007X2	0.40 (0.181)
1.5 (38.1)	0.75 (19)	RH on opp. side	0.25 (6.3)	9007Y1	0.50 (0.227)
1.5 (38.1)	1.0 (25.4)	RH on opp. side	0.25 (6.3)	9007Y2	0.50 (0.227)
1.5 (38.1)	0.75 (19)	LH on opp. side	0.25 (6.3)	9007Z1	0.66 (0.299)
1.5 (38.1)	1.0 (25.4)	LH on opp. side	0.25 (6.3)	9007Z2	0.70 (0.316)

Dimensions:
pages 222 to 225

Limit Switches

9007T and FT Severe Duty Mill and Foundry Switches

Lever Arms and Renewal Parts

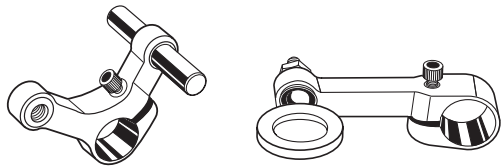

With Reset

Cable Operated



Rod Type
(rod not included)

Ball Bearing Type



Weld-On Type

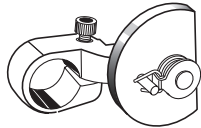

1-Way Roller Type

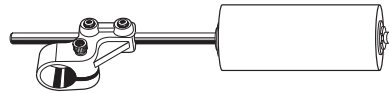

Conveyor Side Guide
(use with 9007R16 or R17)

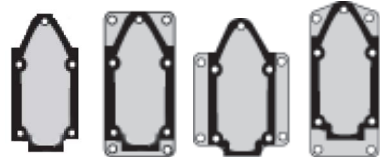

Style A Style B Style C Style D

Base Plates

Cable operated					
Arm	Steel roller	Roller		Catalog Number	Weight lb (kg)
Length in. (mm)	Diameter in. (mm)	Roller Position	Width in. (mm)		
1.5 (38.1)	0.75 (19)	None	None	9007Y3	—
2.5 in. (63.5mm) long with eyebolt 0.25 (6.3mm) I.D. instead of roller.				9007B27	—
Rod Type (used on conveyor systems or where unusual shapes are required)					
Adjustable	0.75 (19)	0.19 (4.8)	None	9007R16	0.18 (0.081)
Adjustable	0.75 (19)	0.25 (6.3)	None	9007R17	0.18 (0.081)
1. Rod not included 2. Key stock not included					
Ball Bearing Type (for abrasive dust areas or with high speed cams)					
1.5 (38.1)	0.75 (19)	Center	0.28 (7.1)	9007B16	0.15 (0.068)
Weld-On Type (used where a special operator is required to weld to lever)					
3.5 (89)	0.75 (19)	None	None	9007G10	0.50 (0.227)
One Way Roller Type (used with reversible cams for one way operations)					
1.5 (38.1)	0.75 (19)	Outside offset	0.25 (6.3)	9007D4	0.64 (0.290)
Conveyor Side Guide					
8.44 in. (214.3) long with 1.5 in. (38.1) dia. 3.75 in. (95.2) Delrin® roller				9007R21	1.63 (0.739)
8.44 in. (214.3) long with 0.88 in. (22.3) dia. 3.75 in. (95.2) Delrin roller				9007R22	1.42 (0.644)

Separate Base Plates (2)			
Style	Mounting Holes	Catalog Number	Weight lb (kg)
A	None (1)	2934D32G1	
B	End	2934D14G1	0.34 (0.154)
C	Side	2934D33G1	0.42 (0.191)
D	End	2934D34G1	0.36 (0.163)

- No mounting holes in base plate. Side mounting holes in switch case must be used.
- Acceptable wire sizes 14 – 18 AWG (2.08 – 0.823 mm²); recommended terminal clamp torque 13 – 16 lb-in. (1.46 – 1.80 N•m).

Optional Conduit Threads		
Description	Catalog Number	Weight lb (kg)
Metric		
M20 - 20mm (per B.S. 4568)	M11	—
Example: 9007TUB4M11		

Three Point Contacts — Ordering Information		
Select Type number of desired contact operating sequence for standard contact switch.		
Change the letter following "T" or "FT" as shown below.		
Change: For example: TUB1 changes to TYB1 TSB1 changes to TKB1	U to Y S to K	Contact Configuration Changes From: 

Limit Switches

9007T and FT Severe Duty Mill and Foundry Switches

Dimensions

Surface Mounting

Type T

Type FT

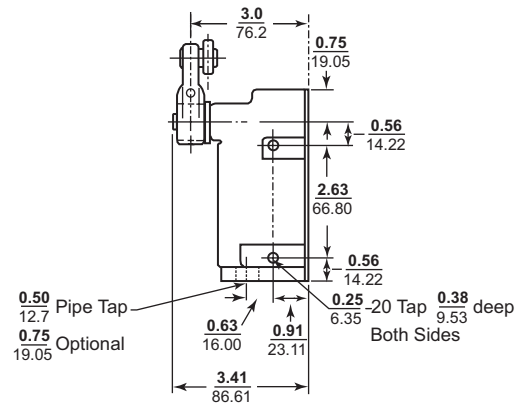
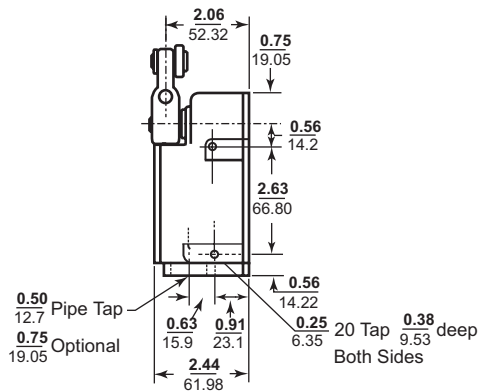

Base Plates

Style A

Style B

Style C

Style D

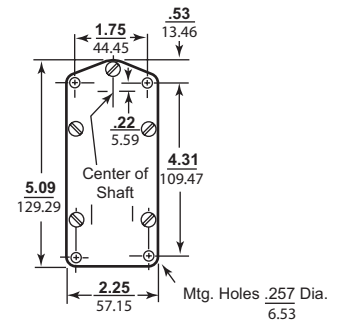
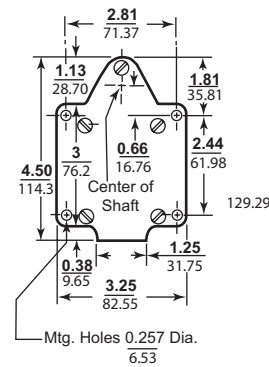
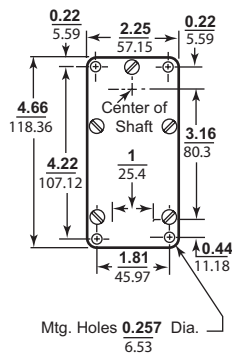
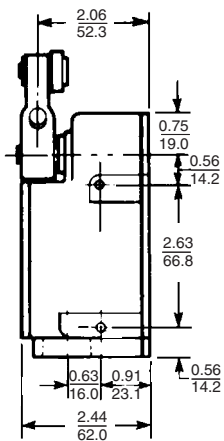

Dual dimensions: $\frac{\text{in.}}{\text{mm}}$

Limit Switches

Limit Switches

9007T and FT Severe Duty Mill and Foundry Switches

Dimensions

CAM Track Dimensions

Type T

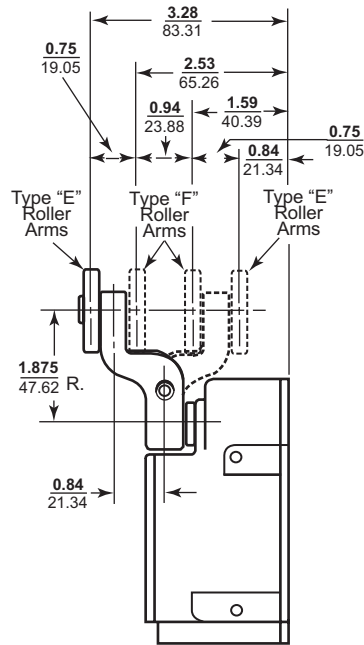
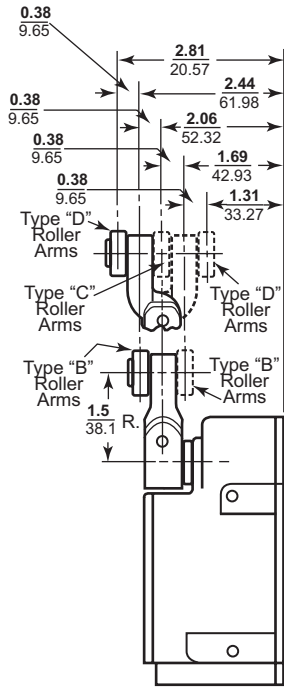

Type FT

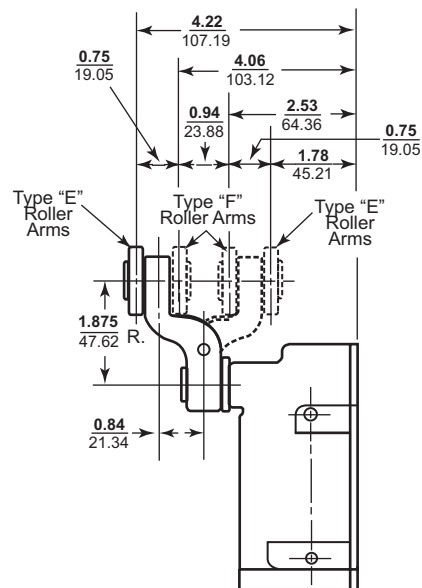
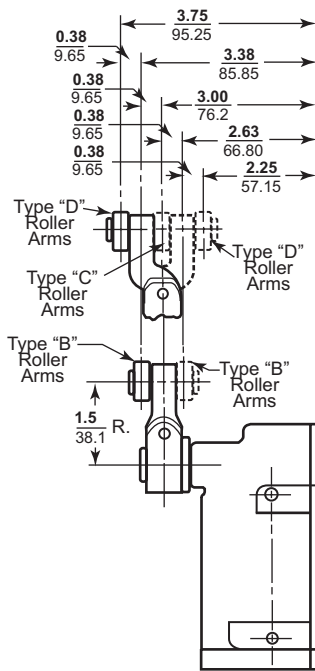

Dual dimensions: $\frac{\text{in.}}{\text{mm}}$

Limit Switches

9007T and FT Severe Duty Mill and Foundry Switches

Dimensions

Type T and FT Lever Arms

Standard Roller

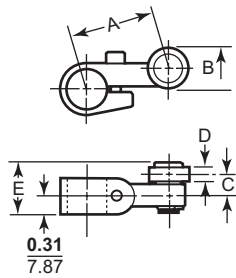

For dimension A refer to page 12.

Offset Type

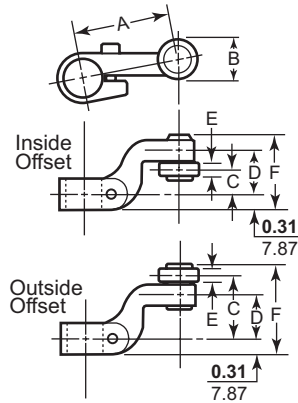

Adjustable Length Rod Type

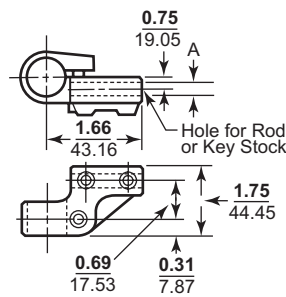

Ball Bearing Roller Type B16

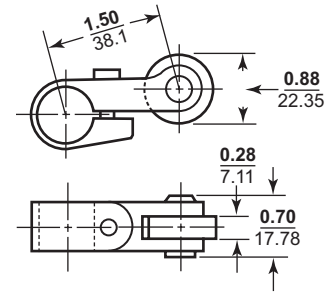

Roller Arm for use with Type R17

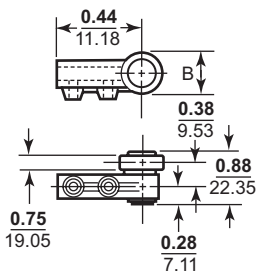

1-Way Roller Type D4

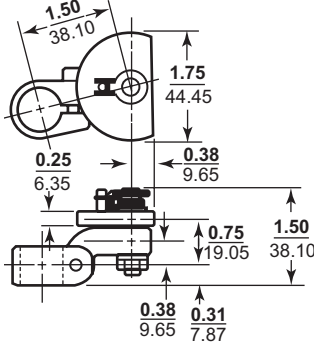

Weld-On Arm Type G10

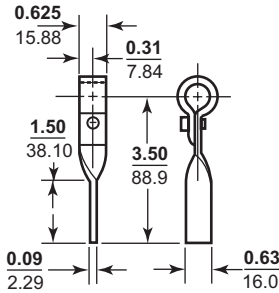

Cable Operated with Reset Type Y3

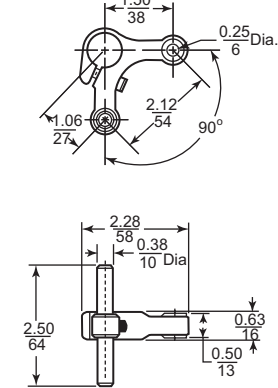

Cable Operated Type B27

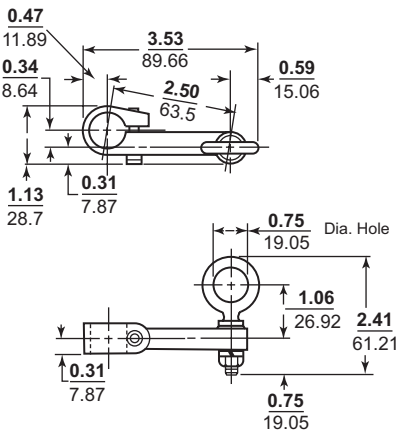

Limit Switches

NOTE: All levers on this page can be used on Type C limit switches by installing the 9007S9 hub.

Dual dimensions: $\frac{\text{in.}}{\text{mm}}$

Limit Switches

9007T and FT Severe Duty Mill and Foundry Switches

Dimensions

Type T and FT Lever Arms (continued)

90° Forked

120° Forked

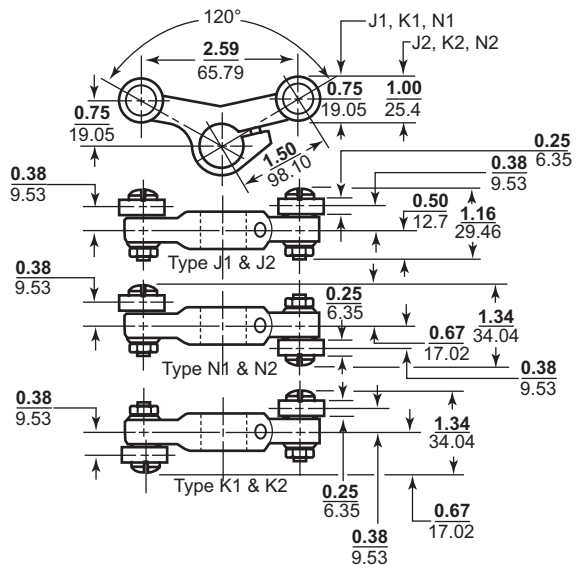
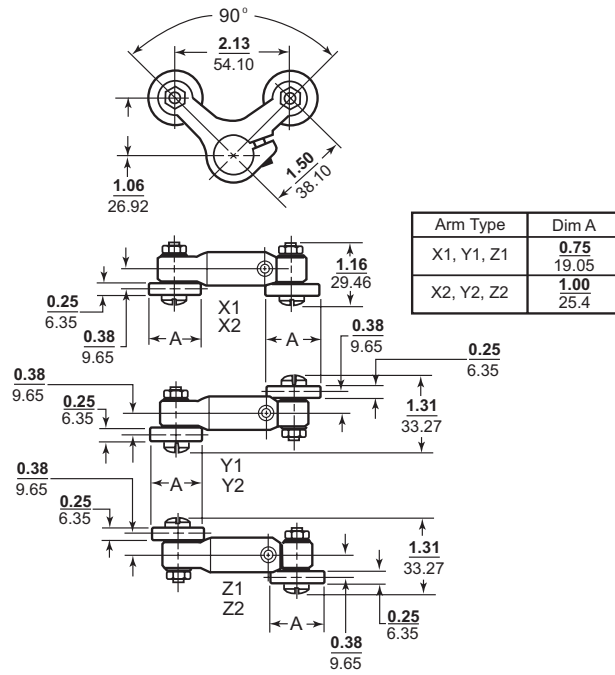

Limit Switches

R.B. Denison® Lox-Switch™ L Severe Duty Mill and Foundry Switches

L100, L300 Mill and Foundry Switches, L140, L2153 Cable Pulls, L529 Belt Conveyor

Conforming to NEMA A600 and UL508

Description

L100W Switches ♦

Use the L100W Mill switches instead of other limit switches in the following applications:

- Where the current load exceeds the typical heavy duty limit switch contact rating of 10 A and falls within the range of up to 20 A continuous.
- Where an operating sequence is required that is not possible on other limit switches (35 choices with the L switches).
- Where higher reset forces are required due to foreign material interfering with lever arm operation, or where long heavy arms must reset against gravity.

♦ L switches are not preceded by 9007. They are known as the R.B. Denison® Lox Switch™ L, and include conveyor belt and slack cable pull switches in the product offering.

L300W Switches

The L300W Foundry switches are for use in foundries or mills where the applications described above are required, and where falling foundry sand or similar material could build up and jam the operating mechanism. The shaft has a dust boot and extends from the switch case, preventing sand build up around the shaft. The devices can withstand hot falling sand up to 300° F (149° C).

Features L100, L300, L140, L2153, L525

- Captive cover screws
- Heavy duty snap action mechanism prevents teasing or false contact opening.
- Positive trip action prevents the lever from slipping around the 0.5 in. (12.7 mm) shaft even if not properly tightened.
- High current capability. 20 A maximum continuous
- Isolated (no polarity) double and triple circuits with double break (throw) action
- Wide 0.25 in. (6.3 mm) contact gap ensures very high shock and vibration resistance.
- Easy to access contacts allow for easy inspection and replacement.
- Stamped contact configuration number for easy identification even if the switch is painted
- Many contact arrangements to solve difficult applications
- Model L300 is an extra heavy duty version for very aggressive environments.
 - The booted shaft design prevents penetration of foreign materials such as sand, dust, or grit between the shaft and the bushing.
 - Heavy duty stainless steel springs and hardened spring operators permit longer life under extreme lever fly-back and high impact.
 - Same parameters as L100 models, except that the distance between the back of the switch and the lever is increased by 0.34 in. (8.6 mm).
- Two and three circuits in CW, CCW, neutral position, spring return and maintained, snap action or slow-make slow-break, two steps (L525) are available.
- 2 circuit models can be CW or CCW field converted.
- Wide range of options: high shock and vibration, with gold contact, low or very high temperature
- 0.5 in. (12.7 mm) NPT conduit entrance standard on 2-pole models (5 wires max.)
- 0.75 in. (19 mm) NPT conduit entrance standard on 3-pole models (7 wires max.)

L100, L300 Switches (fixed sequence)

L100 Mill

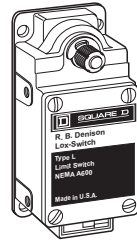

Page 228

L300 Foundry

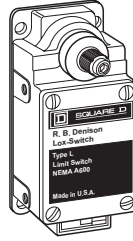

Page 230

- Model L300 is an extra heavy duty version for very aggressive environments
 - The booted shaft design prevents penetration of foreign materials such as sand, dust, or grit between the shaft and the bushing.
 - Heavy duty stainless steel springs and hardened spring operators permit longer life under extreme lever fly-back and high impact.
 - Same parameters as L100 models, except that the distance between the back of the switch and the lever is increased by 0.34 in. (8.6 mm).

Cable Pulls (fixed sequence)

L140 Mill and Foundry

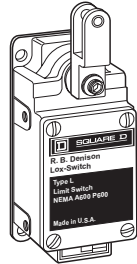

Page 232

L2153 Mill and Foundry

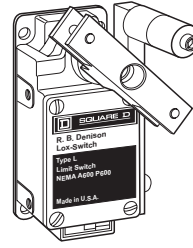

Page 232

Belt Conveyors

L525 Mill and Foundry

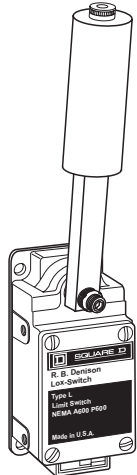

Page 233

Conveyor belt limit switches are ideal for policing the lateral movement of belt conveyors. When the conveyor belt shifts, it contacts the switch roller and a 12° movement of the lever transfers the first set of contacts. This set is usually wired to initiate a warning alarm system to alert the worker that the belt is moving off the rollers. Further lateral movement of the belt, causing the lever to move another 8°, trips the second set of contacts. These contacts are normally wired to the conveyor drive system and when actuated stop the system, minimizing damage to the conveyor or loss of material on the belt.

Limit Switches

R.B.Denison® Lox-Switch™ L Severe Duty Mill and Foundry Switches

L100, L300 Mill and Foundry Switches, L140, L2153 Cable Pulls, L529 Belt Conveyor

Environmental characteristics	
Conforming to standards	UL508
Product certifications	UL Listed, CSA Certified, CE Marked
Protective treatment	Corrosion resistant gray paint
Ambient air temperature	-10 to +185 °F (-23 to +85 °C) With H prefix: -10 to +350 °F (-23 to +177 °C). (1)
Vibration resistance	10G (10–55 Hz)
Shock resistance	30G
Electric shock protection	Class O
Degree of protection	NEMA Types 1, 2, 4, 12, 13, IP65, 66, 67
Cable entry or connector	1/2" NPT (metric available)
Materials	Cast zinc ⬢

1. For a switch with an ambient temperature rating up to 350 °F (177 °C), add an H to the beginning of the catalog number.
For example, change catalog number L100WS2M2 to HL100WS2M2.

Contact block characteristics		
Rated operational characteristics hard contacts	AC Voltage	NEMA A600 Ithe = 20 A 20 A Resistive and continuous
Rated operational characteristics hard contacts	DC Voltage	NEMA P600 Ithe = 20 A 20 A Resistive and continuous
Rated insulation voltage		600 V
Rated impulse withstand voltage		2,500 Vac for 1 minute for CE, 2,200 Vac for 1 minute for UL, and 2,640 Vac for 1 minute for CSA
Positive opening		No
Short circuit protection		20 A Bussmann Class CC KTK-R-20 fuse, non-time-delay
Terminal wire sizes (Cabling/Screw Clamp)		12 – 22 AWG (3.31 mm ² – 0.326 mm ²) wire max.
Maximum actuation speed		15.2 mpm / 27.4 mpm (50 fpm / 90 fpm) with 45° Cam angle, levers only

Contacts	AC							DC				
	Volts	Inductive 35% Power Factor				Con- tinuous Carrying Amperes	Resistive 75% Power Factor		Volts	Inductive and Resistive		
		Make		Break			Make, Break and Continuous Carrying Amperes			Make and Break Amperes		Con- tinuous Carrying Amperes
		Amperes	VA	Amperes	VA				Single Throw	Double Throw		
SPDT Quick Make and Break	120	150	18,000	20	2400	20	20	120	5.0	Ⓟ	20	
	240	75	18,000	12.5	3000	20	20	250	1.0	Ⓟ	20	
	480	37.5	18,000	6.25	3000	20	20	600	0.2	Ⓟ	20	
	600	30	18,000	5	3000	20	20					
All Slow Make and Break	120	60	7200	6	720	20	10	20	Ⓟ	Ⓟ	Ⓟ	
	240	30	7200	3	720	20	10	20	Ⓟ	Ⓟ	Ⓟ	
	480	15	7200	1.5	720	20	10	20	Ⓟ	Ⓟ	Ⓟ	
	600	12	7200	1.2	720	20	10	20	Ⓟ	Ⓟ	Ⓟ	

Characteristics for material and ratings comparisons — standard switches ⬢		
	9007 Type T/FT	Type L (R. B. Denison Lox Switch)
Body material	Cast zinc	Cast aluminum
Cover material	Cast zinc	Aluminum
Base plate material	Steel with zinc plating	Steel with chromate plating
Shaft seal material	Nitrile	PVC
Contact block material	Phenolic	Glass filled nylon
Moveable contact material	Fine silver on copper backing	Coin Silver on steel backing
Stationary contact material	Fine silver on copper backing	90/10 AgCdO on copper backing
Low ambient temperature rating	-10° F	0° F
High ambient temperature at full rating ⬢	180° F	200° F
Enclosure rating	NEMA Types 1, 2, 4, 12 and 13	NEMA Types 1, 4 and 13
Vibration resistance	10G (10–150 Hz)	40G max (10-150 Hz)

⬢ Many switches are available with higher or lower temperature limits by selecting special versions or special options. See page 237.

Limit Switches

R.B.Denison® Lox-Switch™ L Severe Duty Mill and Foundry Switches

L100 Mill Switches

L100 Mill Switches					
Description	Operating Torque	Contact Diagram	Catalog Number	Operating Data	Weight, lb (kg)
Snap-action CW spring return	190 oz-in (1.34 N•m)		L100WS2M1	A (see page 229)	1.51 (0.68)
Snap-action CCW spring return	190 oz-in (1.34 N•m)		L100WS2M2	A (see page 229)	1.51 (0.68)
Maintained contact ■ CW and CCW snap action	45 oz-in (0.32 N•m)		L100WS2M3	A (see page 229)	1.51 (0.68)
Snap action CW spring return	190 oz-in (1.34 N•m)		L100WDR2M4	A (see page 229)	1.51 (0.68)
Snap action CCW spring return	190 oz-in (1.34 N•m)		L100WDR2M5	A (see page 229)	1.51 (0.68)
Maintained contact ■ CW and CCW snap action	45 oz-in (0.32 N•m)		L100WDR2M6	A (see page 229)	1.51 (0.68)
Snap action CCW spring return	190 oz-in (1.34 N•m)		L100WDL2M7	A (see page 229)	1.51 (0.68)
Snap action CW spring return	190 oz-in (1.34 N•m)		L100WDL2M8	A (see page 229)	1.51 (0.68)
Snap action CW 1 N.C./ 2 N.O. spring return	190 oz-in (1.34 N•m)		L100WTR2M10	A (see page 229)	1.51 (0.68)
Snap action CCW 1 N.O./ 2 N.C. spring return	190 oz-in (1.34 N•m)		L100WTR2M11	A (see page 229)	1.51 (0.68)
Maintained contact ■ CW and CCW snap action 3 poles	45 oz-in (0.32 N•m)		L100WTR2M12	A (see page 229)	1.51 (0.68)
Snap action CCW 2 N.O./ 1 N.C. spring return	190 oz-in (1.34 N•m)		L100WTL2M13	A (see page 229)	1.51 (0.68)
Snap action CW 1 N.O./ 2 N.C. spring return	190 oz-in (1.34 N•m)		L100WTL2M14	A (see page 229)	1.51 (0.68)
Maintained contact ■ CW and CCW snap action 3 poles	45 oz-in (0.32 N•m)		L100WTL2M15	A (see page 229)	1.51 (0.68)
Neutral position ■ spring return slow make and break 1 N.O. contact per direction	95 oz-in (0.67 N•m)		L100WN2M16	B (see page 229)	1.51 (0.68)
Neutral position ■ spring return slow make and break 1 N.O. contact for both directions	95 oz-in (0.67 N•m)		L100WN2M17	B (see page 229)	1.51 (0.68)

Dimensions:
page 238

Operating Data:
page 229

Interpretation of Catalog Numbers:
page 239

Limit Switches

R.B.Denison® Lox-Switch™ L Severe Duty Mill and Foundry Switches

L100 Mill Switches

L100 Mill Switches (continued)					
Description	Operating Torque	Contact Diagram	Catalog Number	Operating Data	Weight, lb (kg)
Neutral position ■ spring return slow make and break 1 N.C.-CW, 1 N.O.-CCW	95 oz-in (0.67 N•m)		L100WNC2M18	B (see table below)	1.51 (0.68)
Neutral position ■ spring return slow make and break 2 N.O.-CW, 1 N.O.-CCW	95 oz-in (0.67 N•m)		L100WTRN2M20	B (see table below)	1.51 (0.68)
Neutral position ■ spring return slow make and break N.O.-CW, 2 N.O.-CCW	95 oz-in (0.67 N•m)		L100WTLN2M21	B (see table below)	1.51 (0.68)
Slow make-before-break CW spring return	170 oz-in (1.2 N•m)		L100WS02M22	C (see table below)	1.51 (0.68)
Slow make-before-break CCW spring return	170 oz-in (1.2 N•m)		L100WS02M23	C (see table below)	1.51 (0.68)
Neutral position ■ N.O.-CW, N.O.-CCW spring return snap action	170 oz-in (1.2 N•m)		L100WNS2M26	D (see table below)	1.51 (0.68)
Neutral position ■ N.O.-CW, N.O.-CCW maintained in CCW only	170 oz-in (1.2 N•m)		L100WNSR2M28	D (see table below)	1.51 (0.68)
Neutral position ■ N.O.-CW, N.O.-CCW maintained in CW only	170 oz-in (1.2 N•m)		L100WNSL2M29	D (see table below)	1.51 (0.68)
Neutral position ■ N.C.-CW, N.C.-CCW spring return snap action	170 oz-in (1.2 N•m)		L100WNC2M34	D (see table below)	1.51 (0.68)
Neutral position ■ N.O.-CW, N.O./N.C.-CCW spring return slow make and break	95 oz-in (0.67 N•m)		L100WTRN1C2M38	B (see table below)	1.51 (0.68)
Neutral position ■ N.O./N.C.-CW, N.O.-CCW spring return slow make and break	95 oz-in (0.67 N•m)		L100WTLN1C2M39	B (see table below)	1.51 (0.68)
Neutral position ■ N.O./N.C.-CW, N.C.-CCW spring return slow make and break	95 oz-in (0.67 N•m)		L100WTRN2C2M40	B (see table below)	1.51 (0.68)
Neutral position ■ N.C.-CW, N.O./N.C.-CCW spring return slow make and break	95 oz-in (0.67 N•m)		L100WTLN2M41	B (see table below)	1.51 (0.68)
Neutral position ■ N.O./N.C.-CW, N.C.-CCW spring return snap action	95 oz-in (0.67 N•m)		L100WTRN2CS2M48	D (see table below)	1.51 (0.68)

Operating Data for Contact Arrangements				
	A	B	C	D
Pretravel	17° nominal	7° maximum	7° nominal	9° nominal
Differential travel	11° nominal	4° maximum	—	6° nominal
Overlapping travel	—	—	4° nominal	—
Total travel	80°	70°	80°	70°
Recommended installation travel	20°–35°	10° – 25°	20° – 35°	13° – 30°
Repetitive accuracy of switch	± 0.03x	—	—	± 0.03x
Operating torque, max with return spring	190 oz-in (1.34 N•m)	95 oz-in (0.67 N•m)	170 oz-in (1.2 N•m)	170 oz-in (1.2 N•m)
Maintained contact	45 oz-in (0.317 N•m)	—	—	45 oz-in (0.317 N•m)

Dimensions:
page 238

Operating Sequences for Conveyor Belts:
page 233

Limit Switches

R.B.Denison® Lox-Switch™ L Severe Duty Mill and Foundry Switches

L300 Foundry Switches

L300 Foundry Switches					
Description	Operating Torque	Contact Diagram	Catalog Number	Operating Data	Weight, lb (kg)
Snap-action CW spring return	190 oz-in (1.34 N•m)		L300WS2M1	A (see page 231)	1.54 (0.70)
Snap-action CCW spring return	190 oz-in (1.34 N•m)		L300WS2M2	A (see page 231)	1.54 (0.70)
Maintained contact ■ CW and CCW snap action	45 oz-in (0.32 N•m)		L300WS2M3	A (see page 231)	1.54 (0.70)
Snap action CW spring return	190 oz-in (1.34 N•m)		L300WDR2M4	A (see page 231)	1.54 (0.70)
Snap action CCW spring action	190 oz-in (1.34 N•m)		L300WDR2M5	A (see page 231)	1.54 (0.70)
Maintained contact ■ CW and CCW snap action	45 oz-in (0.32 N•m)		L300WDR2M6	A (see page 231)	1.54 (0.70)
Snap action CCW spring return	190 oz-in (1.34 N•m)		L300WDL2M7	A (see page 231)	1.54 (0.70)
Snap action CW spring return	190 oz-in (1.34 N•m)		L300WDL2M8	A (see page 231)	1.54 (0.70)
Snap action CW 1 N.C./2 N.O. spring return	190 oz-in (1.34 N•m)		L300WTR2M10	A (see page 231)	1.54 (0.70)
Snap action CCW 1 N.O./2 N.C. spring return	190 oz-in (1.34 N•m)		L300WTR2M11	A (see page 231)	1.54 (0.70)
Maintained contact ■ CW and CCW snap action 3 poles	45 oz-in (0.32 N•m)		L300WTR2M12	A (see page 231)	1.54 (0.70)
Snap action CCW 2 N.O./1 N.C. spring return	190 oz-in (1.34 N•m)		L300WTL2M13	A (see page 231)	1.54 (0.70)
Snap action CW 1 N.O./2 N.C. spring return	190 oz-in (1.34 N•m)		L300WTL2M14	A (see page 231)	1.54 (0.70)
Maintained contact ■ CW and CCW snap action 3 poles	45 oz-in (0.32 N•m)		L300WTL2M15	A (see page 231)	1.54 (0.70)
Neutral position ■ spring return slow make and break 1 N.O. contact per direction	95 oz-in (0.67 N•m)		L300WN2M16	B (see page 231)	1.54 (0.70)
Neutral position ■ spring return slow make and break 1 N.O. contact for both directions	95 oz-in (0.67 N•m)		L300WN2M17	B (see page 231)	1.54 (0.70)

Dimensions:
page 238

Operating Data:
page 231

Interpretation of Catalog Numbers:
page 239

Limit Switches

R.B.Denison® Lox-Switch™ L Severe Duty Mill and Foundry Switches

L300 Foundry Switches

L300 Foundry Switches (continued)					
Description	Operating Torque	Contact Diagram	Catalog Number	Operating Data	Weight, lb (kg)
Neutral position ■ spring return slow make and break 1 N.C.-CW, 1 N.C.-CCW	95 oz-in (0.67 N•m)		L300WNC2M18	B (see table below)	1.54 (0.70)
Neutral position ■ spring return slow make and break 2 N.O.-CW, 1 N.O.-CCW	95 oz-in (0.67 N•m)		L300WTRN2M20	B (see table below)	1.54 (0.70)
Neutral position ■ spring return slow make and break N.O.-CW, 2 N.O.-CCW	95 oz-in (0.67 N•m)		L300WTLN2M21	B (see table below)	1.54 (0.70)
Slow make-before-break CW spring return	170 oz-in (1.2 N•m)		L300WS02M22	C (see table below)	1.54 (0.70)
Slow make-before-break CCW spring return	170 oz-in (1.2 N•m)		L300WS02M23	C (see table below)	1.54 (0.70)
Neutral position ■ N.O.-CW, N.O.-CCW spring return snap action	170 oz-in (1.2 N•m)		L300WNS2M26	D (see table below)	1.54 (0.70)
Neutral position ■ N.O.-CW, N.O.-CCW maintained in CCW only	170 oz-in (1.2 N•m)		L300WNSR2M28	D (see table below)	1.54 (0.70)
Neutral position ■ N.O.-CW, N.O.-CCW maintained in CW only	170 oz-in (1.2 N•m)		L300WNSL2M29	D (see table below)	1.54 (0.70)
Neutral position ■ N.C.-CW, N.C.-CCW spring return snap action	170 oz-in (1.2 N•m)		L300WNCS2M34	D (see table below)	1.54 (0.70)
Neutral position ■ N.O.-CW, N.O./N.C.-CCW spring return slow make and break	95 oz-in (0.67 N•m)		L300WTRN1C2M38	B (see table below)	1.54 (0.70)
Neutral position ■ N.O./N.C.-CW, N.O.-CCW Spring return slow make and break	95 oz-in (0.67 N•m)		L300WTLN1C2M39	B (see table below)	1.54 (0.70)
Neutral position ■ N.O./N.C.-CW, N.C.-CCW spring return slow make and break	95 oz-in (0.67 N•m)		L300WTRN2C2M40	B (see table below)	1.54 (0.70)
Neutral position ■ N.C.-CW, N.O./N.C.-CCW spring return slow make and break	95 oz-in (0.67 N•m)		L300WTLN2M41	B (see table below)	1.54 (0.70)
Neutral position ■ N.O./N.C.-CW, N.C.-CCW spring return snap action	95 oz-in (0.67 N•m)		L300WTRN2CS2M48	D (see table below)	1.54 (0.70)

Operating Data for Contact Arrangements	A	B	C	D
Pretravel	17° nominal	7° maximum	7° nominal	9° nominal
Differential travel	11° nominal	4° maximum	—	6° nominal
Overlapping travel	—	—	4° nominal	—
Total travel	80°	70°	80°	70°
Recommended installation travel	20°-35°	10° - 25°	20° - 35°	13° - 30°
Repetitive accuracy of switch	± 0.03x	—	—	± 0.03x
Operating torque, max with return spring	190 oz-in (1.34 N•m)	95 oz-in (0.67 N•m)	170 oz-in (1.2 N•m)	170 oz-in (1.2 N•m)
Maintained contact	45 oz-in (0.317 N•m)	—	—	45 oz-in (0.317 N•m)

Dimensions:
page 238

Operating Sequences for Conveyor Belts:
page 233

Limit Switches

R.B.Denison® Lox-Switch™ L Severe Duty Mill and Foundry Switches L140 and L2153 Cable Pulls



L140 Cable Pull



L2153 Dual Pull Stop

L140 Series Cable Pulls (1)

Circuit	Direction	Catalog Number (2)	Weight lb (kg)
1 N.C.	CW right	L142	1.54 (0.70)
1 N.O. and 1 N.C.	CW right	L143	1.54 (0.70)
1 N.O. and 1 N.C.	CCW left	L144	1.54 (0.70)
1 N.C.	CCW left	L145	1.54 (0.70)
2 N.O. and 1 N.C.	CW right	L146	1.54 (0.70)
2 N.C. and 1 N.O.	CW right	L147	1.54 (0.70)
2 N.O. and 1 N.C.	CCW left	L148	1.54 (0.70)
2 N.C. and 1 N.O.	CCW left	L149	1.54 (0.70)

1. Style K levers were designed specifically for this application; see page 235 (order separately).
2. To complete the catalog number, refer to page 239 and add the suffix for the mounting plate style and the front cover material.

L2153 Dual Pull Stop



Description	Catalog Number	Weight lb (kg)
Dual pull cord switch—maintained contacts (stop and lever included)	L2153	2.04 (0.93)

Characteristics

Pretravel	17° ± 2°
Differential travel	11° ± 2°
Overlapping travel	—
Total travel	80°
Recommended installation travel	—
Repetitive accuracy of switch	± 0.03x
Operating torque, max with return spring	13–27 lb-in (1.47–3.05 N•m)
Reset torque	7–19 lb-in (0.79–2.14 N•m)
Temperature range	-20 to 120 °F (-6.6 to 48.8 °C)
Maintained contact	—

Limit Switches

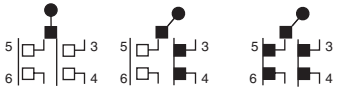
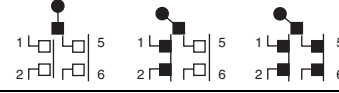
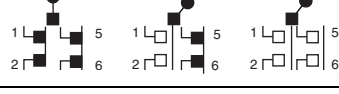
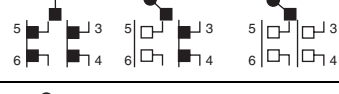
R.B.Denison® Lox-Switch™ L Severe Duty Mill and Foundry Switches L525 Belt Conveyor Switches

L525 Belt Conveyor Switches				
Description	Operating Torque	Contact Diagram	Catalog Number	Weight lb (kg)
2 step sequence CW spring return, snap action, 2 N.O.	150 oz-in (1.06 N•m)		L525WDR2M56	1.5 (0.68)
2 step sequence CCW spring return, snap action, 2 N.O.	150 oz-in (1.06 N•m)		L525WDL2M57	1.5 (0.68)
2 step sequence CW spring return, snap action, 2 N.C.	150 oz-in (1.06 N•m)		L525WDL2M58	1.5 (0.68)
2 Step sequence CCW spring return, snap action, 2 N.C	150 oz-in (1.06 N•m)		L525WDR2M59	1.5 (0.68)
2 Step sequence CW spring return, snap action, N.O./N.C	150 oz-in (1.06 N•m)		L100WS0S2M60	1.5 (0.68)

■ Two step snap action. One normally closed, one normally open; CW operation to first step to 2-C. Further CW operation to second step, 1-O, 1-C. Spring return. Pretravel 9° nominal. Additional travel 8° nominal. Differential second step 7° nominal. Differential first step 7° nominal.

Characteristics

Pretravel	12° nominal
Additional travel	8° nominal
Differential travel	7× nominal
Total travel	75° nominal
Operating torque, max with return spring	150 oz-in nominal (1.06 N•m)

Dimensions:
page 238

Limit Switches

R.B.Denison® Lox-Switch™ L Severe Duty Mill and Foundry Switches L100/L300 Lever Arms

Lever Arms

Lever arms are constructed of machined aluminum.

Dual dimensions: in. (mm)

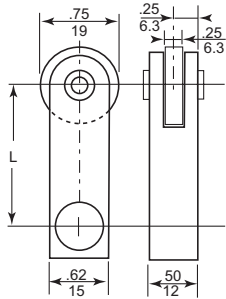

Style A

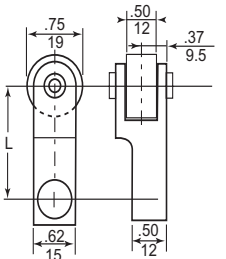

Style B

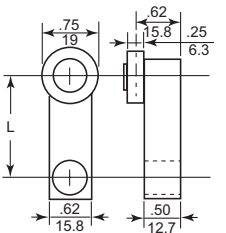

Style C

Style A Steel Roller				
Arm	Steel roller		Catalog Number ♦	Weight lb (kg)
Length	Diameter	Width		
1.25 (31.7)	0.75 (19)	0.25 (6.3)	AC	0.06 (0.027)
1.50 (38.1)	0.75 (19)	0.25 (6.3)	AA	0.06 (0.027)
1.75 (44.4)	0.75 (19)	0.25 (6.3)	AD	0.07 (0.031)
2.00 (50.8)	0.75 (19)	0.25 (6.3)	AH	0.08 (0.036)
2.25 (57.1)	0.75 (19)	0.25 (6.3)	AJ	0.09 (0.041)
2.50 (63.5)	0.75 (19)	0.25 (6.3)	AO	0.10 (0.045)
2.75 (69.8)	0.75 (19)	0.25 (6.3)	AK	0.10 (0.045)
3.00 (76.2)	0.75 (19)	0.25 (6.3)	AB	0.11 (0.050)
3.50 (88.9)	0.75 (19)	0.25 (6.3)	AL	0.12 (0.054)
4.00 (101.6)	0.75 (19)	0.25 (6.3)	AM	0.13 (0.059)
4.50 (114.3)	0.75 (19)	0.25 (6.3)	AN	0.14 (0.064)
5.00 (127.0)	0.75 (19)	0.25 (6.3)	AP	0.16 (0.073)
5.50 (139.7)	0.75 (19)	0.25 (6.3)	AQ	0.18 (0.082)
6.00 (152.4)	0.75 (19)	0.25 (6.3)	AR	0.20 (0.091)

♦ Example: AC — This is the complete catalog number to order.

Style A Options		
Diameter	Description	Catalog Number—Add Suffix
1.00 (25.4)	Roller	1
1.25 (32)	Roller	4
1.50 (38.1)	Roller	2
—	Nylon roller	N
0.75 (19)	Ball bearing roller	R
—	Stainless steel roller	NS

Style B Steel Roller				
Arm	Steel roller		Catalog Number	Weight lb (kg)
Length	Diameter	Width		
1.50 (38.1)	0.75 (19)	0.50 (12.7)	BA	0.06 (0.027)
2.00 (50.8)	0.75 (19)	0.50 (12.7)	BH	0.08 (0.036)
2.50 (63.5)	0.75 (19)	0.50 (12.7)	BO	0.10 (0.045)
3.00 (76.2)	0.75 (19)	0.50 (12.7)	BB	0.12 (0.054)
4.00 (101.6)	0.75 (19)	0.50 (12.7)	BM	0.13 (0.059)
4.50 (114.3)	0.75 (19)	0.50 (12.7)	BN	0.14 (0.064)
5.50 (139.7)	0.75 (19)	0.50 (12.7)	BQ	0.18 (0.082)
6.00 (152.4)	0.75 (19)	0.50 (12.7)	BR	0.20 (0.091)

Style B Options		
Diameter	Description	Catalog Number—Add Suffix
—	Nylon roller	N
1.50 (38.1)	Roller	2

Style C Steel Roller On Side				
Arm	Steel roller		Catalog Number	Weight lb (kg)
Length	Diameter	Width		
1.25 (31.7)	0.75 (19)	0.25 (6.3)	CC	0.06 (0.027)
1.50 (38.1)	0.75 (19)	0.25 (6.3)	CA	0.06 (0.027)
1.75 (44.4)	0.75 (19)	0.25 (6.3)	CD	0.07 (0.031)
2.00 (50.8)	0.75 (19)	0.25 (6.3)	CH	0.08 (0.036)
2.50 (63.5)	0.75 (19)	0.25 (6.3)	CO	0.10 (0.045)
3.00 (76.2)	0.75 (19)	0.25 (6.3)	CB	0.11 (0.050)
3.50 (88.9)	0.75 (19)	0.25 (6.3)	CL	0.12 (0.054)
4.00 (101.6)	0.75 (19)	0.25 (6.3)	CM	0.13 (0.059)
6.00 (152.4)	0.75 (19)	0.25 (6.3)	CR	0.20 (0.091)

Style C Options		
Diameter	Description	Catalog Number—Add Suffix
1.0 (24.5)	Roller	1
1.25 (32)	Roller	4
1.50 (38.1)	Roller	2
—	Nylon roller	N

Dimensions:
page 238

Limit Switches

R.B.Denison® Lox-Switch™ L Severe Duty Mill and Foundry Switches

L100/L300 Lever Arms

Dual dimensions: in. (mm)

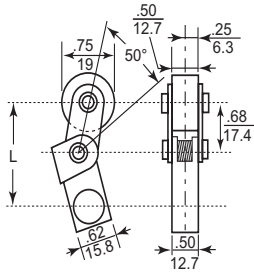

Style E

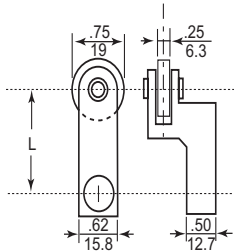

Style F

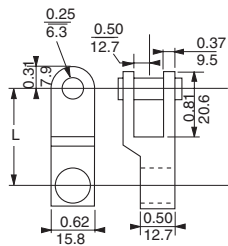

Style K

Style E One Way Steel Roller

Arm	Steel roller		Catalog Number	Weight lb (kg)
Length	Diameter	Width		
1.50 (38.1)	0.75 (19)	0.50 (12.7)	EA	0.30 (0.136)
1.75 (44.4)	0.75 (19)	0.50 (12.7)	ED	0.40 (0.181)
3.00 (76.2)	0.75 (19)	0.50 (12.7)	EB	0.50 (0.227)

Style E Options

Diameter in. (mm)	Description	Catalog Number Add Suffix
—	Nylon roller	N

Style F Offset Steel Roller

Arm	Steel roller	Roller Position		Catalog Number	Weight lb (kg)
Length	Diameter	Offset	Width		
1.50 (38.1)	0.75 (19)	0.62 (15.8)	0.15 (3.8)	FB	0.06 (0.027)
1.50 (38.1)	0.75 (19)	0.87 (22.2)	0.15 (3.8)	FA	0.06 (0.027)
1.50 (38.1)	0.75 (19)	1.00 (25.4)	0.15 (3.8)	FC	0.06 (0.027)
2.00 (50.8)	0.75 (19)	1.00 (25.4)	0.15 (3.8)	FE	0.08 (0.036)
2.50 (63.5)	0.75 (19)	1.00 (25.4)	0.15 (3.8)	FG	0.10 (0.045)
3.00 (76.2)	0.75 (19)	0.62 (15.8)	0.15 (3.8)	FI	0.11 (0.050)
3.00 (76.2)	0.75 (19)	1.00 (25.4)	0.15 (3.8)	FJ	0.11 (0.050)

Style F Options

Diameter	Description	Catalog Number—Add Suffix
1.00 (24.5)	Roller	1
—	Nylon roller	N

Style K (for use with L140 cable pulls)

Arm	Steel roller	Description	Catalog Number ♦	Weight lb (kg)
1.50 (38.1)	—	—	KA	0.05 (0.023)
2.50 (63.5)	—	—	KO	0.08 (0.036)
3.00 (76.2)	—	—	KB	0.09 (0.041)

♦ Example: KA — This is the complete catalog number to order.

Style L (renewal parts for L2153 dual pull stop)

Description	Catalog Number	Weight lb (kg)
Lever	AL1746	0.25 (0.113)
Mechanical stop	AL1649	0.10 (0.045)

Limit Switches

R.B.Denison® Lox-Switch™ L Severe Duty Mill and Foundry Switches

Lever Arms

Dual dimensions: in. (mm)

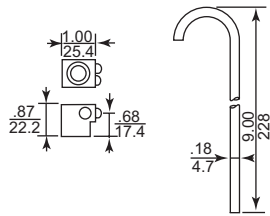

Style R

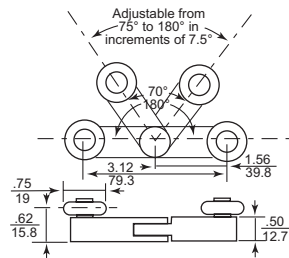

Style V

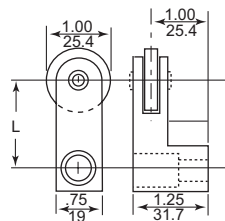

Style LA

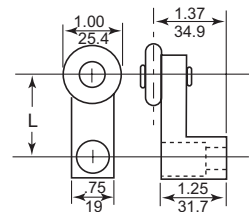

Style LC

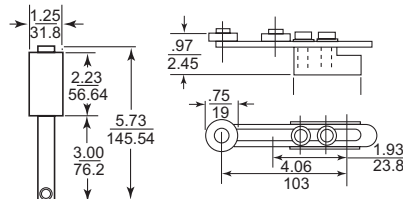

Rolling Pin

Adjustable Rolling Pin

Style R Steel Rod		
Description	Catalog Number	Weight lb (kg)
Hub only	R	0.10 (0.045)
Rod only	R9	0.09 (0.041)

Style V Yoke (for maintained position switches)		
Description	Catalog Number	Weight lb (kg)
Yoke	VA	0.50 (0.227)

Style V Options		
Diameter	Description	Catalog Number—Add Suffix
1.0 (24.5)	Roller	1
—	Nylon roller	N
0.75 (19)	Ball bearing roller	R

Style LA (to pass over switch cover)		
Arm	Catalog Number	Weight lb (kg)
Length		
1.50 (30)	LAA1	0.12 (0.054)
2.00 (50)	LAH1	0.12 (0.054)
2.50 (63)	LA01	0.12 (0.054)

Style LA Options		
Diameter	Description	Catalog Number—Add Suffix
1.5 (38)	Roller	2
—	Nylon roller	N

Style LC (to pass over switch cover)		
Arm	Catalog Number	Weight lb (kg)
Length		
1.50 (30)	LCA1	0.12 (0.054)
2.00 (50)	LCH1	0.12 (0.054)
2.50 (63)	LCO1	0.13 (0.059)

Style LC Options		
Diameter	Description	Catalog Number—Add Suffix
1.25 (32)	Roller	4
1.5 (38)	Roller	2
—	Nylon roller	N

Rolling Pin (for use with 2 step switches for conveyor or belt applications)		
Arm	Catalog Number	Weight lb (kg)
Length		
2.25 (75.1)	AL1650	0.30 (0.136)
2.25 (75.1)	AL16501	0.33 (0.150)
3.0 (50.8)	AL1802	0.33 (0.150)

Rolling Pin (adjustable)				
Arm	Steel roller	Width	Catalog Number	Weight lb (kg)
Length	Diameter			
2.00 (51) to 4.00 (102)	0.75 (19)	0.25 (6.3)	AL1650	0.30 (0.136)

♦ Example: KA — This is the complete catalog number to order.

Note: No hub component is needed for Type AL rolling pins. The arm mounts directly onto the shaft of the switch.

Dimensions:
page 238

Limit Switches

R.B.Denison® Lox-Switch™ L Severe Duty Mill and Foundry Switches

L100/L300 Options and Accessories



Mini Change Connector



Straight Male Connector



90° Angle Male Connector

Housing Options •

Description	Example	Catalog Number	Weight lb (kg)
	Full Catalog Number	Add Prefix	
0.75 in. conduit opening Available on 2 circuit switches. Standard on 3 circuit switches	L100WS2M1 changes to GL100WS2M1	G	1.54 (0.70)
High temperature 0 to +350 °F (-17.7 to +176.6 °C) ■ Metal front cover only	L100WS2M1 changes to HL100WS2M1	H	1.54 (0.70)
Low temperature -20 to 200 °F (-28.8 to +93.3 °C) ■	L100WS2M1 changes to TL100WS2M1	T	1.54 (0.70)
High shock Available only on operating sequences 1, 2, 4, 5, 7-11, 13, 14	L100WS2M1 changes to L526WS2M1	526	1.54 (0.70)
	L300WS2M1 changes to L326WS2M1	326	
Gold contacts	L100WS2M1 changes to L522WS2M1	522	1.54 (0.70)
	L300WS2M1 changes to L322WS2M1	322	
Metric conduit threads M20 (20 mm)	L100WS2M1 changes to ML100WS2M1	M	1.54 (0.70)

Wiring

Description	Example	Catalog Number	Weight lb (kg)
	Full Catalog Number	Add Prefix	
Straight male receptacle 4-pin ▲ Factory prewired	L100WS2M1 changes to PL100WS2M1	P	1.54 (0.70)
90° Angle male receptacle 4-pin ▲ Factory prewired—facing right	L100WS2M1 changes to APL100WS2M1	AP	1.54 (0.70)
Ministyle male receptacle † 8 A max. 5-pin (double circuit) or 7 A max. 7-pin (triple circuit)	L100WS2M1 changes to BL100WS2M1	B	1.54 (0.70)
Potted and prewired	Example	Add Suffix	Weight lb (kg)
5 wires 6 feet (1.8 mm) long	L100WS2M1 changes to L100WS2M1P	P	1.54 (0.70)
5 wires 12 feet (3.6 mm) long	L100WS2M1 changes to L100WS2M1P12	P12	
5 wires 18 feet (5.5 mm) long	L100WS2M1 changes to L100WS2M1P18	P18	

Front Covers

Description	Example	Catalog Number	Weight lb (kg)
	Full Catalog Number	Add Suffix	
Standard metal		M	—
Transparent plastic cover with metal frame		PF	—
Transparent plastic cover with metal frame and Neon indicator light (not connected)		GF	—
	L100WS2M1 changes to L100WS2PF 1		1.54 (0.70)

Accessories

Description		Catalog Number	Weight lb (kg)
Sealed female plug and cable for P and AP connector			
4 pin, #16 AWG STO cable 140 °F (60 °C)	4 ft. (1.21 m)	1010004	1.20 (0.54)
	6 ft. (1.82 m)	1010006	1.25 (0.57)
	10 ft. (3.04 m)	10100010	1.50 (0.68)
Sealed female plug and cable for ministyle connector (B)			
5 pin, #16 AWG STO cable 221 °F (105 °C)	3 ft. (0.91 m)	BH2053	1.50 (0.68)
	6 ft. (1.82 m)	BH2056	1.70 (0.77)
	12 ft. (3.65 m)	BH20512	2.10 (0.95)

- Other options available — contact your local field office for details.
- ▲ Receptacle is a 4-pin male APL/PL-SWTS, Cannon part # MS3102E20-4P-F79 or equal.
- † Ministyle male connectors are:
 - 5-pin: Brad Harrison #41310 (or equal)
 - 7-pin: Brad Harrison #42805 (or equal)
- The minimum temperatures listed are based on the absence of freezing moisture or water.

Limit Switches

R.B.Denison® Lox-Switch™ L Severe Duty Mill and Foundry Switches

Dimensions

Switches

Type L100

Type L300

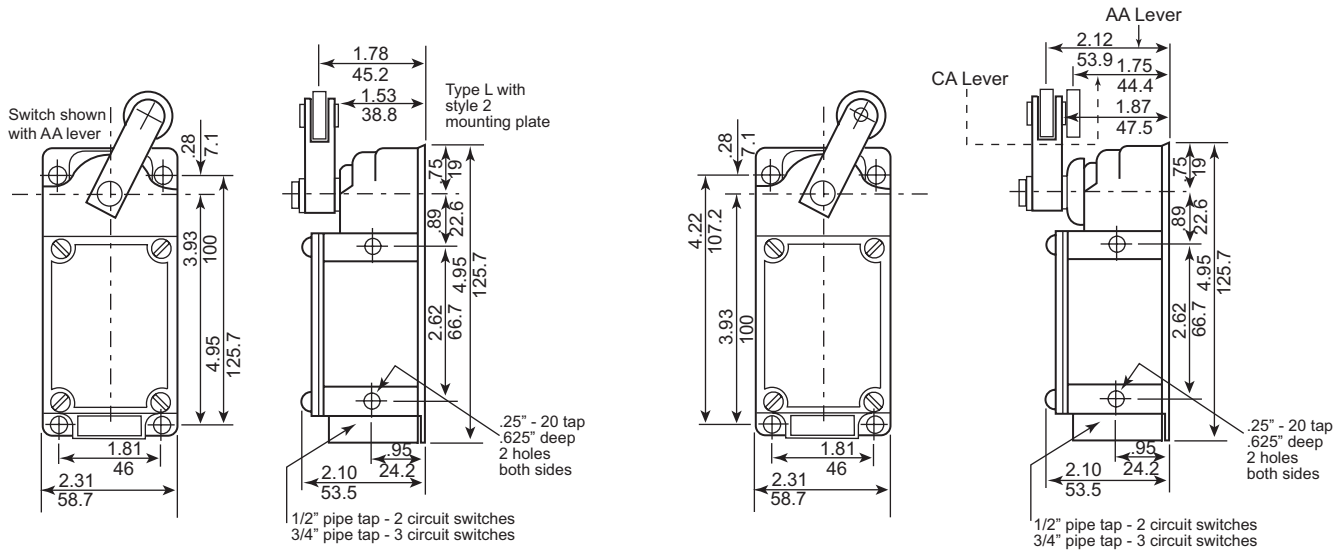

Base Plates

Style 1

Style 2

Style 3

Style 4

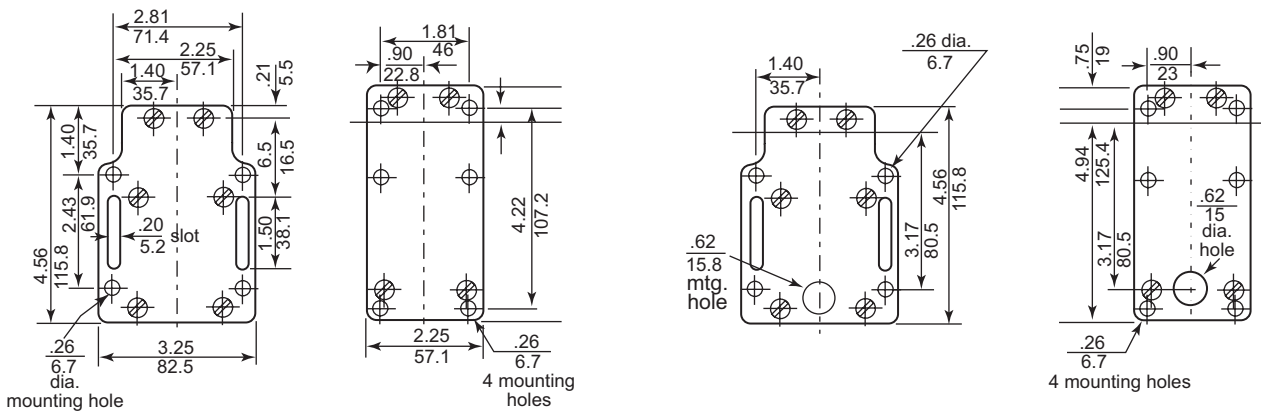

Receptacles

PL

APL

101000

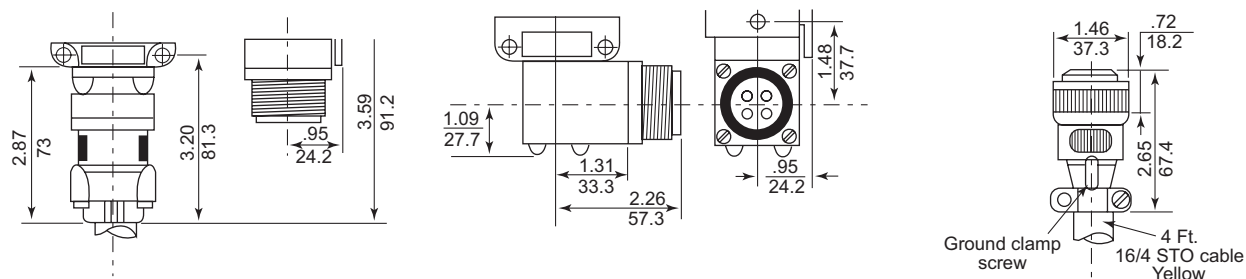

Dual dimensions: $\frac{\text{in.}}{\text{mm}}$

Limit Switches

Interpretation of Catalog Numbers

Severe Duty Mill and Foundry Switches

Interpretation of Catalog Numbers

The interpretation of catalog numbers is intended to help you understand how the catalog number is laid out. It is to be used with existing numbers only. The table below should not be used to generate new catalog numbers. If the contact sequence required is not listed, contact your local field office.

L100 and L300



Style	Housing			Function	Mounting Plate	Front Cover		Contact Arrangement	
L	1	0	0	W	S	2	P	F	
									1 to 60
Mill	100	L14" and L2153 pull cord switches			Style 1	1	M	Standard metal	
Foundry	300				Style 2	2	PF	Transparent plastic	
Belt Conveyor	525				Style 3	3	GF	Transparent plastic with neon light	
Two circuit single operation				WS	Style 4	4			
Two circuit dual operation				WD					
Triple circuit				WT					
Neutral				WN					

The only modifications to the existing catalog numbers are:

- Base Plates: Select style 1, 2, 3 or 4
- Front Covers: Select metal, transparent plastic, or transparent plastic with neon light.

For special features see page 237.

9007T and FT

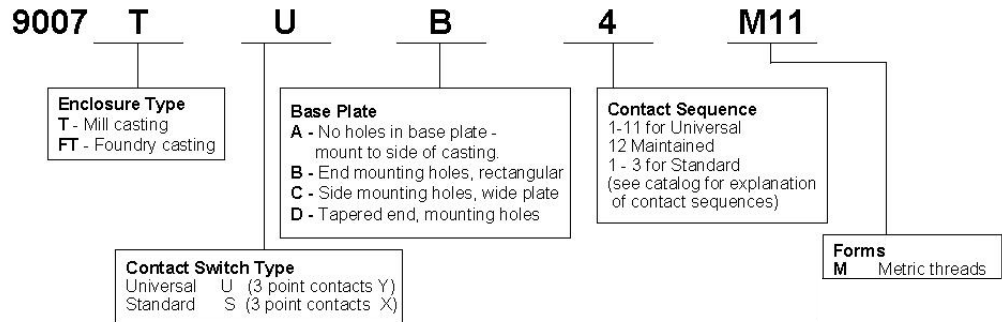

Limit Switches

Sensors, Limit Switches, and Connector Cables

Index

10100010	237	7XJ3N	157	9007C1	220	9007CA15	191
1010004	237	7XJ7N	157	9007C2	220	9007CA17	190
1010006	237	9007A	189	9007C3	220	9007CA18	190
2358C22G3	189	9007AAOS	192	9007C52**	9	9007CA18M	195
2358C22G6	189	9007AA1	190	9007C54***	9	9007CA1M	195
2358C22G8	189	9007AA11M	195	9007C54B2M11	177	9007CA1S	192
2358C6G2	189	9007AA17	190	9007C54B2P6	176	9007CA2	190
2358C6G3	189	9007AA18M	195	9007C54B2Y1901	178	9007CA2S	192
2358C6G6	189	9007AA1M	195	9007C54B2Y19019	178	9007CA3	193
2358C6G8	189	9007AA1S	192	9007C54B2Y1912	178	9007CA31	191
2934D14G1	221	9007AA2	190	9007C54DM11	177	9007CA3S	193
2934D32G1	221	9007AA2S	192	9007C54DP6	176	9007CA4	190
2934D33G1	221	9007AA5	191	9007C54DY1901	178	9007CA4S	192
2934D34G1	221	9007AA5M	195	9007C54DY19019	178	9007CA5	191
31032-488-01	181	9007AA6	191	9007C54DY1912	178	9007CA5M	195
31032-815-01	181	9007AA8	190	9007C54EM11	177	9007CA6	191
7A1	157	9007AA8M	195	9007C54EP6	176	9007CA8	190
7A1N	157	9007AA9	191	9007C54EY1901	178	9007CA8M	195
7A2	157	9007AA9M	195	9007C54EY19019	178	9007CA9	191
7A2N	157	9007B	189	9007C54EY1912	178	9007CA9M	195
7A3N	157	9007B1	220	9007C54FM11	177	9007CO52	188
7A4N	157	9007B12	220	9007C54FP6	176	9007CO54	188
7A7N	157	9007B13	220	9007C54FY1901	178	9007CO62	188
7B1N	157	9007B14	220	9007C54FY19019	178	9007CO66	188
7B2	157	9007B16	221	9007C54JM11	177	9007CO68	188
7B2N	157	9007B19	220	9007C54JP6	176	9007CR53**	9
7B3N	157	9007B2	220	9007C54JY1901	178	9007CR61**	9
7B4N	157	9007B21	220	9007C54JY19019	178	9007CR65**	9
7B7N	157	9007B22	220	9007C54JY1912	178	9007CR67**	9
7D	157	9007B23	220	9007C54LM11	177	9007CT10 (1)	181
7DN	157	9007B24	220	9007C54LP6	176	9007CT11	181
7F1N	157	9007B27	221	9007C54LY1901	178	9007CT12	181
7F2N	157	9007B3	220	9007C54LY19019	178	9007CT13 (2)	181
7F3N	157	9007B7	220	9007C54LY1912	178	9007CT52	188
7F4N	157	9007B8	220	9007C62***	9	9007CT54	188
7F7N	157	9007B9	220	9007C62B2M11	177	9007CT54	188
7J1N	157	9007BAOS	192	9007C62B2P6	176	9007CT62	188
7J2N	157	9007BA1	190	9007C62B2Y19016	178	9007CT62	188
7J3N	157	9007BA11	190	9007C62DM11	177	9007CT62	188
7J4N	157	9007BA11M	195	9007C62DP6	176	9007D	189
7J7N	157	9007BA12	190	9007C62DY19016	178	9007D1	220
7JX4N	157	9007BA13	190	9007C62EM11	177	9007D2	220
7N	157	9007BA15	191	9007C62EP6	176	9007D3	220
7S	157	9007BA17	190	9007C62EY19016	178	9007D4	221
7XA1	157	9007BA18	190	9007C62FM11	177	9007DA0S	192
7XA1N	157	9007BA18M	195	9007C62FP6	176	9007DA1	190
7XA2	157	9007BA1M	195	9007C62FY19016	178	9007DA11	190
7XA2N	157	9007BA1S	192	9007C62FY1912	178	9007DA11M	195
7XA3N	157	9007BA2	190	9007C62JM11	177	9007DA12	190
7XA4N	157	9007BA2S	192	9007C62JP6	176	9007DA13	190
7XA7N	157	9007BA3	193	9007C62JY19016	178	9007DA15	191
7XB1N	157	9007BA3S	193	9007C62LM11	177	9007DA17	190
7XB2	157	9007BA4	190	9007C62LP6	176	9007DA18	190
7XB2N	157	9007BA4S	192	9007C62LY19016	178	9007DA18M	195
7XB3N	157	9007BA5	191	9007C66***	9	9007DA1M	195
7XB4N	157	9007BA5M	195	9007C68***	9	9007DA1S	192
7XB7N	157	9007BA6	191	9007C84***	9	9007DA2	190
7XF1N	157	9007BA8	190	9007C86***	9	9007DA2S	192
7XF2N	157	9007BA8M	195	9007CA0S	192	9007DA3	193
7XF3N	157	9007BA9	191	9007CA1	190	9007DA31	191
7XF4N	157	9007BA9M	195	9007CA11	190	9007DA3S	193
7XF7N	157	9007BT1	181	9007CA11M	195	9007DA4	190
7XJ1N	157	9007BT3	181	9007CA12	190	9007DA4S	192
7XJ2N	157	9007C	189	9007CA13	190	9007DA5	191

Sensors, Limit Switches, and Connector Cables

Index

9007DA5M	195	9007FTUB4	218	9007KB15	193	9007TSB2	217
9007DA6	191	9007FTUB5	218	9007KC	189	9007TSB3	217
9007DA8	190	9007FTUB6	218	9007L	189	9007TSC1	217
9007DA8M	195	9007FTUB7	218	9007LA1	192	9007TSC2	217
9007DA9	191	9007FTUB8	218	9007LA10	192	9007TSC3	217
9007DA9M	195	9007FTUB9	218	9007LA11	192	9007TSD1	217
9007E	189	9007FTUC1	218	9007LA12	192	9007TSD2	217
9007E4	220	9007FTUC10	218	9007LA16	192	9007TSD3	217
9007E5	220	9007FTUC11	218	9007LA17	192	9007TUA1	216
9007E6	220	9007FTUC12	218	9007LA18	192	9007TUA10	216
9007EA0S	192	9007FTUC2	218	9007LA19	194	9007TUA11	216
9007EA1	190	9007FTUC3	218	9007LA2	192	9007TUA12	216
9007EA11	190	9007FTUC4	218	9007LA3	192	9007TUA2	216
9007EA11M	195	9007FTUC5	218	9007LA4	192	9007TUA3	216
9007EA12	190	9007FTUC6	218	9007LA5	192	9007TUA4	216
9007EA13	190	9007FTUC7	218	9007LA6	192	9007TUA5	216
9007EA15	191	9007FTUC8	218	9007LA7	192	9007TUA6	216
9007EA17	190	9007FTUC9	218	9007LA8	192	9007TUA7	216
9007EA18	190	9007FTUD1	218	9007LA9	192	9007TUA8	216
9007EA18M	195	9007FTUD10	218	9007MA1	190	9007TUA9	216
9007EA1M	195	9007FTUD11	218	9007MA11	190	9007TUB1	216
9007EA1S	192	9007FTUD12	218	9007MA11M	195	9007TUB10	216
9007EA2	190	9007FTUD2	218	9007MA12	190	9007TUB11	216
9007EA2S	192	9007FTUD3	218	9007MA13	190	9007TUB12	216
9007EA3	193	9007FTUD4	218	9007MA15	191	9007TUB2	216
9007EA3S	193	9007FTUD5	218	9007MA17	190	9007TUB3	216
9007EA4	190	9007FTUD6	218	9007MA18	190	9007TUB4	216
9007EA4S	192	9007FTUD7	218	9007MA18M	195	9007TUB5	216
9007EA5	191	9007FTUD8	218	9007MA18S	192	9007TUB6	216
9007EA5M	195	9007FTUD9	218	9007MA1M	195	9007TUB7	216
9007EA6	191	9007G	189	9007MA2	190	9007TUB8	216
9007EA8	190	9007G10	221	9007MA22	191	9007TUB9	216
9007EA8M	195	9007GD	189	9007MA3	193	9007TUC1	216
9007EA9	191	9007H	189	9007MA31	191	9007TUC10	216
9007EA9M	195	9007HA0	194	9007MA4	190	9007TUC11	216
9007ED	189	9007HA1	194	9007MA5	191	9007TUC12	216
9007F	189	9007HA2	194	9007MA5M	195	9007TUC2	216
9007F4	220	9007HA20	194	9007MA6	191	9007TUC3	216
9007F5	220	9007HA21	194	9007MA8	190	9007TUC4	216
9007F6	220	9007HA22	194	9007MA8M	195	9007TUC5	216
9007FA1	194	9007HA23	194	9007MA9	191	9007TUC6	216
9007FA2	193	9007HA24	194	9007MA9M	195	9007TUC7	216
9007FA3	194	9007HA25	194	9007N	189	9007TUC8	216
9007FA5	194	9007HA26	194	9007N1	220	9007TUC9	216
9007FA6	194	9007HA4	194	9007N2	220	9007TUD1	216
9007FT•••	11	9007HA5	194	9007R	189	9007TUD10	216
9007FTUA1	218	9007HA6	194	9007R16	221	9007TUD11	216
9007FTUA10	218	9007HA8	194	9007R17	221	9007TUD12	216
9007FTUA11	218	9007HA9	194	9007R18	220	9007TUD2	216
9007FTUA12	218	9007J	189	9007R19	220	9007TUD3	216
9007FTUA2	218	9007J1	220	9007R20	220	9007TUD4	216
9007FTUA3	218	9007J2	220	9007R21	221	9007TUD5	216
9007FTUA4	218	9007JJC	189	9007R22	221	9007TUD6	216
9007FTUA5	218	9007K	189	9007RA11	193	9007TUD7	216
9007FTUA6	218	9007K1	220	9007RA18	193	9007TUD8	216
9007FTUA7	218	9007K2	220	9007RA9	193	9007TUD9	216
9007FTUA8	218	9007KA1	193	9007S9	181	9007WJ	189
9007FTUA9	218	9007KA11	193	9007T•••	10	9007WK	189
9007FTUB1	218	9007KA12	193	9007T10	189	9007WKC	189
9007FTUB10	218	9007KA18	193	9007T5	189	9007X1	220
9007FTUB11	218	9007KA2	193	9007TSA1	217	9007X2	220
9007FTUB12	218	9007KA21	193	9007TSA2	217	9007Y1	220
9007FTUB2	218	9007KA9	193	9007TSA3	217	9007Y2	220
9007FTUB3	218	9007KB11	193	9007TSB1	217	9007Y3	221

Sensors, Limit Switches, and Connector Cables

Index

9007Z1	220	KO	235	L300WTL2M15	230	XCKD2101N12	74
9007Z2	220	L100***	10	L300WTLN1C2M39	231	XCKD2501G11	74
AA	234	L100WDL2M7	228	L300WTLN2M21	231	XCKD2501N12	74
AB	234	L100WDL2M8	228	L300WTLN2M41	231	XCKML	7
AB1R11	92	L100WDR2M4	228	L300WTR2M10	230	XCKP2101G11	74
AC	234	L100WDR2M5	228	L300WTR2M11	230	XCKP2101M12	74
AD	234	L100WDR2M6	228	L300WTR2M12	230	XCKP2101N12	74
AH	234	L100WN2M16	228	L300WTRN1C2M38	231	XCKP2501G11	74
AJ	234	L100WN2M17	228	L300WTRN2C2M40	231	XCKP2501N12	74
AK	234	L100WNC2M18	229	L300WTRN2CS2M48	231	XCKS	7
AL	234	L100WNCS2M34	229	L300WTRN2M20	231	XCKZ09	92
AL1649	235	L100WNS2M26	229	L525	10	XCMD2101C12	45
AL1650	236	L100WNSL2M29	229	L525WDL2M57	233	XCMD2101L1	45
AL1650	236	L100WNSR2M28	229	L525WDL2M58	233	XCMD2101M12	45
AL16501	236	L100WS02M22	229	L525WDR2M56	233	XCMD2501L1	45
AL1746	235	L100WS02M23	229	L525WDR2M59	233	XCMZ06	45
AL1802	236	L100WS0S2M60	233	LA01	236	XCMZ07	45
AM	234	L100WS2M1	228	LAA1	236	XCMZ07	74
AN	234	L100WS2M2	228	LAH1	236	XCR, XC1AC	7
AO	234	L100WS2M3	228	LCA1	236	XCRZ02	139
AP	234	L100WTL2M13	228	LCH1	236	XCRZ03	139
AQ	234	L100WTL2M14	228	LCO1	236	XCRZ04	139
AR	234	L100WTL2M15	228	M11	221	XCRZ05	139
BA	234	L100WTLN1C2M39	229	ML01S0100	156	XCRZ09	139
BB	234	L100WTLN2M21	229	ML02S0100	156	XCRZ09	141
BH	234	L100WTLN2M41	229	ML03S0100	156	XCRZ12	139
BH20-5-12	181	L100WTR2M10	228	ML04S0100	156	XCRZ15	139
BH20512	237	L100WTR2M11	228	ML06S0100	156	XCRZ42	141
BH20-5-3	181	L100WTR2M12	228	ML07S0100	156	XCRZ901	141
BH2053	237	L100WTRN1C2M38	229	ML08S0100	156	XCRZ902	141
BH20-5-6	181	L100WTRN2C2M40	229	ML09S0100	156	XCRZ903	141
BH2056	237	L100WTRN2CS2M48	229	ML10S0100	157	XE2N P2131	120
BM	234	L100WTRN2M20	229	ML12S0100	157	XE2N P2131	133
BN	234	L14	10	ML13S0100	157	XE2N P2141	120
BO	234	L142	232	MS01G0100	156	XE2N P2141	133
BQ	234	L143	232	MS01S0100	156	XE2N P2151	120
BR	234	L144	232	MS02G0100	156	XE2N P2151	133
CA	234	L145	232	MS02S0100	156	XE2N P2161	120
CB	234	L146	232	MS03G0100	156	XE2N P2161	133
CC	234	L147	232	MS03S0100	156	XE2NP2131	116
CD	234	L148	232	MS04G0100	156	XE2NP2131	119
CH	234	L149	232	MS04S0100	156	XE2NP2131	75
CL	234	L2153	11	MS05G0100	156	XE2NP2131	92
CM	234	L2153	232	MS05S0100	156	XE2NP2141	116
CO	234	L300***	11	MS06G0100	156	XE2NP2141	119
CR	234	L300WDL2M7	230	MS06S0100	156	XE2NP2141	75
DE9RA1012	74	L300WDL2M8	230	MS07G0100	156	XE2NP2141	92
DE9RA1212	133	L300WDR2M4	230	MS07S0100	156	XE2NP2151	92
DE9RA1212	139	L300WDR2M5	230	MS08G0100	156	XE2NP2151	116
DE9RA1212	141	L300WDR2M6	230	MS08S0100	156	XE2NP2151	119
DE9RA13520	139	L300WN2M16	230	MS09G0100	156	XE2NP2151	75
DE9RA13520	141	L300WN2M17	230	MS09S0100	156	XE2NP2161	116
EA	235	L300WNC2M18	231	MS10G0100	157	XE2NP2161	119
EB	235	L300WNCS2M34	231	MS10S0100	157	XE2NP2161	75
ED	235	L300WNS2M26	231	MS12G0100	157	XE2NP2161	92
FA	235	L300WNSL2M29	231	MS12S0100	157	XE2NP3131	75
FB	235	L300WNSR2M28	231	MS13G0100	157	XE2NP3141	75
FC	235	L300WS02M22	231	MS13S0100	157	XE2NP3151	75
FE	235	L300WS02M23	231	R	236	XE2NP3161	75
FG	235	L300WS2M1	230	R9	236	XE2S P2141	120
FI	235	L300WS2M2	230	VA	236	XE2S P2141	133
FJ	235	L300WS2M3	230	XALZ09	74	XE2S P2151	120
KA	235	L300WTL2M13	230	XCKD2101G11	74	XE2S P2151	133
KB	235	L300WTL2M14	230	XCKD2101M12	74	XE2SP2141	116

Sensors, Limit Switches, and Connector Cables

Index

XE2SP2141	119	XZCP1169L10	46	ZCK Z033	121	ZCKJ215H29	117
XE2SP2141	75	XZCP1169L2	46	ZCK Z034	121	ZCKJ21H29	111
XE2SP2141	92	XZCP1169L5	46	ZCKE055	118	ZCKJ21H29	114
XE2SP2151	92	XZCP1264L10	104	ZCKE056	115	ZCKJ25	117
XE2SP2151	116	XZCP1264L10	46	ZCKE065	118	ZCKJ25H29	117
XE2SP2151	119	XZCP1264L2	104	ZCKE066	115	ZCKJ2H29	110
XE2SP2151	75	XZCP1264L2	46	ZCKE085	118	ZCKJ2H29	114
XE2SP3151	75	XZCP1264L5	104	ZCKE086	115	ZCKJ4	110
XE3N P2141	120	XZCP1264L5	46	ZCKE095	118	ZCKJ4	114
XE3N P2141	133	XZCP1771L10	106	ZCKE096	115	ZCKJ404	111
XE3N P2151	120	XZCP1771L10	46	ZCKE215	118	ZCKJ4045	117
XE3N P2151	133	XZCP1771L2	106	ZCKE216	115	ZCKJ4045H29	117
XE3NP2141	75	XZCP1771L2	46	ZCKE235	118	ZCKJ4046	114
XE3NP2141	92	XZCP1771L5	106	ZCKE236	115	ZCKJ4046H29	114
XE3NP2151	75	XZCP1771L5	46	ZCKE615	118	ZCKJ404H29	111
XE3NP2151	92	Y147	180	ZCKE616	115	ZCKJ41	111
XE3S P2141	120	Y1561	180	ZCKE625	118	ZCKJ41	114
XE3S P2141	133	Y1841	179	ZCKE626	115	ZCKJ4104	111
XE3S P2151	120	Y1842	179	ZCKE635	118	ZCKJ41045	117
XE3S P2151	133	Y1843	179	ZCKE636	115	ZCKJ41045H29	117
XE3SP2141	75	Y1844	179	ZCKE645	118	ZCKJ41046	114
XE3SP2141	92	Y1851	179	ZCKE646	115	ZCKJ41046H29	114
XE3SP2151	92	Y1852	179	ZCKE655	118	ZCKJ4104H29	111
XE3SP2151	75	Y1853	179	ZCKE656	115	ZCKJ415	117
XEP, XCO	7	Y1854	179	ZCKE665	118	ZCKJ415H29	117
XEP3S1W2	28	Y1855	179	ZCKE675	118	ZCKJ41H29	111
XEP3S1W2B524	28	Y1856	179	ZCKE676	115	ZCKJ41H29	114
XEP3S1W2B529	28	Y1857	179	ZCKJ01	111	ZCKJ45	117
XEP3S1W3	28	Y1858	179	ZCKJ0121	121	ZCKJ45H29	117
XEP3S1W3B524	28	Y1901	178	ZCKJ0133	121	ZCKJ4H29	110
XEP3S1W3B529	28	Y19013	178	ZCKJ0134	121	ZCKJ4H29	114
XEP3S1W6	28	Y1903	178	ZCKJ02	111	ZCKJ5	110
XEP3S1W6B524	28	Y1905	178	ZCKJ04	111	ZCKJ5	114
XEP3S1W6B529	28	Y247	180	ZCKJ1	110	ZCKJ5	117
XEP3S2W2	28	Y249	180	ZCKJ1	114	ZCKJ520	112
XEP3S2W2B524	28	Y33	179	ZCKJ1	117	ZCKJ521	112
XEP3S2W2B529	28	ZC1AC001	148	ZCKJ11	111	ZCKJ521H29	112
XEP3S2W3	28	ZC1AC005	148	ZCKJ11	114	ZCKJ533	112
XEP3S2W3B524	28	ZC1AC006	148	ZCKJ1121	112	ZCKJ533H29	112
XEP3S2W3B529	28	ZC1AC007	148	ZCKJ1121H29	112	ZCKJ534	112
XEP3S2W6	28	ZC1AC008	148	ZCKJ1133	112	ZCKJ534H29	112
XEP3S2W6B524	28	ZC1AC009	148	ZCKJ1133H29	112	ZCKJ5D	113
XEP3S2W6B529	28	ZC1AZ11	148	ZCKJ1134	112	ZCKJ5H29	110
XEP4E1FD (3)	26	ZC1AZ12	148	ZCKJ1134H29	112	ZCKJ5H29	114
XEP4E1FDA326 (3)	26	ZC1AZ13	148	ZCKJ115	117	ZCKJ5H29	117
XEP4E1FDA454 (3)	26	ZC1AZ14	148	ZCKJ115H29	117	ZCKJ6	110
XEP4E1W7 (3)	26	ZC1AZ15	148	ZCKJ11H29	111	ZCKJ6	114
XEP4E1W7A326 (3)	26	ZC1AZ16	148	ZCKJ11H29	114	ZCKJ6	117
XEP4E1W7A454 (3)	26	ZC1AZ17	148	ZCKJ120	112	ZCKJ6D	113
XEP5P1W2 (3)	26	ZC1AZ8	148	ZCKJ121	112	ZCKJ6H29	110
XEP5P1W2Z55B (3)	26	ZCD21	72	ZCKJ121H29	112	ZCKJ6H29	114
XES P2021	120	ZCD25	72	ZCKJ133	112	ZCKJ6H29	117
XES P2031	120	ZCD26	72	ZCKJ133H29	112	ZCKJ7	110
XES P3021	133	ZCD27	72	ZCKJ134	112	ZCKJ7	114
XESP2021	116	ZCD28	72	ZCKJ134H29	112	ZCKJ7	117
XESP20215	119	ZCD29	72	ZCKJ1D	113	ZCKJ7D	113
XESP2031	116	ZCD31	72	ZCKJ1H29	110	ZCKJ7H29	110
XESP20315	119	ZCD35	72	ZCKJ1H29	114	ZCKJ7H29	114
XZCP1164L10	104	ZCD37	72	ZCKJ1H29	117	ZCKJ7H29	117
XZCP1164L10	46	ZCD39	72	ZCKJ2	110	ZCKJ8	110
XZCP1164L2	104	ZCE05	45	ZCKJ2	114	ZCKJ8	114
XZCP1164L2	46	ZCE05	74	ZCKJ21	111	ZCKJ8	117
XZCP1164L5	104	ZCK Z020	121	ZCKJ21	114	ZCKJ82A	121
XZCP1164L5	46	ZCK Z021	121	ZCKJ215	117	ZCKJ8D	113

Sensors, Limit Switches, and Connector Cables

Index

ZCKJ8H29	110	ZCKS9H29	132	ZCP27	72
ZCKJ8H29	114	ZCKSD31	132	ZCP28	72
ZCKJ8H29	117	ZCKSD31H29	132	ZCP29	72
ZCKJ9	110	ZCKSD35	132	ZCP31	72
ZCKJ9	114	ZCKSD35H29	132	ZCP35	72
ZCKJ9	117	ZCKSD37	132	ZCP37	72
ZCKJ902	121	ZCKSD37H29	132	ZCP39	72
ZCKJ903	121	ZCKSD39	132	ZCT21G11	73
ZCKJ904	121	ZCKSD39H29	132	ZCT21N12	73
ZCKJ906	121	ZCKY11	116	ZCT21P16	73
ZCKJ9H29	110	ZCKY115	119	ZCT25G11	73
ZCKJ9H29	114	ZCKY13	116	ZCT25N12	73
ZCKJ9H29	117	ZCKY13	119	ZCT25P16	73
ZCKJD31	110	ZCKY14	116	ZCT26G11	73
ZCKJD31H29	110	ZCKY14	119	ZCT26N12	73
ZCKJD35	110	ZCKY41	116	ZCT26P16	73
ZCKJD35H29	110	ZCKY415	119	ZCT27G11	73
ZCKJD37	110	ZCKY43	116	ZCT27N12	73
ZCKJD37H29	110	ZCKY43	119	ZCT27P16	73
ZCKJD39	110	ZCKY51	116	ZCT28G11	73
ZCKJD39H29	110	ZCKY51	119	ZCT28N12	73
ZCKL1	90	ZCKY52	116	ZCT28P16	73
ZCKL5	90	ZCKY52	119	ZEP3L524	28
ZCKL6	90	ZCKY53	116	ZEP3L529	28
ZCKL7	90	ZCKY53	119	ZEP4L326 (3)	26
ZCKL8	90	ZCKY59	116	ZEP4L454 (3)	26
ZCKLD31	91	ZCKY61	116		
ZCKLD35	91	ZCKY615	119		
ZCKLD37	91	ZCKY71	116		
ZCKLD39	91	ZCKY715	119		
ZCKM1	90	ZCKY81	116		
ZCKM1H29	90	ZCKY91	116		
ZCKM5	90	ZCMC21E1	44		
ZCKM5H29	90	ZCMC21E10	44		
ZCKM6	90	ZCMC21E2	44		
ZCKM6H29	90	ZCMC21E3	44		
ZCKM7	90	ZCMC21E5	44		
ZCKM7H29	90	ZCMC21E7	44		
ZCKM8	90	ZCMC21L1	43		
ZCKM8H29	90	ZCMC21L10	43		
ZCKM9H29	90	ZCMC21L2	43		
ZCKMD31	91	ZCMC21L3	43		
ZCKMD31H29	91	ZCMC21L5	43		
ZCKMD35	91	ZCMC21L7	43		
ZCKMD35H29	91	ZCMC25L1	43		
ZCKMD37	91	ZCMC25L10	43		
ZCKMD37H29	91	ZCMC25L2	43		
ZCKMD39	91	ZCMC25L3	43		
ZCKMD39H29	91	ZCMC25L5	43		
ZCKS1	132	ZCMC25L7	43		
ZCKS1H29	132	ZCMD61	44		
ZCKS2	132	ZCMD61C12	45		
ZCKS2H29	132	ZCMD61M12	45		
ZCKS404	132	ZCMD65	44		
ZCKS404H29	132	ZCMD69	44		
ZCKS5	132	ZCMD69C12	45		
ZCKS5H29	132	ZCMD77	44		
ZCKS6	132	ZCMD79	44		
ZCKS6H29	132	ZCMD81L1	44		
ZCKS7	132	ZCMD81L2	44		
ZCKS7H29	132	ZCMD81L5	44		
ZCKS8	132	ZCP21	72		
ZCKS8H29	132	ZCP25	72		
ZCKS9	132	ZCP26	72		

Schneider Electric USA

8001 Knightdale Blvd.
Knightdale, NC 27545
1-888-Square D
1-888-778-2733
www.us.SquareD.com

9007CT0501 © 1997–2006 Schneider Electric All Rights Reserved

03/2007