

High-Precision Switch for Detecting Micron Unit Displacement

- 1-micron or 3-micron repeat accuracy
- Ideal for detecting and measuring wear of cutting tools or the original point of work
- 24 VDC solid state output or 12 VDC/ 24 VAC contact output
- Solid state output model has LED indicator for ease of monitoring operation
- M16 and limit switch body types available with M12 quick disconnect for easy installation and maintenance





## Ordering Information

### ■ SWITCH

#### Contact Output Models (Without Operation Indicator)

Actuator	Body Type	Repeat accuracy	Operating force	Cable lead outlet		Degree of protection	Part number
				Type	Length		
<b>Pin plunger</b> 	M5	1 μm max.	0.29 N max.	Prewired	1 m	IP40	D5A-1100
			0.49 N max.				D5A-1200
		3 μm max.	0.29 N max.				D5A-2100
			0.49 N max.				D5A-2200
	M8	1 μm max.	0.49 N max.			IP67	D5A-3200
			0.98 N max.				D5A-3300
	M16	3 μm max.	2.45 N max.			D5A-7400	
			Connector			D5A-7403	

#### Solid-State PNP Output Models (With Operation Indicator)

Actuator	Body Type	Repeat accuracy	Operating force	Cable lead outlet		Degree of protection	Part number	
				Type	Length			
<b>Pin plunger</b> 	M8	1 μm max.	0.49 N max.	Prewired	1 m	IP67	D5A-3210	
			0.98 N max.				D5A-3310	
			Slim				0.49 N max.	D5A-5210
							0.98 N max.	D5A-5310
	M16	3 μm max.	2.45 N max.				D5A-7410	
			Connector				D5A-7413	
<b>Top plunger</b> 	Limit	3 μm max.	3.92 N max.	Prewired	3 m	D5A-8511		
					5 m	D5A-8512		
				Connector	3 m	D5A-8514		
					5 m	D5A-8515		
				<b>Bevel plunger</b> 	Prewired	3 m	D5A-9511	
						5 m	D5A-9512	
						Connector	3 m	D5A-9514
							5 m	D5A-9515

# Specifications

## ■ RATINGS

Contact output models	10 mA at 24 VAC, 10 mA at 12 VDC
Solid-state output models	100 mA at 5 to 24 VDC $\pm$ 10% Leakage current: 0.15 mA max. Residual voltage: 3 V max. Power consumption: 3 mW max.

## ■ CHARACTERISTICS

Degree of protection	D5A-1□, D5A-2□: IP40 Other than the above models: IP67
Repeat accuracy (See Note 2.)	M5 (D5A-1□□□ series), M8, slim type: 1 $\mu$ m max. M5 (D5A-2□□□ series), M16, limit type: 3 $\mu$ m max.
Life expectancy (See Note 3.)	Mechanical: 10,000,000 operations min. Malfunction: 1,000,000 operations min. (under rated load)
Deviation in electrical life expectancy after 1,000,000 operations	M5, M8, M16, slim type: 10 $\mu$ m max. Limit type: 20 $\mu$ m max.
Operating speed	1 $\mu$ m to 0.5 m/s
Rated frequency	50/60 Hz
Insulation resistance	100 M $\Omega$ min. (at 250 VDC) between each terminal and ground
Contact resistance	800 m $\Omega$ max. (initial) with 1 m cable, 2.4 $\Omega$ max. (initial) with 3 m cable, 4 $\Omega$ max. (initial) with 5 m cable)
Dielectric strength	1,000 VAC, 50/60 Hz for 1 min between each terminal and ground
Vibration resistance	Malfunction: 10 to 55 Hz, 1.5-mm double amplitude
Shock resistance	Mechanical: 1,000 m/s <sup>2</sup> min. Malfunction: 300 m/s <sup>2</sup> min.
Temperature coefficient (See Note 4.)	M5, M8, slim type: $\pm$ 20 x 10 <sup>-6</sup> /°C max. M16 type: $\pm$ 40 x 10 <sup>-6</sup> /°C max. Limit type: $\pm$ 50 x 10 <sup>-6</sup> /°C max.
Ambient temperature	Operating: -20°C to 75°C (-4°F to 167°F) with no icing
Ambient humidity	Operating: 30% to 85% (30% to 95% with the seal rubber)

**Note:** 1. The above figures are initial values.

- Contact your OMRON sales representative for measurement conditions of the repeat accuracy.
- Life expectancy values are calculated at an operating temperature of 5°C to 35°C, and an operating humidity of 40% to 70%. Contact your OMRON sales representative for more detailed information on other operating environments.
- The value indicates the operating position change rate for a change of 1°C in the ambient temperature.

## ■ OPERATING CHARACTERISTICS

Model	D5A-1100 D5A-2100 (See Note 2.)	D5A-1200 D5A-2200 (See Note 2.)	D5A-3200 D5A-3210 (See Note 2.)	D5A-3300 D5A-3310 (See Note 2.)	D5A-5210 (See Note 2.)	D5A-5310 (See Note 2.)
OF max.	0.29 N	0.49 N	0.49 N	0.98 N	0.49 N	0.98 N
OT min.	1.5 mm	1.5 mm	1.5 mm	1.5 mm	1.5 mm	1.5 mm
MD max.	5 $\mu$ m	5 $\mu$ m	5 $\mu$ m	5 $\mu$ m	5 $\mu$ m	5 $\mu$ m
OP (See Note 1.)	(2 mm)	(2 mm)	(6.5 mm)	(6.5 mm)	10.5 $\pm$ 0.4 mm	10.5 $\pm$ 0.4 mm

Model	D5A-7400/-7410 D5A-7403/-7413	D5A-8511/-8514 D5A-8512/-8515	D5A-9511/-9514 D5A-9512/-9515
OF max.	2.45 N	3.93 N	
PT max.	1 mm	1 mm	
OT min.	2 mm	5 mm	4 mm
MD max.	5 $\mu$ m	5 $\mu$ m	5 $\mu$ m
OP	(4.4 mm)	21.0 $\pm$ 0.4 mm	15.2 $\pm$ 0.4 mm
FP	(5 mm)	(21.8 mm)	(15.8 mm)

**Note:** 1. The operating position of these types is the same as the free position because of high sensitivity (repeat accuracy: 1  $\mu$ m max.).

- Total movement is 1.9 to 2.1 mm. Set the appropriate stroke (plunging depth) to 1.0 to 1.5 mm from the FP.

# Operation

## ■ ACTUATOR DEFINITIONS

Unit: mm (inch)

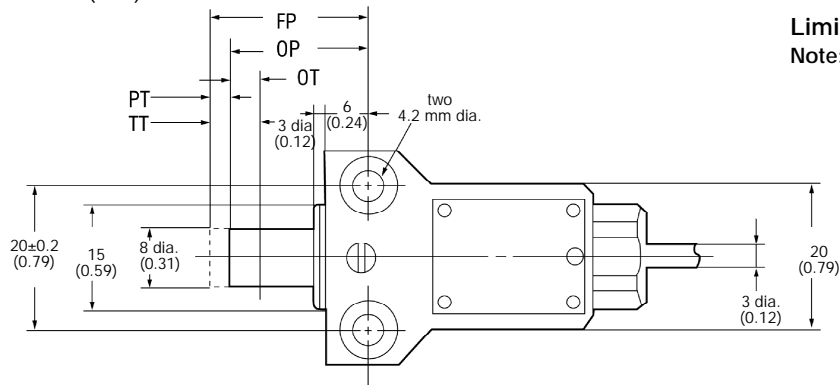

### Limit Switch Body Styles

**Note:** For M5, M8, M16 and slim body types, the free position is the same as the operating position, eliminating the pretravel distance.

- **FP** (Free Position) — the position of the actuator (or its distance traveled) when *no* external force is applied.
- **MD** (Movement Differential) — the distance (or angle) from the operating position to the releasing position.
- **OF** (Operating Force) — the force applied to the actuator (i.e., the force required to operate the switch contacts).
- **OP** (Operating Position) — the actuator position when the contacts snap to the operated contact position.
- **OT** (Overtravel) — the distance (or angle) of actuator movement beyond the operating position.
- **PT** (Pretravel) — the distance (or angle) of actuator movement from the free position to the operating position.
- **RF** (Releasing Force) — the value that the actuator force must be *reduced to* so that the contacts can return to the normal position.
- **RP** (Releasing Position) — the actuator position when the contacts snap from the operating *contact position* to their normal position.
- **TT** (Total Travel) — the sum of the pretravel and the total overtravel expressed as a distance or an angle.
- **TTP** (Total Travel Position) — the actuator position when it reaches the stopper.

## ■ CONTACT FORM/OUTPUT CIRCUIT DIAGRAM

### Contact Output Models

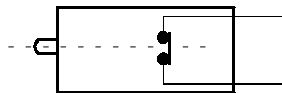

## ■ SOLID-STATE OUTPUT MODELS

### PNP Transistor Output

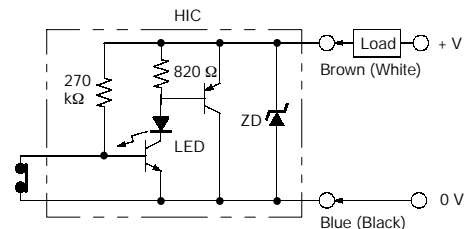

- Note:**
1. HIC (hybrid integrated circuit)
  2. An LED current limit resistor is incorporated.
  3. The ZD absorbs surge.
  4. The load can be connected to either the +V side or 0V side.

# Dimensions

Unit: mm (inch)

**Note:** Unless specified with the dimension, a tolerance of  $\pm 0.4$  mm applies to all dimensions.

## ■ M5 TYPE (CONTACT OUTPUT)

D5A-1100, D5A-2100, D5A-1200, D5A-2200

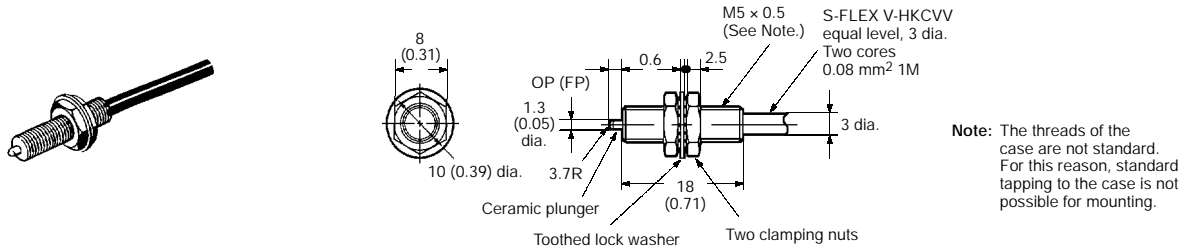

## ■ M8 TYPE (SOLID-STATE OUTPUT)

D5A-3210, D5A-3310

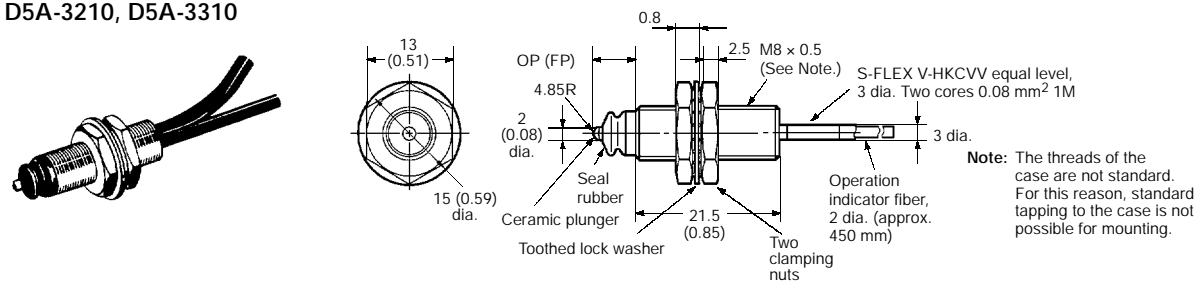

## ■ M8 TYPE (CONTACT OUTPUT)

D5A-3200, D5A-3300

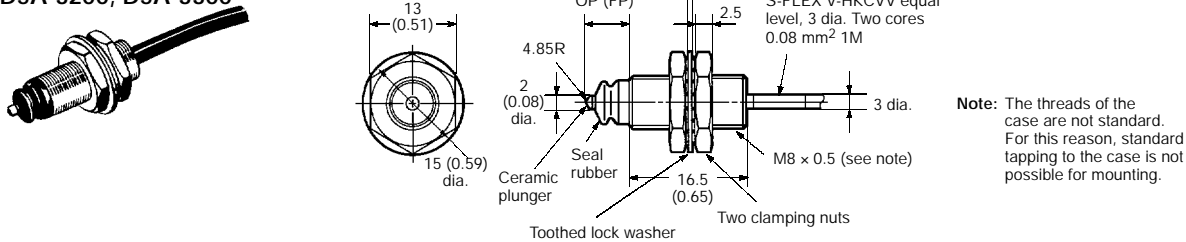

## ■ SLIM TYPE (SOLID-STATE OUTPUT)

D5A-5210, D5A-5310

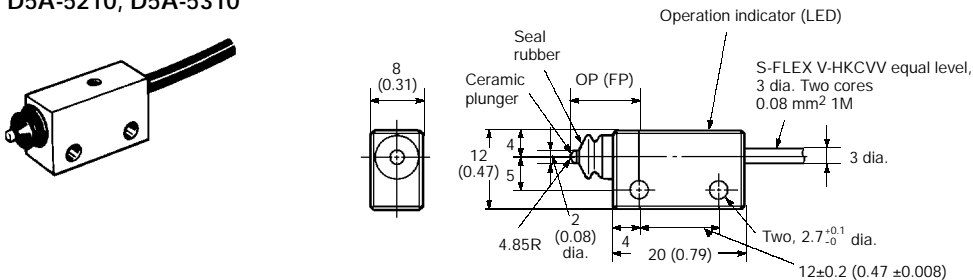

■ M16 TYPE (CONTACT OUTPUT/SOLID-STATE OUTPUT)

D5A-7400, D5A-7410

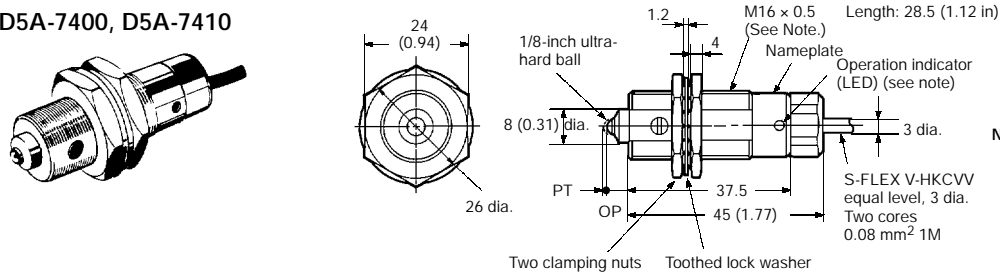

Note: Not available in the contact output type.

■ M16 TYPE (CONTACT OUTPUT/SOLID-STATE OUTPUT)

D5A-7403, D5A-7413  
(Connector Type)

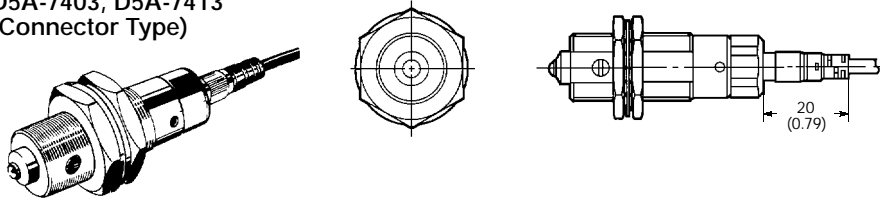

Note: The dimensions are the same as those in the model above.

■ LIMIT TYPE (SOLID-STATE OUTPUT)

D5A-8511, D5A-8512

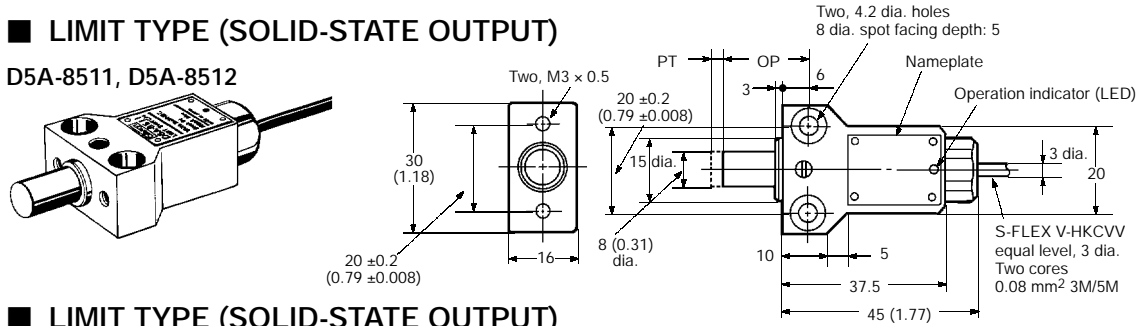

■ LIMIT TYPE (SOLID-STATE OUTPUT)

D5A-8514, D5A-8515  
(Connector Type)

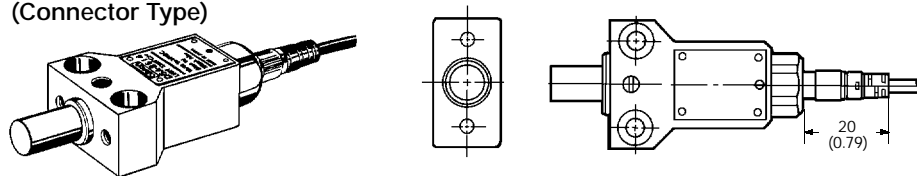

Note: The dimensions are the same as those in the model above.

■ LIMIT TYPE (SOLID-STATE OUTPUT)

D5A-9511, D5A-9512

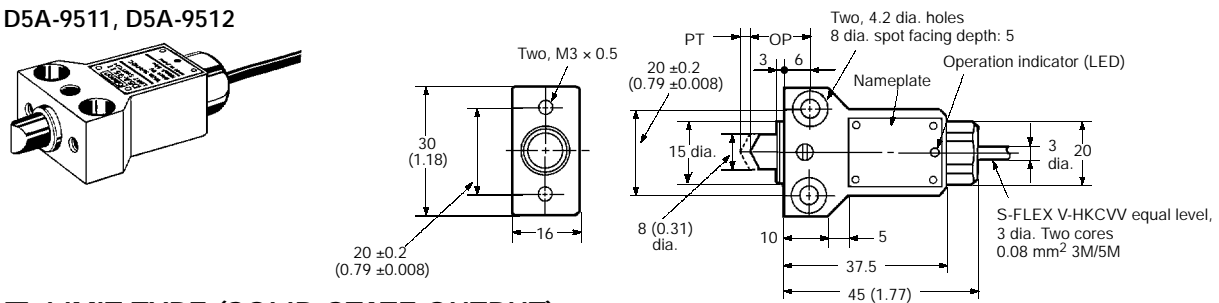

■ LIMIT TYPE (SOLID-STATE OUTPUT)

D5A-9514, D5A-9515  
(Connector Type)

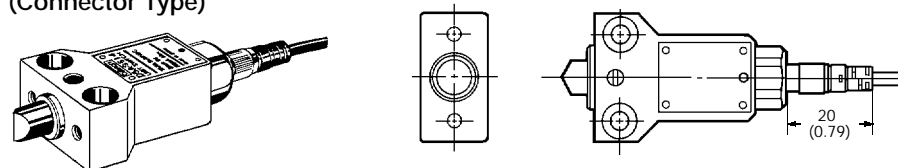

Note: The dimensions are the same as those in the model above.

# Engineering Data

## REPEAT ACCURACY EXAMPLES

**Note:** Each switch is supplied with actual repeat accuracy test results when shipped.

In reading the follow graphs, use this key.

- OP = Operating Position
- RP = Releasing Position

### M5 Type (Contact Output) with Repeat Accuracy of 1 $\mu\text{m}$ max.

D5A-1□□□ Series

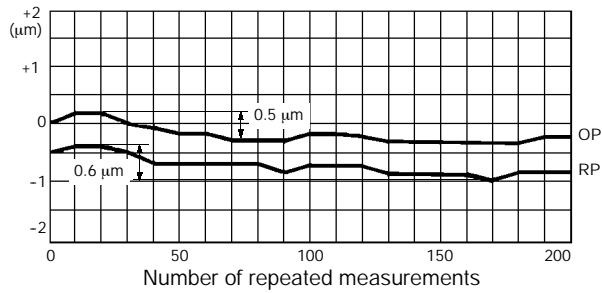

### M5 Type (Contact Output) with Repeat Accuracy of 3 $\mu\text{m}$ max.

D5A-2□□□ Series

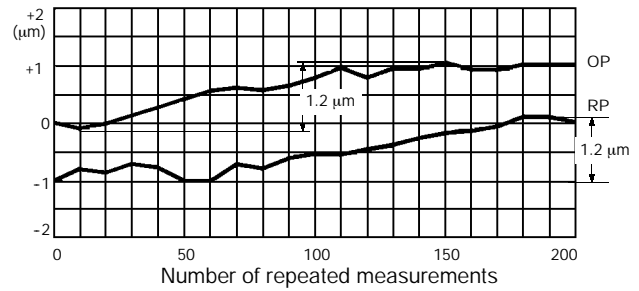

### M8 Type (Contact/Solid-state Output) with Repeat Accuracy of 1 $\mu\text{m}$ max.

D5A-3□□□ Series

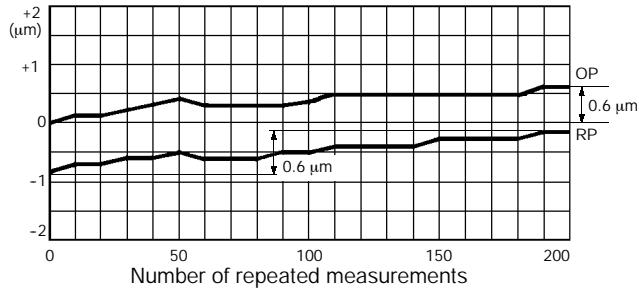

### M16 Type (Contact/Solid-state Output) with Repeat Accuracy of 3 $\mu\text{m}$ max.

D5A-7□□□ Series

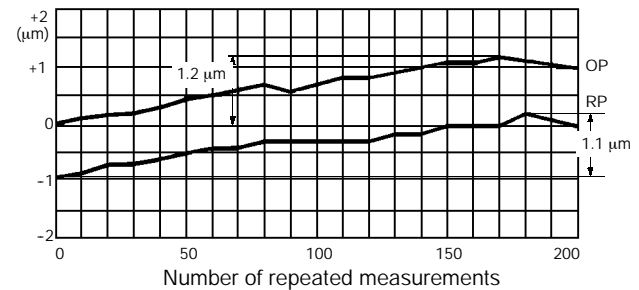

### Slim Type (Solid-state Output) with Repeat Accuracy of 1 $\mu\text{m}$ max.

D5A-5□□□ Series

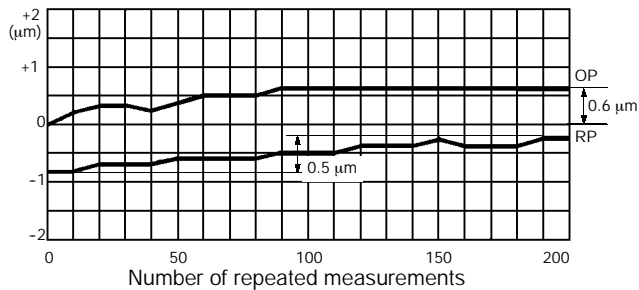

### Limit Type (Solid-state Output) with Repeat Accuracy of 3 $\mu\text{m}$ max.

D5A-8□□□ Series, D5A-9□□□ Series

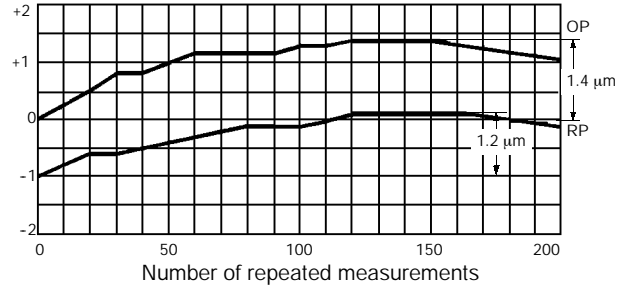

## Precautions

### ■ HANDLING OF FIBER CABLE

Do not pull or impose any force exceeding 29.42 N on the fiber cable.

Make sure that the bending radius of the fiber cable is as large as possible and at least 25 mm.

The 40-mm portion of the fiber cable on the connector end as shown below must not be bent.

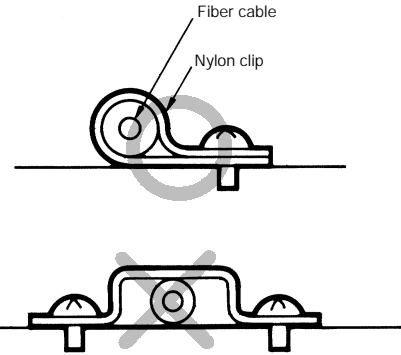
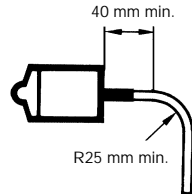

The fiber cable can be cut with OMRON's E39-F4 Cutting Tool.

Do not impose any force exceeding 29.42 N on the cable, or the cable may break. Make sure that the bending radius of the cable is at least 20 mm.

Do not impose compressing loads on the fiber cable.

### ■ MOUNTING

For the mounting dimensions, refer to the following figures and tables.

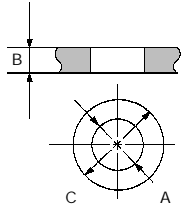

Dimensions		M5	M8		M16
			Contact output	Solid-state output	
A	Mounting hole	5.2±0.1 mm dia.	8.2±0.1 mm dia.		16.2±0.1 mm dia.
B	Panel thickness	3 to 10 mm	5 to 8 mm	5 to 13 mm	10 to 17 mm
C	Toothed lock washer	10 mm dia.	15 mm dia.		26 mm dia.

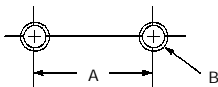

Dimensions		Slim	Limit
A	Mounting pitch	12±0.2 mm	20±0.2 mm
B	Tapping	M2.6	M4
	Mounting hole	2.8 <sup>+0.2</sup> <sub>-0</sub> mm dia.	4.2 <sup>+0.2</sup> <sub>-0</sub> mm dia.

**Note:** Do not tighten the nut with too much force. Be sure to apply the clamping torque shown in this table.

Type	Clamping torque
M5	0.98 N • m max.
M8	2.94 N • m max.
M16	9.81 N • m max.
Slim	0.29 N • m max. (M2.6 screw)
Limit	1.47 N • m max. (M4 screw)

When mounting the switch to a panel, be sure to use a toothed lock washer (included with M5, M8, and M16 types only). Use the washer on the panel surface opposite the object to be detected by the switch.

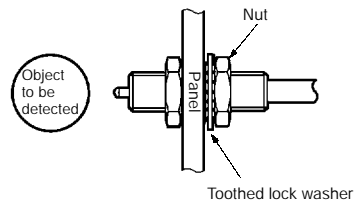

## ■ MOUNTING ALIGNMENT

Adjust the mounting of the D5A until the stroke of the pin plunger is aligned with the stroke of the operating body. Special attention should be paid to the ceramic pushbutton unit. It might be damaged if undue shock is applied.

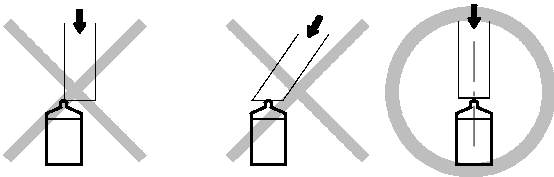

The harder the material for the dog and the more solidly the mounting base is fitted, the more accurately a minute displacement is detected.

When a limit switch type is used, apply grease to the dog to reduce friction between it and the plunger. Do not apply grease to pin plungers, or the grease may stick to the contacts or generate gas that may cause contact failures.

Be sure to use dogs made of hard materials for bevel or top plungers and apply grease to the surface of the dogs. The hardness (Hv) of a bevel plunger is 2,000 or over, for which it is recommended that a dog that has an Hv value of 1,000 or less be used.

Do not fail to provide a stopper so as to prevent the enclosure of the D5A from being used as the stoppers.

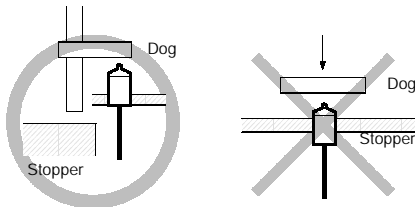

Attach an appropriate cover for the protection of the D5A from machining oil or cuttings. No protective cover is, however, provided together with the Switch.

Exercise care that excessive force is not applied to the ceramic plunger of M5, M8, or slim type. If the possibility exists that strong shock may be applied to the plunger when the Switch is being mounted, use a protective cap.

The plunger may not release if it is depressed with too great a force. Set its stroke by referring to the OT value indicated in *Operating Characteristics*.

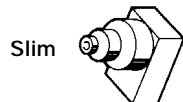

Do not mount the Switch with its nameplate facing downwards (i.e., in the direction of gravity), otherwise the oil drain hole will not work effectively.

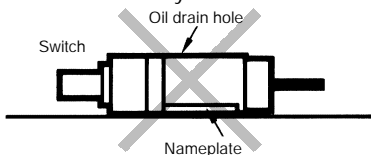

## ■ CONNECTION OF CONTACT OUTPUT

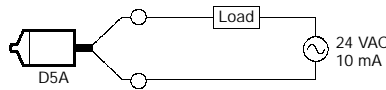

## ■ CONNECTION OF SOLID-STATE OUTPUT

Be sure to connect the load to the power source in series.

The operating state of the Switch can be checked by the LED operation indicator (illuminants when the Switch is in operation) incorporated in the solid-state output circuit.

The output residual voltage is approximately 3 V. For this reason, exercise care when selecting the load and setting the supply voltage. The residual voltage, however, can be easily calculated because it is almost constant and is free from the influence of fluctuation in the load current.

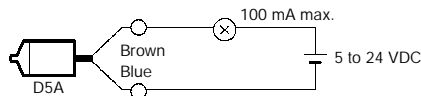

### Example:

- In the above circuit, suppose the MY relay rated at 12 VDC is used as the load. Since the must operate voltage of the relay is 80% or less than the rated voltage, it is  $12 \times 0.8 = 9.6$  V. The supply voltage, in turn, is  $3 + 9.6 = 12.6$  V. For this reason, the relay may not operate with a 12 V power source.
- However, if the relay rated at 24 VDC is employed, the must operate voltage and supply voltage of the relay are respectively 19.2 V and 22.2 V. The relay therefore can operate with a 24 V power source.

When a solid-state circuit is turned OFF, leakage current of 0.15 mA (max.) flows, causing some voltages to remain in the load. For this reason, be sure to check the must release voltage of the load before using it.



## ■ SERIES CONNECTION OF SWITCHES

The Solid-state Output-type Switches must not be connected in series. To obtain the same effect as a series connection, form an AND gate with a relay inserted between the Switch and load.

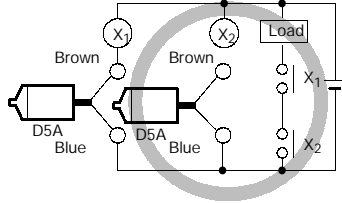
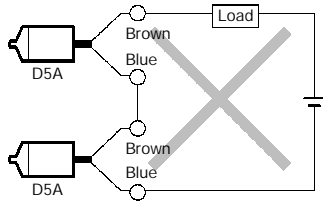

## ■ CONNECTION TO POWER SOURCE

Be sure to connect the Switch to the power source via the load. If directly connected to the power source, the internal elements of the Switch may be damaged.

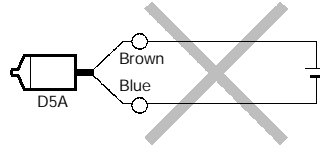

Correctly connect the white and black lead wires to the positive and negative sides, respectively, of the power source. Although the D5A will not be damaged even if the polarity is reversed by mistake, if this happens, the Switch maintains the ON state (i.e., the contact is kept open) regardless of the presence or absence of the object to be detected.

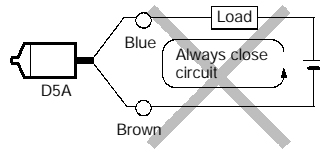

## ■ PARALLEL CONNECTION OF SWITCHES

In principle, two or more D5A's should not be used in an OR configuration.

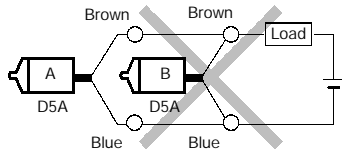

However, they can be connected in parallel provided that both switches A and B in the above figure do not operate at the same time and that the load does not have to be kept energized. In this circuit, however, the leakage current is increased, multiplied by the number of Switches connected in parallel. Consequently, the Switch may not release properly. To keep the load energized, connect a relay to each of the Switches as shown below.

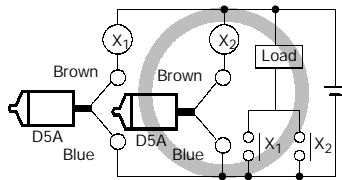

**NOTE: DIMENSIONS SHOWN ARE IN MILLIMETERS. To convert millimeters to inches divide by 25.4.**

# OMRON®

OMRON ELECTRONICS LLC  
One East Commerce Drive  
Schaumburg, IL 60173  
**1-800-55-OMRON**

### OMRON ON-LINE

Global - <http://www.omron.com>  
USA - <http://www.omron.com/oei>  
Canada - <http://www.omron.com/oci>

### OMRON CANADA, INC.

885 Milner Avenue  
Scarborough, Ontario M1B 5V8  
**416-286-6465**