

Panasonic

ideas for life

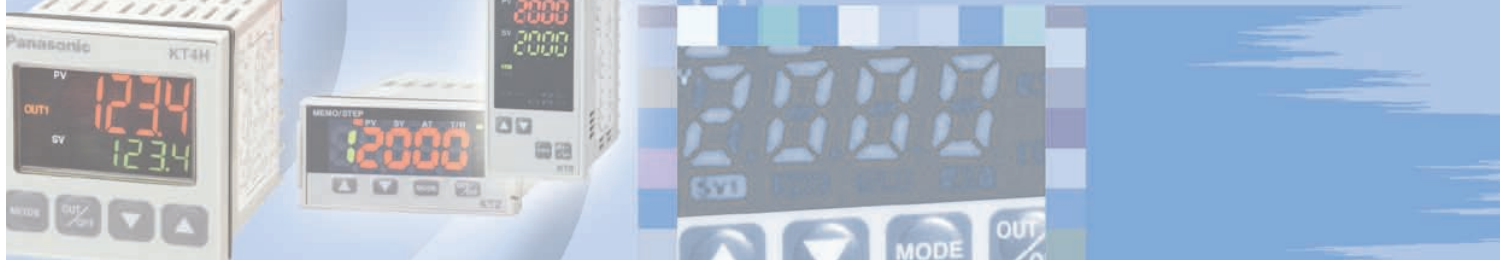

KT Series Temperature Controller



KT Series

Overview



Common Features

- ▶ Multi-input: Versatile thermocouple, RTD, DC Current, DC Voltage
- ▶ Control modes: PID, on/off control, Anti-Reset-Windup (ARW)
- ▶ Control output: Relay, non-contact voltage output (for SSR drive, DC current output)
- ▶ Accuracy: $\pm 0.2\%$ span
- ▶ Simple operation
- ▶ Heater-burn-out alarm available
- ▶ Alarm output with 9 different operation modes
- ▶ RS485 ASCII/Modbus communication available
- ▶ Supply voltage: 24V AC/DC or 100 to 240V AC
- ▶ Compliant with UL, CSA standards and CE marking

Multi-input:

- ▶ Thermocouples K, J, R, S, B, E, T, N, PL-II, C(W/Re5-26)
- ▶ RTD Pt100, JPt100, 3-conductor system
- ▶ DC current 0/4 - 20mA
- ▶ DC Voltage 0 to 1V, 0 to 5V, 1 to 5V, 0 to 10V

Application examples:

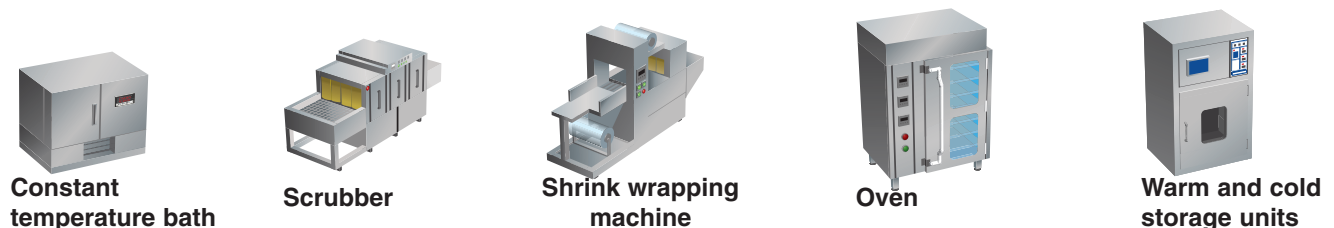

Output Methods:

Output method	Characteristics
Relay contact output	Relay contact output is used for switching up to 3A 250V AC (resistive load) in applications in which the on-off frequency is low.
Voltage output for SSR drive	This voltage output is used for driving the SSR . Since the SSR is a semiconductor relay, contact life is long. This type is used in applications in which the on-off frequency is high. Up to 40mA 12V DC can be switched.
DC current output	This current output is used to control a power regulator. Smooth and accurate control is possible because phase control corresponds to the current output.

KT Series

Display and Operation

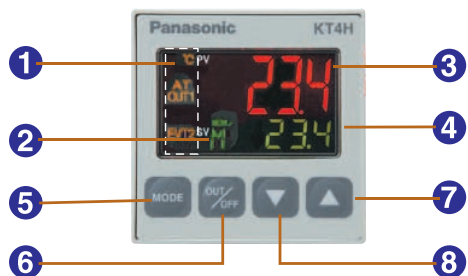

1 Indicators (backlight: orange)

- °F °C** Lights up respectively when temperature unit F°/C° is selected.
- T/R** Light ups during serial communication (option) TX output.
- AT** Flashes during auto-tuning or auto-reset.
- OUT1** Lights up when control output is ON or Heating output (option) is ON.
For DC current output type, it flashes corresponding to the manipulated variable in 0.25 second cycles.
- OUT2** Lights up when Cooling output (option) is ON.
- EVT1** Lights up when Alarm 1 output is ON.
- EVT2** Lights up when Alarm 2 output (option) is ON or Heater burnout alarm (option) is ON.
- LOCK** Lights up when Lock 1, Lock 2 or Lock 3 is selected.
- 2 MEMO display** Indicates the set value memory number (backlight: green).
- 3 PV display** Indicates the PV (process variable) (backlight: red/orange/green).
- 4 SV display** Indicates the SV (set value) (backlight: green).
- 5 Mode key** Selects the setting mode and registers the set value.
- 6 OUT/OFF key** Switches the control output ON or OFF and selects Auto/Manual control.
- 7 Increase key** Increases the numeric value.
- 8 Decrease key** Decreases the numeric value.

KT2 display and operation features:

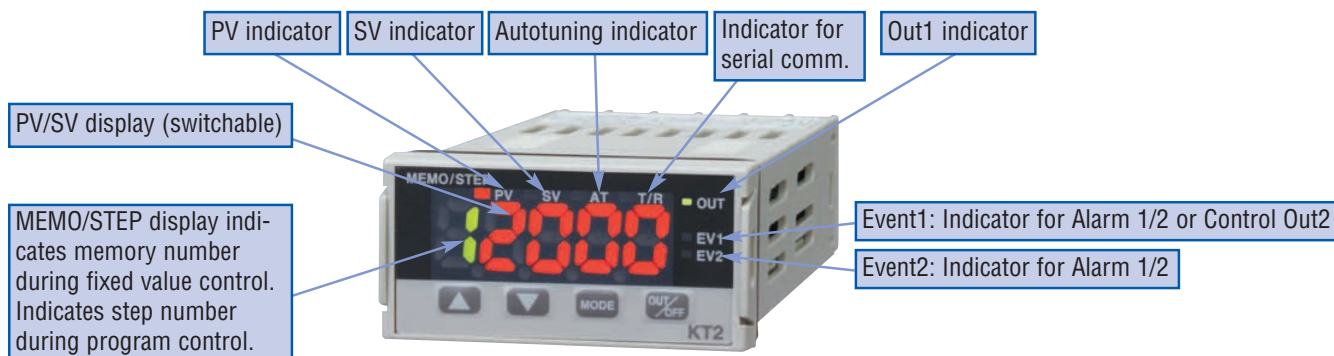

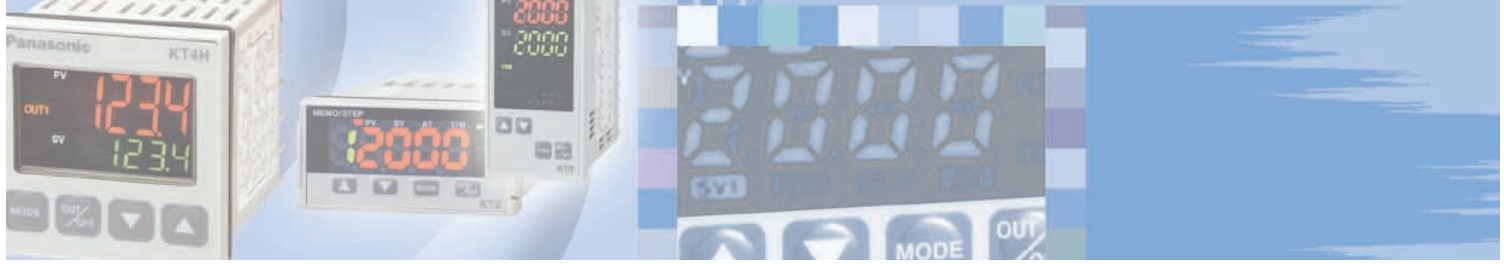

KT4H

Product Types

Temperature Controller KT4H

Space saving, high performance

- 1/16 DIN size temperature controller
- Size 48 x 48 x 56mm (WxHxD)
- Panel-mounted type
- IP66 waterproof (frontside if panel mounted)
- 2nd optional alarm output
- Heating and cooling control with 2nd optional control output (non-contact voltage output)
- 11-segment display with 3 colours for PV
- 4 set values (externally selectable)
- Tool Port as standard
- MEWTOCOL communication
- Heater burnout alarm supports 3-phase heaters



Ordering code

A K T 4 H 1 1 1 1 0 0 1

Power supply

1=100 to 240V AC
2=24V AC/DC

Sensor input

1=multi-input

Control output

1=relay
2=non-contact voltage
3=DC current

Alarm output

1=alarm1 relay
2=alarm1 and alarm2 relay

Communication function

blank=not available
1=RS485
2=contact input

Heater burnout alarm

0=not available
3=20A single phase
4=50A single phase
5=20A three phase
6=50A three phase

Heating/Cooling control output

0=no control output 2
1=relay
2=non-contact voltage

In stock:





AKT4H111100
AKT4H112100
AKT4H113100
AKT4H211100
AKT4H212100
AKT4H213100
AKT4H1111001
AKT4H2111001
other types on demand



KT4H

New Features of KT4H (in comparison with KT4)

Better readability

-  Time-proven display with negative LCD + LED backlight
-  11-segment LCD with improved readability
-  Largest display of PV in its class
-  PV indication in three different colour

1. With negative type LCD and backlight, values can be read even under direct sunlight. Also, the 11-segment LCD displays makes it easier to read alphanumeric characters

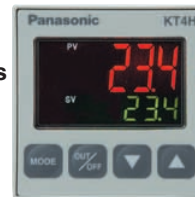





2. The letter height of PV value has been enlarged to 12mm enabling it to be directly read even from a distance.



3. The ability of the PV value to change color makes it easy to determine the process status at a glance (three colour available).



Improved control functions

-  Capable of 4-point temperature selection by external input.
-  Control output can be turned ON and OFF externally.
-  3-phase heater burn-out detection function.
-  Non-contact voltage output in heating/cooling control output available.

1. Four setting values (SV) selectable using external input (option).

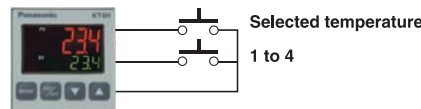

2. External ON and OFF switching of control output possible (option).

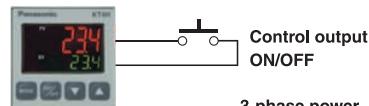

3. Heater burn-out alarm supports 3-phase heaters (option).

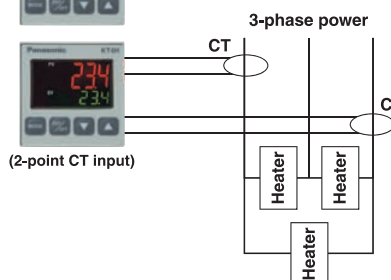

4. Supports voltage output for heating/cooling control (for SSR drive) (option).

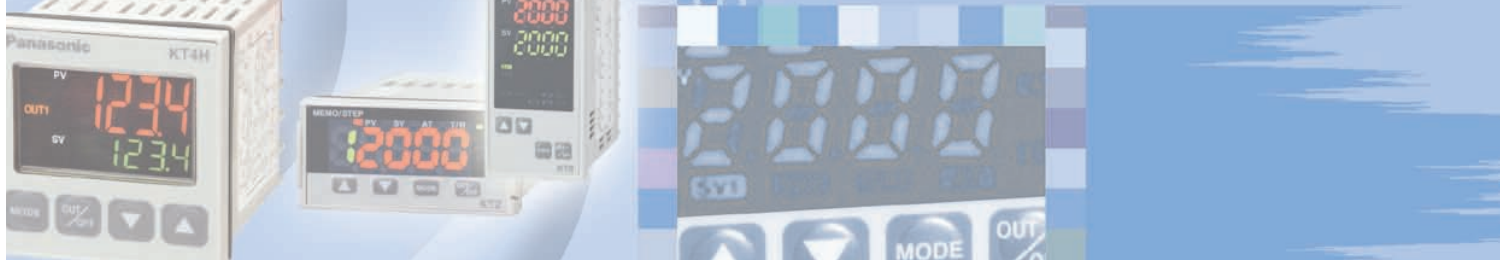

KT4H

New Features of KT4H (in comparison with KT4)

Improved communication functions

Connect several KT4H to FP-Series PLCs

- MEWTOCOL communications protocol is built in. Up to 31 units can be connected and data can be collected using a FPΣ(Sigma) PLC.

Comes with MEWTOCOL. Collect data with the PLC.

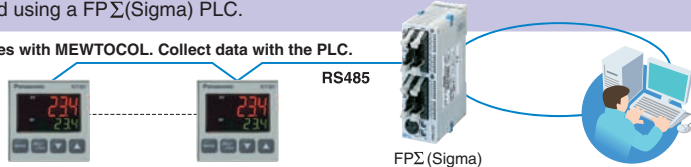

Standard external tool port

- With the external tool port, all settings can be loaded and made.

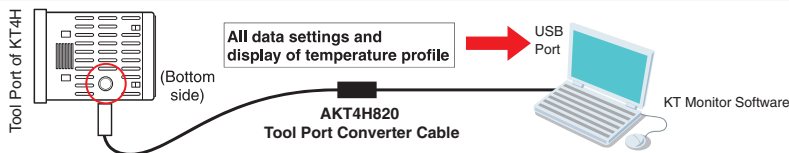

Space savings

- Control panel installation length has been shortened to the utmost.

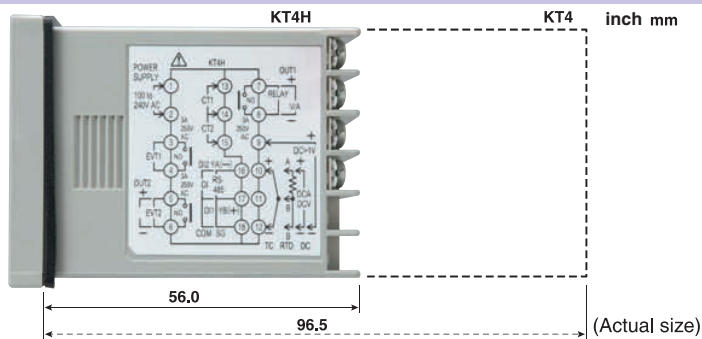

Ability to use any sensor (input) is inherited from KT Series

- The KT4H comes equipped with the ability to use any sensor (input): thermocouple (10 types), RTD (2 types), DC current (2 types), and DC voltage (4 types).

High accuracy and high sampling period also inherited from KT Series

- The operation mode uses "PID control" which allows a stable temperature to be maintained. Capable of high accuracy with an input span of $\pm 0.2\%$ and a high-speed sampling period of 250ms.

Easier operation

- The switch layout has been changed so that mode changes can be executed more easily using the front keys.
- Improved switch construction provides a much more positive clicking action.

Protective construction

- Despite its compact size, protective structure conforms to IP66 (front panel only, when using rubber packing).



KT4H

KT-Monitor Software

KT-Monitor is a convenient software tool for editing the parameters of KT4H, saving parameters in a file, monitoring of temperature data, and monitoring and saving log files of designated values.

KT-Monitor Main Window

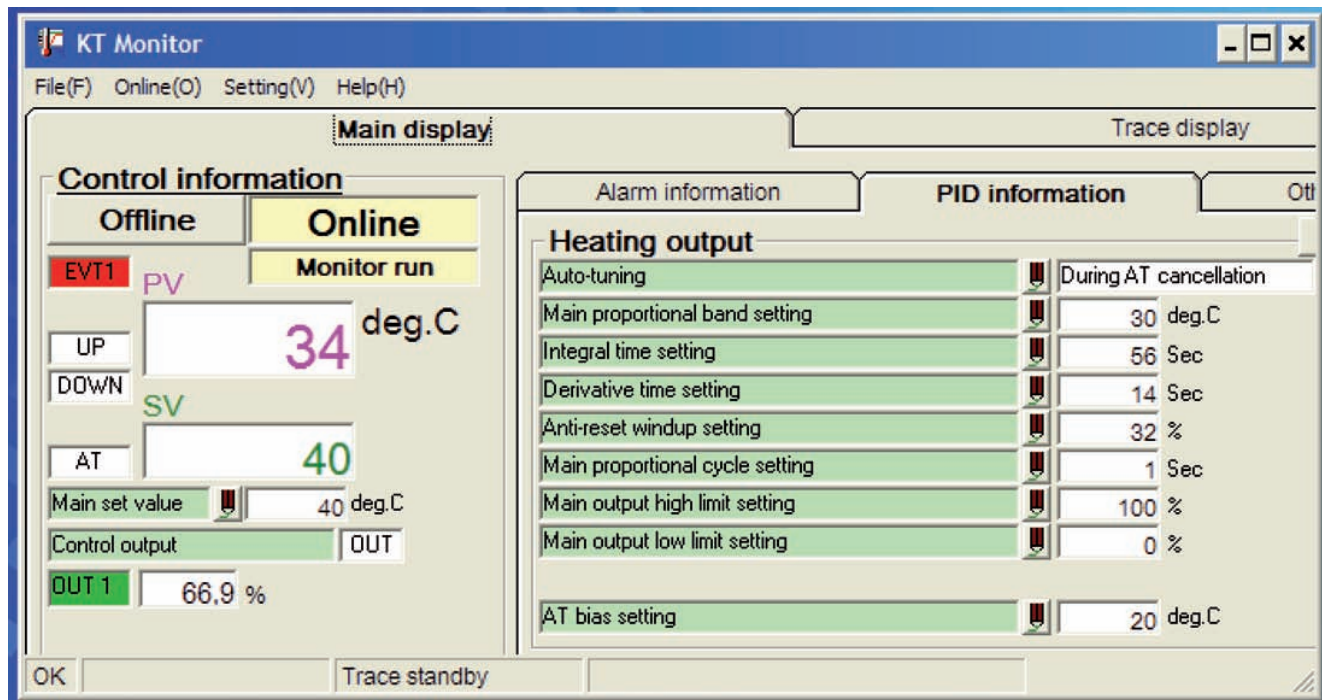

Parameters can easily be understood and are accessible in a clear, convenient form.



Ordering information: KT-Monitor Set
 CD with Software, Manuals, Tool Port cable AKT4H820

Requirements: PC with Windows 98/ME/2000 or XP, USB-Port, Tool cable AKT4H820, USB driver installed (included with KT-Monitor)

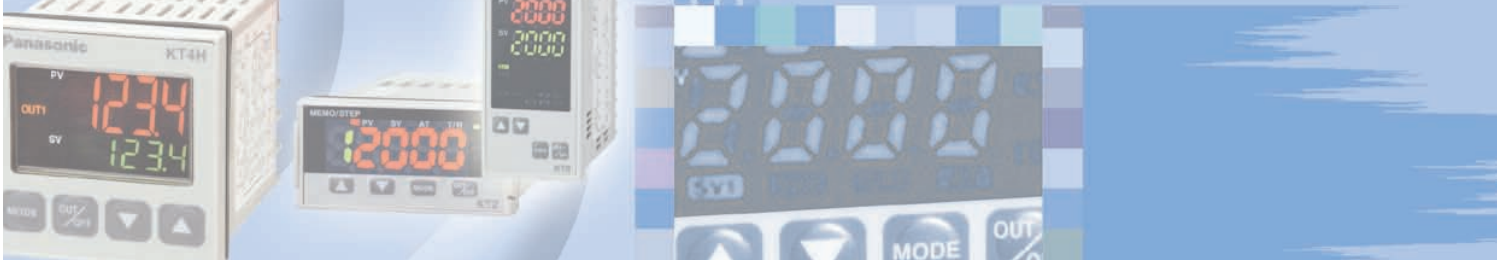

KT4H

KT-Monitor Software

Sampling and trend monitoring of PV, SV, MV1 and MV2

KT-Monitor Trace display

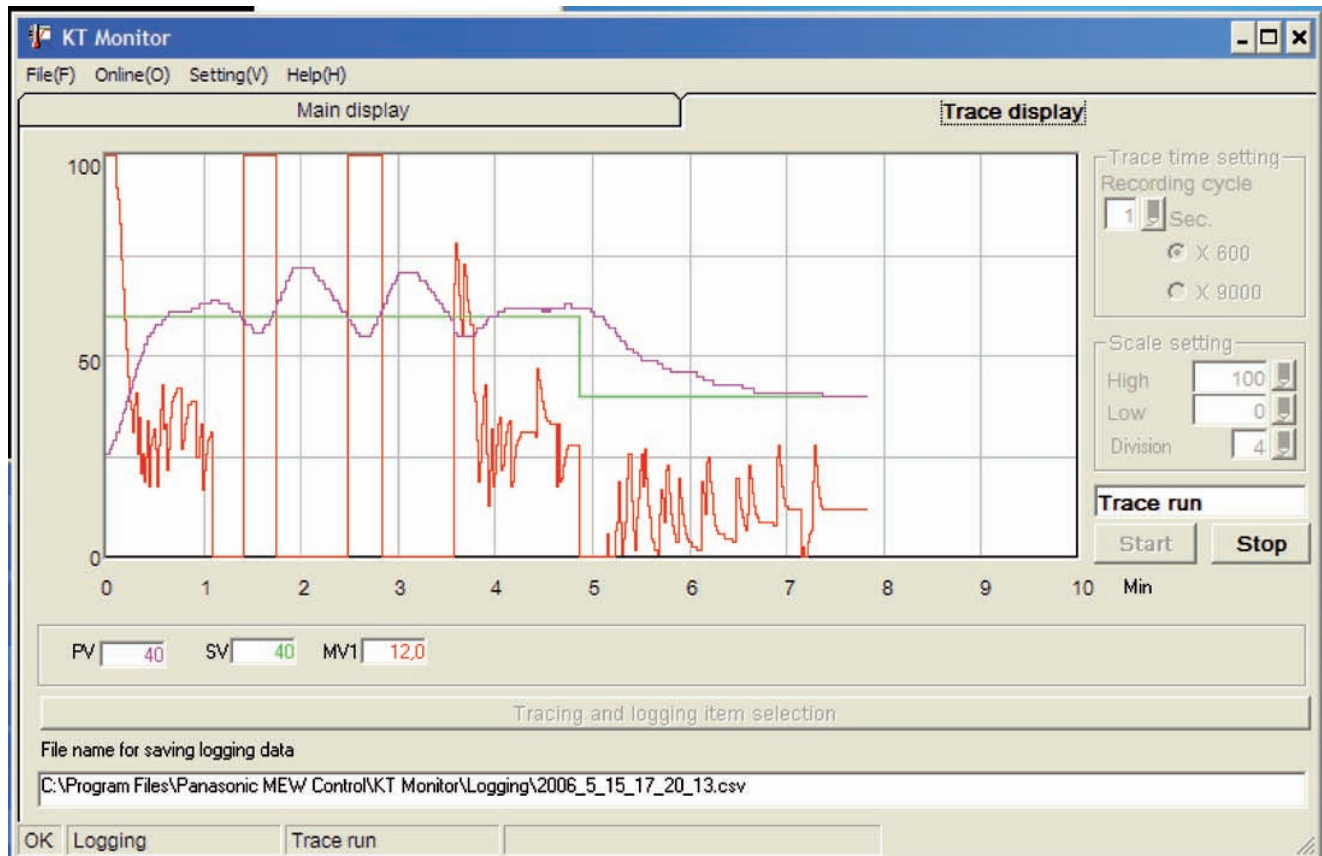

With the Trace display you can display and analyze the temperature PV, the set value SV and the control output MV. MV2 will be indicated only when Heating/Cooling control option is added. All values can also be recorded into a CSV-File for later rework with e.g. Excel.

The colours of the traces are selectable. The recording time interval is selectable (min. 1 sec.) and also the total number of records can be selected between 600 (10 min.) and 9000 (150 min.).

For scaling of the displayed values, high and low limit values can be entered.

KT2

Product Types

Temperature Controller KT2

Tiny size – pattern control

- 1/32 DIN size temperature controller
- Size 48 x 24 x 98.5mm (WxHxD)
- 9-step pattern control (ramp function)
- Panel-mounted type
- IP66 waterproof (front side if panel mounted)
- 2 set values possible (externally selectable)
- 2nd optional alarm output
- Heating and cooling control with 2nd optional control output (relay)
- Analogue value converter function



Ordering code

A K T 2 1 1 1 1 0 0 1

Power supply
1=100 to 240V AC
2=24V AC/DC

Sensor input
1=multi-input

In stock:
AKT2111200
AKT2112200
AKT2113200
AKT2211200
AKT2212200
AKT21111001
AKT22120101
AKT22121001
other types on demand

Control output
1=relay
2=non-contact voltage
3=DC current

Alarm output
0=no alarm output
1=1 alarm output*
2=2 alarm outputs, 1 relay,
1 open collector output

RS485 interface
blank=not available
1=available

Heater burnout alarm
0=not available

Heating/Cooling control output
0=no control output 2
1=relay 3A 250V AC

* Type depends on other options

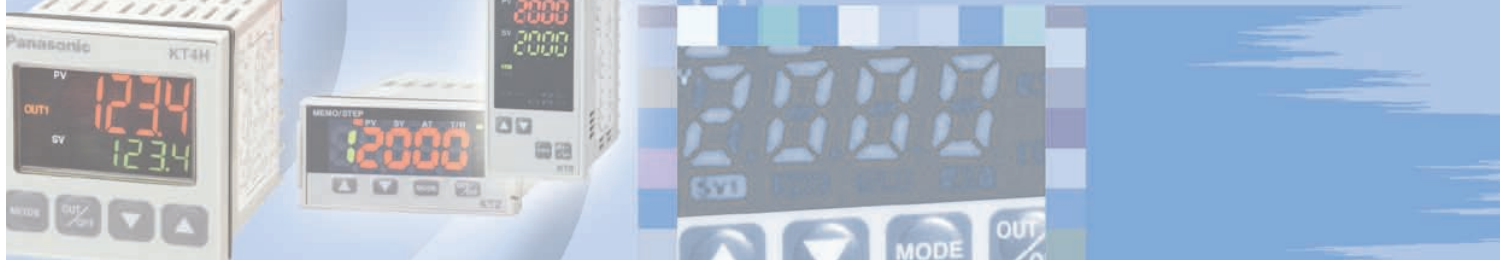

KT4

Product Types

Temperature Controller KT4

Small sized standard type

- 1/16 DIN size temperature controller
- Size 48 x 48 x 95mm (WxHxD)
- Panel-mounted type
- IP66 waterproof (frontside if panel mounted)
- 2nd optional alarm output
- Heating and cooling control with 2nd optional control output (non-contact voltage output)



Ordering code

A K T 4 1 1 1 1 0 0 1

Power supply
1=100 to 240V AC
2=24V AC/DC

Sensor input
1=multi-input

In stock:
AKT4111100
AKT4111200
AKT4112100
AKT4112140
AKT4113100
AKT4211100
AKT4211140
AKT4212100
AKT4212140
AKT41111001
AKT42111001
other types on demand

Control output
1=relay
2=non contact voltage
3=DC current

Alarm output
1=alarm 1 relay
2=alarm1 and alarm2
 relay

Communication function
blank=not available
1=RS485

Heater burnout alarm
0=not available
1=5A
2=10A
3=20A
4=50A

Heating/Cooling control output
0=no control output 2
4=SSR output 0.3A 250V AC



KT7

Product Types

Temperature Controller KT7 *Handy and slim*

- Size 22.5 x 75 x 100mm (WxHxD)
- Front screw terminals
- DIN rail mounting type
- Analogue value converter function



Ordering code

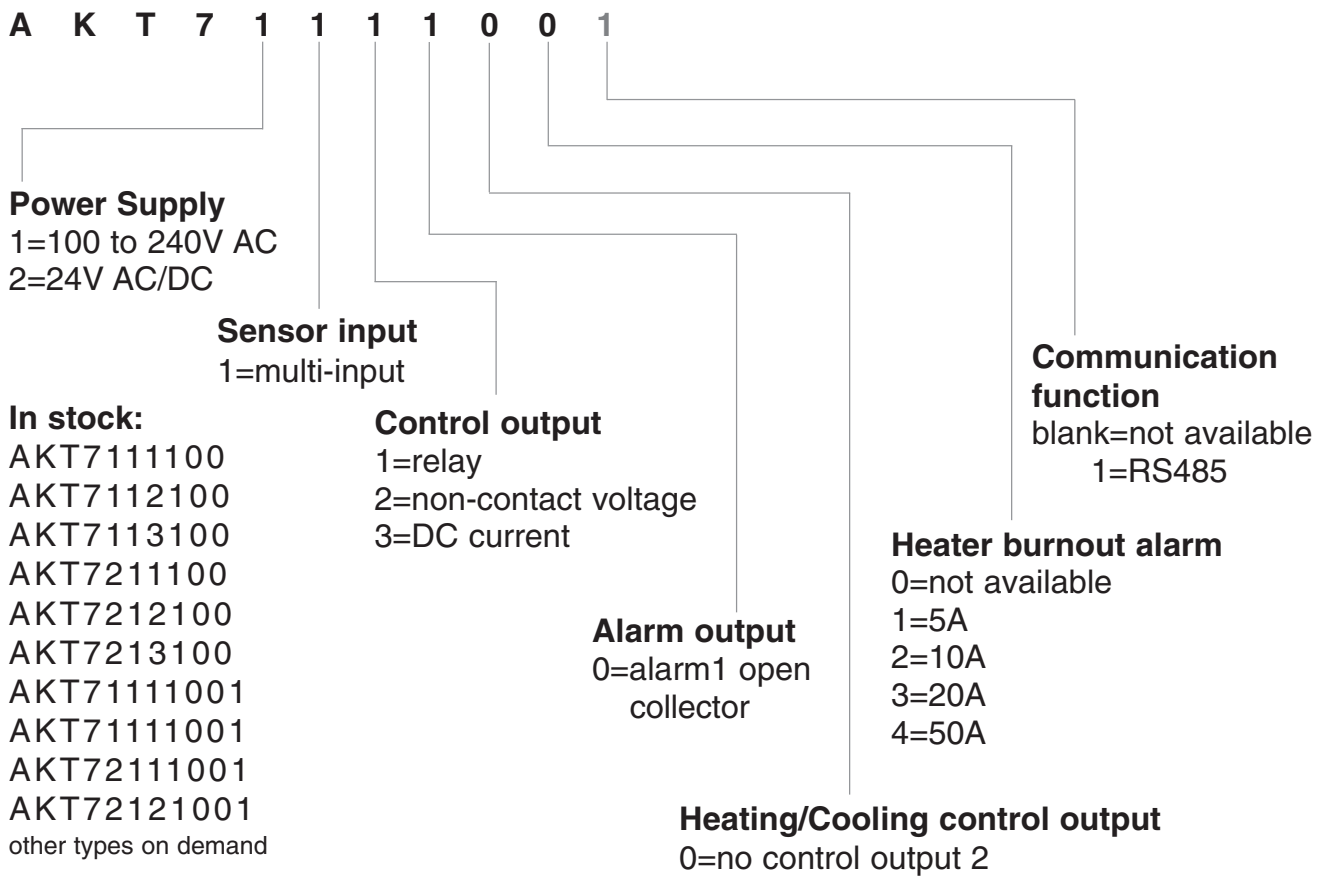

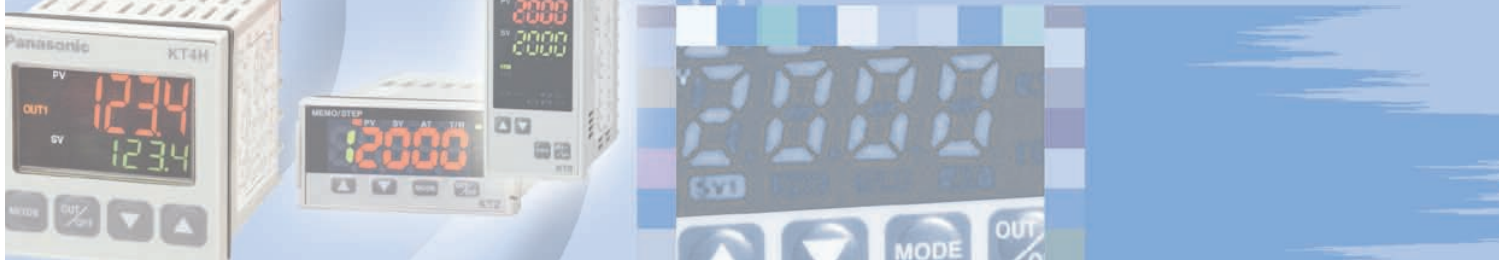

KT8

Product Types

Temperature Controller KT8

Wide variety of options, easily readable display

- 1/8 DIN size temperature controller
- Size 48 x 96 x 98.5mm (WxHxD)
- Panel-mounted type
- IP66 waterproof (front side if panel mounted)
- 2 set values possible (externally selectable)
- 2nd optional alarm output
- Heating and cooling control with 2nd optional control output (relay, non-contact voltage, or current)
- Ordering code



Ordering code

A K T 8 1 1 1 1 0 0 1

Power supply
1=100 to 240V AC
2=24V AC/DC

Sensor input
1=multi-input

In stock:
AKT8111100
AKT8112100
AKT8112200
AKT8212210
AKT81122001
AKT82122001
other types on demand

Control output
1=relay
2=non-contact voltage
3=DC current

Alarm output
0=alarm1 open collector
2=alarm1 and alarm2 relay

Communication function
blank=not available
1=RS485

Heater burnout alarm
0=not available
1=5A
2=10A
3=20A
4=50A

Heating/Cooling control output
0=no control output 2
1=relay
2=non-contact voltage
3=current output

KT9

Product Types

Temperature Controller KT9

Big display

- 1/4 DIN size temperature controller
- Size 96 x 96 x 98.5mm (WxHxD)
- Panel-mounted type
- IP66 waterproof (front side if panel mounted)
- 2 set values possible (externally selectable)
- 2nd optional alarm output
- Heating and cooling control with 2nd optional control output (relay, non-contact voltage, or current)
- Ordering code



Ordering code

A K T 9 1 1 1 1 0 0 1

Power supply
1=100 to 240V AC
2=24V AC/DC

Sensor input
1=multi-input

In stock:
AKT9111100
AKT9111110
AKT9112100
AKT9113230
AKT9212100
AKT9212120
AKT91111001
AKT92111001
other types on demand

Control output
1=relay
2=non-contact voltage
3=DC current

Alarm output
1=alarm1 open collector
2=alarm1 and alarm2 relay

Communication function
blank=not available
1=RS485

Heater burnout alarm
0=not available
1=5A
2=10A
3=20A
4=50A

Heating/Cooling control output
0=no control output 2
1=relay
2=non-contact voltage
3=current output

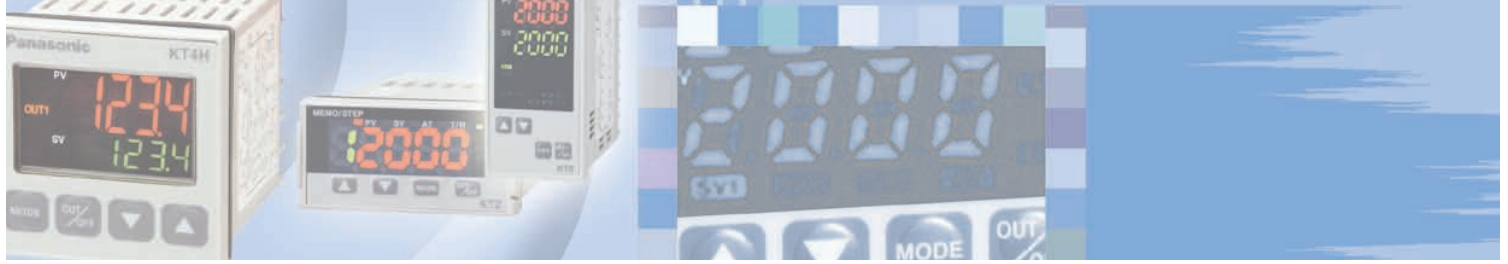

KT Series

Ratings and Specifications

Display		Specifications					
		KT2	KT4	KT4H	KT8	KT9	KT7
Size (W x H x D)		48 x 24 x 98.5mm	48 x 48 x 95mm	48 x 48 x 56mm	48 x 96 x 98.5mm	96 x 96 x 98.5mm	22.5 x 75 x 100mm
Supply voltage (must be specified)		100 to 240V AC					
Frequency		24V AC/DC					
Power consumption		50/60Hz					
Input type		Approx. 5VA					
Input range		Approx. 5VA					
Thermocouple	K	-200 to 1370°C					
	J	-199.9 to 400.0°C					
	R	-200 to 1000°C					
	S	0 to 1760°C					
	B	0 to 1760°C					
	E	0 to 1820°C					
	T	-200 to 800°C					
	N	-199.9 to 400.0°C	-200.0 to 400.0°C		-199.9 to 400.0°C		
	PL-II	-200 to 1300°C					
RTD	C (W/Re5-26)	0 to 2315°C					
	Pt100	-200 to 850°C					
	JPH100 3-conductor system	-199.9 to 850.0°C	-200 to 850.0°C		-199.9 to 850.0°C		
DC Current	4 to 20mA DC ¹⁾	-200 to 500°C					
	0 to 20mA DC ¹⁾	-199.9 to 500.0°C					
DC Voltage	0 to 1V DC ²⁾	-1999 to 9999, -199.9 to 999.9		-2000 to 10000		-1999 to 9999, -199.9 to 999.9	
	0 to 10V DC ³⁾	-19.99 to 99.99, -1.999 to 9.999				-19.99 to 99.99, -1.999 to 9.999	
	1 to 5V DC ³⁾						
	0 to 5V DC ³⁾						
		<ul style="list-style-type: none"> Scale and change to the decimal point place for DC current and DC voltage. DC current input support than externally mounted 50 Ω shunt resistor (select option). 					
Control output	Relay contact	(Must be specified)	1a	1a	1a	1a1b	1a1b
	Non-contact DC voltage		3A 250V AC (Resistive load), 1A 250V AC (Inductive load cosφ=0.4), electric life: 100,000 times				
	DC current		12 V _{DC} 14V DC; max. current: 40mA (Short-circuit protected)				
Alarm output1			4 to 20mA load resistance: $\times 150 \Omega$				
Control mode			Relay contact: 3A 250V AC (Resistive load) Electric life: 100,000 times				Open detector, Contact capacity: 24V DC 0.1A (Max)
Accuracy			Actions mentioned below can be selected by key operation. [Default PID] PI D (with auto-tuning function), PI, PD (with manual reset function), P (with manual reset function), ON/OFF action Thermocouple: Within ±0.2% of each input span ±1 digit or within ±2°C whichever is greater. However, R and S input; within ±6°C in the range of 0 to 200°C B input 0 to 300°C: Accuracy is not guaranteed. K, J, E and N input less than 0°C: Within ±0.4% of input span ±1 digit RTD: Within ±0.1% of each input span ±1 digit or ±1°C whichever is greater DC current and DC voltage: Within ±0.2% of each input span ±1 digit				
Sampling period			250ms				
Hysteresis			Thermocouple & RTD: 0.1 to 100.0°C DC current and DC voltage: 1 to 1000 (The decimal point place follows the section)				
Proportional band			Thermocouple: 0 to 1000°C RTD: 0.0 to 999.9°C DC current and DC voltage: 0.0 to 100.0%				0.0 to 110.0%
Integral time			0 to 1000 seconds				
Derivative time			0 to 300 seconds				
Proportional cycle			1 to 120 seconds				
Allowable voltage fluctuation			When 100 to 240V AC; 85 to 264V AC When 24V AC/DC; 20 to 28V AC/DC				
Insulated resistance			500V DC 10MΩ or greater				
Breakdown voltage	1.5kV AC for 1 min between input terminal and power terminal & between output terminal and power terminal	See KT8/KT9	1.5kV AC for 1 min between input terminal and power terminal & between output terminal and power terminal	1.5kV AC for 1 min between input terminal and ground terminal between input terminal and power terminal between power terminal and ground terminal between output terminal and ground terminal, & between output terminal and power terminal	1.5kV AC for 1 min between input terminal and power terminal & between output terminal and power terminal	1.5kV AC for 1 min between input terminal and power terminal & between output terminal and power terminal	
Malfunction vibration			10 to 55Hz (0.35mm) to each direction (120msec prep) for 10min.				



KT Series

Ratings and Specifications

Display		Specifications					
		KT2	KT4	KT4H	KT8	KT9	KT7
Breakdown vibration		10 to 55Hz (0.75mm) to each direction (120ms sweep) for 10min.					
Malfunction shock		X, Y & Z each direction for 5 times 10G					
Breakdown shock		Same as above, but 30G					
Ambient temperature		0 to 50°C					
Ambient humidity		35 to 85%RH (No condensation)					
Mass		Approx. 120g	Approx. 130g	Approx. 120g	Approx. 240g	Approx. 370g	Approx. 150g
Waterproof		IP66 (applicable only to the front panel subject to rubber gasket employed)					None
Display character height		PV: 8.7mm SV: 8.7mm*	PV: 10.2mm SV: 8.8mm	PV: 12mm SV: 6mm	PV: 11.2mm SV: 11.2mm	PV: 18mm SV: 13.2 mm	PV: 7.4mm SV: 7.4mm
	Alarm output 2	0.1A 24V DC	The same as the one of Alarm output 1				None
Options	Heating/Cooling control	Relay contact: 1a 3A 250V DC (Resistive load)	Non contact relay 0.3A 250V AC (Resistive load)	<ul style="list-style-type: none"> Relay contact 1a: 3A 250V AC (Resistive load) Electric life: 100,000 times Non contact voltage: 12V DC \pm15% max. 40mA (Short circuit protected) 	<ul style="list-style-type: none"> Relay contact: 1a 250VAC 3A (Resistive load), 250V AC 1A (Inductive load $\cos\phi=0.4$), Electric life: 100,000 times Non-contact voltage: 12 – 14V DC max. 40mA (Short-circuit protected) DC current: 4 to 20mA DC Load resistance: Max. 550 		None
	Heater burn-out alarm	Heater rated current must be selected from 5A, 10A, 20A and 50A Setting accuracy: Within 5% of heater rated current					
	Output	None	Relay contact 1a 250V AC 3A (Resistive load), Electric life: 100,000 times				Open collector, Control capacity: 24VDC 0.1A (Max)
	Communication function	RS485 interface for multidrop communication (details see below)					
	Tool Port	None	None	Communication interface C-MOS level, cannot be used at the same time as serial communication (option). This port can only be used with the tool cable (AKT4H820).	None		

*PV/SV switching display

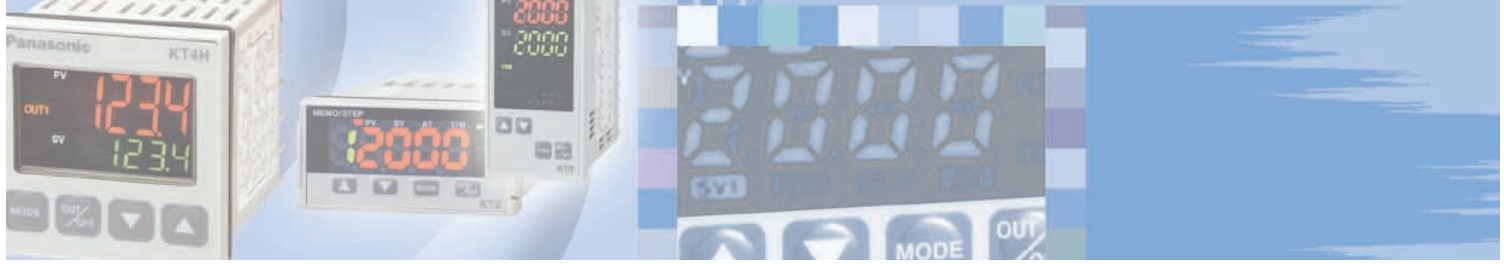

KT Series

Communication Function Overview

Communication via RS485 and Modbus (ASCII) or Modbus RTU protocol

Example 1
Multidrop communication with a programmable logical controller (PLC)

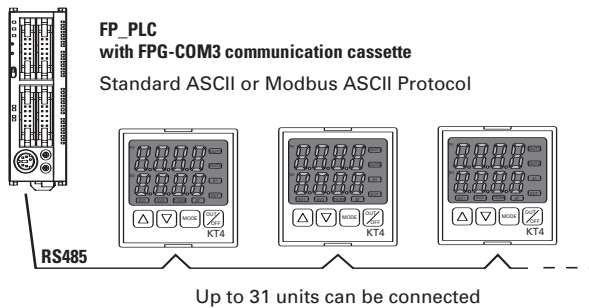

Example 2
Multidrop communication with a personal computer

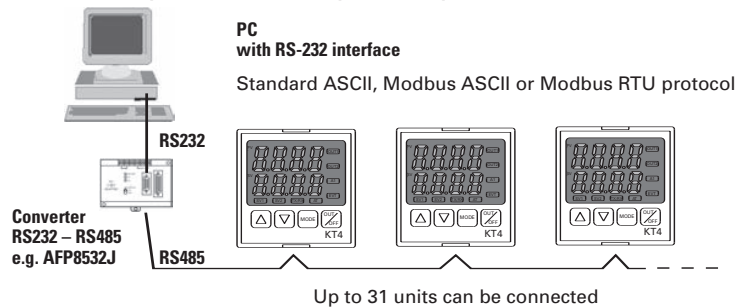

With the optional communication function all settings can be entered or changed.
Input value (PV) and other parameters can be read easily.
All commands are described in the KTC1E1 manual.

Communication via MEWTOCOL (slave) with any FP-Series PLC*

Item	Specification
Communication type	Half-duplex
Communication speed	Select 2400, 4800, 9600, or 19200 bps using key operation.
Synchronization type	Asynchronous
Protocols	Standard protocol (ASCII), Modbus (ASCII) or Modbus RTU mode (8-bit binary coding), KT4H also MEWTOCOL (Slave)
Coding	ASCII/binary
Error correcting	Command re-send
Error detection	Parity check, CRC-16 (RTU), LRC (ASCII)
Data structure	Start bit: 1 Data bit: 7 (ASCII), 8 (RTU) Parity: Even, No, Odd (Selectable), KT2: Even (ASCII), None (RTU) Stop bit: 1/2
Interface	RS485 compliant
No. of nodes	31
Maximum cable length	1,000 m (cable resistance must be within 50Ω)

Note) That main setting no. 2 is not possible on the KT8 and KT9 when the communications functions are added.

* Only for KT4H

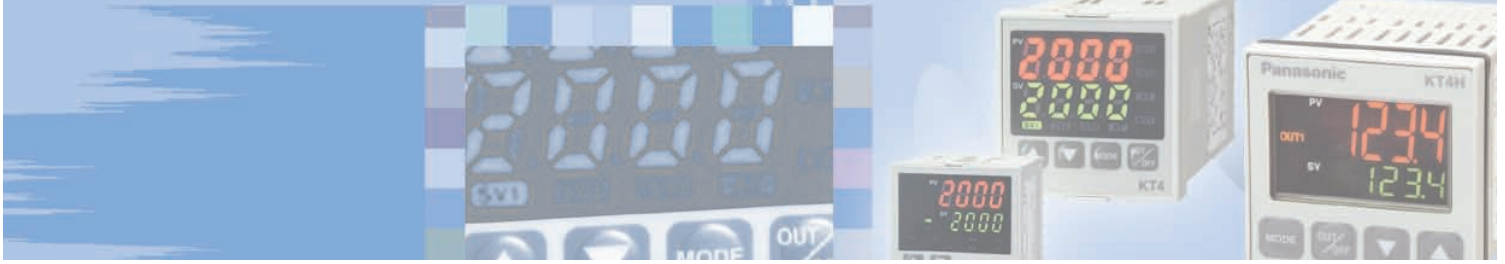

KT2

Dimensions

KT2 Series (unit: mm)

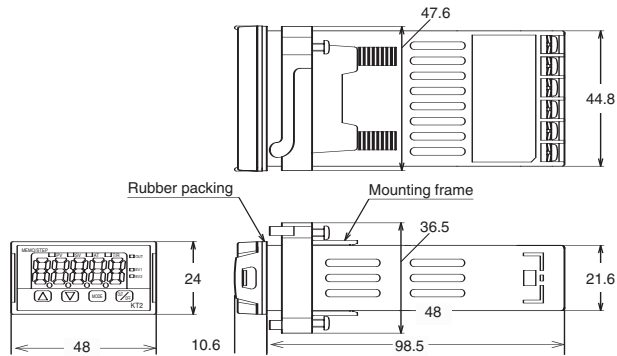

• Panel cutout

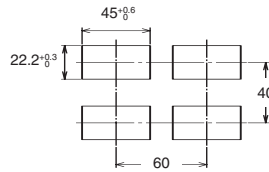

KT4 Series (unit: mm)

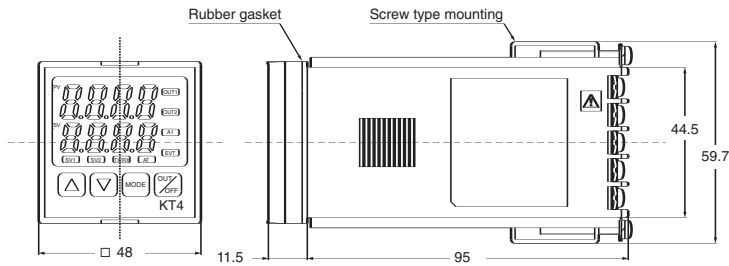

• Panel cutout

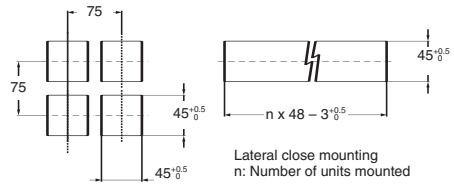

Note) The communications terminal is the screw terminal on the back of the unit.

KT4H Series (unit: mm)

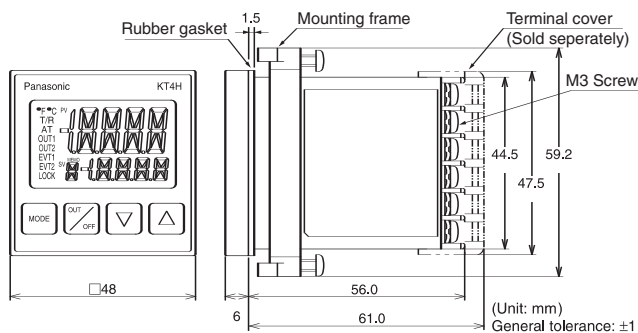

• Panel cutout

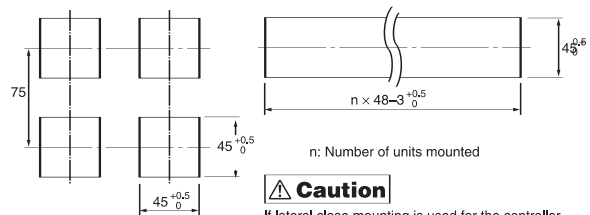

Caution

If lateral close mounting is used for the controller, IP66 specification (Dust-proof/Drip-proof) may be compromised, and all warranties will be invalidated.

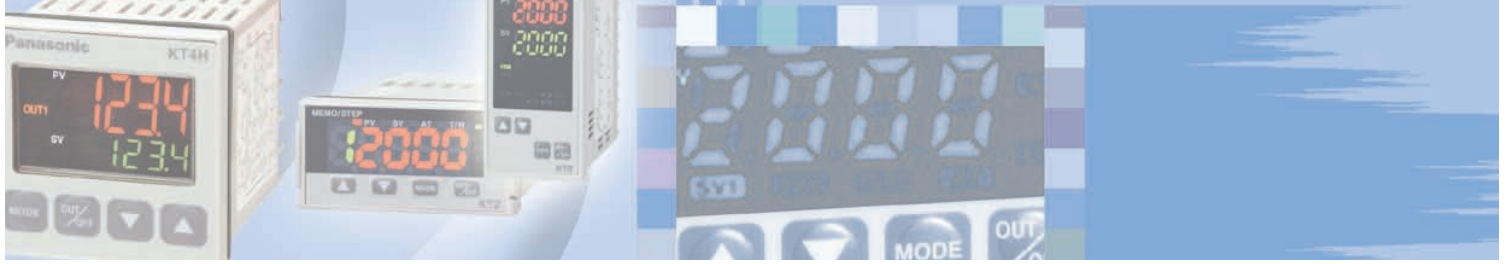

KT Series

Dimensions

KT8 Series (unit: mm)

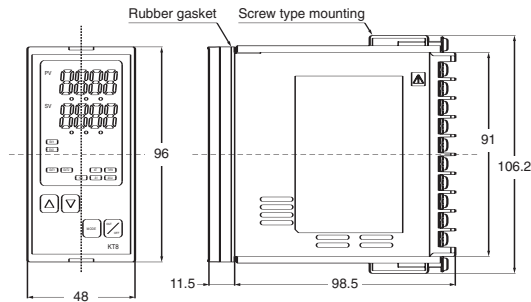

• Panel cutout

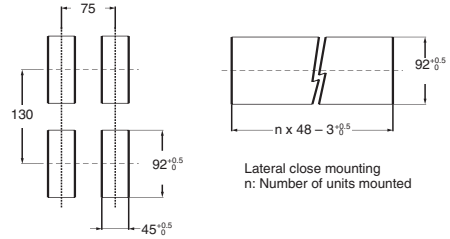

Note) The communications terminal is the screw terminal on the back of the unit.

KT9 Series (unit: mm)

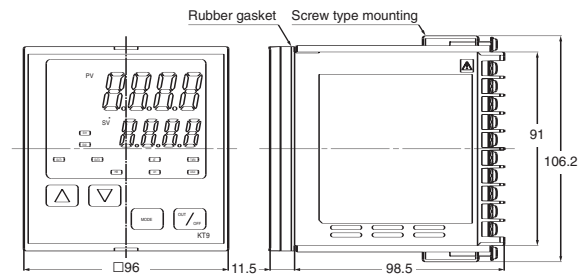

• Panel cutout

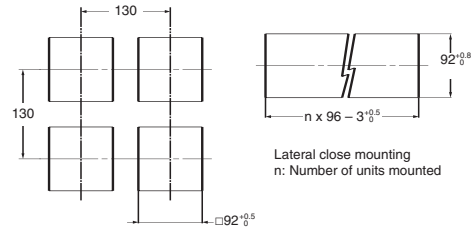

Note) The communications terminal is the screw terminal on the back of the unit.

KT7 Series (unit: mm)

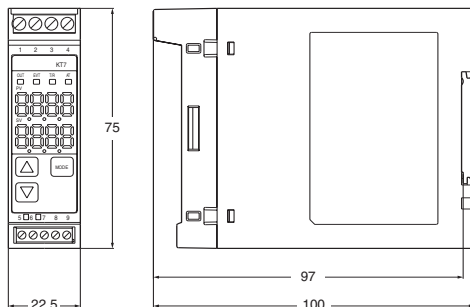

Note) The communications terminal is the modular jack on the bottom of the unit.

DIN rail mounting

Recommended DIN rail: Part No. AT8DLA1

Recommended fastening plate: Part No. ATA4806

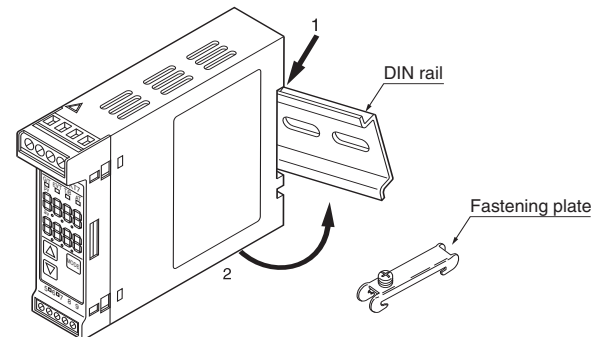

Note) The communications terminal is the modular jack on the bottom of the unit.

KT Series

Accessories

Shunt resistor for current input (mA)
AKT4810 for KT2, KT4, KT4H, KT8, KT9



AKT4811 for KT7

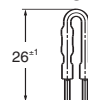

all units on this page in mm

Terminal cover to protect rear side screw terminals from contact
AKT4801 for KT4

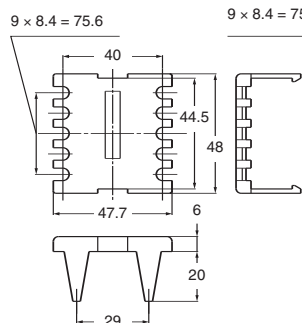

AKT8801 for KT8
AKT9801 for KT9

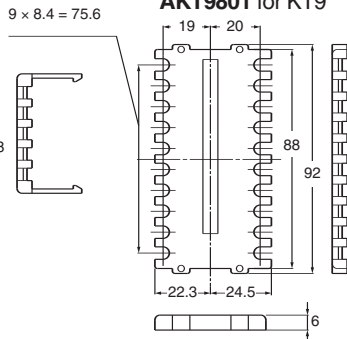

AKT4H801 for KT4H

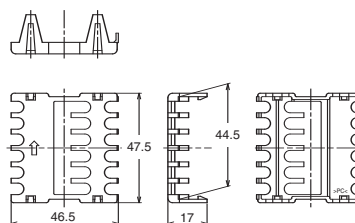

AKT2801 for KT2

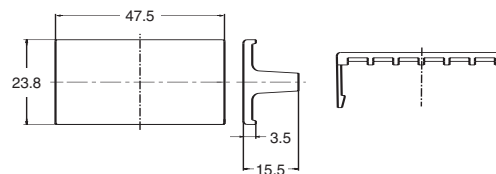

Current Transformer

CT1 or CT2 for current detection is provided as an accessory for all types with heater burnout alarm function. They are enclosed for these types and need not be ordered separately.

CT1 (for 20A)

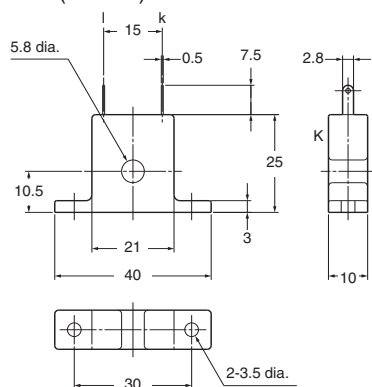

CT2 (for 50A)

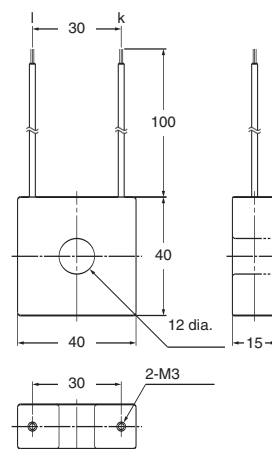

Tool cable to connect the KT4H's tool port to a PC's USB port.
AKT4H820

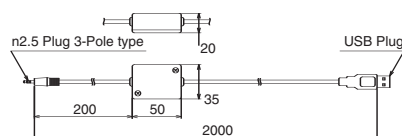



Global Network Services

North America

Europe

Asia Pacific

China

Japan

Panasonic Electric Works

Please contact our Global Sales Companies in:

Europe

▶ Headquarters	Panasonic Electric Works Europe AG	Rudolf-Diesel-Ring 2, 83607 Holzkirchen, Tel. (08024) 648-0, Fax (08024) 648-111, www.panasonic-electric-works.com
▶ Austria	Panasonic Electric Works Austria GmbH	Josef Madersperger Str. 2, 2362 Biedermannsdorf, Tel. (02236) 26846, Fax (02236) 46133, www.panasonic-electric-works.at
	PEW Electronic Materials Europe GmbH	Ennsstafelstraße 30, 4470 Enns, Tel. (07223) 883, Fax (07223) 88333, www.panasonic-electronic-materials.com
▶ Benelux	Panasonic Electric Works	
	Sales Western Europe B.V.	De Rijn 4, (Postbus 211), 5684 PJ Best, (5680 AE Best), Netherlands, Tel. (0499) 372727, Fax (0499) 372185, www.panasonic-electric-works.nl
▶ Czech Republic	Panasonic Electric Works Czech s.r.o.	Prumyslová 1, 34815 Planá, Tel. 374 799 990, Fax 374 799 999, www.panasonic-electric-works.cz
▶ France	Panasonic Electric Works	
	Sales Western Europe B.V.	
	PEW Electronic Materials France S.A.R.L.	French Branch Office, B.P. 44, 91371 Verrières le Buisson CEDEX, Tél. 01 60135757, Fax 01 60135758, www.panasonic-electric-works.fr
▶ Germany	Panasonic Electric Works Deutschland GmbH	26 Allée du Clos des Charmes, 77090 Collégien, Tél. 01 64622919, Fax 01 64622809, www.panasonic-electronic-materials.com
▶ Ireland	Panasonic Electric Works UK Ltd.	Rudolf-Diesel-Ring 2, 83607 Holzkirchen, Tel. (08024) 648-0, Fax (08024) 648-555, www.panasonic-electric-works.de
▶ Italy	Panasonic Electric Works Italia s.r.l.	Dublin, Tel. (01) 4600969, Fax (01) 4601131, www.panasonic-electric-works.co.uk
	PEW Building Materials Europe s.r.l.	Via del Commercio 3-5 (Z.I. Ferlina), 37012 Bussolengo (VR), Tel. (045) 6752711, Fax (045) 6700444, www.panasonic-electric-works.it
▶ Nordic Countries	Panasonic Electric Works Nordic AB	
	PEW Fire & Security Technology Europe AB	Viale Elvezia 18, 20154 Milano (MI), Tel. (02) 33604525, Fax (02) 33605053, www.panasonic-building-materials.com
▶ Portugal	Panasonic Electric Works España S.A.	Sjöängsvägen 10, 19272 Sollentuna, Sweden, Tel. (08) 59476680, Fax (08) 59476690, www.panasonic-electric-works.se
▶ Spain	Panasonic Electric Works España S.A.	Citadellsvägen 23, 21118 Malmö, Tel. (040) 6977000, Fax (040) 6977099, www.panasonic-fire-security.com
▶ Switzerland	Panasonic Electric Works Schweiz AG	Portuguese Branch Office, Avda Adelino Amaro da Costa 728 R/C J, 2750-277 Cascais, Tel. (21) 4812520, Fax (21) 4812529
▶ United Kingdom	Panasonic Electric Works UK Ltd.	Barajas Park, San Severo 20, 28042 Madrid, Tel. (91) 3293875, Fax (91) 3292976, www.panasonic-electric-works.es
		Grundstrasse 8, 6343 Rotkreuz, Tel. (041) 7997050, Fax (041) 7997055, www.panasonic-electric-works.ch
		Sunrise Parkway, Linford Wood, Milton Keynes, MK14 6LF, Tel. (01908) 231555, Fax (01908) 231599, www.panasonic-electric-works.co.uk

North & South America

▶ USA	PEW Corporation of America	629 Central Avenue, New Providence, N.J. 07974, Tel. 1-908-464-3550, Fax 1-908-464-8513, www.pewa.panasonic.com
	Head Office USA	

Asia Pacific / China / Japan

▶ China	Panasonic Electric Works (China) Co., Ltd.	2013, Beijing Fortune, Building No. 5, Dong San Huan Bei Lu, Chaoyang District, Beijing, Tel. (010) 6590-8646, Fax (010) 6590-8647
▶ Hong Kong	Panasonic Electric Works	Rm1601, 16/F, Tower 2, The Gateway, 25 Canton Road, Tsimshatsui, Kowloon, Hong Kong, Tel. (0852) 2956-3118, Fax (0852) 2956-0398
	(Hong Kong) Co., Ltd.	
▶ Japan	Matsushita Electric Works, Ltd.	1048 Kadoma, Kadoma-shi, Osaka 571-8686, Japan, Tel. (06) 6908-1050, Fax (06) 6908-5781, www.mew.co.jp/e-acg/
▶ Singapore	Panasonic Electric Works Asia Pacific Pte. Ltd.	101 Thomson Road, #25-03/05, United Square, Singapore 307591, Tel. (06255) 5473, Fax (06253) 5689

Panasonic[®]

Copyright © 2006 • Printed in Germany
6205 euen 06/06