

# Programmable Logic Controllers



Selection Guide.....	2
MicroSmart Family.....	3
<b>NEW</b> MicroSmart Pentra CPU Part Numbers.....	7
MicroSmart CPU Part Numbers .....	8
Expansion Modules.....	10
Programming Software - WindLDR .....	23
Specifications & Dimensions .....	24
OpenNet Controller .....	45
IEDEC SmartRelay .....	56
Selection Guide.....	58
Programming Software - WindLGC .....	60
Specifications & Dimensions .....	61



For more information on this product family, visit our website.

Additional resources include:

- New and updated product information
- Downloadable software demos & upgrades
- Part configuration tool & cross reference
- Online stock check & ordering
- IDEC field sales & distributor search
- Online literature request
- Downloadable manuals & CAD drawings
- Manufacturer's suggested retail price list
- Product training schedule & locations
- Advertising & trade show schedules
- Press releases & FAQs

[www.idec.com/plc](http://www.idec.com/plc)

## Selection Guide

### Programmable Logic Controllers

PLCs









Operator Interfaces

Automation Software

Power Supplies

Sensors

Communication & Networking

	MicroSmart Family		OpenNet Controller (ONC)	SmartRelay	
	MicroSmart Pentra	MicroSmart			
Page	3	8	45	56	
Appearance					
Rated Voltage	24V DC, 100-240V AC	24V DC, 100-240V AC	24V DC	12-24V DC, 24V AC/DC, 100-240V AC/DC	
Max. Digital I/O	512	264	480	50	
Max. Analog I/O	56	56	42	10	
Program Capacity	62.4K bytes	31.2K bytes	32K bytes	2K bytes	
Max. Communication Ports	7	2	3	1	
Networking	Modbus RTU/ASCII	Yes	-	-	
	Modbus TCP	Yes	-	-	
	AS-Interface	Yes	Yes	-	Yes
	LONWORKS	-	-	-	Yes
32-bit Data	Yes	-	Yes	-	
Floating Point Math	Yes	-	-	-	
High-Speed I/O Freq.	100KHz	20KHz	10KHz	2KHz	
Approvals					

## MicroSmart Pentra



Micro-controllers play an increasingly central role in today's industrial applications. You have many controllers to choose from, but the one you turn to most often is the one that fits best, physically and practically. You'll find IDEC PLCs in various applications from water treatment plants to HVAC to printing press operations and more. They're always dependable, easy to program and almost as smart as you are.

IDEC brought some of the first micro-PLCs to the market, and has been meeting your changing control automation needs for decades. Now with the MicroSmart Pentra, you get the fastest and most full featured programmable logic controller there is.



### International Approvals

All MicroSmart controllers have regulatory agency certifications for the worldwide market including being cULus Listed for Class1 Division 2 Hazardous Locations, TUV approved, CE, and certified for marine use by ABS and Lloyd's Registry.

### Write & Run Your Programs Now

Relax. Programming the MicroSmart is fast and straightforward. Use IDEC's WindLDR software to configure, modify and monitor your MicroSmart programs with ease. This powerful and intuitive software makes it simple to get your system up and running.

### Rugged, Compact, Modular Design

Every CPU module comes equipped with embedded I/O points, and you can conveniently add snap-on expansion modules for up to 512 I/Os based on your system requirements. All MicroSmart controllers are DIN-rail or panel mountable.

### Upgrade Without Downtime

For added convenience, the same expansion I/O modules and accessories can be used on both the MicroSmart and MicroSmart Pentra controllers. In fact, both controllers share the same architecture, instruction set and programming software. The use of a single software platform for all IDEC PLCs means you won't have to reprogram or learn a new system to move from one to another.



### MicroSmart Pentra Performance

#### The Fastest Micro Controller in its Class!

MicroSmart Pentra is the fastest micro controller available in its class. The overall processing speed of the new Logic Engine CPU is 16 times faster than our competitor's average controller.

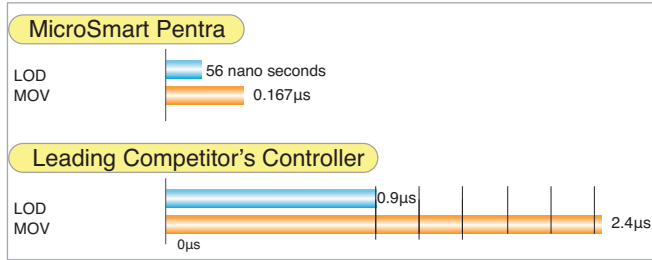

#### Supports 32-bit data and floating point math

MicroSmart Pentra supports double-word, floating point math operations, capturing and storing large values, and returning computed results accurate to seven decimal places.

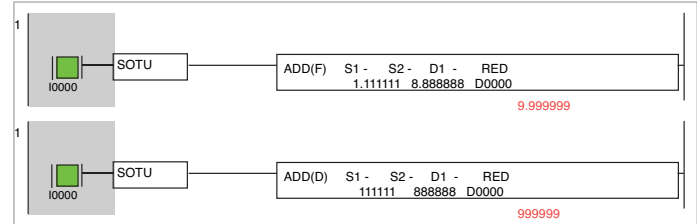

#### Field Upgradeable Firmware

Extend the life of your PLC! Upgrade your firmware on-site as new functions and versions become available.



#### Built-in Modbus RTU/ASCII master & slave, and Modbus TCP (1:1) de-facto protocol

Modbus messaging protocol is a de-facto protocol in industrial networking. Communication with other devices on a Modbus network can be easily achieved with built-in Macros instructions.

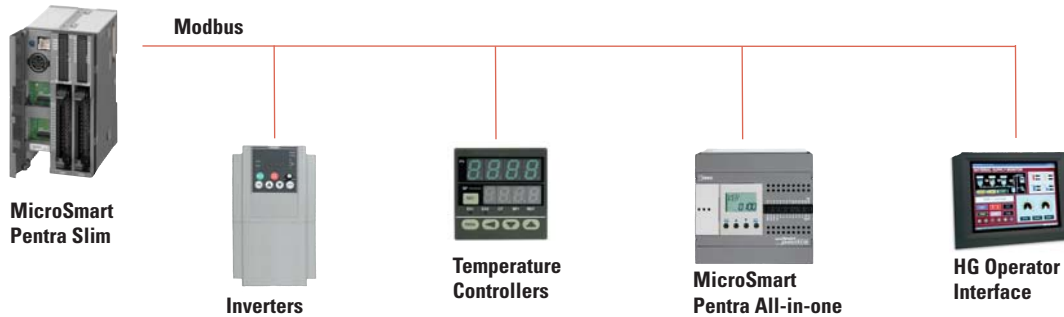

PLCs

Operator Interfaces

Automation Software

Power Supplies

Sensors

Communication & Networking

### MicroSmart Pentra Performance

#### Maximum 7 Communication Ports

MicroSmart Pentra models can accommodate up to a total of seven communication ports. Now you can connect your HMI, PC, barcode reader, RFID equipment, printer and more.



#### Integrated 100KHz Fast Inputs and Outputs

Configure up to four high-speed inputs from high-speed output devices such as rotary encoders or proximity switches at a maximum frequency of 100KHz, independent of the scan time. Up to three high-speed outputs can be used for simple positioning controls for stepper or servo motors.

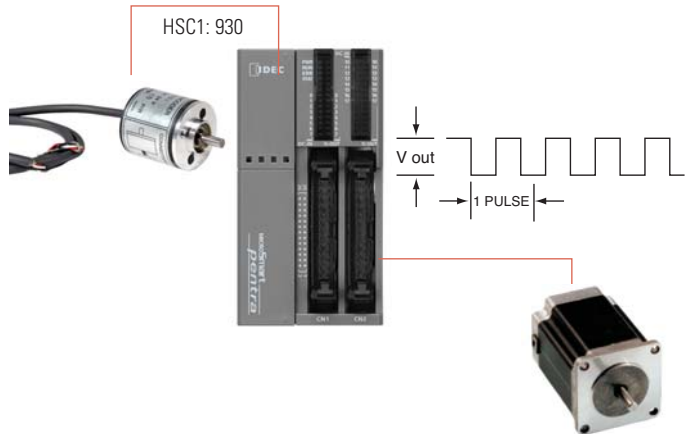

#### 56 PID Loops

PID is the standard solution to many industrial process controls because of its accuracy and stability. With up to 56 PID loops and advanced auto-tuning features, your systems can be tuned to optimum values for the desired control response.

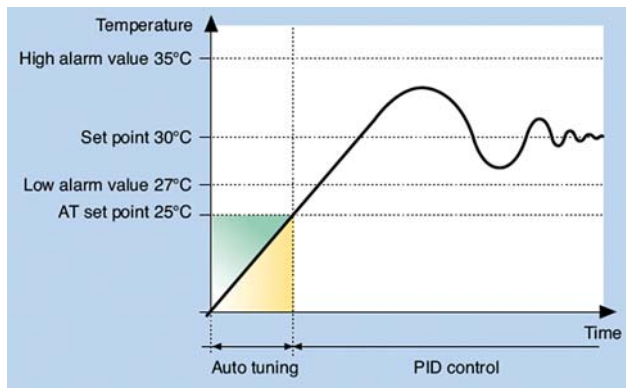

#### Maximum 56 Analog I/O

Your options include 0-10V, 4-20mA, RTD, thermocouple, thermistor inputs and +/-10V output. With built-in Macro instructions, configuring analog parameters is just a step away.

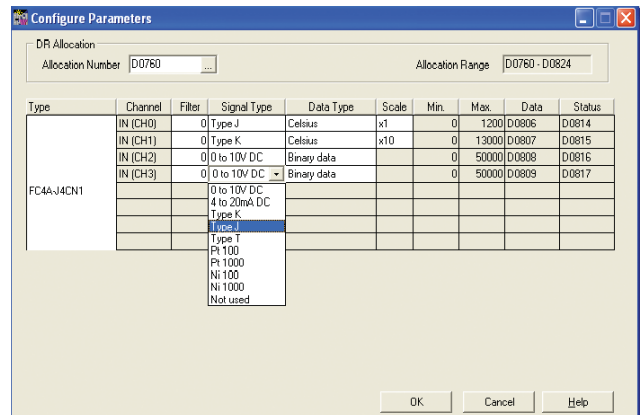

### Compact & Modular Design

PLCs

Operator Interfaces

Automation Software

#### All-in-One CPU



Optional RS232C adapter



Optional RS485 adapter



Optional RS485 adapter - screw type

Built-in RS232C port      Built-in Potentiometers (x2)



All-in-one CPU



Optional HMI module for monitoring



FC5A-C24R2C



Optional EEPROM memory cartridge

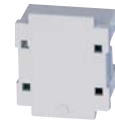

Optional Real Time Clock cartridge

#### Slim CPU

Optional HMI module for monitoring



Optional HMI base module or RS232C/RS485 Comm. Modules



Built-in Potentiometer

Built-in 0-10V analog input

Optional RS232C adapter



Optional RS485 adapter



Optional RS485 adapter - screw type



Built-in RS232C port

Slim CPU



Optional Real Time Clock cartridge

Optional EEPROM memory cartridge

Power Supplies

Sensors

Communication & Networking

MicroSmart Pentra CPU Part Numbers

All-in-One

Appearance	Part Number	Power	I/O Points	Input	Output	Expandability
	FC5A-C10R2C	24V DC	10 (6 in/4 out)	24V DC (Sink/Source)	Relay	N/A
	FC5A-C10R2	100-240V AC				
	FC5A-C16R2C	24V DC	16 (9 in/7 out)			
	FC5A-C16R2	100-240V AC				
	FC5A-C24R2C	24V DC	24 (14 in/10 out)			
	FC5A-C24R2	100-240V AC				

Slim

Appearance	Part Number	Power	I/O Points	Input	Output	Expandability
	FC5A-D16RK1	24V DC	16 (8 in/8 out)	24V DC (Sink/Source)	6 Relays, 2 Transistor Sink	496 Maximum I/O (up to 15 expansion modules)
	FC5A-D16RS1				6 Relays, 2 Transistor Source	
	FC5A-D32K3*		32 (16 in/16 out)		Transistor Sink	512 Maximum I/O (up to 15 expansion modules)
	FC5A-D32S3*					



\*See page 20 for MIL Connector Cables and Breakout Modules.

PLCs

Operator Interfaces

Automation Software

Power Supplies

Sensors

Communication & Networking

### MicroSmart Performance

**Features:**

- Available in 10, 16, 20, 24, and 40 I/O CPUs.
- PID Controls
  - Program up to 14 PID loops
- High Speed I/O
  - Built-in 4 high speed inputs
  - Single or Dual Phase
  - Max. 20KHz frequency
- Built-in 2 High speed outputs (Slim model only)
- Configure up to 264 I/O Points
- Data link up to 32 MicroSmart and Pentra CPUs
- Using RS485 communication module/port, you can create a network of up to 32 CPUs.
- Worldwide Approvals
  - cULus listed, CE marked
  - Class 1 Div. 2 for hazardous locations
  - Lloyds Registered and ABS approved for shipping industry



PLCs

Operator Interfaces

Automation Software

Power Supplies

Sensors

Communication & Networking

### MicroSmart CPU Part Numbers

**All-in-One**

Appearance	Part Number	Power	I/O Points	Input	Output	Expandability	
	FC4A-C10R2C	24V DC	10 (6 in/ 4 out)			N/A	
	FC4A-C10R2	100-240V AC					
	FC4A-C16R2C	24V DC	16 (9 in/ 7 out)	24V DC (Sink/Source)	Relay		
	FC4A-C16R2	100-240V AC					
	FC4A-C24R2C	24V DC	24 (14 in/ 10 out)				88 Maximum I/O (up to 4 expansion modules)
	FC4A-C24R2	100-240V AC					



MicroSmart CPU Part Numbers

Appearance	Part Number	Power	I/O Points	Input	Output	Expandability		
	FC4A-D20RK1	24V DC	20 (12 in/8 out)	24V DC (Sink/Source)	6 Relays, 2 Transistor Sink	244 Maximum I/O (up to 7 expansion modules)		
	FC4A-D20RS1				6 Relays, 2 Transistor Source			
	FC4A-D20K3				Transistor Sink		148 Maximum I/O (up to 7 expansion modules)	
	FC4A-D20S3							Transistor Source
	FC4A-D40K3				40 (24 in/16 out)			264 Maximum I/O (up to 7 expansion modules)
	FC4A-D40S3							

PLCs

Operator Interfaces

Automation Software

Power Supplies

Sensors





Communication & Networking

### Digital I/O Expansion Modules

**Features:**

- 15 modules to choose from
- Available with Screw or MIL connectors
- Easy snap-on
- Available 8, 16 or 32 point modules
- Up to 512 I/O can be configured in the Pentra and 264 I/O in the MicroSmart system

**Input Modules**

Appearance	Part Number	Input	Input Points	Terminal
	FC4A-N08A11	100-120V AC	8	Removable Screw Terminals
	FC4A-N08B1			
	FC4A-N16B1	24V DC	16	MIL Connector (ribbon cable)
	FC4A-N16B3			
	FC4A-N32B3		32	

PLCs

Operator Interfaces

Automation Software





Power Supplies

Sensors

Communication & Networking

### Digital I/O Expansion Modules

#### Output Modules

Appearance	Part Number	Output	Output Points	Terminal
	FC4A-R081	Relay	8	Removable Screw Terminals
	FC4A-R161		16	
	FC4A-T08K1	Transistor Sink	8	MIL Connector (ribbon cable)
	FC4A-T16K3		16	
	FC4A-T32K3		32	

PLCs

Operator Interfaces

Automation Software



Power Supplies

Sensors



Communication & Networking

### Digital I/O Expansion Modules

#### Output Modules (cont.)

Appearance	Part Number	Output	Output Points	Terminal
	FC4A-T08S1		8	Removable Screw Terminals
	FC4A-T16S3	Transistor Source	16	MIL Connector (ribbon cable)
	FC4A-T32S3		32	

#### Combination I/O Modules

Appearance	Part Number	Input	Output	I/O Points	Terminal
	FC4A-M08BR1	24V DC (Sink/Source)	Relay	8 (4 in/4 out)	Removable Screw Terminals
	FC4A-M24BR2			24 (16 in/ 8 out)	Wire Spring Clamp

PLCs

Operator Interfaces

Automation Software

Power Supplies

Sensors

Communication & Networking

## Analog I/O Expansion Modules

**Features:**

- 8 modules
- 0-10V, 4-20mA, RTD, Thermocouple, Thermistor inputs, 0-10V DC or -10V DC to 10V DC output
- 12 or 16-bit resolution
- Fast conversion time
- Maximum of 56 I/O can be configured in the MicroSmart Pentra system
- Easy to configure using a Macro instruction in WindLDR

**Modules**

Appearance	Part Number	I/O Points	Input	Output	Resolution	Terminal
	FC4A-J8C1	8 (8 inputs)		–	16-bit (0-50000)	
	FC4A-L03A1	3 (2 inputs, 1 output)	0-10V DC, 4-20mA	0-10V DC, 4-20mA	12-bit (0-4095)	
	FC4A-J2A1	2 (2 inputs)		–		Removable Screw Terminals
	FC4A-J4CN1	4 (4 inputs)	0-10V DC, 4-20mA, RTD, Thermocouple	–	16-bit (0-50000)	
	FC4A-L03AP1	3 (2 inputs, 1 output)	RTD, Thermocouple	0-10V DC, 4-20mA	12-bit (0-4095)	

PLCs

Operator Interfaces

Automation Software



Power Supplies

Sensors

Communication & Networking

### Analog I/O Expansion Modules

Modules (cont.)

Appearance	Part Number	I/O Points	Input	Output	Resolution	Terminal
	FC4A-J8AT1	8 (8 inputs)	Thermistor (NTC/PTC)	–	12-bit (0-4000)	
	FC4A-K2C1	2 (2 outputs)	–	-10 to 10V DC, 4-20mA	16-bit (0-50000)	Removable Screw Terminals
	FC4A-K1A1	1 (1 output)	–	0-10V DC, 4-20mA	12-bit (0-4095)	

PLCs

Operator Interfaces

Automation Software

Power Supplies

Sensors

Communication & Networking



## Communication Modules

### Web Server Module

#### Features:

- Easy to configure
- Comes with interface cable and Quick Start Guide

#### Part Numbers

Appearance	Part Number	Description
	FC4A-ENET	Web Server Module (includes cable and Quick Start Guide)
	FC9Y-QS100-0	Quick Start Guide

#### Remote Maintenance

- Easily monitor machine conditions, change machine configurations, or upload and download user programs from anywhere, using IDEC WindLDR software over an Ethernet network.
- For a more graphical display and remote data archiving, OPC servers, such as IDEC WindSRV or standard SCADA software, can be used.
- Save time and money:
  - Access system parameters from your desk, conference room or home to check machine status without walking the factory floor.
  - If a machine is down, you no longer need to send someone with their laptop to debug or download a new user program.

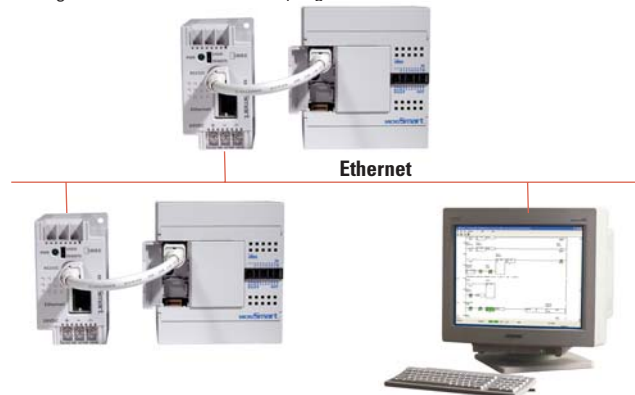

#### Web Server Functions

- Machine status can be monitored and controlled from any PC using standard internet browsers, such as Internet Explorer.
- A built-in custom template, which allows you to monitor and change system parameters, is included.
- Get more flexibility and control by creating your own custom webpage.

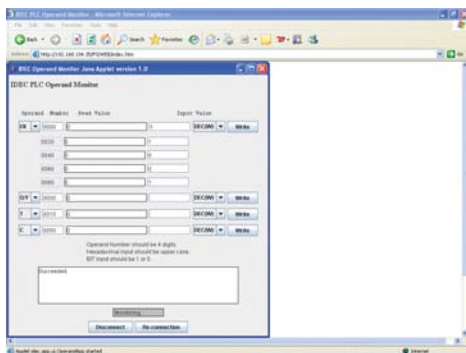

#### Alarm Messaging

Real-time updates of error status or process conditions can be sent to an email address or cellular phone.

- A maximum of 32 customizable messages can be pre-defined with up to two email addresses each.



#### O/I Connectivity

- Using the IDEC Web Server Module on an Ethernet network, an IDEC PLC can be configured as a host to an IDEC operator interface. This allows the touchscreen and PLC to be in separate locations.
- No longer hassle with specialized cables and serial connection limitations.

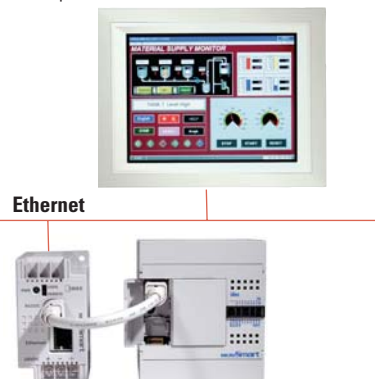

**Communication Modules**  
**AS-Interface Module**

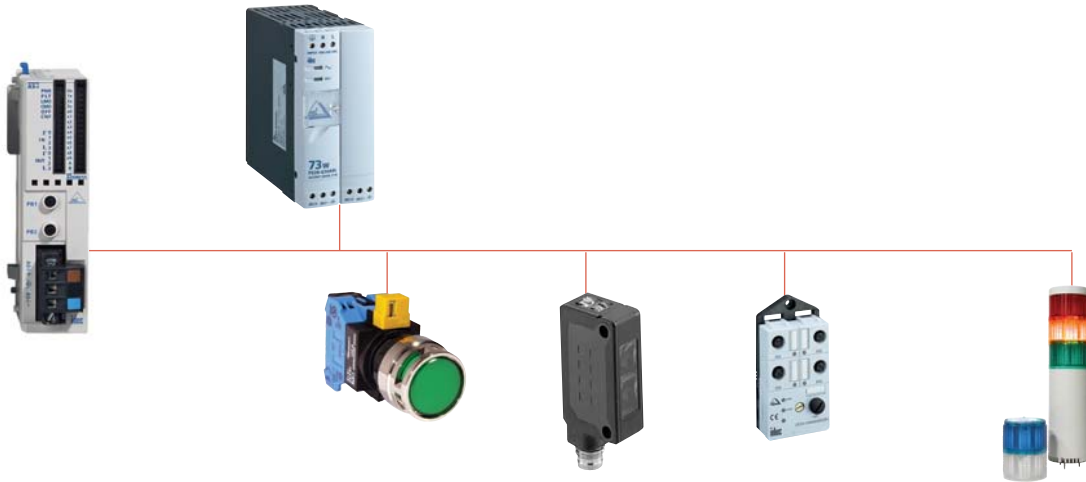

**AS-Interface Master Module**

Appearance	Part Number	Description
	FC4A-AS62M	MicroSmart AS-Interface Master Module

The Actuator Sensor-interface (AS-Interface) is the simplest and most cost-effective of the PLC-based, industrial-networking protocols. AS-Interface is a truly open, low-cost electromechanical connection system designed to operate over a two-wire cable carrying data and power over a distance of up to 100m. It is especially suitable for lower levels of plant automation where simple - often binary (On/Off) - field devices such as switches, sensors, and actuators need to interoperate in a local area automation network controlled by a PLC. IDEC supports this open technology.

IDEC offers a plug-in AS-Interface master module (as well as other AS-Interface devices, please see AS-Interface Communication section) that is easy to configure; it can also connect up to 62 slaves. With this technology, you'll reduce the amount of engineering needed, simplify wiring and enhance your operations; requiring less maintenance. With an average cost of savings of 15 to 40% compared with traditional cabling methods, using an IDEC AS-Interface module is the easy choice.

**Master-Slave Principle**

The AS-Interface master controls and monitors the status of slave devices connected to the AS-Interface bus. Normally, the AS-Interface master is connected to a PLC (sometimes called 'host') or a gateway.

Various types of slave devices can be connected to the AS-Interface bus, including sensors, actuators, and remote I/O devices. Analog slaves can also be connected to process analog data. Slaves are available in standard slaves and A/B slaves. Standard slaves have an address of 1 through 31 in the standard address

range. A/B slaves have an address of 1A through 31A in the standard address range or 1B through 31B in the expanded address range. Among the A/B slaves, slaves with an address of

1A through 31A are called A slaves, and slaves with an address of 1B through 31B are called B slaves. (see AS-Interface Communication section for more details)

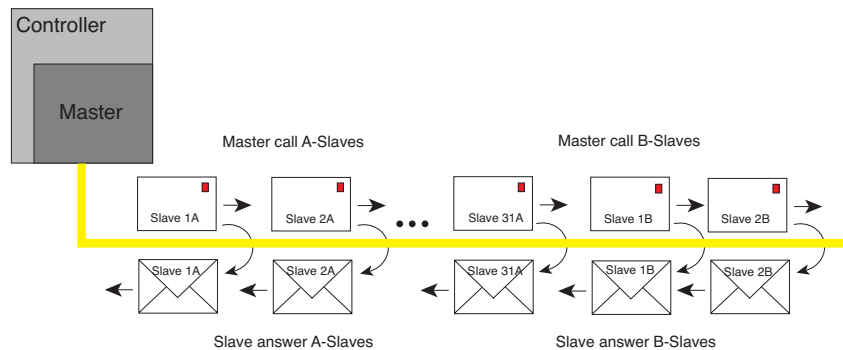



**AS-Interface Module con't**

**High Reliability and Security**

The AS-Interface employs a transfer process of high reliability and high security. The master monitors the AS-Interface power supply voltage and data transmitted on the line, and detects slave failures and data errors. Even when a slave is replaced or a new slave is added during operation, the master can continue uninterrupted communication with other active slaves on the bus.

**MicroSmart AS-Interface Master Module — The Right Choice**

- Compliant with AS-Interface Ver. 2.1 specifications
- Digital and analog slaves can be connected.
- Configuration and slave monitoring can be done using the LED indicators and pushbuttons on the front panel as well as using WindLDR software.
- Maximum of 2 AS-Interface master modules can be used in the MicroSmart Pentra system.

**AS-Interface Bus Topology and Maximum Length**

The AS-Interface bus topology is flexible, and you can wire the bus freely according to your requirements. Bus length can be 100m at the maximum.

**AS-Interface — The Perfect Solution**

- Cost Effective
- Reliable and Safe
- Real-time capable
- Easy to install
- Easy to expand
- Safe against interference
- No limit to the bus structure
- Star, Line or Tree structure can be constructed
- Up to 100m, extendable up to 300m using repeaters

**FC5A-SIF2 RS232C Communication Module**

Appearance	Part Number	Description
	FC5A-SIF2	RS232C Communication Module for MicroSmart Pentra

**Communicate with up to seven different serial devices**

Only IDEC offers communication modules that enable you to configure up to seven serial devices! Now you can connect your operator interface, PC, barcode reader, RFID equipment, printer and more. Just imagine the possibilities.

Using the MicroSmart Pentra slim CPU, you can configure up to seven communication ports. Using the All-in-one MicroSmart Pentra you can communicate with up to five serial devices.



PLCs

Operator Interfaces

Automation Software





Power Supplies

Sensors

Communication & Networking

**Optional Modules**

PLCs



Appearance	Part Number	Description	Usage
	FC4A-HPH1	HMI Base Module	For mounting HMI module and communication ports with slim model CPU module (HMI module is not included)
	FC4A-PH1	HMI Module	For displaying and changing operands
	FC4A-PM32	EEPROM memory cartridge	32KB EEPROM memory cartridge
	FC4A-PM64	EEPROM memory cartridge	64KB EEPROM memory cartridge
	FC4A-PT1	Clock cartridge	Real-time clock cartridge

Operator Interfaces

Automation Software

Power Supplies

**Communication Ports**

Appearance	Part Number	Description	Terminal
	FC4A-PC1	RS232C	Mini DIN
	FC4A-PC2	RS485	Mini DIN
	FC4A-PC3	RS485	Screw Terminal

Sensors

Communication & Networking

### Optional Modules

#### Communication Module — for Slim CPU

Appearance	Part Number	Description	Terminal
	FC4A-HPC1	RS232C	Mini DIN
	FC4A-HPC2	RS485	Mini DIN
	FC4A-HPC3	RS485	Screw Terminal

#### Expansion Power Supply Module

Appearance	Part Number	Description
	FC5A-EXM1M	Master Expansion Power Supply For MicroSmart Pentra
	FC5A-EXM1S	Slave Expansion Power Supply For MicroSmart Pentra
	FC5A-EXM2	Expansion Power Supply For MicroSmart Pentra

### Expansion Power Supply System Configuration

#### FC5A-EXM2 (Expansion Interface Module)

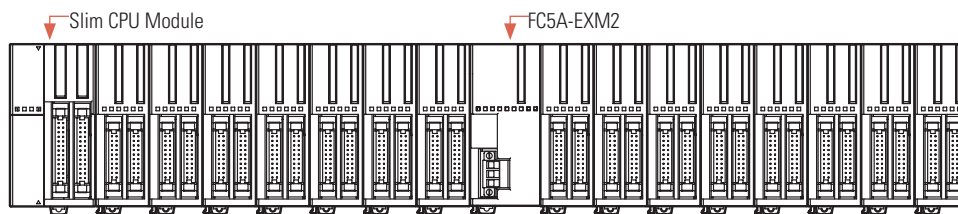

#### FC5A-EXM1M and FC5A-EXM1S (Expansion Interface Master & Slave Modules)

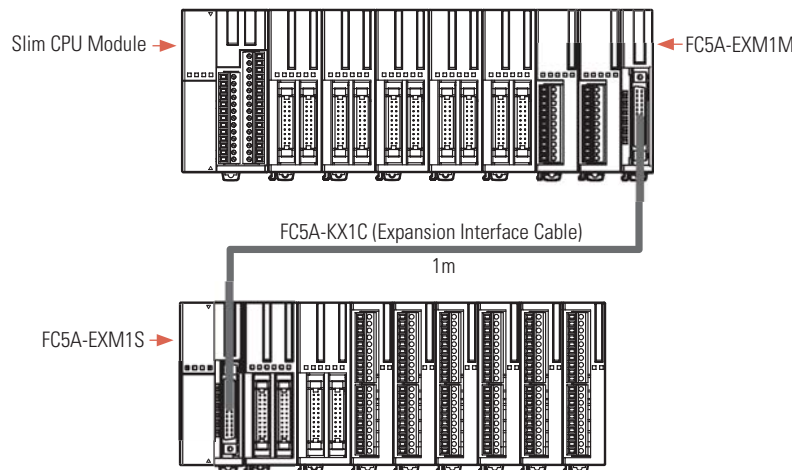

PLCs

Operator Interfaces

Automation Software

Power Supplies

Sensors

Communication & Networking

## Cables

### Communication Cables

Appearance	Part Number	Length	Expanded Description
	FC4A-KC4CA	5ft. (1.53m)	Programming cable (Maintenance/User Communication Mode selectable)
	FC4A-USB	6ft. (1.83m)	USB to Serial Converter (for use with PC without serial port)
	FC4A-KC3C	0.33ft. (100mm)	Web Server Module interface cable

Appearance	Part Number	Length	Expanded Description
	FC2A-KM1C	9.84 Ft. (3m)	Modem cable. Used to connect a modem to the MicroSmart RS232C port.
	FC2A-KP1C	9.84 Ft. (3m)	User communication cable. Used to connect RS232C equipment to the MicroSmart RS232C port.
	FC5A-KX1C	3.28 Ft. (1m)	MicroSmart Pentra expansion power supply interface cable. Used to connect expansion interface master and expansion slave modules.

### MIL Connector Cables (use with Breakout Modules)

Use with	Part Number	Model	Length
CPU Module (26-wire) BX1D-S26A, BX1D-T26A	FC9Z-H050B26	Non-shielded	1.64ft. (0.5m)
	FC9Z-H100B26		3.28ft. (1m)
	FC9Z-H200B26		6.56ft (2m)
	FC9Z-H300B26		9.85ft. (3m)
	FC9Z-H050A26	Shielded	1.64ft. (0.5m)
	FC9Z-H100A26		3.28ft. (1m)
	FC9Z-H200A26		6.56ft (2m)
	FC9Z-H300A26		9.85ft. (3m)
FC9Z-H100C26A	Shielded Single Connectors	5ft. (1.5m)	

Use with	Part Number	Model	Length
I/O Expansion Modules (20-wire) BX1D-S20A, BX1D-T20A	FC9Z-H050B20	Non-shielded	1.64ft. (0.5m)
	FC9Z-H100B20		3.28ft. (1m)
	FC9Z-H200B20		6.56ft (2m)
	FC9Z-H300B20		9.85ft. (3m)
	FC9Z-H050A20	Shielded	1.64ft. (0.5m)
	FC9Z-H100A20		3.28ft. (1m)
	FC9Z-H200A20		6.56ft (2m)
	FC9Z-H300A20		9.85ft. (3m)
FC9Z-H100C20A	Shielded Single Connectors	5ft. (1.5m)	

### Breakout Modules

Use with	Part Number	Description
26-wire MIL connector cable 	BX1D-S26A	26-terminal breakout module
	BX1D-T26A	26-terminal touch-down terminal breakout module
20-wire MIL connector cable 	BX1D-S20A	20-terminal breakout module
	BX1D-T20A	20-terminal touch-down terminal breakout module

PLCs

Operator Interfaces

Automation Software

Power Supplies

Sensors

Communication &amp; Networking

### Accessories

Part Number	Use with	Description
FC4A-PMT13P	CPU module	13-position left-side terminal block for FC4A-D20RK1/-D20RS1 CPU
FC5A-PMT13P		13-position left-side terminal block for FC5A-D16RK1/-D16RS1 CPU
FC4A-PMTS16P		16-position right-side terminal block for FC4A-D20RS1 and FC5A-D16RS1 CPU
FC4A-PMTK16P		16-position right-side terminal block for FC4A-D20RK1 and FC5A-D16RK1 CPU
FC4A-PMT11P	I/O expansion modules	11-position terminal block for 8-pt I/O expansion modules
FC4A-PMT10P		10-position terminal block for 16-pt I/O expansion modules
FC4A-PMC20P		20-position connector socket for MIL connector I/O expansion modules
FC4A-PMC26P		26-position connector socket for MIL connector CPU modules
FC4A-PSP1P		Direct mounting strips for mounting on a panel
FC4A-PMAC2P		Analog voltage input cable for slim CPU
FC4A-DS824-SW14		14-pt input simulator switch for 24 I/O CPU
FC4A-DS824-SW9		9-pt input simulator switch for 16 I/O CPU
FC4A-DS824-SW6		6-pt input simulator switch for 10 I/O CPU
BNL6		End clips
BNDN1000		DIN Rail (1m/3.28' long, 10.5mm height)
BAA1000		DIN Rail (1m/3.28' long, 7.5mm height)
FC9Z-SD2		2.5mm flathead IDEC screwdriver
FC9Y-B812-0A		MicroSmart user manual
FC9Y-B927-0		MicroSmart Pentra user manual
FC9Y-B919		Web Server Module user manual
FC9Y-B969-0		FC5A-SIF2 Communication Module user manual
FC9Y-B902-0		Analog I/O user manual
FC9Y-LP2CDW		WindLDR PLC programming software

PLCs

Operator Interfaces

Automation Software



Power Supplies

Sensors







Communication & Networking

## Starter Kits and Solution Packages

### MicroSmart Starter Kits

		Part Numbers	Controller	Power Supply	Software (Prog. Cables Included)
<b>MicroSmart</b>		MM-SMART-10	10 I/O All-in-One CPU	–	WindLDR
		MM-SMART-16	16 I/O All-in-One CPU	–	WindLDR
		MM-SMART-20	20 I/O Slim CPU	15W	WindLDR
		MM-SMART-24	24 I/O All-in-One CPU	–	WindLDR
		MM-SMART-40	40 I/O Slim CPU	15W	WindLDR
<b>MicroSmart Pentra</b>		MM-PENTRA-16	16 I/Os Slim CPU	30W	WindLDR
		MM-PENTRA-24	24 I/Os All-in-One CPU	–	WindLDR

### MicroSmart Solution Packages

		Part Numbers	Operator Interface*	Controller	Power Supply
<b>MicroSmart</b>		MM-SMART-16-HG2F-M	HG2F 5.7" Mono STN	16 I/O All-in-One CPU	15W
		MM-SMART-20-HG2F-M	HG2F 5.7" Mono STN	20 I/O Slim CPU	60W
		MM-SMART-24-HG2F-M	HG2F 5.7" Mono STN	24 I/O All-in-One CPU	15W
		MM-SMART-40-HG2F-M	HG2F 5.7" Mono STN	40 I/O Slim CPU	60W
		MM-SMART-16-HG2F-C	HG2F 5.7" Color STN	16 I/O All-in-One CPU	15W
		MM-SMART-20-HG2F-C	HG2F 5.7" Color STN	20 I/O Slim CPU	60W
		MM-SMART-24-HG2F-C	HG2F 5.7" Color STN	24 I/O All-in-One CPU	15W
		MM-SMART-40-HG2F-C	HG2F 5.7" Color STN	40 I/O Slim CPU	60W
		MM-SMART-20-HG3F	HG3F 10.4" Color TFT	20 I/O Slim CPU	60W
		MM-SMART-24-HG3F	HG3F 10.4" Color TFT	24 I/O All-in-One CPU	60W
		MM-SMART-20-HG4F	HG4F 12.1" Color TFT	20 I/O Slim CPU	60W
		MM-SMART-24-HG4F	HG4F 12.1" Color TFT	24 I/O All-in-One CPU	60W
<b>MicroSmart Pentra</b>		MM-PENTRA-16-HG1F	HG1F 4.6" Mono STN	16 I/O Slim CPU	30W
		MM-PENTRA-24-HG1F	HG1F 4.6" Mono STN	24 I/O All-in-One CPU	30W
		MM-PENTRA-16-HG2F-C	HG2F 5.7" Color STN	16 I/O Slim CPU	30W
		MM-PENTRA-24-HG2F-C	HG2F 5.7" Color STN	24 I/O All-in-One CPU	30W
		MM-PENTRA-16-HG3F	HG3F 10.4" Color TFT	16 I/O Slim CPU	30W
		MM-PENTRA-24-HG3F	HG3F 10.4" Color TFT	24 I/O All-in-One CPU	30W
		MM-PENTRA-16-HG4F	HG4F 12.1" Color TFT	16 I/O Slim CPU	30W
		MM-PENTRA-24-HG4F	HG4F 12.1" Color TFT	24 I/O All-in-One CPU	30W



- \*HG1F: Light Gray Bezel, RS232 Comm., HG2F/3F/4F: Light Gray Bezel.
- All packages come with WindLDR & WindO/I-NV2 software, programming and interface cables.

## WindLDR Programming Software

Unique ladder logic programming tool designed to program all IDEC PLCs

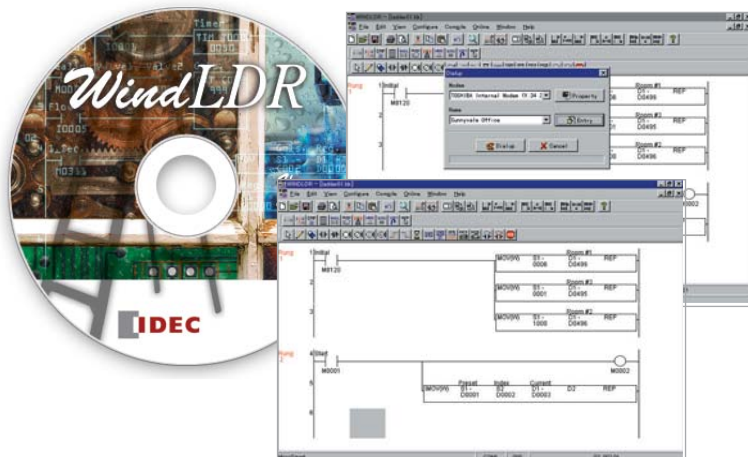

### Part Number

Part Number	Description
FC9Y-LP2CDW	WindLDR PLC programming software

### Single Platform for all IDEC PLCs

WindLDR is an excellent, long-term investment for your control solutions. It programs every IDEC PLC including the OpenNet Controller, MicroSmart and the fastest micro-controller on the market, MicroSmart Pentra. It's adaptable to whatever hardware you need today and down the road.

### Simple-to-use Editors

Use the tag editor to access and edit coil data. Edit comments and rung comments. Simulation mode tests your program in WindLDR to guarantee that it works the way you expected, before downloading it to your PLC.

### User-friendly Interfaces

Icon-based toolbars and drag-and-drop functionality make basic ladder programming accessible to anyone. But WindLDR also shows you how to display parameters and settings and how to input your parameters, and the built-in shortcuts and tutorials will keep you on the right track.

### Free Lifetime Upgrade

Not only is WindLDR the easiest and most convenient ladder programming software on the market, it also comes with a very special price with no strings attached. Our software comes with a free-lifetime upgrade. That means that you no longer need to spend thousands of dollars for software that has to be renewed every year costing you additional money. Save yourself money by using an IDEC PLC and WindLDR programming software.

For more information, see the Automation Software section.  
Visit [www.idec.com/downloads](http://www.idec.com/downloads) for free upgrades or a free 30-day trial version.

PLCs

Operator Interfaces

Automation Software

Power Supplies

Sensors

Communication & Networking

### Specifications

**All-in-One**

Part Number	AC Power	FC5A-C10R2	FC5A-C16R2	FC5A-C24R2	FC4A-C10R2	FC4A-C16R2	FC4A-C24R2
	DC Power	FC5A-C10R2C	FC5A-C16R2C	FC5A-C24R2C	FC4A-C10R2C	FC4A-C16R2C	FC4A-C24R2C
Rated Voltage	AC power model: 100 to 240V AC, DC power model: 24V DC						
Allowable Voltage Range	AC power model: 85 to 264V AC, DC power model: 20.4 to 28.8V DC (including ripple)						
Rated Power Frequency	AC power model: 50/60 Hz (47 to 63 Hz)						
Maximum Input Current	250mA (85V AC) 160mA (24V DC)	300mA (85V AC) 190mA (24V DC)	450mA (85V AC) <sup>1</sup> 360mA (24V DC) <sup>2</sup>	250mA (85V AC) 160mA (24V DC)	300mA (85V AC) 190mA (24V DC)	450mA (85V AC) <sup>2</sup> 360mA (24V DC) <sup>3</sup>	
Maximum Power Consumption	AC Power	FC5A-C10R2/FC4A-C10R2: 30VA (264V AC) / 20VA (100V AC) <sup>3</sup> FC5A-C16R2/FC4A-C16R2: 31VA (264 V AC) / 22VA (100V AC) <sup>3</sup> FC5A-C24R2/FC4A-C24R2: 40VA (264V AC) / 33VA (100V AC) <sup>1</sup>					
	DC Power	FC5A-C10R2C/FC4A-C10R2C: 3.9W (24V DC) <sup>4</sup> FC5A-C16R2C/FC4A-C16R2C: 4.6W (24V DC) <sup>4</sup> FC5A-C24R2C/FC4A-C24R2C: 8.7W (24V DC) <sup>2</sup>					
Allowable Momentary Power Interruption	10ms (rated power voltage)						
Dielectric Strength	Between power and ⊕ or ⊖ terminals: 1500V AC, 1 minute Between I/O and ⊕ or ⊖ terminals: 1500V AC, 1 minute						
Insulation Resistance	Between power and ⊕ or ⊖ terminals: 10 MΩ minimum (500V DC megger) Between I/O and ⊕ or ⊖ terminals: 10 MΩ minimum (500V DC megger)						
Noise Resistance	AC power terminals: 1.5 kV, 50 ns to 1μs DC power terminals: 1.0 kV, 50 ns to 1μs I/O terminals (coupling clamp): 1.5 kV, 50 ns to 1μs						
Inrush Current		35A	40A	35A	40A		
Power Supply Wire	UL1015 AWG22, UL1007 AWG18						
Operating Temperature	0 to 55°C						
Storage Temperature	-25 to +70°C (no freezing)						
Relative Humidity	Level RH1 (IEC61131-2), 1 to 95% RH (no condensation)						
Altitude	Operation: 0 to 2,000m, Transport: 0 to 3,000m						
Pollution Degree	2 (IEC60664-1)						
Corrosion Immunity	Free from corrosive gases						
Degree of Protection	IP20 (IEC60529)						
Grounding Wire	UL1007, AWG16						
Vibration Resistance	When mounted on a DIN rail or panel surface: 5 to 9 Hz amplitude 3.5 mm, 9 to 150 Hz acceleration 9.8 m/s <sup>2</sup> (1G), 2 hours per axis on each of three mutually perpendicular axes (IEC61131-2)						
Shock Resistance	147 m/s <sup>2</sup> (15G), 11ms duration, 3 shocks per axis, on three mutually perpendicular axes (IEC61131)						
Weight	AC: 230g DC: 240g	AC: 250g DC: 260g	AC: 305g DC: 310g	AC: 230g DC: 240g	AC: 250g DC: 260g	AC: 305g DC: 310g	

- 1. CPU module (including 250mA sensor power) + 4 I/O modules
- 2. CPU module + 4 I/O modules
- 3. CPU module (including 250mA sensor power)
- 4. CPU module (24V DC)

PLCs

Operator Interfaces

Automation Software

Power Supplies

Sensors

Communication &amp; Networking



Slim

Part Number		FC5A-D16RK1 FC5A-D16RS1	FC5A-D32K3 FC5A-D32S3	FC4A-D20K3 FC4A-D20S3	FC4A-D20RK1 FC4A-D20RS1	FC4A-D40K3 FC4A-D40S3					
Control System		Stored program system									
Instruction Words		35 basic									
Program Capacity <sup>1</sup>		88 advanced	92 advanced	55 advanced	72 advanced						
User Program Storage		EEPROM (10,000 times rewritable)									
Processing Time	Basic Instruction	83µs (1,000 steps)			1.65ms (1,000 steps)						
	END Processing <sup>3</sup>	0.35ms			0.64ms						
Expandable I/O Modules		7 modules + additional 8 modules using the expansion power supply module			7 modules						
I/O Points	Input	8	Expansion: 224 Additional: 256	16	Expansion: 224 Additional: 256	12	Expansion: 128	12	Expansion: 224	24	Expansion: 224
	Output	8	Expansion: 224 Additional: 256	16	Expansion: 224 Additional: 256	8	Expansion: 128	8	Expansion: 224	16	Expansion: 224
Internal Relay		2,048 points			1,024 points						
Shift Register		256 points			128 points						
Data Register		42,000 points <sup>4</sup>			1,300 points						
Expansion Data Register		6,000 points			—			6,000 points			
Counter		256 points			100 points						
Timer (1-sec, 100-ms, 10-ms, 1-ms)		256 points			100 points						
RAM Backup	Backup Data	Internal relay, shift register, counter, data register, expansion data register									
	Backup Duration	Approx. 30 days (typical) at 25°C after backup battery fully charged									
	Battery	Lithium secondary battery									
	Charging Time	Approx. 15 hours for charging from 0% to 90% of full charge									
	Battery Life	5 years									
Replaceability		N/A									
Self-diagnostic Function		Power failure, watchdog timer, data link connection, user program EEPROM sum check, timer/counter preset value sum check, user program RAM sum check, keep data, user program syntax, user program writing, CPU module, clock IC, I/O bus initialize, user program execution									
Input Filter		Without filter or 3 to 15ms filter (selectable in increments of 1ms)									
Catch Input/Interrupt Input		Four inputs (I2 through I5) Minimum turn on pulse width: 5µs minimum Minimum turn off pulse width: 5µs minimum			Four inputs (I2 through I5) Minimum turn on pulse width: 40µs minimum Minimum turn off pulse width: 150µs minimum						
High-speed Counter	Maximum Counting Frequency and High-speed Counter Points	Total 4 points Single/two-phase selectable: 100 KHz (2 points) Single-phase: 100 KHz (2 points)			Total 4 points Single/two-phase selectable: 20 KHz (2 points) Single-phase: 5 KHz (2 points)						
	Counting Range	0 to 4294967295 (32 bits)			0 to 65535 (16 bits)						
	Operation Mode	Rotary encoder mode and adding counter mode									
Analog Potentiometer	Number	1 point									
	Data Range	0 to 255									
Analog Voltage Input	Number	1 point									
	Input Voltage Range	0 to 10V DC									
	Input Impedance	Approx. 100kΩ									
	Data Range	0 to 255 (8 bits)									
Pulse Output	Number	2 points	3 points	2 points							
	Maximum Frequency	100KHz			20KHz						
Sensor Power Supply	Output Voltage Current	—									
	Overload Detection	—									
	Isolation	—									
Port 1		RS232C (maintenance communication, user communications)									
Port 2 Communication Adapter (option) <sup>5</sup>		Possible	Possible	Possible	Possible	Possible					
Clock Cartridge (option)		Possible	Possible	Possible	Possible	Possible					
Memory Cartridge (option)		Possible	Possible	Possible	Possible	Possible					
HMI Module (option)		Possible	Possible	Possible	Possible	Possible					



- 1 step equals 6 bytes.
- Expandable up to 64 KB when a memory cartridge is used.
- Not including expansion I/O service time, clock function processing time, data link processing time, and interrupt processing time.
- Extra data registers D10000 through D49999 are enabled using WindLDR Function Area Settings, then run-time program download cannot be used.
- Maintenance communication, user communication, Modem communication, data link, Modbus master/slave communication (FC5A only).  
Note: The maximum number of relay outputs that can be turned on simultaneously is 54 including those on the CPU module.

PLCs

Operator Interfaces

Automation Software

Power Supplies

Sensors

Communication & Networking

**All-in-One**

Part Number		FC5A-C10R2 FC5A-C10R2C	FC5A-C16R2 FC5A-C16R2C	FC5A-C24R2 FC5A-C24R2C	FC4A-C10R2 FC4A-C10R2C	FC4A-C16R2 FC4A-C16R2C	FC4A-C24R2 FC4A-C24R2C
Control System		Stored program system					
Instruction Words		35 basic					
Program Capacity <sup>1</sup>		13.8 KB (2,300 steps)	27 KB (4,500 steps)	54 KB (9,000 steps)	4.8 KB (800 steps)	15 KB (2,500 steps)	27 KB (4,500 steps)
User Program Storage		EEPROM (10,000 times rewritable)					
Processing Time	Basic Instruction	1.16ms (1,000 steps)			1.65ms (1,000 steps)		
	END Processing <sup>2</sup>	0.64ms			0.64ms		
Expandable I/O Module		—		4 modules		—	
I/O Points	Input	6	9	14	Expansion: 64	6	9
	Output	4	7	10		4	7
Internal Relay		2,048 points		256 points		1,024 points	
Shift Register		128 points		64 points		128 points	
Data Register		2,000 points		400 points		1,300 points	
Extra Data Register		—		—		—	
Counter		256 points		32 points		100 points	
Timer (1-sec, 100-ms, 10-ms, 1-ms)		256 points		32 points		100 points	
RAM Backup	Backup Data	Internal relay, shift register, counter, data register					
	Backup Duration	Approx. 30 days (typical) at 25°C after backup battery fully charged					
	Battery	Lithium secondary battery					
	Charging Time	Approx. 15 hours for charging from 0% to 90% of full charge					
	Battery Life	5 years					
	Replaceability	N/A					
Self-diagnostic Function		Power failure, watchdog timer, data link connection, user program EEPROM sum check, timer/counter preset value sum check, user program RAM sum check, keep data, user program syntax, user program writing, CPU module, clock IC, I/O bus initialize, user program execution					
Input Filter		Without filter or 3 to 15ms filter (selectable in increments of 1ms)					
Catch Input/Interrupt Input		Four inputs (I2 through I5) Minimum turn on pulse width: 40µs minimum Minimum turn off pulse width: 150µs minimum					
High-speed Counter	Maximum Counting Frequency and High-speed Counter Points	Total 4 points Single/two-phase selectable: 50KHz (1 point) Single-phase: 5KHz (3 points)			Total 4 points Single/two-phase selectable: 20KHz (1 point) Single-phase: 5KHz (3 points)		
	Counting Range	0 to 65535 (16 bits)					
	Operation Mode	Rotary encoder mode and adding counter mode					
Analog Potentiometer	Number	1 point		2 points		1 point	
	Data Range	0 to 255					
Analog Voltage Input	Number	—					
	Input Voltage Range	—					
	Input Impedance	—					
Pulse Output	Data Range	—					
	Number	—					
Sensor Power Supply (AC Power Only)	Max. Frequency	—					
	Output Voltage Current	24V DC (+10% to -15%), 250mA					
	Overload Detection	N/A					
Isolation		Isolated from the internal circuit					
Port 1		RS232C (maintenance communication, user communication)					
Port 2 Communication Adapter (option) <sup>3</sup>		Possible	Possible	Possible	—	Possible	Possible
Clock Cartridge (option)		Possible	Possible	Possible	Possible	Possible	Possible
Memory Cartridge (option)		Possible	Possible	Possible	Possible	Possible	Possible
HMI Module (option)		Possible	Possible	Possible	Possible	Possible	Possible



- 1 step equals 6 bytes.
  - Not including expansion I/O service time, clock function processing time, data link processing time, and interrupt processing time.
  - Maintenance communication, user communication, Modem communication, datalink, Modbus master/slave communication (FC5A only).
- Note: The maximum number of relay outputs that can be turned on simultaneously is 33 including those on the CPU module.

Communication Port (RS232C Port 1)

Model	Slim CPU	All-in-One CPU
Standards	EIA RS232C	
Maximum Baud Rate	FC5A: 57,600 bps (maintenance communication) FC4A: 19,200 bps (maintenance communication)	
Maintenance Communication	Possible	
User Communication	Possible	
Modem Communication	N/A	
Data Link	N/A	
Cable	Special cable (FC2A-KC4C, FC2A-KP1C, FC4A-KC1C, FC4A-KC2C)	
Isolation between Internal Circuit and Communication Port	Not isolated	

Input Specifications

Part Number	—	FC5A-D16RK1 FC5A-D16RS1	—	FC5A-D32K3 FC5A-D32S3	—	FC5A-C10R2 FC5A-C10R2C	FC5A-C16R2 FC5A-C16R2C	FC5A-C24R2 FC5A-C24R2C
	FC4A-D20K3 FC4A-D20S3	—	FC4A-D20RK1 FC4A-D20RS1	—	FC4A-D40K3 FC4A-D40S3	FC4A-C10R2 FC4A-C10R2C	FC4A-C16R2 FC4A-C16R2C	FC4A-C24R2 FC4A-C24R2C
Input Points	12 (12/1 common)	8 (8/1 common)	12 (12/1 common)	16 (8/1 common)	24 (12/1 common)	6 (6/1 common)	9 (9/1 common)	14 (14/1 common)
Input Voltage	24V DC sink/source input signal							
Input Voltage Range	20.4 to 26.4V DC					20.4 to 28.8V DC		
Input Current	FC5A I0, I1, I3, I4, I6, I7: 4.5mA/point (24V DC) I2, I5, I10 to I17: 7mA/point (24V DC) FC4A I0, I1, I6, I7: 5mA/point (24V DC) I2 to I5, I10 to I27: 7mA/point (24V DC)					FC5A I0 and I1: 6.4mA/point I2 to I7, I10 to I15: 7mA/point (24V DC) FC4A I0 and I1: 11mA I2 to I7, I10 to I15: 7mA/point (24V DC)		
Input Impedance	FC5A I0, I1, I3, I4, I6, I7: 4.9kΩ I2 to I5, I10 to I17: 3.4kΩ FC4A I0, I1, I6, I7: 5.7kΩ I2 to I5, I10 to I17: 3.4kΩ					FC5A I0 and I1: 3.7kΩ I2 to I7, I10 to I15: 3.4kΩ FC4A I0 and I1: 2.1kΩ I2 to I7, I10 to I15: 3.4kΩ		
Turn ON Time	FC5A I0, I1, I3, I4, I6, I7: 5μs + filter value I2 and I5: 35μs + filter value I10 to I17: 40μs + filter value FC4A I0, I1, I6, I7: 35μs + filter value I2 to I5: 35μs + filter value I10 to I27: 40μs + filter value					FC5A I0 and I1: 2μs + filter value I2 to I7: 35μs + filter value I6, I7, I10 to I15: 40μs + filter value FC4A I0 and I1: 35μs + filter value I2 to I5: 35μs + filter value I6, I7, I10 to I15: 40μs + filter value		
Turn OFF Time	FC5A I0, I1, I3, I4, I6, I7: 5μs + filter value I2 and I5: 150μs + filter value I10 to I17: 150μs + filter value FC4A I0, I1, I6, I7: 45μs + filter value I2 to I5: 150μs + filter value I10 to I27: 150μs + filter value					FC5A I0 and I1: 16μs + filter value I2 to I7: 150μs + filter value I6, I7, I10 to I15: 150μs + filter value FC4A I0 and I1: 45μs + filter value I2 to I5: 150μs + filter value I6, I7, I10 to I15: 150μs + filter value		
Connector	On Mother Board	FL26A2MA (Oki Electric Cable)	MC1.5/18-G-3.81BK (Phoenix Contact)	FL26A2MA (Oki Electric Cable)	—			
	Insertion Durability	100 times minimum					—	
Isolation	Between input terminals: Photocoupler isolated Internal circuit: Not isolated							
Input	Type 1 (IEC61131-2)							
External Load for I/O Interconnection	Not needed							
Single Determination Method	Static							
Effect of Improper Input Connection	Both sinking and sourcing input signals can be connected. If any input exceeding the rated value is applied, permanent damage may be caused.							
Cable Length	3 m in compliance with electromagnetic immunity							

**PLCs**
**Operator Interfaces**
**Automation Software**
**Power Supplies**
**Sensors**
**Communication & Networking**
**Transistor Sink and Source Output**

Part Number	—	FC5A-D16RK1 FC5A-D16RS1	FC5A-D32K3 FC5A-D32S3
	FC4A-D20RK1 FC4A-D20RS1	—	FC4A-D40K3 FC4A-D40S3
Output Points	2 (2/1 common)	2 (2/1 common)	16 (8/1 common)
Output	Transistor Sink	FC5A-D16K1/D32K3 FC4A-D20K3/D20RK1/D40K3	
	Transistor Source	FC5A-D16RS1/D32S3 FC4A-D20S3/D20RS1/D40S3	
Load Voltage	24V DC		
Operating Load Voltage Range	20.4 to 28.8V DC		
Load Current	0.3A per output point		
Maximum Load Current	1A per common		
Voltage Drop (ON Voltage)	1V maximum (voltage between COM and output terminals when output is on)		
Inrush Current	1A		
Leakage Current	0.1mA maximum		
Clamping Voltage	39V±1V		
Maximum Lamp Load	8W		
Inductive Load	L/R = 10ms (28.8V DC, 1 Hz)		
External Current Draw	Sink output: 100mA maximum, 24V DC (power voltage at the +V terminal) Source output: 100mA maximum, 24V DC (power voltage at the -V terminal)		
Isolation	Between output terminal and internal circuit: Photocoupler isolated Between output terminals: Not isolated		
Connector on Mother Board	FL26A2MA (Oki Electric Cable)	MC1.5/16-G-3.81BK (Phoenix Contact)	FL26A2MA (Oki Electric Cable)
Connector Insertion/Removal Durability	100 times minimum		
Output Delay	Turn ON Time	FC5A Q0 to Q2: 5µs max. Q3 to Q7, Q10 to Q17: 300µs max. FC4A Q0, Q1: 5µs max. Q2 to Q7, Q10 to Q17: 300µs max.	
	Turn OFF Time	FC5A Q0 to Q2: 5µs max. Q3 to Q7, Q10 to Q17: 300µs max. FC4A Q0, Q1: 5µs max. Q2 to Q7, Q10 to Q17: 300µs max.	

**Relay Output**

Part Number	FC5A-C10R2 FC5A-C10R2C	FC5A-C16R2 FC5A-C16R2C	FC5A-C24R2 FC5A-C24R2C	FC5A-D16RK1 FC5A-D16RS1
	FC4A-C10R2 FC4A-C10R2C	FC4A-C16R2 FC4A-C16R2C	FC4A-C24R2 FC4A-C24R2C	FC4A-D20RK1 FC4A-D20RS1
No. of Outputs	4	7	10	8
Output Points per Common Line	COM0	3	4	4
	COM1	1	2	4
	COM2	—	1	1
	COM3	—	—	1
Output	1 NO form A			
Maximum Load Current	2A per point 8A per common line			
Minimum Switching Load	0.1mA/0.1V DC (reference value)			
Initial Contact Resistance	30 mΩ maximum			
Electrical Life	100,000 operations minimum (rated load 1,800 operations/hour)			
Mechanical Life	20,000,000 operations minimum (no load 18,000 operations/hour)			
Rated Load	240V AC/2A (resistive load, inductive load cos φ = 0.4) 30V DC/2A (resistive load, inductive load L/R = 7ms)			
Dielectric Strength	Between output and terminals: 1,500V AC, 1 minute Between output terminal and internal circuit: 1,500V AC, 1 minute Between output terminals (COMs): 1,500V AC, 1 minute			
Connector on Mother Board	—			*
Connector Insertion/Removal Durability	—			100 times minimum



\*MC1.5/16-G-3.81BK (Phoenix Contact)

Input Usage Limits

FC5A-D16RK1/D16RS1

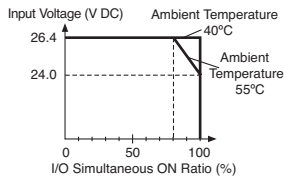

FC5A-D32K3/D32S3  
FC4A-D40K3/D40S3

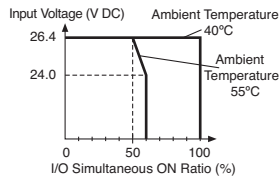

FC4A-D20K3/D20S3

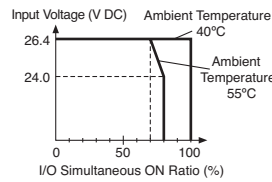

FC4A-D20RK1/D20RS1

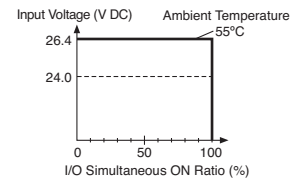

All-in-One CPU

FC5A-C10R2  
FC5A-C10R2C  
FC4A-C10R2  
FC4A-C10R2C

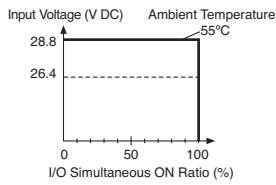

FC5A-C16R2  
FC5A-C16R2C  
FC4A-C16R2  
FC4A-C16R2C

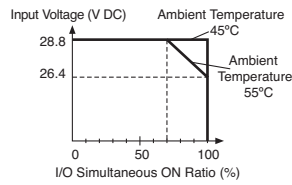

FC5A-C24R2  
FC5A-C24R2C  
FC4A-C24R2  
FC4A-C24R2C

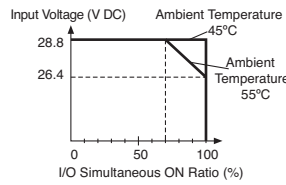

CAUTION: When using at an operating ambient temperature above 40°C, reduce the input voltage or the quantity of I/O points that turn on simultaneously.

Input Internal Circuit

Slim CPU

FC5A: I0, I1, I3, I4, I6, I7  
FC4A: I0, I1, I6, I7

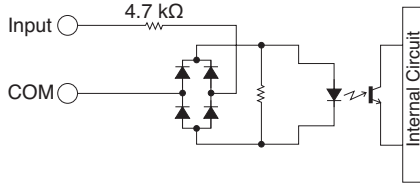

FC5A: I2, I5, I10 to I17  
FC4A: I2 to I5, I10 to I27

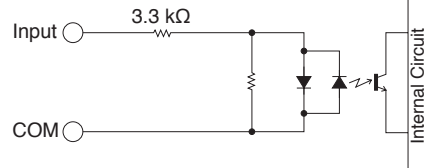

All-in-One CPU

I0, I1  
3.3 kΩ (FC5A)  
1.8 kΩ (FC4A)

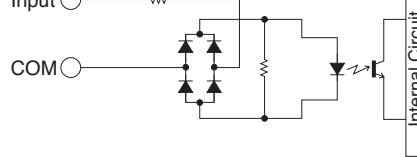

I2 to I15

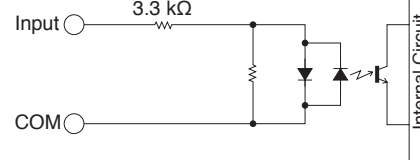

Output Internal Circuit

Slim CPU

Sink Output

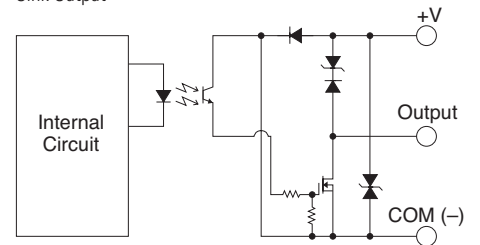

Source Output

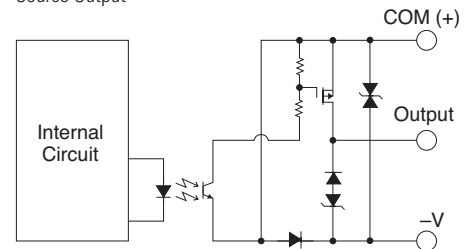

**Communication Adapter/Module**

Part Number	FC4A-PC1 FC4A-HPC1	FC4A-PC2 FC4A-HPC2	FC4A-PC3 FC4A-HPC3
Standards	EIA RS232C	EIA RS485	EIA RS485
Maximum Baud Rate	FC5A: 57600bps FC4A: 19200bps	FC5A: 57600bps FC4A: 19200bps	FC5A: 57600bps FC4A: 19200bps (38400 bps <sup>1</sup> )
Maintenance Communication	Possible	Possible	Possible
User Communication	Possible	—	Possible <sup>2</sup>
Data Link Communication	—	—	Possible
Half-duplex Communication	—	—	Possible
Maximum Cable Length	Special cable <sup>3</sup>	Special cable <sup>4</sup>	200 m
Quantity of Slave Stations	—	—	31
Isolation between Internal Circuit and Communication Port	Not isolated		
Recommended Cable for RS485	—		Twisted-pair shielded cable with a minimum core wire of 0.3 mm <sup>2</sup>
Conductor Resistance	—		85Ω/km maximum
Shield Resistance	—		20Ω/km maximum



1. Maximum speed when data link is used.
2. FC5A (all types), FC4A-D20RK1, FC4A-D20RS1, FC4A-D40K3, FC4A-D40S3
3. FC2A-KC4C, FC2A-KM1C, FC4A-KC1C, FC4A-KC2C, FC2A-KP1C
4. FC2A-KP1C

**HMI Module (Optional)**

Part Number	FC4A-PH1
Power Voltage	5V DC (supplied from the CPU module)
Weight	20g

**Memory Cartridge Specifications (Optional)**

Part Number	FC4A-PM32	FC4A-PM64
Memory	EEPROM	
Accessible Memory Capacity	32 KB	64 KB
Hardware for Storing Data	CPU Module	
Software for Storing Data	WindLDR	
Quantity of Stored Programs	One user program can be stored on one memory cartridge	

**Clock Cartridge (Optional)**

Part Number	FC4A-PT1
Accuracy	±30 sec/month (typical) at 25°C
Backup Duration	Approx. 30 days (typical) at 25°C after backup battery fully charged
Battery	Lithium secondary battery
Charging Time	Approx. 10 hours for charging from 0% to 90% of full charge
Replaceability	N/A

I/O Modules Specifications

Input Module

Part Number	FC4A-N08B1	FC4A-N16B1	FC4A-N16B3	FC4A-N32B3	FC4A-N08A11	
Input Points	8 (8/1 common)	16 (16/1 common)		32 (16/1 common)	8 (4/1 common)	
Input Voltage	24V DC sink/source input signal				100 to 120V AC (50/60 Hz)	
Input Voltage Range	20.4 to 28.8V DC				85 to 132V AC	
Input Current	7mA/point (24V DC)		5mA/point (24V DC)		17mA/point (120V AC, 60 Hz)	
Input Impedance	3.4kΩ		4.4kΩ		0.8kΩ (60 Hz)	
ON Voltage	15V minimum				9V minimum	
OFF Voltage	5V maximum				20V maximum	
ON Current	4.2mA minimum (at 15V DC)		3.2mA minimum (at 15V DC)		—	
OFF Current	1.2mA maximum		0.9mA maximum		—	
Turn ON Time	4ms				25ms	
Turn OFF Time	4ms				30ms	
Isolation	Between input terminals: Not isolated Internal circuit: Photocoupler isolated				Between input terminals in the same common: Not isolated Between input terminals in different commons: Isolated Between input terminals and internal circuits: Photocoupler isolated	
External Load for I/O Interconnection	Not needed				Not needed	
Single Determination Method	Static				Static	
Effect of Improper Input Connection	Both sink and source input signals can be connected. If any input exceeding the rated value is applied, permanent damage may be caused.				If any input exceeding the rated value is applied, permanent damage may be caused.	
Cable Length	3m in compliance with electromagnetic immunity				—	
Connector on Mother Board	MC1.5/10-G-3.81BK (Phoenix Contact)		FL26A2MA (Oki Electric Cable)		MC1.5/10-G-3.81BK (Phoenix Contact)	
Connector Insertion/Removal Durability	100 times minimum					
Applicable Ferrule	1-wire: A1 0.5-8 WH 2-wire: A1-TWIN 2x0.5-8 WH		—		—	
Internal Current Draw	All Inputs ON	25mA (5V DC)	40mA (5V DC)	35mA (5V DC)	65mA (5V DC)	60mA (5V DC), 0mA (24V DC)
	All Inputs OFF	5mA (5V DC)	5mA (5V DC)	5mA (5V DC)	10mA (5V DC)	30mA (5V DC), 0mA (24V DC)
Internal Power Consumption (at 24V DC while all inputs ON)	0.17W		0.27W		0.24W	0.44W
Weight	85g	100g	65g	100g	80g	

Transistor Output Modules

Part Number	FC4A-T08K1 FC4A-T08S1	FC4A-T16K3 FC4A-T16S3	FC4A-T32K3 FC4A-T32S3
Output Points	8 (8/1 common)	16 (16/1 common)	32 (16/1 common)
Output	FC4A-T@K@: Transistor sink output FC4A-T@S@: Transistor source output		
Load Voltage	24V DC		
Operating Load Voltage Range	20.4 to 28.8V DC		
Maximum Load Current	0.3A per point	0.1A per point	
	3A per common	1A per common	
Voltage Drop (ON Voltage)	1V maximum (voltage between COM and output terminals when output is on)		
Inrush Current	1A maximum		
Clamping Voltage	39V±1V		
Maximum Lamp Load	8W		
Inductive Load	L/R = 10ms (28.8V DC)		
External Current Draw	FC4A-T@K@: 100mA maximum, 24V DC (power voltage at the +V terminal) FC4A-T@S@: 100mA maximum, 24V DC (power voltage at the -V terminal)		
Isolation	Between output terminal and internal circuit: Photocoupler isolated Between output terminals: Not isolated		

Part Number	FC4A-T08K1 FC4A-T08S1	FC4A-T16K3 FC4A-T16S3	FC4A-T32K3 FC4A-T32S3	
Connector on Mother Board	MC1.5/10-G-3.81BK (Phoenix Contact)	FL26A2MA (Oki Electric Cable)		
Connector Insertion/Removal Durability	100 times minimum			
Applicable Ferrule	1-wire: A1 0.5-8 WH 2-wire: A1-TWIN 2x0.5-8 WH			
Internal Current Draw	All outputs ON	10mA (5V DC) 20mA (24V DC)	10mA (5V DC) 40mA (24V DC)	20mA (5V DC) 70mA (24V DC)
	All outputs OFF	5mA (5V DC) 0mA (24V DC)	5mA (5V DC) 0mA (24V DC)	10mA (5V DC) 0mA (24V DC)
Internal Power Consumption (at 24V DC while all outputs ON)	0.55W	1.03W	1.82W	
Output Delay	Turn ON Time	300μs maximum		
	Turn OFF Time	300μs maximum		
Weight	85g	70g	105g	

PLCs

Operator Interfaces

Automation Software

Power Supplies

Sensors

Communication & Networking

**Relay Output Module Specifications**

Part Number		FC4A-R081	FC4A-R161
Output Points		8 (4/1 common)	16 (8/1 common)
Output		1NO (form A)	
Maximum Load Current		2A per point	
		7A per common	8A per common
Minimum Switching Load		0.1mA/0.1V DC (reference value)	
Initial Contact Resistance		30mΩ maximum	
Electrical Life		100,000 operations minimum (rated load 1,800 operations/hour)	
Mechanical Life		20,000,000 operations minimum (no load 1,8000 operations/hour)	
Rated Load		240V AC/2A (resistive load, inductive load cos φ = 0.4) 30V DC/2A (resistive load, inductive load L/R = 7ms)	
Dielectric Strength		Between output and ⊕ or ⊖ terminals: 1,500V AC 1 minute Between output terminal and internal circuit: 1,500V AC, 1 minute Between output terminals (COMs): 1,500V AC, 1 minute	
Connector On Mother Board		MC1.5/11-G-3.81BK (Phoenix Contact)	MC1.5/10-G-3.81BK (Phoenix Contact)
Connector Insertion/ Removal Durability		100 times minimum	
Applicable Ferrule		1-wire: A1 0.5-8 WH 2-wire: A1-TWIN 2×0.5-8 WH	
Internal Current Draw	All outputs ON	30mA (5V DC) 40mA (24V DC)	45mA (5V DC) 75mA (24V DC)
	All outputs OFF	5mA (5V DC) 0mA (24V DC)	5mA (5V DC) 0mA (24V DC)
Internal Power Consumption (at 24V DC while all outputs ON)		1.16W	2.10W
Weight		110g	145g

**Combination I/O Module Specifications**

Part Number		FC4A-M08BR1	FC4A-M24BR2
Input Points		4 (4/1 common)	16 (16/1 common)
Input Voltage		24V DC sink/source input signal	
Input Voltage Range		20.4 to 28.8V DC	
Input Current		7mA/point (24V DC)	
Input Impedance		3.4kΩ	
ON Voltage		15V minimum	
OFF Voltage		5V maximum	
ON Current		4.2mA minimum (at 15V DC)	
OFF Current		1.2mA maximum	
Turn ON Time		4ms (24V DC)	
Turn OFF Time		4ms (24V DC)	
Isolation		Between input terminals: Not isolated Internal circuit: Photocoupler isolated	
External Load for I/O Interconnection		Not needed	
Signal Determination Method		Static	
Effect of Improper Input Connection		Both sinking and sourcing input signals can be connected. If any input exceeding the rated value is applied, permanent damage may be caused.	
Cable Length		3m in compliance with electromagnetic immunity	



Part Number		FC4A-M08BR1	FC4A-M24BR2
Output Specifications	Output Points	4 (4/1 common)	8 (4/1 common)
	Output	1NO (form A)	
	Maximum Load Current	2A per point 7A per common	
	Minimum Switching Load	0.1mA/0.1V DC (reference value)	
	Initial Contact Resistance	30 mΩ maximum	
	Electrical Life	100,000 operations minimum (rated load 1,800 operations/hour)	
	Mechanical Life	20,000,000 operations minimum (no load 18,000 operations/hour)	
	Rated Load	240V AC/2A (resistive load, inductive load cos φ = 0.4) 30V DC/2A (resistive load, inductive load L/R = 7ms)	
	Dielectric Strength	Between output and ⊕ or ⊖ terminals: 1,500V AC, 1 minute Between output terminal and internal circuit: 1,500V AC, 1 minute Between output terminals (COMs): 1,500V AC, 1 minute	
Connector on Mother Board		MC1.5/11-G-3.81BK (Phoenix Contact)	Input: F6018-17P (Fujicon) Output: F6018-11P (Fujicon)
Connector Insertion/Removal Durability		100 times minimum	Not removable
Internal Current Draw	All I/Os ON	25mA (5V DC), 20mA (24V DC)	65mA (5V DC), 45mA (24V DC)
	All I/Os OFF	5mA (5V DC), 0mA (24V DC)	10mA (5V DC), 0mA (24V DC)
Internal Power Consumption (at 24V DC while all I/Os are ON)		0.65W	1.52W
Weight		95g	140g

Input Usage Limits

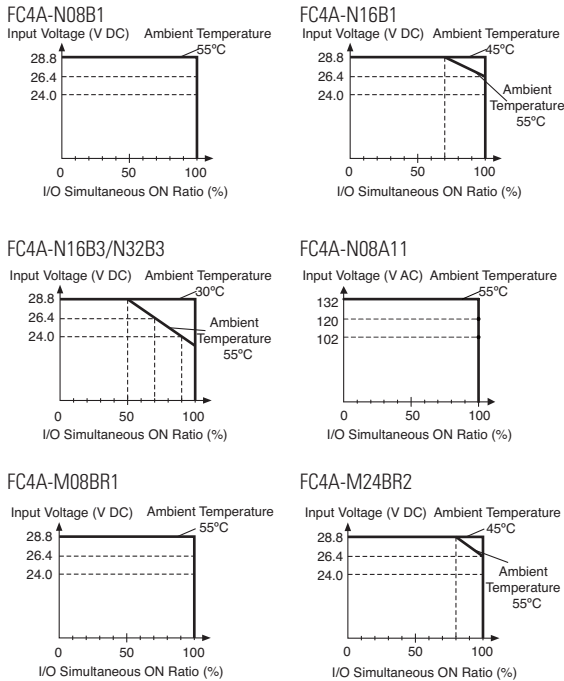

When using at an operating ambient temperature above 40°C, reduce the input voltage or the quantity of I/O points that turn on simultaneously.

Input Internal Circuit

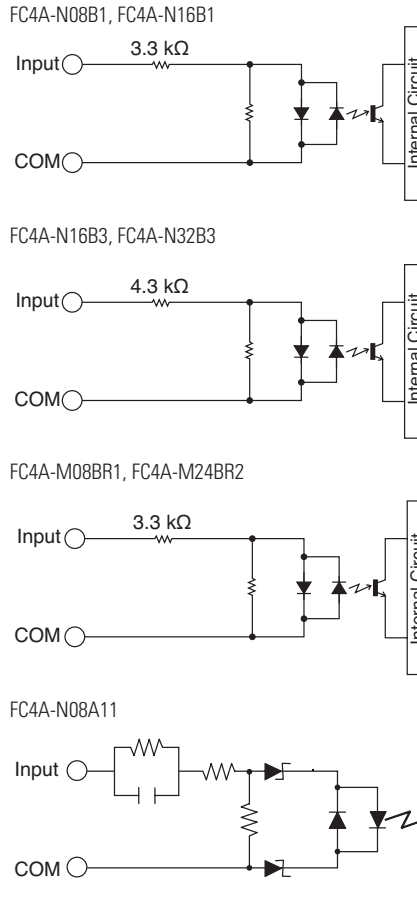

Output Internal Circuit

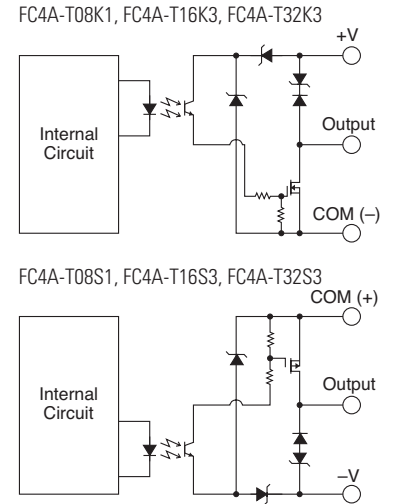

### Analog I/O Modules Specifications

#### Analog I/O Module Specifications

Part Number	FC4A-L03A1	FC4A-L03AP1	FC4A-J2A1	FC4A-K1A1
Input Points	2	2	2	—
Input Signal	Voltage input (0 to 10V DC) Current input (4 to 20mA)	Thermocouple Resistance thermometer	Voltage input (0 to 10V DC) Current input (4 to 20mA)	—
Output Points	1	1	—	1
Output Signal	Voltage output (0 to 10V DC) Current output (4 to 20mA)	Voltage output (0 to 10V DC) Current output (4 to 20mA)	—	Voltage output (0 to 10V DC) Current output (4 to 20mA)
Power Voltage	24V DC			
Allowable Voltage Range	20.4 to 28.8V DC			
External Current Draw *	45mA (24V DC)	40mA (24V DC)	35mA (24V DC)	40mA (24V DC)
Connector on Mother Board	MC1.5/11-G-3.81BK (Phoenix Contact)			
Connector Insertion/Removal Durability	100 times minimum			
Applicable Ferrule	1 terminal: A1 0.5-8 WH, 2 terminals: A1-TWIN 2x0.5-8 WH			
Internal Current Draw	50mA (5V DC)			
Internal Power Consumption	0.34W (at 24V DC while all I/Os are ON)			
Weight	85g			

Input Circuit

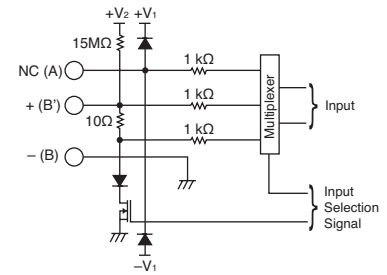

Output Circuit

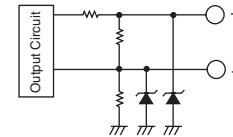

Part Number	FC4A-J4CN1	FC4A-J8C1	FC4A-J8AT1	FC4A-K2C1
I/O Points	4 inputs	8 inputs	8 inputs	2 outputs
Power Voltage	24V DC			
Allowable Voltage Range	20.4 to 28.8V DC			
Connector on Mother Board	MC1.5/11-G-3.81BK (Phoenix Contact)			
Connector Insertion/Removal Durability	100 times minimum			
Internal Current Draw	5V DC	30mA	30mA	30mA
	24V DC	0mA		
External Current Draw *	50mA (24V DC)	40mA (24V DC)	25mA (24V DC)	75mA (24V DC)
Weight	140g	140g	125g	110g



\* The external current draw is the value when all the analog inputs are used and the analog output value is at 100%.

PLCs

Operator Interfaces

Automation Software

Power Supplies

Sensors

Communication &amp; Networking

Analog Input Specifications (1)

Part Number		FC4A-L03A1, FC4A-J2A1		FC4A-L03AP1	
Input Signal		Voltage Input 0 to 10V	Current Input 4 to 20mA	Thermocouple Type K (0 to 1300°C) Type J (0 to 1200°C) Type T (0 to 400°C)	Resistance Thermometer Pt100 3-wire type (-100 to 500°C)
Input Impedance		1 MΩ minimum	10Ω	1 MΩ minimum	1 MΩ minimum
Allowable Conductor Resistance (per wire)		—	—	—	200Ω maximum
Input Detection Current		—	—	—	1.0mA maximum
Sampling Duration Time		20ms maximum		20ms maximum	
Sampling Repetition Time		20ms maximum		20ms maximum	
Total Input System Transfer Time		105ms + 1 scan time		200ms + 1 scan time	
Input		Single-ended	Differential		
Operating Mode		Self-scan			
Conversion Method		Σ Δ type ADC			
Input Error	Maximum Error at 25°C	±0.2% of full scale		±0.2% of full scale plus reference junction compensation accuracy (±4°C maximum)	±0.2% of full scale
	Temperature Coefficient	±0.006% of full scale /°C			
	Repeatability after Stabilization Time	±0.5% of full scale			
	Non-linearity	±0.2% of full scale			
	Maximum Error	±1% of full scale			
Digital Resolution		4096 increments (12 bits)			
Output Value of LSB		2.5mV	4μA	Type K: 0.325°C Type J: 0.300°C Type T: 0.100°C	0.15°C
Data Type in Application Program		Default: Optional:		0 to 4095 (12-bit data) -32768 to 32767 (optional range designation) <sup>1</sup>	
Monotonicity		Yes			
Input Data Out of Range		Detectable <sup>2</sup>			
Noise Resistance	Maximum Temporary Deviation during Electrical Noise Tests	±3% maximum when a 500V clamp voltage is applied to the power and I/O wiring			Accuracy is not assured when noise is applied.
	Input Filter	No			
	Cable	Twisted pair shielded cable is recommended for improved noise immunity		—	
	Crosstalk	2 LSB maximum			
Dielectric Strength		500V (between input and power circuit)			
Type of Protection		Photocoupler-isolated (between input and internal circuit)			
Effect of Improper Input Connection		No damage			
Maximum Permanent Allowed Overload (No Damage)		13V DC	40mA	—	
Selection of Analog Input Signal		Using software programming			
Calibration or Verification to Maintain Rated Accuracy		N/A			

1: The 12-bit data (0 to 4095) processed in the analog I/O module can be linear-converted to a value between -32768 and 32767. The optional range designation, and analog I/O data minimum and maximum values can be selected using data registers allocated to analog I/O modules.  
 2: When an error is detected, a corresponding error code is stored to a data register allocated to analog I/O operating status.

**Analog Input Specifications (2)**

Part Number	FC4A-J4CN1, FC4A-J8C1		FC4A-J4CN1		FC4A-J8AT1		
Input Signal	Voltage Input	Current Input	Thermocouple	Resistance Thermometer	NTC Thermistor	PTC Thermistor	
Input Range	0 to 10V	4 to 20mA	Type K (0 to 1300°C) Type J (0 to 1200°C) Type T (0 to 400°C)	Pt100, Pt1000 3-wire type (–100 to 500°C) Ni100, Ni1000 3-wire type (–60 to 180°C)	–50 to +150°C		
Input Impedance	1 MΩ minimum	12 Ω (FC4A-J4CN1) 100Ω (FC4A-J8C1)	0.9 MΩ minimum	—	—		
Input Detection Current	—	—	—	0.1mA	0.1mA		
Sampling Duration Time	FC4A-J4CN1: 5ms maximum		FC4A-J8C1: 1ms maximum		1ms maximum		
Sampling Repetition Time	FC4A-J4CN1: 5ms maximum		FC4A-J8C1: 1ms maximum		10ms × channels		
Total Input System Transfer Time	FC4A-J4CN1: 40ms/ch + 1 scan time		FC4A-J8C1: 6ms/ch + 1 scan time		10ms/ch + 1 scan time		
Input	Single-ended input						
Operating Mode	Self-scan						
Conversion Method	Σ Δ type ADC (FC4A-J4CN1), Successive approximation register method (FC4A-J8C1, FC4A-J8AT1)						
Input Error	Maximum Error at 25°C	—		±0.005% of full scale /°C			
	Plus Reference Junction Compensation Accuracy	—	—	—	±2°C maximum		
	Temperature Coefficient	±0.005% of full scale/°C					
	Repeatability after Stabilization Time	±0.5% of full scale				±0.5% of full scale /°C	
	Non-linearity	±0.04% of full scale				Non-linear	
	Maximum Error	±1% of full scale				±1% of full scale	
Digital Resolution	50000 increments (16 bits)		Type K: Approx. 24000 increments (15 bits) Type J: Approx. 33000 increments (15 bits) Type T: Approx. 10000 increments (14 bits)	Pt100: Approx. 6400 increments (13 bits) Pt1000: Approx. 64000 increments (16 bits) Ni100: Approx. 4700 increments (13 bits) Ni1000: Approx. 47000 increments (16 bits)	Approx. 4000 increments (12 bits)		
Output Value of LSB	0.2mV	0.32μA	Type K: 0.058°C Type J: 0.038°C Type T: 0.042°C	Pt100: 0.086°C Pt1000: 0.0086°C Ni100: 0.037°C Ni1000: 0.0037°C	30Ω		
Data Type in Application Program	Default: 0 to 50000 Optional: –32768 to 32767 (optional range designation) <sup>2</sup>				Default: 0 to 4000 Optional: –32768 to 32767 (optional range designation) <sup>1</sup>		
	—		Temperature: °C, °F		Temperature: C, °F	—	
Monotonicity	Yes						
Input Data Out of Range	Detectable						
Noise Resistance	Maximum Temporary Deviation during Electrical Noise Tests	Accuracy is not assured when noise is applied.					
	Input Filter	Software selectable					
	Cable	Twisted pair shielded cable is recommended for improved noise immunity		—		Twisted pair shielded cable is recommended for improved noise immunity	
	Crosstalk	2 LSB maximum					
Isolation	Between input and power circuit: Isolated Between input and internal circuit: Photocoupler-isolated						

Effect of Improper Input Connection	No damage			
Maximum Permanent Allowed Overload (No Damage)	11V DC	22mA DC	—	—
Selection of Analog Input Signal	Using software programming			
Calibration or Verification to Maintain Rated Accuracy	N/A			

- 1: The 16-bit data (0 to 50000) processed in the analog I/O module can be linear-converted to a value between -32768 and 32767. The optional range designation, and analog I/O data minimum and maximum values can be selected using data registers allocated to analog I/O modules.
- 2: When an error is detected, a corresponding error code is stored to a data register allocated to analog I/O operating status.

**Analog Output Specifications**

Part Number	FC4A-L03A1	FC4A-L03AP1	FC4A-K1A1	FC4A-K2C1
Output Voltage	0 to 10V DC			-10 to +10V DC
Output Range	4 to 20mA			
Load Impedance	Voltage Output: 2kΩ minimum Current Output: 300kΩ maximum			
Load	Resistive load			
Settling Time	50ms	130ms	50ms	1ms/ch
Total Output Transfer Time	50ms + 1 scan time	130ms + 1 scan time	50ms + 1 scan time	1ms × channels+ 1 scan time
Output Error	Maximum Error at 25× C	±0.2% of full scale		
	Temperature Coefficient	±0.015% of full scale/°C		
	Repeatability after Stabilization Time	±0.5% of full scale		
	Output Voltage Drop	±1% of full scale		
	Non-linearity	±0.2% of full scale		
	Output Ripple	1 LSB maximum		
	Overshoot	0%		
	Total Error	±1% of full scale		
Digital Resolution	4096 increments (12 bits)			50000 increments (16 bits)
Output Value of LSB	Voltage	2.5mV		0.4mV
	Current	4μA		0.32μA
Data Type in Application Program	Default: 0 to 4095 (standard)			-25000 to 25000 (voltage)
	Optional: -32768 to 32767 (optional range designation) <sup>1</sup>			
Monotonicity	Yes			
Current Loop Open	Undetectable			
Noise Resistance	Maximum Temporary Deviation during Electrical Noise Tests	±3% maximum when a 500V clamp voltage is applied to the power and I/O wiring		Not assured
	Cable	Twisted pair shielded cable is recommended for improved noise immunity		Twisted pair cable
	Crosstalk	None		2 LSB maximum
Isolation	Between output and power circuit	500V		Isolated
	Between output and internal circuit	Photocoupler-isolated		
Effect of Improper Output Connection	No damage			
Selection of Analog Output Signal	Using software programming			
Calibration or Verification to Maintain Rated Accuracy	N/A			

- 1: The 12-bit data (0 to 4095) processed in the analog I/O module can be linear-converted to a value between -32768 and 32767. The optional range designation, and analog I/O data minimum and maximum values can be selected using data registers allocated to analog I/O modules.

PLCs

Operator Interfaces

Automation Software

Power Supplies

Sensors

Communication & Networking

**Expansion Interface Module Specifications**

Part Number	FC5A-EXM1M (Expansion Interface Master Module)	FC5A-EXM1S (Expansion Interface Slave Module)	FC5A-EXM2 (Expansion Interface Module)
Rated Power Voltage	—	24V DC (supplied from external power)	24V DC (supplied from external power)
Allowable Voltage Range	—	20.4 to 26.4V DC (including ripple)	20.4 to 26.4V DC (including ripple)
Current Draw	Internal power (supplied from CPU module): 90mA (5V DC) 0mA (24V DC)	Internal power (supplied from CPU module): 0mA (5V DC) 0mA (24V DC) External power: With I/O modules 750mA (26.4V DC) <sup>1</sup>	Internal power (supplied from CPU module): 50mA (5V DC) 0mA (24V DC) External power: With I/O modules 750mA (26.4V DC) <sup>1</sup>
Maximum Power Consumption (External Power) <sup>1</sup>	—	19W (26.4V DC)	19W (26.4V DC)
Allowable Momentary Power Interruption	—	10ms minimum (24V DC)	10ms minimum (24V DC)
I/O Expansion	Between CPU module and expansion interface module Connectable CPU modules: FC5A-D16RK1/D16RS1/D32K3/D32S3 Connectable I/O modules: 7 maximum Beyond the expansion interface module Connectable I/O modules: 8 digital I/O modules maximum (AC input modules are not applicable) <sup>2</sup>		
I/O Refresh Time <sup>3</sup>	3.6ms		2.8ms
Communication between CPU Module and Expansion Interface Module	Asynchronous communication (I/O refresh of I/O modules on both sides of the expansion interface module is asynchronous.)		
Isolation from Internal Circuit	Only communication interface part is isolated		Not isolated
EMC Compliant Cable Length	1m (FC5A-KX1C)		—
Power Supply Connector	Connector on Mother Board	—	MKDSN1.5/3-5.08-BK (Phoenix Contact)
	Connector Insertion/Removal Durability	—	100 times minimum
Expansion Cable Connector	Connector on Mother Board	FCN-365P024-AU (Fujitsu Component)	
	Connector Insertion/Removal Durability	100 times minimum	
Weight	70g	135g	140g

- 1: Power consumption by the expansion interface module and eight I/O modules.  
 2: The maximum number of relay outputs that can be turned on simultaneously is 54 points.  
 3: Maximum I/O refresh time of the expansion interface module. D8252 stores the refresh time.

PLCs

Operator Interfaces

Automation Software

Power Supplies

Sensors

Communication &amp; Networking

## Instructions

### Basic Instructions

Symbol	Function	Qty of Bytes	
		FC5A-D16RK1, -D16RS1 FC5A-D32K3, -D32S3	Others
AND	Series connection of NO contact	4	4
AND LOD	Series connection of circuit blocks	4	5
ANDN	Series connection of NC contact	4	4
BPP	Restores the result of bit logical operation which was saved temporarily	4	2
BPS	Saves the result of bit logical operation temporarily	4	5
BRD	Reads the result of bit logical operation which was saved temporarily	4	3
CC=	Equal to comparison of counter current value	10	7
CC≥	Greater than or equal to comparison of counter current value	10	7
CDP	Dual pulse reversible counter (0 to 65535)	12	4
CNT	Adding counter (0 to 65535)	12	4
CUD	Up/down selection reversible counter (0 to 65535)	12	4
DC=	Equal to comparison of data register value	10	8
DC≥	Greater than or equal to comparison of data register value	10	8
END	Ends a program	4	2
JEND	Ends a jump instruction	4	4
JMP	Jumps a designated program area	6	4
LOD	Stores intermediate results and reads contact status	4	6
LODN	Stores intermediate results and reads inverted contact status	4	6
MCR	Ends a master control	4	4
MCS	Starts a master control	4	4
OR	Parallel connection of NO contact	4	4
OR LOD	Parallel connection of circuit blocks	4	5
ORN	Parallel connection of NC contact	4	4
OUT	Outputs the result of bit logical operation	4	6
OUTN	Output the inverted result of bit logical operation	4	6
RST	Resets output, internal relay, or shift register bit	4	6
SET	Sets output, internal relay, or shift register bit	4	6
SFR	Forward shift register	10	6
SFRN	Reverse shift register	10	6
SOTD	Falling-edge differentiation output	4	5
SOTU	Rising-edge differentiation output	4	5
TIM	Subtracting 100-ms timer (0 to 6553.5 sec)	12	4
TMH	Subtracting 10-ms timer (0 to 655.35 sec)	12	4
TML	Subtracting 1-sec timer (0 to 65535 sec)	12	4
TMS	Subtracting 1-ms timer (0 to 65.535 sec)	12	4

PLCs

Operator Interfaces

Automation Software

Power Supplies

Sensors

Communication & Networking

**Advanced Instructions**

PLCs	Symbol	Function	Slim		All-in-One		
			—	FC5A -D16RK1, -D16RS1, -D32K3, -D32S3	FC5A -C10R2, C10R2C	FC5A -C16R2, C16R2C	FC5A -C24R2, C24R2C
			FC4A -D20K3, -D20S3	FC4A -D20RK1, -D20RS1, -D40K3, -D40S3	FC4A -C10R2, -C10R2C	FC4A -C16R2, -C16R2C	FC4A -C24R2, -C24R2C
Operator Interfaces	NOP	No Operation	×	×	×	×	×
	MOV	Move	×	×	×	×	×
	MOVN	Move Not	×	×	×	×	×
	IMOV	Indirect Move	×	×	×	×	×
	IMOVN	Indirect Move Not	×	×	×	×	×
	BMOV	Block Move	—	×	*	*	*
	IBMV	Indirect Bit Move	—	×	*	*	*
	IBMVN	Indirect Bit Move Not	—	×	*	*	*
	CMP=	Compare Equal To	×	×	×	×	×
	CMP<>	Compare Unequal To	×	×	×	×	×
Automation Software	CMP<	Compare Less Than	×	×	×	×	×
	CMP>	Compare Greater Than	×	×	×	×	×
	CMP<=	Compare Less Than or Equal To	×	×	×	×	×
	CMP>=	Compare Greater Than or Equal To	×	×	×	×	×
	ICMP>=	Interval Compare Greater Than or Equal to	—	×	*	*	*
	ADD	Addition	×	×	×	×	×
	SUB	Subtraction	×	×	×	×	×
	MUL	Multiplication	×	×	×	×	×
	DIV	Division	×	×	×	×	×
	ROOT	Root	×	×	×	×	×
Power Supplies	ANDW	AND Word	×	×	×	×	×
	ORW	OR Word	×	×	×	×	×
	XORW	Exclusive OR Word	×	×	×	×	×
	SFTL	Shift Left	×	×	×	×	×
	SFTR	Shift Right	×	×	×	×	×
	•BCDLS	•BCD Left Shift	—	×	*	*	*
	WSFT	Word Shift	—	×	*	*	*
	ROTL	Rotate Left	×	×	×	×	×
	ROTR	Rotate Right	×	×	×	×	×
	HTOB	Hex to BCD	×	×	×	×	×
Sensors	BTOH	BCD to Hex	×	×	×	×	×
	HTOA	Hex to ASCII	×	×	×	×	×
	ATOH	ASCII to Hex	×	×	×	×	×
	BTOA	BCD to ASCII	×	×	×	×	×
	ATOB	ASCII to BCD	×	×	×	×	×
	ENCO	Encode	—	×	*	*	*
	DECO	Decode	—	×	*	*	*
	BCNT	Bit Count	—	×	*	*	*
	ALT	Alternate Output	—	×	*	*	*
	CVDT	Convert Data Type	—	*	*	*	*
Communication & Networking	WKTIM	Week Timer	×	×	×	×	×
	WKTBL	Week Table	×	×	×	×	×
	DISP	Display	×	×	—	—	*
	DGRD	Digital Read	×	×	—	—	*
	TXD1	Transmit 1	×	×	×	×	×
	TXD2	Transmit 2	×	×	*	×	×
	RXD1	Receive 1	×	×	×	×	×



Symbol	Function	Slim		All-in-One		
		—	FC5A -D16RK1, -D16RS1, -D32K3, -D32S3	FC5A -C10R2, C10R2C	FC5A -C16R2, C16R2C	FC5A -C24R2, C24R2C
		FC4A -D20K3, -D20S3	FC4A -D20RK1, -D20RS1, -D40K3, -D40S3	FC4A -C10R2, -C10R2C	FC4A -C16R2, -C16R2C	FC4A -C24R2, -C24R2C
RXD2	Receive 2	x	x	*	x	x
LABEL	Label	x	x	x	x	x
LJMP	Label Jump	x	x	x	x	x
LCAL	Label Call	x	x	x	x	x
LRET	Label Return	x	x	x	x	x
IOREF	I/O Refresh	x	x	x	x	x
HSCRFB	High-speed Counter Refresh	—	*	*	*	*
FRQRF	Frequency Measurement Refresh	—	*	*	*	*
DI	Disable Interrupt	—	x	*	*	*
EI	Enable Interrupt	—	x	*	*	*
XYFS	XY Format Set	x	x	*	*	x
CVXTY	Convert X to Y	x	x	*	*	x
CVYTX	Convert Y to X	x	x	*	*	x
AVRG	Average	—	*	*	*	*
PULS1	Pulse Output 1	x	x	—	—	—
PULS2	Pulse Output 2	x	x	—	—	—
PULS3	Pulse Output 3	—	°	—	—	—
PWM1	Pulse Width Modulation 1	x	x	—	—	—
PWM2	Pulse Width Modulation 2	x	x	—	—	—
PWM3	Pulse Width Modulation 3	—	°	—	—	—
RAMP1	Ramp Pulse Output 1	x	x	—	—	—
RAMP2	Ramp Pulse Output 2	—	°	—	—	—
ZRN1	Zero Return 1	—	x	—	—	—
ZRN2	Zero Return 2	—	x	—	—	—
ZRN3	Zero Return 3	—	°	—	—	—
PID	PID Control	x	x	—	—	x
DTML	1-sec Dual Timer	—	x	*	*	*
DTIM	100-ms Dual Timer	—	x	*	*	*
DTMH	10-ms Dual Timer	—	x	*	*	*
DTMS	1-ms Dual Timer	—	x	*	*	*
TTIM	Teaching Timer	—	x	*	*	*
RUNA	Run Access	—	x	—	—	*
STPA	Stop Access	—	x	—	—	*
RAD	Degree to Radian	—	*	*	*	*
DEG	Radian to Degree	—	*	*	*	*
SIN	Sine	—	*	*	*	*
COS	Cosine	—	*	*	*	*
TAN	Tangent	—	*	*	*	*
ASIN	Arc Sine	—	*	*	*	*
ACOS	Arc Cosine	—	*	*	*	*
ATAN	Arc Tangent	—	*	*	*	*
LOGE	Natural Logarithm	—	*	*	*	*
LOG10	Common Logarithm	—	*	*	*	*
EXP	Exponent	—	*	*	*	*
POW	Power	—	*	*	*	*

x: Available \* : Not available on the FC4A ° : Available on the FC5A-D32K3 and FC5A-D32S3 only

PLCs

Operator Interfaces

Automation Software

Power Supplies

Sensors

Communication & Networking

Dimensions (mm)

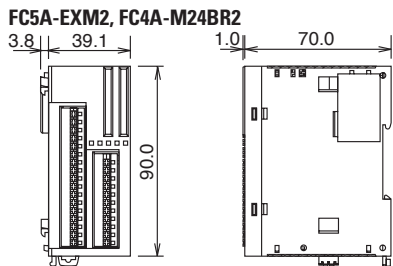
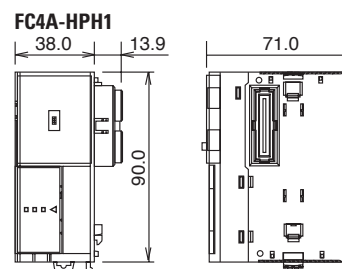
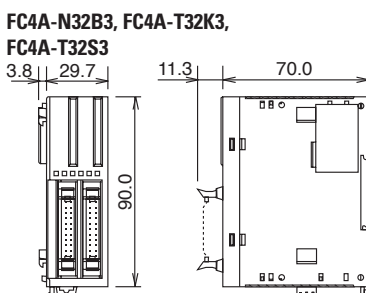
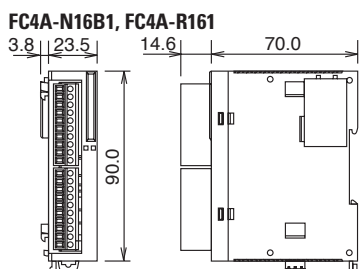
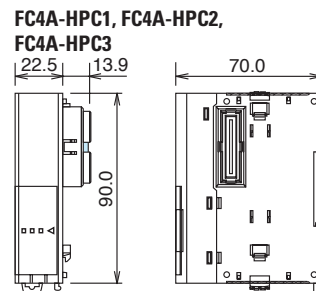
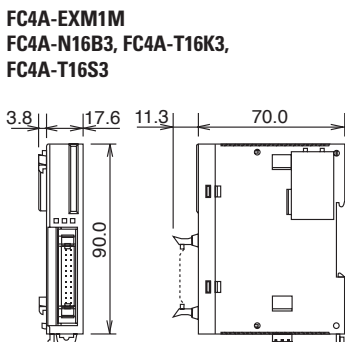
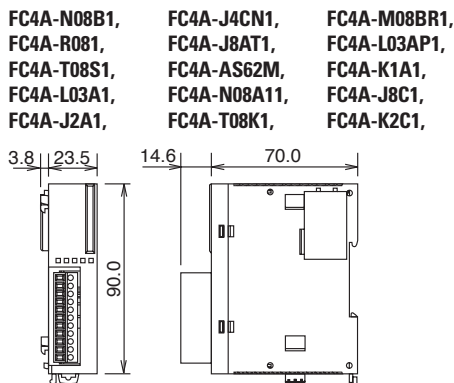
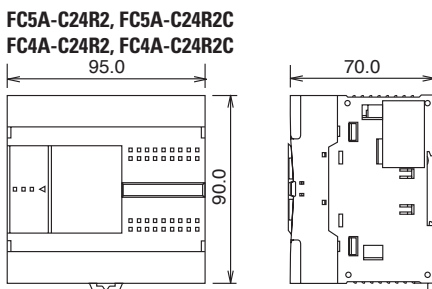
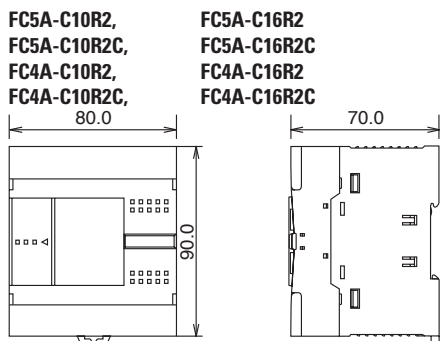
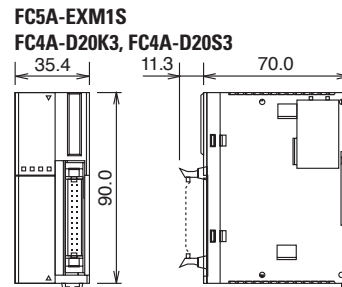
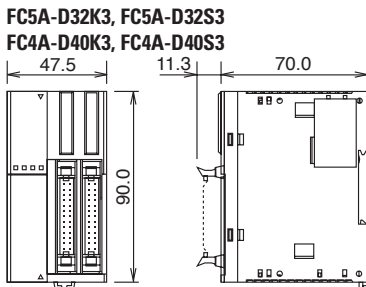
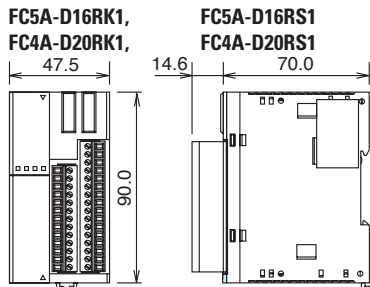

Example

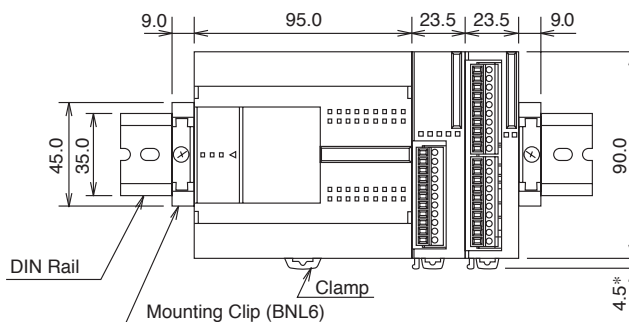

The figure illustrates a system setup consisting of the all-in-one 24-I/O CPU module, an 8-point relay output module, and a 16-point DC input module mounted on a 35-mm-wide-DIN rail using BNL6 mounting clips.

Mounting Hole Layout (mm)

FC5A-C10R2, FC5A-C16R2  
 FC5A-C10R2C, FC5A-C16R2C  
 FC4A-C10R2, FC4A-C16R2  
 FC4A-C10R2C, FC4A-C16R2C

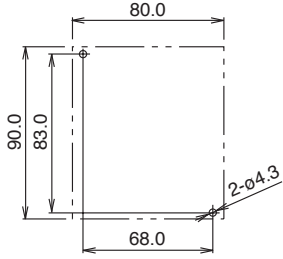

FC4A-N08A11, FC4A-R081  
 FC4A-R161, FC4A-T08K1  
 FC4A-T08S1, FC4A-M08BR1  
 FC4A-L03A1, FC4A-L03AP1  
 FC4A-J2A1, FC4A-K1A1  
 FC4A-J4CN1, FC4A-T8C1  
 FC4A-J8AT1, FC4A-K2C1

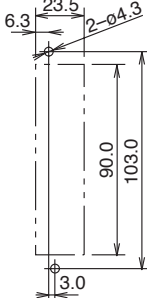

FC5A-EXM2  
 FC4A-M24BR2

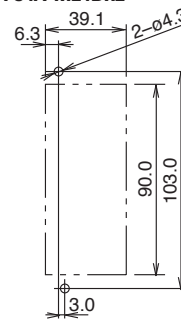

FC5A-EXM1S, FC4A-D20K3  
 FC4A-D20S3

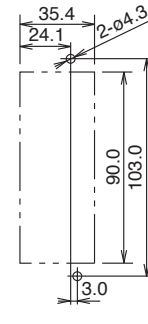

FC5A-C24R2, FC4A-C24R2C  
 FC4A-C24R2, FC4A-C24R2C

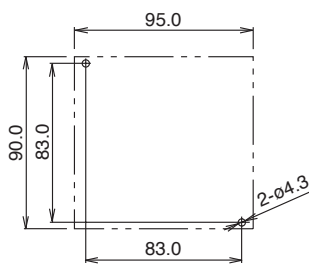

FC5A-EXM1M  
 FC4A-N16B3, FC4A-T16K3,  
 FC4A-T16S3

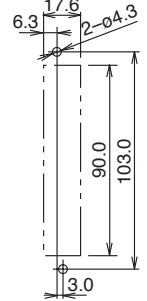

FC4A-HPC1 FC4A-HPC2  
 FC4A-HPC3

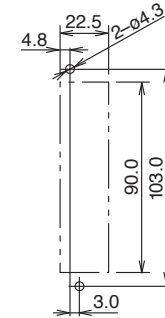

FC4A-N32B3, FC4A-T32K3,  
 FC4A-T32S3

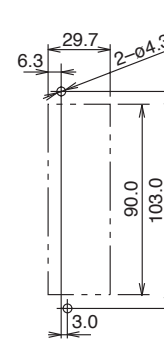

FC5A-D16RK1, FC5A-D16RS1  
 FC5A-D32K3, FC5A-D32S3  
 FC4A-D20RK1, FC4A-D20RS1  
 FC4A-D40K3, FC4A-D40S3

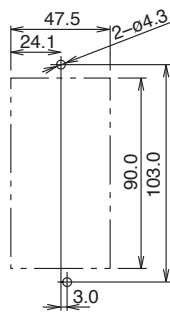

FC4A-HPH1

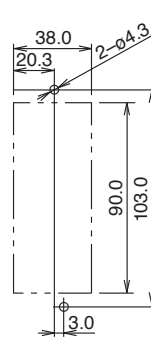

FC4A-HPH1

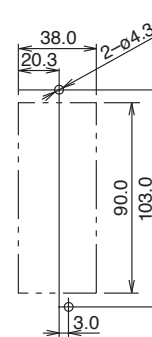

Examples

Mounting hole layout for FC5A-C24R2 or FC4A-C24R2 and four 23.5mm-wide I/O modules

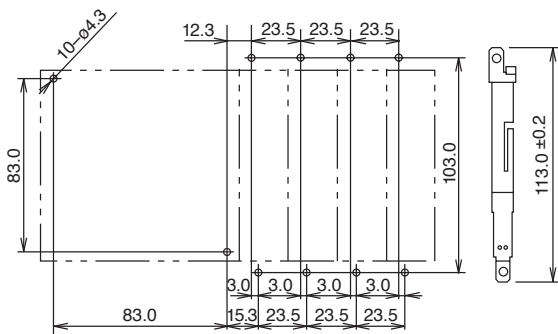

Mounting hole layout from left, FC4A-HPH1, FC4A-D20K3, FC4A-N16B3, FC4A-N32B3, and FC4A-M24BR2 modules

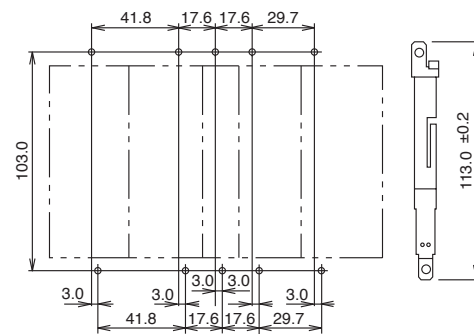

## Web Server

### General Specifications

<b>Rated Power Voltage</b>	24V DC
<b>Allowable Voltage Range</b>	20.4 to 26.4V DC
<b>Current Draw</b>	70 mA
<b>Allowable Momentary Power Interruption</b>	10 ms maximum
<b>Dielectric Strength</b>	500V AC, 1 minute
<b>Insulation Resistance</b>	10 MΩ minimum (500V DC megger)
<b>Noise Resistance</b>	DC power terminal: 1.0 kV, 50 ns to 1 μs Ethernet cable: 0.5 kV, 50 ns to 1 μs (coupling clamp)
<b>Inrush Current</b>	4A maximum
<b>Operating Temperature</b>	0 to 55°C
<b>Storage Temperature</b>	-40 to +70°C (no freezing)
<b>Relative Humidity</b>	10 to 95% (no condensation)
<b>Pollution Degree</b>	2 (IEC 60664-1)
<b>Corrosion Immunity</b>	Free from corrosive gases
<b>Degree of Protection</b>	IP20 (IEC60529)
<b>Vibration Resistance</b>	When mounted on a DIN rail: 5 to 9 Hz amplitude 3.5 mm 9 to 150 Hz acceleration 9.8 m/s <sup>2</sup> (1G) 2 hours in each of 3 axes
<b>Shock Resistance</b>	147 m/s <sup>2</sup> (15G), 11 ms duration 3 shocks each in 3 axes
<b>Weight (approx.)</b>	150g

### Interface Specifications

<b>Communication</b>	RS232C <=> Ethernet conversion function
<b>Ethernet Specifications</b>	Electrical characteristics: Complies with IEEE802.3 Transmission speed: 10BASE-T/100BASE-TX (Not CE compliant) Communication protocol: IP/ICMP/ARP Ethernet protocol: TCP/SMTP/HTTP/Telnet No. of TCP connections: 1
<b>Serial Interface Specifications</b>	Electrical characteristics: EIA RS232C Transmission speed: 9600 to 115200 bps Synchronization: Asynchronous Communication protocol: Full duplex Transmission control: RTS/CTS, XON/OFF, None
<b>Connection Method</b>	Ethernet interface: RJ45 Serial interface: Mini DIN 8-pin connector Cable Part No.: FC4A-KC3C
<b>Major Functions</b>	Remote maintenance: Uploading, downloading and monitoring using WindLDR via Ethernet  Web server: Configure the web server unit using Internet Explorer etc. Reading and writing PLC operands using Java applet. Web file area: 512 KB Compliant browser: Internet Explorer 6.0 or higher, Netscape Navigator 7.2  Ethernet user communication: User communication using Ethernet Message transmission: Registered outgoing message 32 message types, 63 characters maximum per message, 2 email addresses, 64 address characters maximum
<b>Optional</b>	Utility CD: Configuration file, PLC operand monitor sample programs, sample program configuration instructions, instruction manual (English/German/Spanish/Japanese/Chinese)

### Connectable Devices

#### Programmable Controllers

IDEC FC5A MicroSmart  
IDEC FC4A MicroSmart  
IDEC FC3A OpenNet Controller

#### Operator Interface

(RS232C communication with PLC through Ethernet)  
IDEC HG2F

### Dimensions

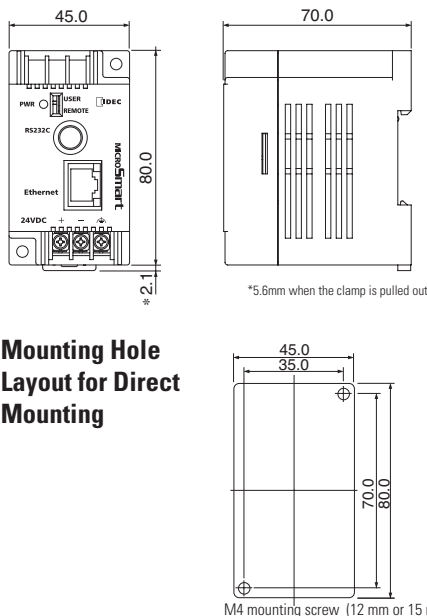

### Web Server Cable (FC4A-KC3C, Cable Length: 100 mm)

#### Cable Dimensions



#### Connector Pinout

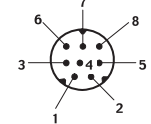

#### Cable Connection Diagram

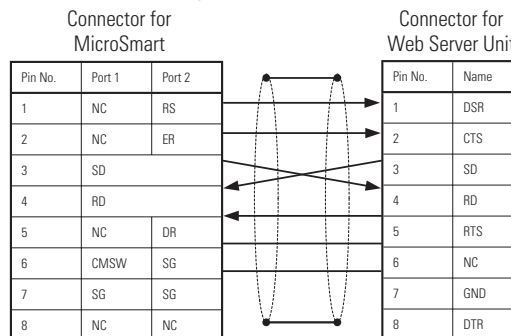

Ethernet is a registered trademark of Xerox Corporation.