

ZE, Z00 Overload Relays

4/2



Z1, Z4 Overload Relays
ZW7 Current Transformer-Operated Overload Relays
Z5 Overload Relays

4/3

4/4



ZWA Electronic Overload Relays
Current Transformers

4/5



Accessories
EMT 6 Thermistor Overload Relay

4/7

4/8



Technical Data

4/11





Dimensions

4/14





Overload Relays With single phasing sensitivity

UL / CSA / IEC / CE

1	2	3	4	5	6
	For direct mounting on contactors (see section 3 for contactors)	Adjustable setting range (Motor full load current)	Type	Price	Short-circuit protection by fuses by circuit breaker
	Contactor size	Amps		\$	Amps Amps
	E(E)M¹⁾	0.1 – 0.16	ZE-0.16	See Price List	1 15
		0.16 – 0.24	ZE-0.24	See Price List	1 15
		0.24 – 0.4	ZE-0.4	See Price List	1 15
		0.4 – 0.6	ZE-0.6	See Price List	1 15
		0.6 – 1.0	ZE-1.0	See Price List	3 15
		1.0 – 1.6	ZE-1.6	See Price List	6 15
		1.6 – 2.4	ZE-2.4	See Price List	6 15
		2.4 – 4	ZE-4	See Price List	15 15
		4 – 6	ZE-6	See Price List	20 15
		6 – 9	ZE-9	See Price List	35 15
		9 – 12	ZE-12³⁾	See Price List	45 –
	00M	0.1 – 0.16	Z00-0.16	See Price List	1 25
		0.16 – 0.24	Z00-0.24	See Price List	1 25
		0.24 – 0.4	Z00-0.4	See Price List	1 25
		0.4 – 0.6	Z00-0.6	See Price List	1 25
		0.6 – 1.0	Z00-1.0	See Price List	3 25
		1.0 – 1.6	Z00-1.6	See Price List	6 25
		1.6 – 2.4	Z00-2.4	See Price List	6 25
		2.4 – 4	Z00-4	See Price List	15 25
		4 – 6	Z00-6	See Price List	20 25
		6 – 10	Z00-10	See Price List	40 25
		10 – 16	Z00-16	See Price List	60 30
		16 – 24	Z00-24	See Price List	90 30





- 1) A distance of at least 5 mm should be maintained between overload relays when mounted side by side.
- 2) Max. 480V AC for type ZE.
- 3) UL / CSA only

UL Listed File No. E 29184
CSA Certified File No. 45958 + 43359

1	2	3	4	5	6	
	For direct mounting on contactors	Setting range	Type	Price	Short-circuit protection by fuses by circuit breaker	
					Maximum 600V AC Maximum 600V AC	
	DIL	Amps		\$	Amps Amps	
	1M	6-10	Z1-10	See Price List	40	40
	1AM	10-16	Z1-16		60	60
	2M	16-24	Z1-24		90	90
	2M	24-40	Z1-40		125	125
	2AM	40-57	Z1-57		200	150
		50-63	Z1-63		200	150
	For separate mounting	63-75	Z1-75	See Price List	250	200
	As supplied: Z1-75+EZ1					
For assembly with DIL universal contactors (without K terminal block)						
	3-22	50-70 70-100 100-140	Z4-70-CNA/K3 Z4-100-CNA/K3 Z4-140-CNA/K3	See Price List	250	250
					400	400
					500	500
	4-22, 6-22	70-100 100-140 140-180 180-240	Z4-100-CNA Z4-140-CNA Z4-180-CNA Z4-240-CNA	See Price List	400	400
					500	500
					500	500
					700	700
	8(A)-22	180-240	Z4-240-CNA/K8	See Price List	700	700
For separate mounting						
		50-70 70-100 100-140 140-180 180-240	Z4-70/K-NA Z4-100/K-NA Z4-140/K-NA Z4-180/K-NA Z4-240/K-NA	See Price List	250	250
					400	400
					500	500
					500	500
					700	700
Saturating Core Current Transformer Operated Relays for motors having long accelerating times						
	-	42-63	ZW7-63	See Price List	As required by associated contactor. Overload relay is self-protecting.	
	-	60-90	ZW7-90			
	-	85-125	ZW7-125			
	-	110-160	ZW7-160			
	-	160-240	ZW7-240			
	-	190-290	ZW7-290			
	-	270-400	ZW7-400			
-	360-540	ZW7-540	See Price List			

Overload Relays With single phasing sensitivity

UL / CSA / IEC / CE

1	2	3	4	5	6
	For direct mounting on contactors	Setting range	Type	Price	Short-circuit protection by fuses by circuit breaker
	DIL	Amps		\$	Amps Amps
Z 5 Overload Relays, Direct mounting					
	DIL 3M 80	25-35	Z5-35/SK3	See Price List	125
		35-50	Z5-50/SK3	See Price List	225
		50-70	Z5-70/SK3	See Price List	250
		70-100	Z5-100/SK3	See Price List	400 Class J
	DIL 4M 115	35-50	Z5-50/SK4	See Price List	225
		50-70	Z5-70/SK4	See Price List	250
		70-100	Z5-100/SK4	See Price List	400 Class J
		95-125	Z5-125/SK4	See Price List	500 Class J
		120-142	Z5-150/SK4	See Price List	600 Class J
Z 5 Overload Relays, Separate mounting					
	—	25-35	Z5-35/KK3	See Price List	125
		35-50	Z5-50/KK3	See Price List	225
		50-70	Z5-70/KK3	See Price List	250
		70-100	Z5-100/KK3	See Price List	400 Class J
	—	35-50	Z5-50/KK4	See Price List	225
		50-70	Z5-70/KK4	See Price List	250
		70-100	Z5-100/KK4	See Price List	400 Class J
		95-125	Z5-125/KK4	See Price List	500 Class J
		120-150	Z5-150/KK4	See Price List	600 Class J
	DIL M 185 DIL M 225 DIL M 250	50-70	Z5-70/FF250	See Price List	250
		70-100	Z5-100/FF250	See Price List	400 Class J
		95-125	Z5-125/FF250	See Price List	500 Class J
		120-160	Z5-160/FF250	See Price List	600 Class J
		160-220	Z5-220/FF250	See Price List	800 Class J
		200-250	Z5-250/FF250	See Price List	800 Class J

UL Listed File No. E 29184
CSA Certified File No. 12528

1	2	3	4
Setting range Overload release Amps		Type	Price \$
Tripping device with built-in current transformers 1.25-6.3		ZWA-6.3(110–120V 50/60Hz) ZWA-6.3(220–240V 50/60Hz) ZWA-6.3(24V DC)	See Price List See Price List See Price List
6.3-25		ZWA-25(110–120V 50/60Hz) ZWA-25(220–240V 50/60Hz) ZWA-25(24V DC)	See Price List See Price List See Price List
25-100		ZWA-100(110–120V 50/60Hz) ZWA-100(220–240V 50/60Hz) ZWA-100(24V DC)	See Price List See Price List See Price List
50-205		ZWA-205(110–120V 50/60Hz) ZWA-205(220–240V 50/60Hz) ZWA-205(24V DC)	See Price List See Price List See Price List
125-500		ZWA-500(110–120V 50/60Hz) ZWA-500(220–240V 50/60Hz) ZWA-500(24V DC)	See Price List See Price List See Price List
200-820		ZWA-820(110–120V 50/60Hz) ZWA-820(220–240V 50/60Hz) ZWA-820(24V DC)	See Price List See Price List See Price List
Current Transformers for Ground Fault protection			
Fault current Amps	Window opening for load wire		
0.3 A	40 mm (1.57 in.)	SSW40-0.3	See Price List
0.5 A		SSW40-0.5	See Price List
1 A		SSW40-1	See Price List
0.5 A	65 mm (2.55 in.)	SSW65-0.5	See Price List
1 A		SSW65-1	See Price List
0.5 A	120 mm (4.72 in.)	SSW120-0.5	See Price List
1 A		SSW120-1	See Price List

Electronic Overload Relays

Selection of contactor according to starting duty (CLASS)

For normal starting and overload conditions, contactors are selected for "CLASS 10". In order that the contactors are not thermally overloaded during longer tripping times, the maximum rated operational current I_e must be reduced according to the CLASS setting.

$$I_{CLASS 5} = I_{CLASS 10} = I_e \quad I_{CLASS 15} = I_e \times 0.82 \quad I_{CLASS 20} = I_e \times 0.71 \quad I_{CLASS 25} = I_e \times 0.63 \quad I_{CLASS 30} = I_e \times 0.58$$

Tripping devices with integral current transformer

Tripping devices **ZWA-6.3** through **ZWA-100** have an integral ring type current transformer. For motor currents less than 1.25 amps, the cables are looped through the ring openings. The number of loops is according to the Table shown below.

Number of loops (n)	5	4	3	2
Motor rated current I_n (A)	0.25-0.3	0.31-0.41	0.42-0.62	0.63-1.24

The setting current I_e of the device is calculated $I_e = n \times I_n$

Tripping limits with 3-pole symmetrical overload

Response current:	> 110% of setting current < 120% of setting current
Response time:	< 20 min starting from cold
Tripping time when test button is actuated	5 sec
Reset time on tripping	5 min (no delay after test)

Tripping times for ZWA overload relays

Tripping class	CLASS	5	10	15	20	25	30
For 3-pole symmetrical loading starting from cold							
Set current I_e	X 3	12.5	25	37	48	56	75
	X 4	7.5	17	27.5	35	41	50
	X 5	6.9	13	19	27.5	34	41
	X 6	5.2	10.2	16	20.2	27.5	35
	X 7.2	4.3	9	13	17.5	20	26
	X 8	4	8	11	16	19	24

Incoming

A 1/A 2	Rated control voltage
T 1/T 2	
C 1/C 2	Thermistor sensor (supplied in short-circuit condition with bridge)
Y 1/Y 2	
	Ground fault: SSW connection
	Hand or Auto Reset

Outgoing

95/96	NC contact	Overload/Thermistor
97/98	NO contact	Overload/Thermistor
05/06	NC contact	Ground Fault
07/08	NO contact	Ground Fault

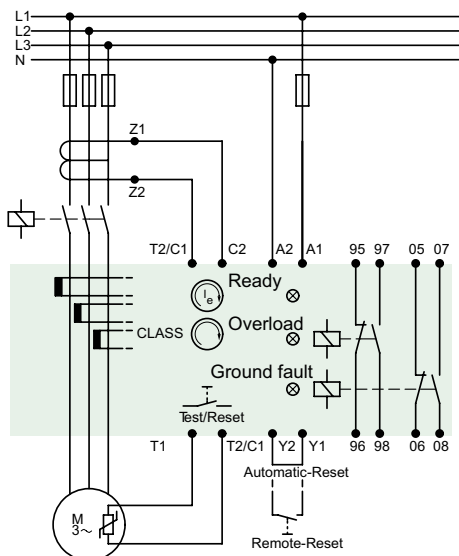

1	2	3	4	5	6
	For Use With:		Type	Price	
				\$	
Bases					
	Z00 Z1	For separate mounting	EZ00 EZ1		Snap-on fastening on 35 mm mounting rail or panel mounted.
External reset button for enclosed overload relays IP 65					
	ZE Z00 Z1 Z4 ZW7 Z5	Front ring: matt chromed black	MDE-287 MDE-287-S		Mounting diameter 22.5 mm Blue button plate: RESET
	ZE Z00 Z1 Z5 ZW7		MDA-110 MDA-110-S		Red button plate: STOP
	Z4		K-Z4		
	Z4		H1-Z4		Consisting of one cover with brackets for separate mounting. Consisting of two covers with brackets for separate mounting
	Z4		H2-Z4		
	Z5		HV DIL 6M		For line and load bolt-on terminations. (2 pieces) Provides terminations with protection against accidental contact.
	ZWA-205		PDT-A2-CP04A		PDT-A2 covers are for use between a contactor and overload relay for direct mounting.
	ZWA-500		PDT-A2-CP05A		
	ZWA-820		PDT-A2-CP06A		
	ZWA-820		PDT-A2-CP07A		

Thermistor Overload Relays

for protection of motors with P.T.C. Thermistors embedded in their windings

UL / CSA / IEC / CE

1	2	3	4	5	6
	IEC Rated operational current I_e at AC-15 220 V 230 V 240 V A	UL/CSA Pilot Duty Rating	Rated operational voltage range U_s V	Type	Price \$

Thermistor overload relays

for use with P.T.C. (Positive Temperature Coefficient) Thermistors

- With automatic reset
- Power ON and Fault indicating LED display



3

B300

24...240 V 50/60 Hz
24...240 V DC

EMT6

Same device suitable for all above voltage and frequencies!

See Price List See Price List See Price List See Price List

- Selector switch with manual/automatic reset
- For manual or remote resetting
- Test button
- Power ON and Fault indicating LED display

3

B300

24...240 V 50/60 Hz
24...240 V DC

EMT6-DB

Same device suitable for all above voltage and frequencies!

See Price List See Price List See Price List See Price List

Multi-function device

- Selector switch with manual/automatic reset.
- Short-circuit recognition in the sensor circuit.
- Reliable fault signalling even under supply voltage failure. (Zero voltage safety)
- Manual or remote resetting
- Test button
- Short-circuit recognition and zero-voltage safety can be switched off
- Power ON and Fault indicating LED display



3

B300

24-240 V 50/60 Hz
24-240 V DC

EMT6-DBK

Same device suitable for all above voltage and frequencies!

See Price List See Price List See Price List See Price List

Accessories

Panel mount adapter



Without the adapter the EMT 6 is suitable for 35mm DIN rail mounting only. The adapter enables the EMT 6 to become a panel mounted device using conventional screws.

CS-TE

See Price List See Price List See Price List See Price List

Terminal markings to EN 50 005

Flow diagrams LED display

Application notes

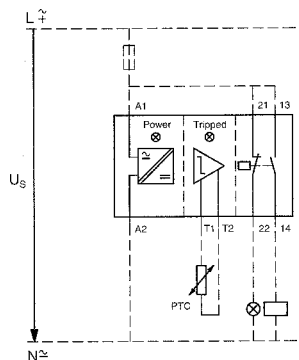
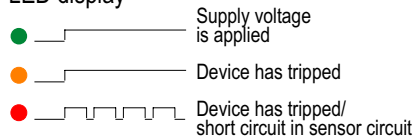

EMT 6, EMT 6-DB, EMT 6-DBK

Auto

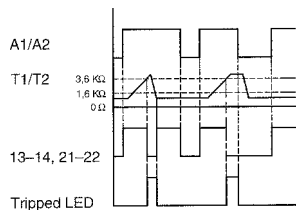

Snap fitting on 35mm DIN rail to EN 50 022-35x15

At $R_K \leq 250 \Omega$ per sensor: 6 sensors, at $R_K \leq 100 \Omega$ per sensor: 9 sensors in the winding (to be supplied by user). Max. length of thermistor cable (unscreened) 250m. Total thermistor resistance $\sum R_K \leq 1500 \Omega$

Characteristic values of sensor circuit at U_s and $+20^\circ C$

EMT 6-DB, EMT 6-DBK

Manual

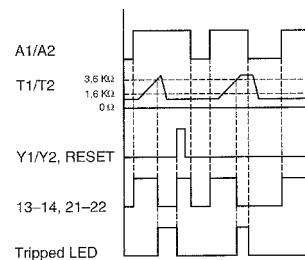
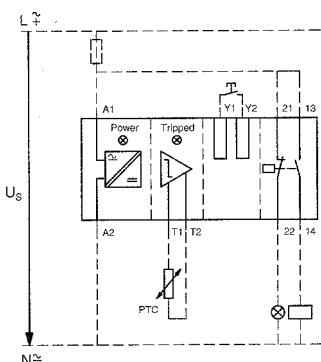

	EMT 6...	
R_{T1-T2}	U_{T1-T2} V DC max.	I_{T1-T2} mA max.
T1, T2 short-circuited	-	1.9
4 kΩ	3	0.8
T1-T2 open	5.1	-

EMT 6-DBK

Zero-voltage safe operation

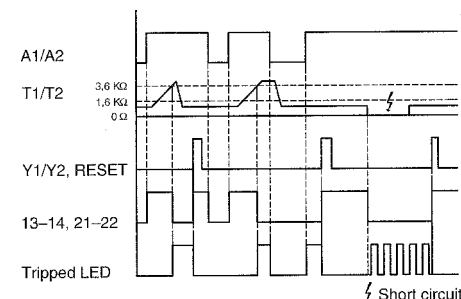
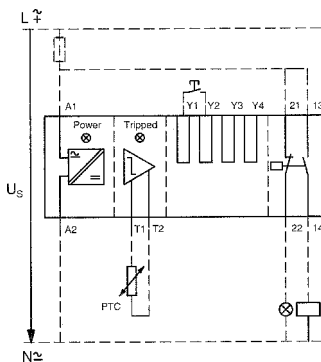

Functions which can be disconnected on EMT 6-DBK:

Function	Disconnection via jumper
Short-circuit recognition	Y_1-Y_3
Zero-voltage safety	Y_1-Y_4

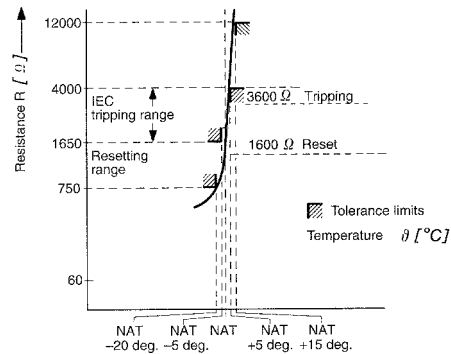

Overload Relays

Standard features for ZE, Z00, Z1, Z4, Z5 and ZW7 overload relays

3 pole adjustable overload relay. Current transformer-operated overload relay for heavy starting duty (**ZW7**).

Auxiliary contacts: NO + NC.

For mounting directly on to contactor, or for separate mounting. (Type **ZE**, direct mounting on contactor only).

Temperature compensated.

Clearly marked setting scale: Facilitates accurate setting, even for intermediate values, to motor FLC.

Setting lever for hand or auto reset: Supplied set to "Hand" (with manual reset).

Hand: After tripping, reset button must be operated. Normally associated with two-wire controls for safety reasons and to prevent "pumping".

Auto: Automatic reset after tripping. Normally associated with three-wire controls.

Reset button (internal reset): To reset after tripping when reset lever is set to "Hand".

If fault still exists, trips free even if reset button is held down.

On enclosed devices use supplementary **MDE** external reset button.

Test/OFF button: To simulate tripping of overload relay.

To de-energize self-maintaining contactors (OFF function for all types except **Z4**).

Current transformer-operated overload relays: The specified primary rated current applies to one cable loop.

For lower rated motor current, loop cable several times, e.g. **ZW7-63** for 21...31.5 A rated motor current: Loop cable twice.

Tripping Characteristics:

The tripping curves are average values of the tolerance curves at 20° C, starting from cold. Tripping time is given in relation to the tripping current. Specific characteristics for each individual setting range available on request.

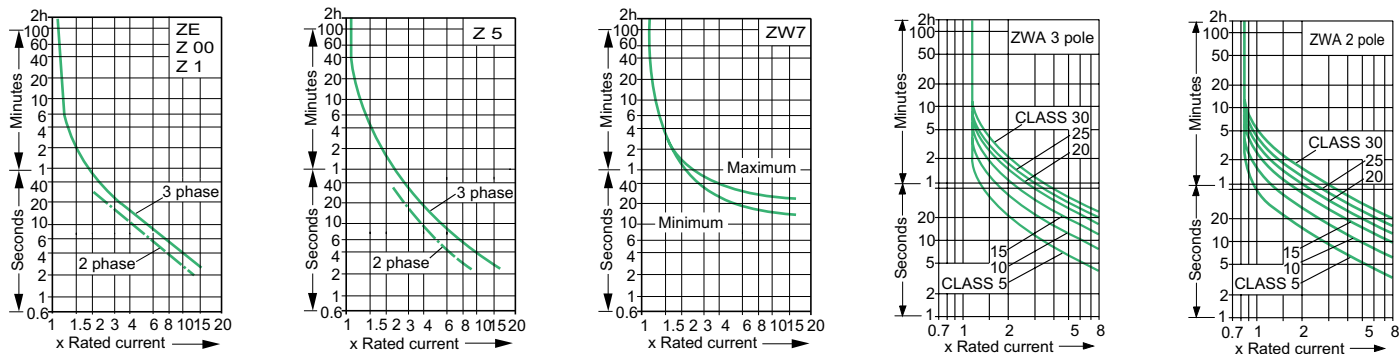

Special Note: All types have adjustable dial for setting motor full load current. Trip current is 125% of set value. For motors with a service factor (SF) of 1.0, set dial to 90% of motor full load current.

		Type →	ZE	Z00	Z1 (Z1-75)	Z4 ²⁾	ZW7
General							
Specifications			UL, CSA, IEC/EN 60 947, CE, DIN VDE 0660.....				
Climatic test			Damp heat, constant, to IEC/EN 60 068-2-3..... Damp heat, cyclic, to IEC/EN 60 068-2-30.....				
Ambient temperature	Open	max./min. °C	+ 50/-25.....				
	Enclosed	max./min. °C	+ 40/-25.....				
Temperature compensation			Continuous.....				
Dimensions			Page 4/14.....				
Mechanical shock resistance (sinusoidal shock 10 ms)		g(m/sec ²)	10.....				
Degree of protection		IP	20 00.....				
Protection against direct contact when actuated from the front by a perpendicular test finger (DIN VDE 0106, Part 100) (IEC 536)			Finger-and back-of-hand-proof.....		With terminal covers		Finger-and- back-of-hand- proof
Main circuit							
Rated voltage		V AC	600.....				
Setting current		A	0.1-12	0.1-24	6-63	50-240 (63-75)	42-540
Short-circuit protection Maximum fuse or circuit breaker			Page 4/2.....		Page 4/3.....		
Heat losses in the current paths							
Minimum setting		W	2.5	2.5	3(7)	16	3
Maximum setting		W	6	6	7.5(10)	28	10
Terminal capacities (max.)							
Solid or stranded		AWG	18...14	14...8	14...2	6...350 kcmil	8...500 kcmil
Auxiliary contacts							
Rated voltage		V AC/V DC	300/300	600/300.....			
Pilot duty rating		AC DC	D300 R300	B600/B300 same polarity/opposite polarity R300			
Rated operational current I _o AC-15 Make/break contacts							
	220/240V	A	1.5/1.5				
	380/415V	A	0.5/0.7		0.5/0.9		
	500V	A	0.3/0.5		0.5/0.8		
DC-13 ¹⁾ L/R ≤ 15 ms Make/break contacts							
	24/60/110/220V	A	0.9/0.75/0.4/0.2				

Single phase applications (all types)

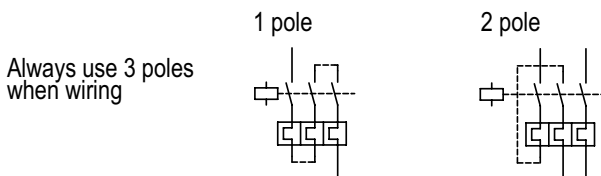

1) Making and breaking currents to DC-13, time constant as stated.
2) UL / CSA only.

Overload Relays Technical Data

Thermal Overload Relays
Thermistor Overload Relays

4

			Type →	Z5-I.K3	Z5-I.K4	Z5-FF250	ZWA
General							
Specifications				UL, CSA, IEC/EN 60 947, CE, DIN VDE 0660.....			
Climatic test				Damp heat, constant, to IEC/EN 60 068-2-3..... Damp heat, cyclic, to IEC/EN 60 068-2-30.....			
Ambient Temperature	Open Enclosed	max./min. °C max./min. °C		+ 50/-25.....+ 70/-25 + 40/-25.....			
Temperature compensation				Continuous.....			
Dimensions				Page 4/14.....			
Mechanical shock resistance (sinusoidal shock 10 ms)			g(m/sec ²)	10.....15/11			
Degree of protection			IP	00.....20 (00 >100A)			
Protection against direct contact when actuated from the front by a perpendicular test finger (DIN VDE 0106, Part 100) (IEC 536)				Finger-and back-of-hand-proof		With terminal cover	Finger-and-back- of-hand-proof
Main circuit							
Rated voltage			V AC	600.....			
Setting current			A	25-100	35-142	50-250	1.25-820
Short-circuit protection Maximum fuse or circuit breaker				Page 4/4..... As required for contactor			
Heat losses in the current paths							
Minimum setting			W	< 16..... —			
Maximum setting			W	< 28..... —			
Terminal capacities (max.)							
Solid or stranded			AWG	2	2/0	250kcmil	—
Auxiliary contacts							
Rated voltage			V AC/V DC	600/300.....			
Pilot duty rating			AC DC	B600/B300 same polarity/opposite polarity..... R300.....			
Rated operational current I _e							
AC-15							
NO/NC			A	— — — 6/6			
contacts			A	1.5/1.5..... 3/3			
			A	0.5/0.9..... —			
			A	0.5/0.8..... —			
DC-13 ¹⁾							
L/R ≤ 15 ms							
NO/NC							
contacts			A	0.9/0.75/0.4/0.2..... 2 @ 24V			

1) Making and breaking currents to DC-13, time constant as stated.

			EMT 6 Thermistor relay
General			
Specifications			UL, CSA, IEC/EN 60 947, CE, DIN VDE 0660, EN 55 011
Climatic test			Damp heat, constant, to IEC/EN 60 068-2-3 Damp heat, cyclic, to IEC/EN 60 068-2-30
Ambient Temperature	Open Enclosed	max./min. °C max./min. °C	+ 60/-25 + 45/-25
Mounting position			As desired
Dimensions			Page 4/17
Weights		kg	0.15
Mechanical shock resistance (sinusoidal shock 10 ms)		g(m/sec ²)	10
Degree of protection		IP	20
Protection against direct contact when actuated from the front by a perpendicular test finger (DIN VDE 0106, Part 100) (IEC 536)			Finger-and back-of-hand-proof
Auxiliary and Control Circuits			
Terminal capacities			
Solid or stranded		AWG	16...14
Terminal Torque rating		Nm	0.8...1.2
Auxiliary circuit			
Rated insulation voltage U _i		V	400
Rated operational voltage U _e		V	400
UL/CSA Pilot duty rating		AC	B300
IEC Rated operational current I _e			
AC-14 NO/NC contacts	380/415V	A	3/3
AC-15 NO/NC contacts	240V	A	3
	380/415V	A	1/1
Short Circuit rating without welding Maximum Fuse		A gL	6
Control Circuit			
Rated insulation voltage U _i		V	240
Rated operational voltage U _e		V	240
Voltage Tolerance range			0.85...1.1 x U _e
Power Consumption		VA W	3.5 2
Tripping takes place at appr.		Ω	≥ 3600
Recovery takes place at appr.		Ω	≥ 1600

Dimensions

ZE

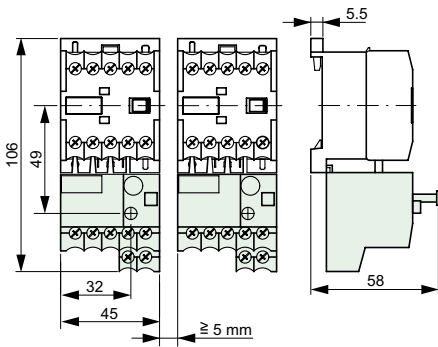

Z00 + EZ00 + MDE Z1 + EZ1 + MDE

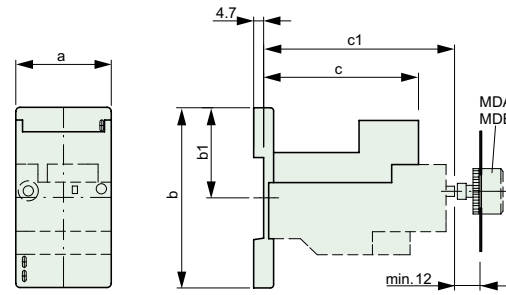

	EZ00	EZ1
a	45	60
a1	35	50
a2	34	41.5
a3	22.5	30
b	85	86
b1	42.5	42.5
b2	60	—
b3	75	75
b4	41	36
b5	7.5	—
c	73	112
c1	90	102

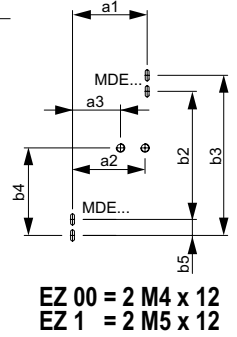

EZ 00 = 2 M4 x 12
EZ 1 = 2 M5 x 12

Z5-.../SK

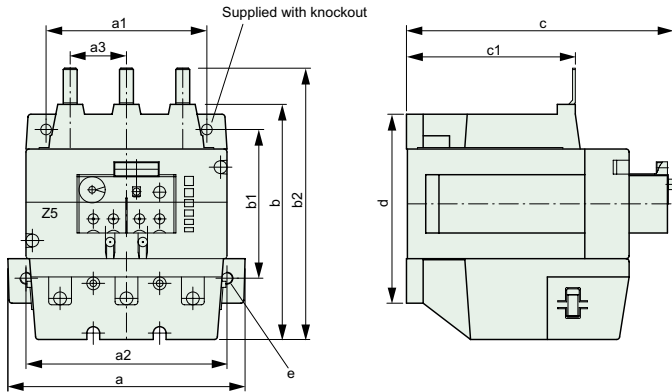

	Z5-.../SK3	Z5-.../SK4
a	100	118
a1	80	80
a2	80	100
a3	28	28
b	117	117
b1	74	74
b2	135	135
c	133	133
c1	82.5	84
d	94	94
e	Ø 6	Ø 7

Z5-.../KK

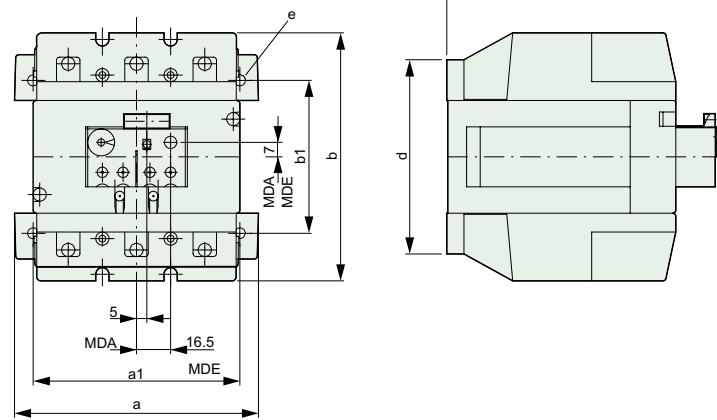

	Z5-.../KK3	Z5-.../KK4
a	100	118
a1	80	100
b	120	120
b1	74	74
c	133	133
d	94	94
e	Ø 6	Ø 7

Z5-.../FF250

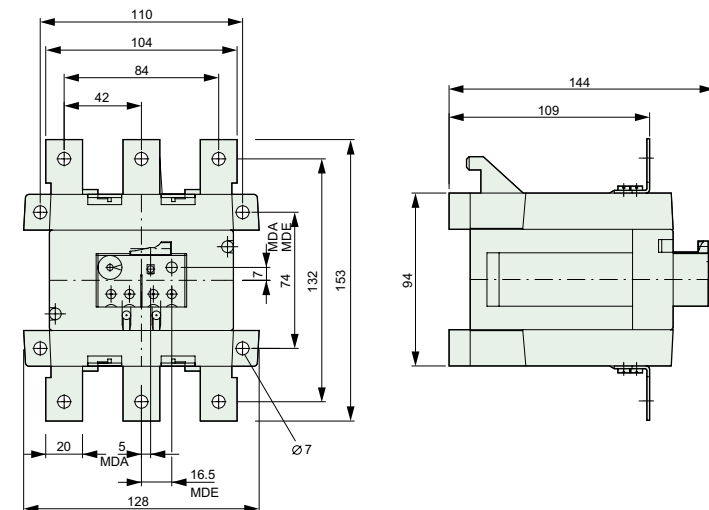

Z4... + K-Z4 + MDE

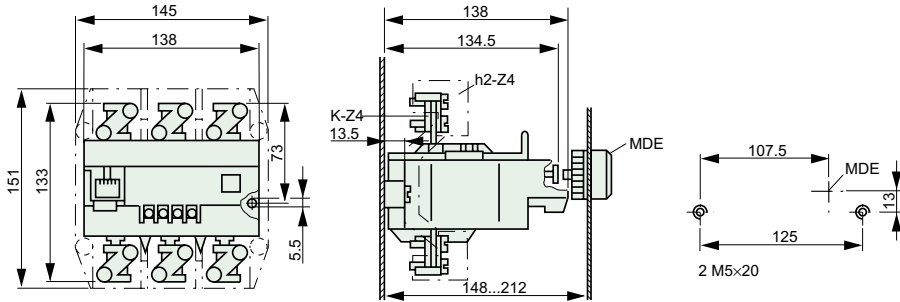

Z4-240/K-NA
Z4-240-CNA

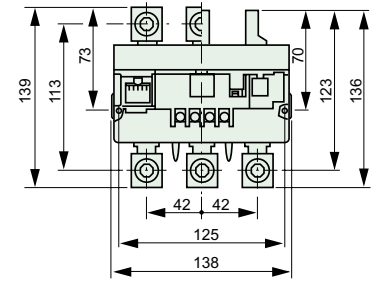

Current transformer operated overload relays

ZW7... + MDE

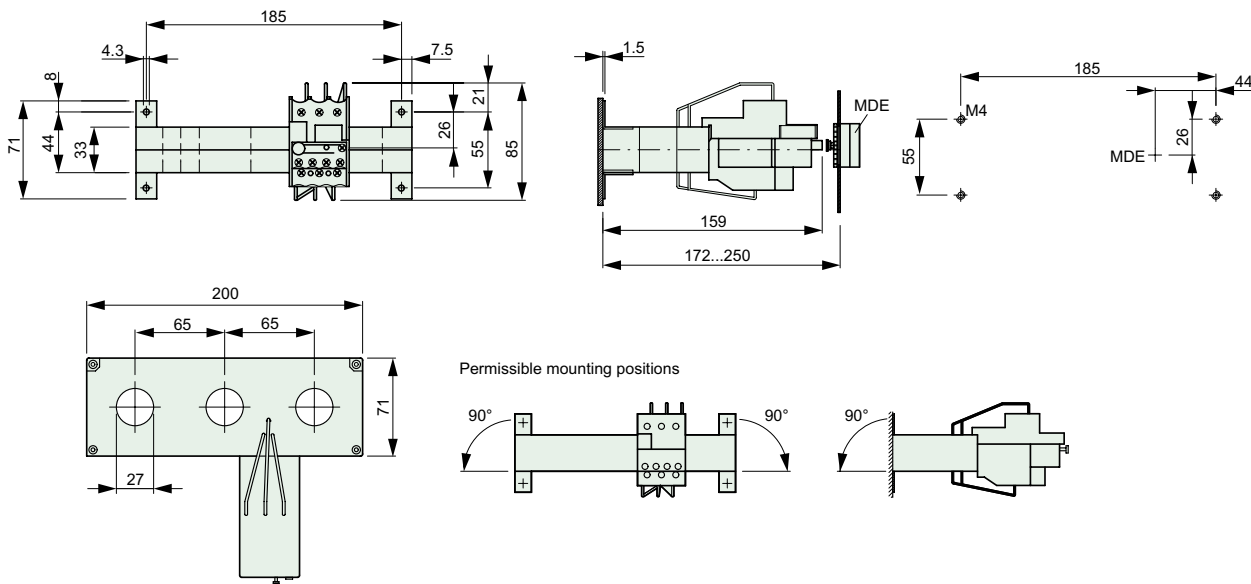

External reset buttons

MDE
MDA

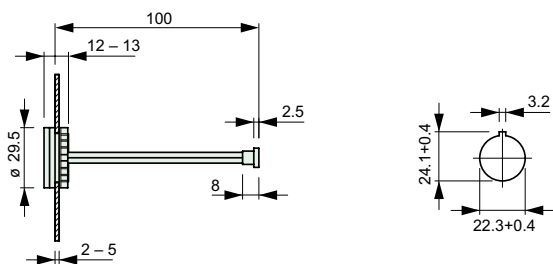

HV DIL 6M

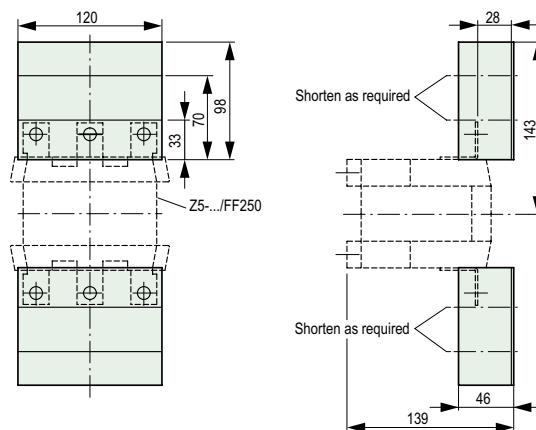

Dimensions

ZWA-6.3, ZWA-25, ZWA-100

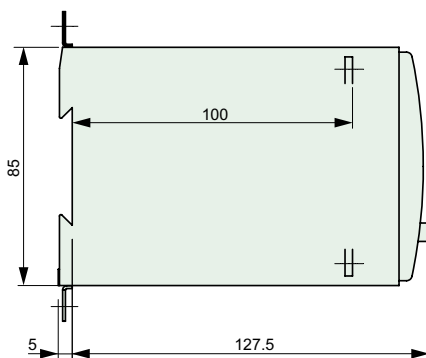
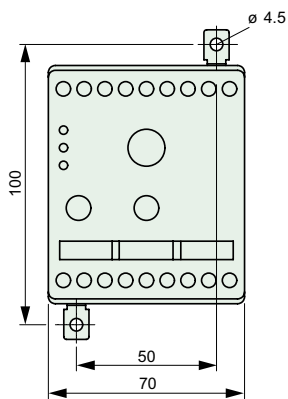

	ZWA-6.3 ZWA-25	ZWA-100
a	10	15
b	34	29
c	46	47
c1	29	24
d	4	-

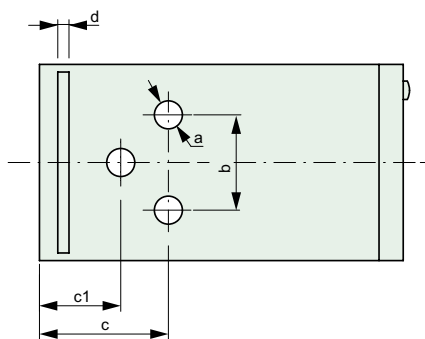

ZWA-205, ZWA-500, ZWA-820

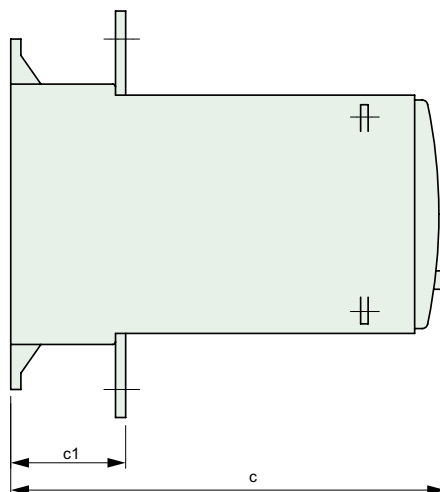
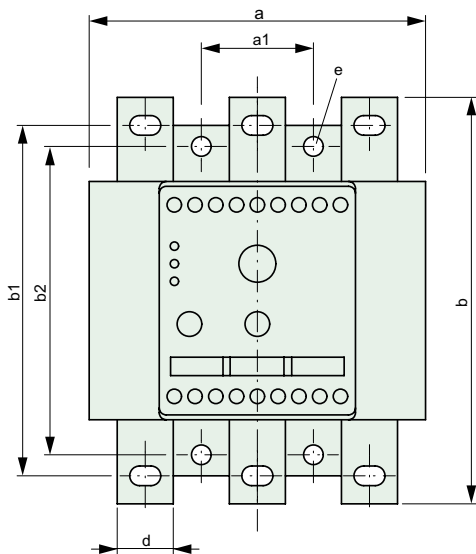

	ZWA-205	ZWA-500	ZWA-820
a	120	145	230
a1	40	50	70
b	145	160	175
b1	125	130	135
b2	110	105	120
c	155	175	190
c1	41	46	55
d	20	30	40
e	7	9	11

SSW 40-..., SSW 65-..., SSW 120-...

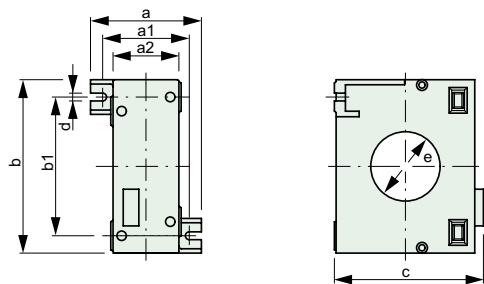

	SSW 40-...	SSW 65-...	SSW 120-...
a	64	75	86.5
a1	50	60	70
a2	38	43	54.5
b	100	124	200
b1	80	100	170
c	86	112	205
d	4.5	4.5	4.5
e	40	65	120

EMT 6 Thermistor Overload Relay

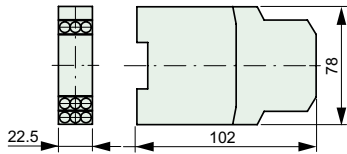

PDT-A2-CP 04A

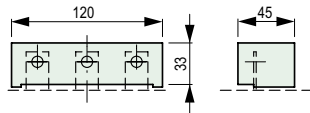

PDT-A2-CP 05A

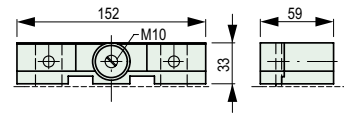

PDT-A2-CP 06A
PDT-A2-CP 07A

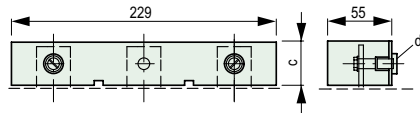

PDT-A2	CP 06A	CP 07A
c	38	48
d	M10	M12

SSW 40-...
SSW 65-...
SSW 120-...

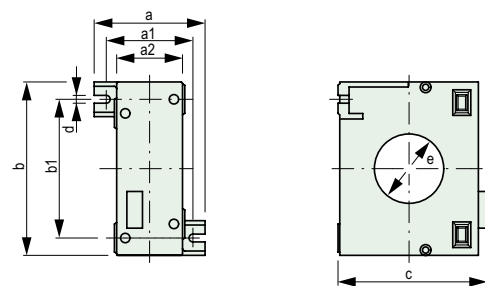

	SSW 40-...	SSW 65-...	SSW 120-...
a	64	75	86.5
a1	50	60	70
a2	38	43	54.5
b	100	124	200
b1	80	100	170
c	86	112	205
d	4.5	4.5	4.5
e	40	65	120

