

Protection components

VARIO switch disconnectors, 12 to 175 A
Complete units

References

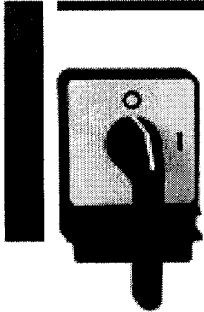

VCC-6

3-pole main and emergency stop switch disconnectors - package units (1)

Handle	Front plate mm	Fixing	Marking	Rating A	Reference	Weight kg
Red padlockable with up to 3 padlocks Padlocks not supplied.	60 x 60 Yellow	4 screws	L ₁ (2)	12	VCC-02	0.360
				20	VCC-01	0.360
				25	VCC-0	0.360
				32	VCC-1	0.360
				40	VCC-2	0.360
				63	VCC-3	0.770
				80	VCC-4	0.770
Red, cross type padlockable with up to 3 padlocks Padlocks not supplied.	91 x 128 Yellow	4 screws	L ₁ (2)	125	VCC-5	1.400
				175	VCC-6	1.400

(1) Package units comprise switch body, operator, door interlock, extension shaft, incoming terminal shroud, and seal to give ingress protection IP 65 where appropriate.
(2) During the lifetime of this catalogue the front plate marking will change to $\circ \perp$

Switch disconnector mounted on rear of enclosure

Switch disconnectors

VCC02 to VCC4

V02, V01, V0 to V4 with shaft extension VZ-17 or VZ-30

(Clip-on mounting on top hat rail possible for V0 to V2)

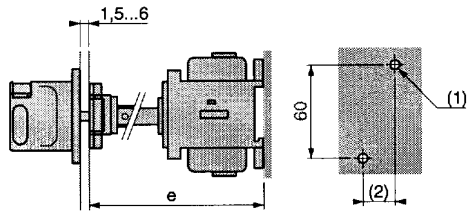

(1)	2 x \varnothing 4.2	: V0, V0 to V2
	2 x \varnothing 5	: V3, V4
(2)	15	: V0, V0 to V2
	20	: V3, V4

VCC5 and VCC6

V5 and V6 with shaft extension

VZ-18 or VZ-31

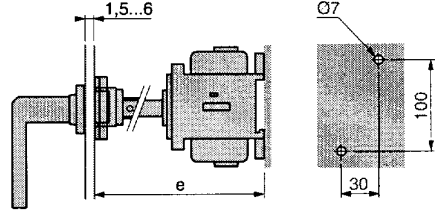

	Distance (e) encl. back/door mm	Shaft Extension		Distance (e) encl. back/door mm	Shaft Extension
V02 and V01, VCC02, VCC01	300...330	VZ 17	V3 and V4, VCC3 and VCC4	400...420	VZ 30
V0 to V2, VCC0 to VCC2	400...430	VZ 30		330...350	VZ 18
	300...320	VZ 17	V5 and V6, VCC5 and VCC6	430...450	VZ 31

Protection components

VARIO switch disconnectors, 12 to 175 A
Complete units

References

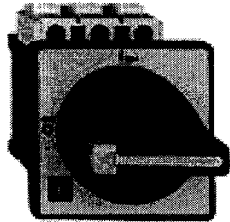

VCF-02

3-pole main and emergency stop switch disconnectors with handle assembly

Handle	Front plate mm	Fixing	Marking	Rating A	Reference	Weight kg
Red padlockable with up to 3 padlocks Padlocks not supplied.	60 x 60 Yellow	4 screws		12	VCF-02	0.250
				20	VCF-01	0.250
				25	VCF-0	0.250
				32	VCF-1	0.250
				40	VCF-2	0.250
				63	VCF-3	0.560
Red, cross type padlockable with up to 3 padlocks Padlocks not supplied.	91 x 128 Yellow	4 screws		125	VCZ-5	1.200
				175	VCZ-6	1.200

Switch disconnector front mounted on enclosure
V0●, V0 to V4
VCF0●, VCF0, to VCF4

Fixing by 4 screws

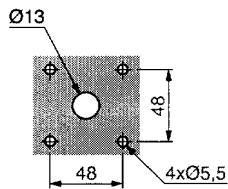
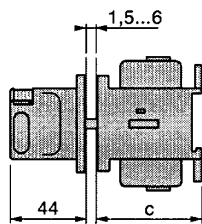

V5 and V6
VCZ5 and VCZ6

Fixing by 4 screws

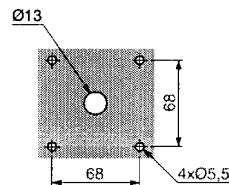
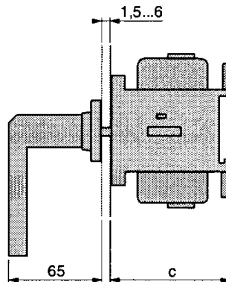

Switch body height

	c
V0●, V0 to V2, VCF0●	60
V3, V4, VCF3, VCF4	65
V5, V6, VCZ5, VCZ6	90

Protection components

VARIO enclosed switch disconnectors, 12 to 175 A
Enclosures with handle only

References

Dimensions :
page 1/136

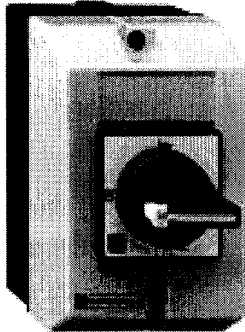

VCFX-GE

Enclosures fitted with padlockable handle.

Supplied without switch disconnector

With black padlockable handle and black front plate for mounting a main switch disconnector

For mounting switch body type	Front plate marking	Itthe A	Possible attachment Neutral pole module + Block with 2 auxiliary contacts	Reference	Weight kg
V02 thro' V2		10 to 32	1 x VZ-11 + 1 x VZ-7 or 1 x VZ-20	VBFX-GE1	0.700
V3, V4		50 to 63	2 x VZ-7 or 2 x VZ-20 3 add-on modules see page 1/137	VBFX-GE2	0.700

With red padlockable handle and yellow front plate

for mounting a main or emergency stop switch disconnector

For mounting switch body type	Front plate marking	Itthe A	Possible attachment Neutral or main pole module + Block with 2 auxiliary contacts	Reference	Weight kg
V02 thro' V2		10 to 32	1 x VZ-11 or VZ-7 + VZ-7 or VZ-20 or 2 x VZ-20	VCFX-GE1	0.700
V3, V4		50 and 63	3 add-on modules : see page 1/138	VCFX-GE2	1.130

(1) Enclosures VCF have an IP 65 degree of protection and are sealable and lockable.

(2) 1 add-on module may be fitted: see page 1/137.

(3) 3 add-on modules can be fitted : see page 1/137.

(4) 1 neutral pole module VZ-13 or 1 auxiliary contact module (VZ-7 or VZ-20) may be fitted.

Also available: Vario 6-pole enclosed switch disconnectors with 2 auxiliary contacts, consult your Regional customer centre.

Enclosures VoFX-GE1 and VoFX-GE2

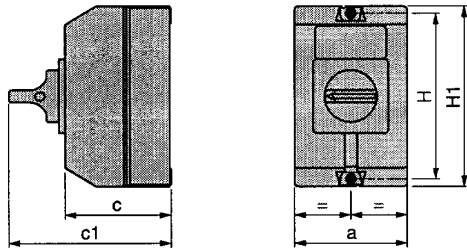

	VoFX-GE1	VoFX-GE2
a	90	150
c	85	106
c1	131	152
H	130	154
H1	146	170

Protection components

VARIO switch disconnectors, 12 to 175 A
 Components for customer assembly
 Switch bodies, add-on modules, auxiliary contacts

References

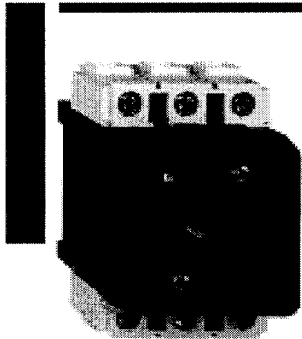

V2

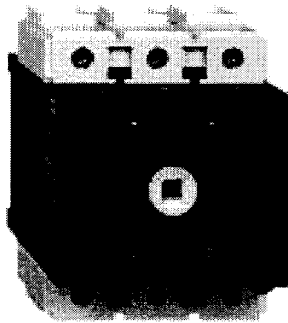

V5

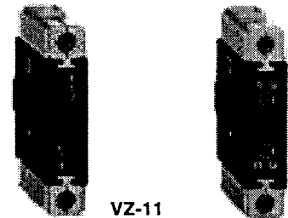

VZ-11

VZ-14

Switch bodies

Description	Rating A	Reference	Weight kg
3-pole switch disconnectors (1)	12	V02	0.200
	20	V01	0.200
	25	V0	0.200
	32	V1	0.200
	40	V2	0.200
	63	V3	0.500
	80	V4	0.500
	125	V5	0.900
175	V6	0.900	

Add-on modules

Main pole module (1)	Rating	Reference	Weight kg
	12	VZ-02	0.050
	20	VZ-01	0.050
	25	VZ-0	0.050
	32	VZ-1	0.050
	40	VZ-2	0.050
	63	VZ-3	0.100
	80	VZ-4	0.100

Neutral pole module with early make and late break contacts (1)	Rating	Reference	Weight kg
	12 to 40	VZ-11	0.050
	63 and 80	VZ-12	0.100
	125 and 175	VZ-13	0.250

Earthing module	Rating	Reference	Weight kg
	12 to 40	VZ-14	0.050
	63 and 80	VZ-15	0.100
	125 and 175	VZ-16	0.250

Auxiliary contact block module with 2 auxiliary contacts	Rating	Reference	Weight kg
	N/O + N/C (2)	VZ-7	0.050
	N/O + N/O	VZ-20	0.050

(1) Protection shrouds are available if required : see page 1/140.

(2) Late make N/O contact, early break N/C contact.

Switch disconnectors V0e, V0 to V2

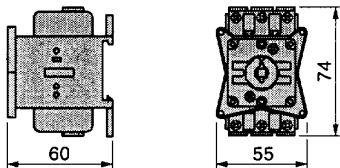

V3 to V6

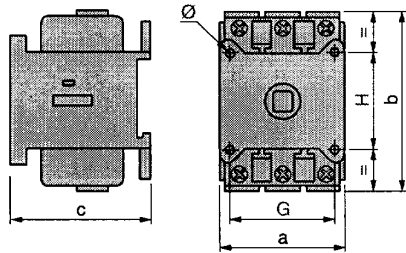

	a	b	c	G	H	Ø
V3, V4	60	83	65	48	48	5.5
V5, V6	90	125	90	68	68	5.5

Add-on modules VZ-02 to VZ-4 VZ-11 to VZ-16

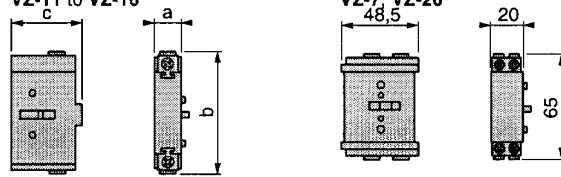

	a	b	c
VZ-02 and VZ-01, VZ-0 to VZ-2, VZ-11, VZ-14	16	74	35
VZ-3, VZ-4, VZ-12, VZ-15	20	83	46
VZ-13, VZ-16	30	125	63

Protection components

VARIO switch disconnectors, 12 to 175 A Mounting options - Add-on modules

Any combination of contacts may be fitted subject to the following rules :

Switch types V02 to V4

A maximum of 3 main poles may be added to a switch body - 2 on one side and one on the other.

When mounting a mixture of main poles and other attachments, the main poles must always be mounted nearest the main switch body with other attachments outside.

A maximum of 4 attachments may be fitted in total.

When fitting main poles, always select a main pole of the same rating as the switch body.

3 Main pole attachments (same rating as switch body)
+ 1 other attachment

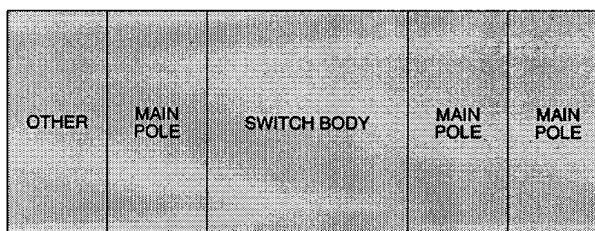

1 Main pole (same rating as switch body) with up to 3 other attachments (NB: earthing module should always be fitted furthest from switch body).

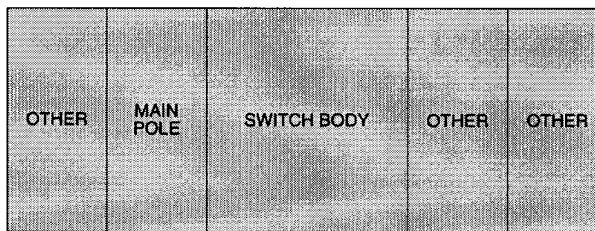

Main pole may be fitted either side next to switch body.

Switch types V5 and V6

Two attachments may be fitted, selected from Neutral pole module VZ-13, earthing module VZ-16 and an auxiliary contact module.

When fitting 2 attachments, always fit one on each side of the switch body.

Two attachments maximum.

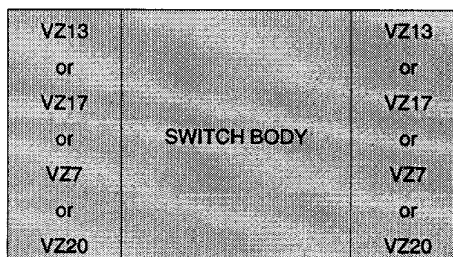

Protection components

VARIO rotary switch disconnectors, 12 to 175 A
 Components for customer assembly
 Operators, handles and front plates

References

Handles and front plates for main and emergency stop switch disconnectors

Rating of switch body	Operator Red handle	Yellow front plate		Degree of protection	Marking	Reference	Weight
		Dimensions	Fixing				
mm							
12 to 40 A	Padlockable with 1 padlock (2)	45 x 45	Ø 22.5	IP 65	○↓	KCC-1YZ	0.050
			4 screws	IP 40 (3)	○↓	KCE-1YZ	0.040
	Padlockable with up to 3 padlocks (2)	60 x 60	Ø 22.5	IP 65	○↓	KCD-1YZ	0.075
			4 screws	IP 40 (3)	○↓	KCF-1YZ	0.060
	Padlockable with up to 3 padlocks (2)	60 x 60	4 screws	IP 65	○↓	KCF-1PZ	0.075
63 and 80 A	Padlockable with up to 3 padlocks (2)	60 x 60	4 screws	IP 40 (3)	○↓	KCF-2YZ	0.070
			4 screws	IP 65	○↓	KCF-2PZ	0.070
	Padlockable with up to 5 padlocks (2)	90 x 90	4 screws	IP 40 (3)	○↓	KCG-2YZ (1)	0.100
125 and 175 A	Cross type, padlockable with up to 3 padlocks (2)	90 x 128	4 screws	IP 40 (3)	○↓	KCH-2TZ	0.260

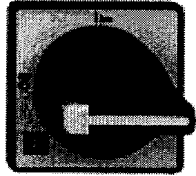

KCF-1PZ

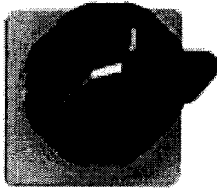

KCF-2YZ

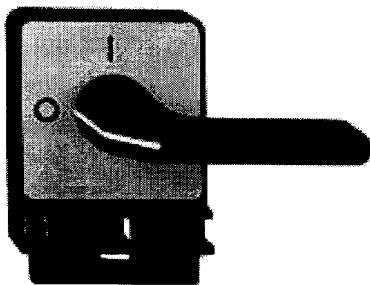

KCH-2TZ

(1) For direct control by this handle, order adaptor plate KZ-106, see page 1/141.

(2) Padlocks not supplied.

(3) Sealing kit available to give IP 65 degree of protection - see page 1/141.

Protection components

VARIO switch disconnectors, 12 to 175 A
Components for customer assembly
Accessories

References

Components for door interlocking

For rear mounted switches

Description	For use with ratings A	Distance (e) incl. back/door mm	Sold in lots of	Unit reference	Weight kg
Shaft extension	12...40	300...330	1	VZ-17	0.075
		400...430	1	VZ-30	0.125
	63...80	300...320	1	VZ-18	0.170
		400...420	1	VZ-31	0.215
	125 and 175	330...350	1	VZ-18	0.170
		430...450	1	VZ-31	0.215
Door interlock plate	12...40	-	5	KZ-32	0.020
	63...175	-	5	KZ-74	0.020

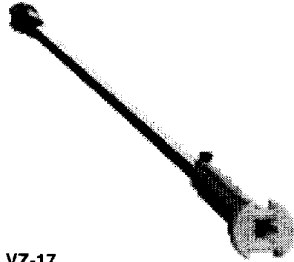

VZ-17

Accessories for handle assemblies

Description	Application		Sold in lots of	Unit reference	Weight kg
Legend bearer with silver coloured blank legend plate	For use with operator size	45 x 45	5	KZ-13	0.060
		60 x 60	5	KZ-15	0.065
		90 x 90	5	KZ-103	0.070
Legend bearer without legend plate	For use with operator size	45 x 45	20	KZ-14	0.060
		60 x 60	10	KZ-16	0.065
		90 x 90	5	KZ-101	0.070
Silver coloured blank legend plate for engraving by customer	For use with bearer ref.	KZ-14	20	KZ-76	0.020
		KZ-16	10	KZ-77	0.010
		KZ-101	5	KZ-100	0.005
Blank legend plate for engraving by customer	For front plate 45 x 45	Black	20	KZ-17	0.030
		Silver	20	KZ-18	0.030
		Yellow	10	KZ-19	0.015
	For front plate 60 x 60	Black	20	KZ-20	0.040
		Silver	20	KZ-21	0.040
		Yellow	1	KZ-22	0.040
	For front plate 90 x 90	Black	20	KZ-23	0.040
		Silver	20	KZ-24	0.040
		Yellow	1	KZ-25	0.040
Adaptor plate for 63 and 80 A switch disconnectors	For front mounting of 90 x 90 handle assembly		5	KZ-106	0.075
IP 65 sealing kit for IP 40 operator	45 x 45	Switch rating 12...40 A	2	KZ-80	0.005
		60 x 60	12...40 A	2	KZ-83
		63...80 A	2	KZ-81	0.010
	90 x 90	63...175 A	2	KZ-82	0.015
Tightening tool	For control units with Ø 22.5 fixing		5	Z01	0.050

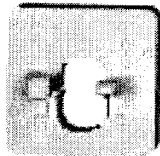

KZ-32

Input terminal protection shrouds

	Switch rating		Unit reference	Weight
For switch bodies (3-pole shroud)	12...40 A	1	VZ-8	0.015
	63...80 A	1	VZ-9	0.020
	125 and 175 A	1	VZ-10	0.060
For add-on pole modules (single-pole shroud)	12 to 40 A	1	VZ-26	0.005
	63 and 80 A	1	VZ-27	0.007
	125 and 175 A	1	VZ-28	0.020
For contact block with 2 auxiliary contacts	-	1	VZ-29	0.005



VZ-8

Protection components

VARIO switch disconnectors, 10 to 140 A

References, dimensions, schemes

References :
pages 1/136 to 1/142

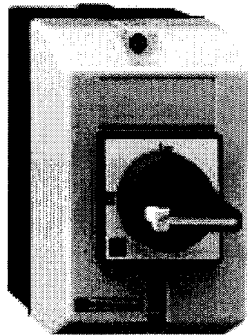

VCF-06GE

Enclosed main and emergency stop switch disconnectors

Operator	Yellow front plate		Ithe	Power AC-23 at 400 V	Possible attachment	Reference	Weight
	Dimensions	Marking					
	mm		A	kw			kg
Padlockable With up to 3 padlocks (padlocks not supplied)	60 x 60		10	4	(2)	VCF-02GE	0.500
			16	5.5	(2)	VCF-01GE	0.500
			20	7.5	(2)	VCF-06GE	0.500
			25	11	(2)	VCF-1GE	0.500
			32	15	(2)	VCF-2GE	0.500
			50	22	(3)	VCF-3GE	0.930
Cross type, padlockable with up to 3 padlocks (padlocks not supplied)	91 x 128		100	37	(4)	VCZ-5GE	2.190
			140	45	(4)	VCZ-6GE	2.190

Enclosures VøF-02GE to VøF-4GE VøFX-GE1 and VCFX-GE2

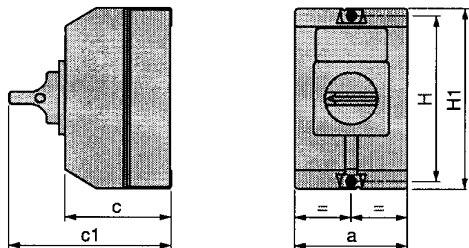

	VøF-02GE to VøF-2GE VøFX-GE1	VøF-3GE and VøF-4GE VCFX-GE2
a	90	150
c	85	106
c1	131	152
H	130	154
H1	146	170

VøZ-5GE and VøZ-6GE

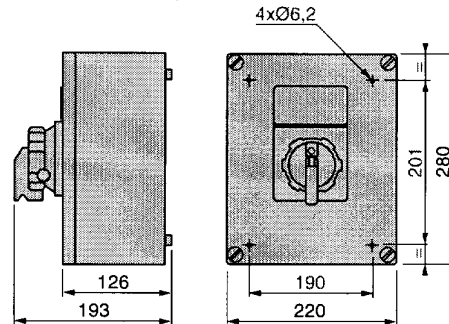

Protection components

Load break switch-disconnectors, type LK3, 40 to 1250 A
3 and 4-pole

References

Dimensions :
page 1/145

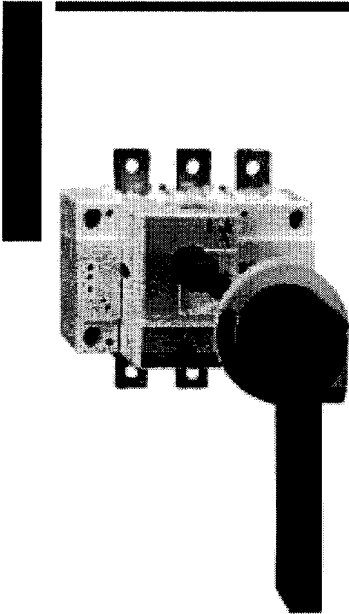

LK31-BC●●

Switch-disconnector kits (1)

Marking	Thermal rating I _{th} A	Motor switching F.L.C rating AC-22 A (400 V) A	AC-23 A rating (400 V) A	No. of poles (S.N. = solid neutral)	Reference	Weight kg
0 I V	40	40	40	3	LK3-AP30	0.535
				4	LK3-AP40	0.555
	63	63	50	3	LK3-AR30	0.535
				4	LK3-AR40	0.555
	80	80	63	3	LK3-AT30	0.580
				4	LK3-AT40	0.620
125	100	80	3	LK31-AT30	0.580	
			4	LK31-AT40	0.620	
I o	160	160	125	3	LK31-BC30	1.895
				4	LK31-BC40	2.105
				3 + S.N.	LK31-BC50	2.005
	250	250	250	3	LK31-BG30	2.810
				4	LK31-BG40	2.925
				3 + S.N.	LK31-BG50	2.925
315	315	315	3	LK31-BJ30	4.305	
			4	LK31-BJ40	5.075	
			3 + S.N.	LK31-BJ50	4.975	
400	400	400	3	LK31-BN30	4.305	
			4	LK31-BN40	5.075	
			3 + S.N.	LK31-BN50	4.975	
630	630	400	3	LK31-BS30	4.475	
			4	LK31-BS40	5.395	
			3 + S.N.	LK31-BS50	5.195	
o L	800	800	800	3	LK3-BV30	9.370
				4	LK3-BV40	10.990
	1250	1250	1000	3	LK3-CD30	11.720
			4	LK3-CD40	14.600	

(1) The kit references indicated above comprise : switch-disconnector body, shaft extension (200 mm), door interlock, power terminal screen, red padlockable handle (single sided for LK3-AP/AR/AT and LK31-AT/BC/BG/BJ/BN/BS, double sided for LK3-BV/CD) and escutcheon plate (black inscription on yellow background).

Auxiliary contacts

Description	For switch-disconnectors type	Reference	Weight kg
First auxiliary contact for signalling applications 1 N/O + 1 N/C	LK3-AP/AR/AT and LK31-AT	LA8-SATA1	0.020
	LK31-BC/BG/BJ/BN/BS	LA81-SBPA1	0.020
	LK3-BV/CD	LA8-SBPA1	0.020
Second auxiliary contact for signalling applications 1 N/O + 1 N/C	LK3-AP/AR/AT and LK31-AT	LA8-ZATA2	0.020
	LK31-BC/BG/BJ/BN/BS	LA81-ZBPA2	0.020
	LK3-BV/CD	LA8-ZBPA2	0.020
Other versions	Changeover and mechanically interlocked switch-disconnectors. For further information please consult your Regional customer centre.		

Protection components

Load break switch-disconnectors, type LK3, 40 to 1250 A
3 and 4-pole

References

Dimensions :
page 1/147

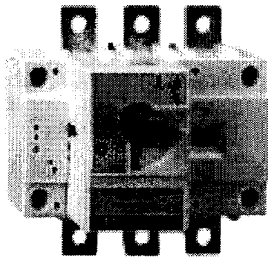

LK31-BC3



LA8-ZBPD8

Switch-disconnector bodies

For switch-disconnectors type	Reference	Weight kg
40 to 80 A		
LK3-AP30	LK3-AP3	0.300
LK3-AP40	LK3-AP4	0.320
LK3-AR30	LK3-AR3	0.300
LK3-AR40	LK3-AR4	0.320
LK3-AT30	LK3-AT3	0.330
LK3-AT40	LK3-AT4	0.370
125 to 630 A		
LK31-AT30	LK31-AT3	0.330
LK31-AT40	LK31-AT4	0.370
LK31-BC30	LK31-BC3	1.100
LK31-BC40	LK31-BC4	1.300
LK31-BC50	LK31-BC5	1.200
LK31-BG30	LK31-BG3	2.000
LK31-BG40	LK31-BG4	2.100
LK31-BG50	LK31-BG5	2.100
LK31-BJ30	LK31-BJ3	3.430
LK31-BJ40	LK31-BJ4	4.180
LK31-BJ50	LK31-BJ5	4.080
LK31-BN30	LK31-BN3	3.430
LK31-BN40	LK31-BN4	4.180
LK31-BN50	LK31-BN5	4.080
LK31-BS30	LK31-BS3	3.600
LK31-BS40	LK31-BS4	4.500
LK31-BS50	LK31-BS5	4.300
800 A		
LK3-BV30	LK3-BV3	8.000
LK3-BV40	LK3-BV4	9.600
1250 A		
LK3-CD30	LK3-CD3	10.300
LK3-CD40	LK3-CD4	13.150

Handles

Door interlocked handle assemblies Padlockable Red handle	Single sided	For LK3-AP/AR/AT and LK31-AT	LA8-SATD6	0.020
		For LK31-BC/BG/BJ/BN/BS	LA81-ZBPD7	0.069
	Double sided	For LK3-BV/CD	LA8-ZBPD8	0.470
Direct mounted handle assembly	Single sided Padlockable	For LK31-BC/BG/BJ/BN/BS	LA81-ZBPD3	0.060

Protection components

Load break switch-disconnectors, type LK3, 40 to 1250 A
3 and 4-pole

References

Dimensions :
page 1/145

Door interlocks

Description	For switch-disconnectors type	Reference	Weight kg
Door interlocks (1)	LK3-AP/AR/AT and LK31-AT	LA8-SATE	0.150
	LK3-BV/CD	LA81-ZBVE	0.340

Shaft extensions

200 mm shaft extension	LK3-AP/AR/AT and LK31-AT	LA8-SATC	0.065
	LK31-BC/BG/BJ/BN/BS	LA81-ZBPC1	0.415
	LK3-BV/CD	LA8-ZBPC2	0.415
320 mm shaft extension	LK31-BC/BG/BJ/BN/BS	LA81-ZBPC2	0.625

Terminal screens

Terminal screens	LK3-AT and LK31-AT	LA8-SATB	0.015
	LK31-BC30	LA8-SBPB1	0.020
	LK31-BC40/BC50	LA8-SBPB2	0.030
	LK31-BG30	LA8-SBPB3	0.035
	LK31-BG40/BG50	LA8-SBPB4	0.050
	LK31-BJ30/BN30/BS30	LA8-SBPB5	0.100
	LK31-BJ40/BJ50/BN40/BN50/ BS40/BS50	LA8-SBPB6	0.120
	LK3-BV30	LA8-SBPB7	0.145
	LK3-BV40	LA8-SBPB8	0.165
	LK3-CD30	LA8-SBPB9	0.195
LK3-CD40	LA8-SBPB10	0.225	

Terminal shrouds

Terminal shrouds IP 2X	LK3-AT and LK31-AT	LA81-SATB	0.015
	LK31-BC30	LA81-SBPB1	0.020
	LK31-BC40/BC50	LA81-SBPB2	0.030
	LK31-BG30	LA81-SBPB3	0.035
	LK31-BG40/BG50	LA81-SBPB4	0.050
	LK31-BJ30/BN30/BS30	LA81-SBPB5	0.100
	LK31-BJ40/BJ50/BN40/BN50/ BS40/BS50	LA81-SBPB6	0.120

Mounting accessory

Spacers	LK31-BC	LK8-ZBPA1
	LK31-BG	LK8-ZBPA2

(1) LK31-AT/BC/BG/BJ/BN/BS have the door interlock incorporated in the handle assembly.

Protection components

Load break switch-disconnectors, type LK3, 40 - 1250 A

Selection guide for 3 and 4-pole versions
Changeover and mechanically interlocked
switch-disconnectors (6 or 8-pole)

References :
pages 1/144 to 1/145

The 4-pole versions are illustrated : the 3-pole versions have identical dimensions but the left pole is omitted.

LK3-AP● and LK3-AR●

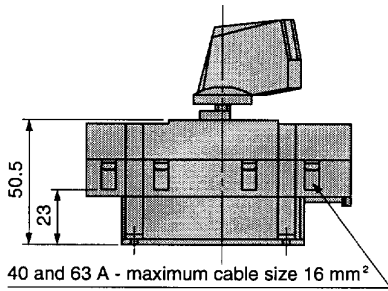

Direct operation

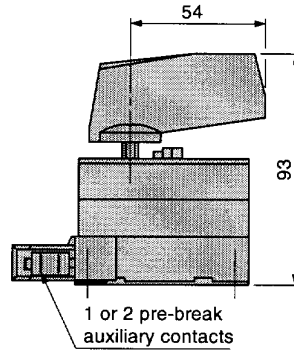

LK3-AT● and LK31-AT●

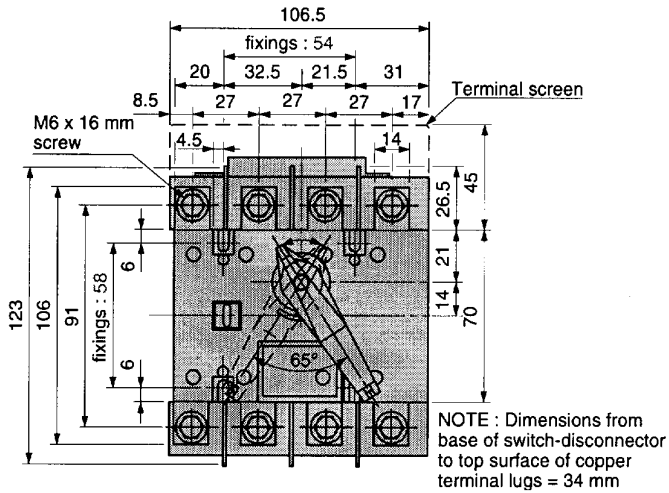

External operation

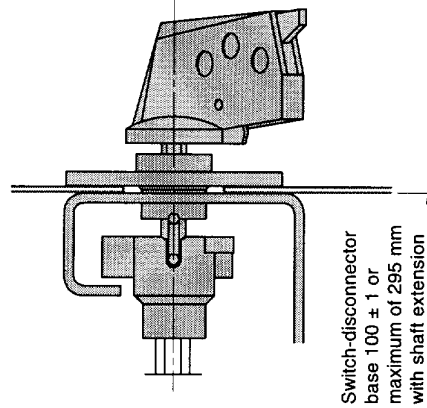

LK3-AP● and LK3-AR●

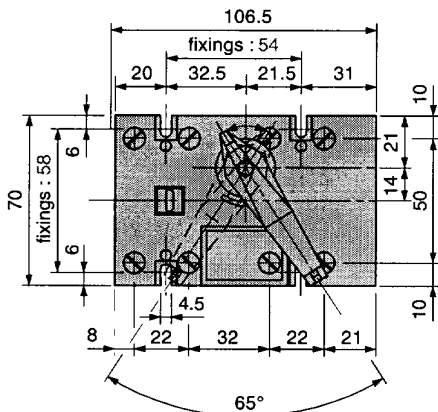

Door drilling

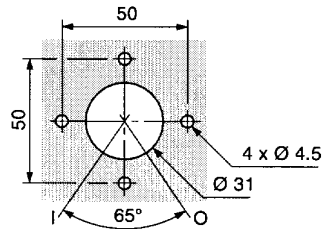

Protection components

Load break switch-disconnectors, type LK3, 40 - 1250 A

Selection guide for 3 and 4-pole versions
Changeover and mechanically interlocked
switch-disconnectors (6 or 8-pole)

References :
pages 1/144 to 1/145

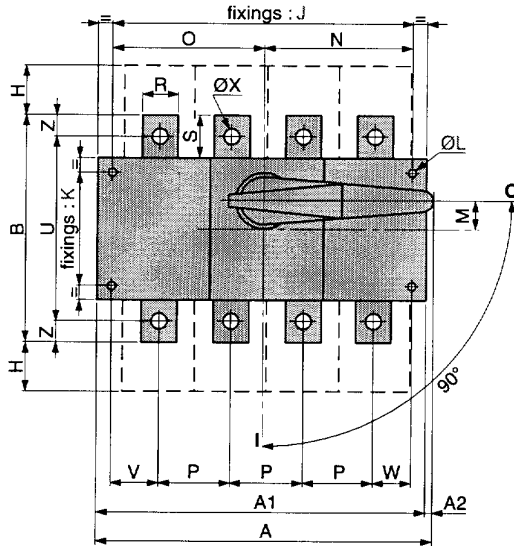

Direct operation

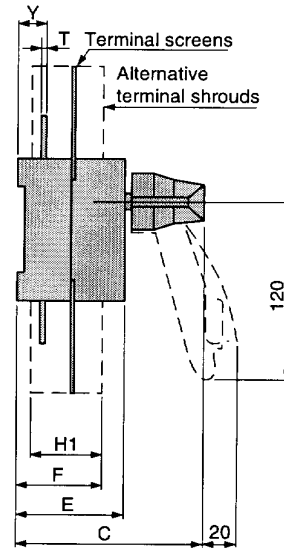

Door drilling

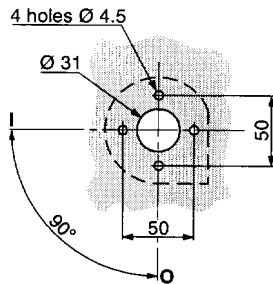

External operation

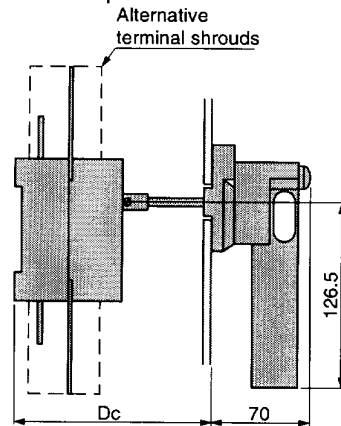

LK31-	Rating	A	A1	A2	B	C	Dc	E	F	H	H1	J	K	ØL
BC30	3 x 160 A	175	140	35	135	120	93-156	65	48.5	47.5	40	120	65	5.5
BC00	4 x 160 A	205	170	35	135	120	93-156	65	48.5	47.5	40	150	65	5.5
BG30	3 x 250 A	185	180	5	160	130	103-166	75	58.5	60	50	160	80	5.5
BG00	4 x 250 A	235	230	5	160	130	103-166	75	58.5	60	50	210	80	5.5
BJ30	3 x 315 A	230	230	-	235	165	138-200	110	83.5	82.5	75	210	140	7
BJ00	4 x 315 A	290	200	-	235	165	138-200	110	83.5	82.5	75	270	140	7
BN30	3 x 400 A	230	230	-	235	165	138-200	110	83.5	82.5	75	210	140	7
BN00	4 x 400 A	290	290	-	235	165	138-200	110	83.5	82.5	75	270	140	7
BS30	3 x 630 A	230	230	-	260	165	138-200	110	83.5	70	75	210	140	7
BS00	4 x 630 A	290	290	-	260	165	138-200	110	83.5	70	75	270	140	7

LK31-	Rating	M	N	O	P	R	S	T	U	V	W	ØX	Y	Z
BC30	3 x 160 A	15	75	45	36	20	25	3.5	115	28	20	9	20.5	10
BC00	4 x 160 A	15	75	75	36	20	25	3.5	115	22	20	9	20.5	10
BG30	3 x 250 A	20	105	55	50	25	30	3.5	130	33	27	11	22.5	15
BG00	4 x 250 A	20	105	105	50	25	30	3.5	130	33	27	11	22.5	15
BJ30	3 x 315 A	30	135	75	65	32	37.5	5	205	42.5	37.5	11	36	15
BJ00	4 x 315 A	30	135	135	65	32	37.5	5	205	37.5	37.5	11	36	15
BN30	3 x 400 A	30	135	75	65	32	37.5	5	205	42.5	37.5	11	36	15
BN00	4 x 400 A	30	135	135	65	32	37.5	5	205	37.5	37.5	11	36	15
BS30	3 x 630 A	30	135	75	65	40	50	6	220	42.5	37.5	13	36.5	20
BS00	4 x 630 A	30	135	135	65	40	50	6	220	37.5	37.5	13	36.5	20

Protection components

Load break switch-disconnectors, type LK3, 40 - 1250 A

Selection guide for 3 and 4-pole versions
Changeover and mechanically interlocked
switch-disconnectors (6 or 8-pole)

References :
pages 1/144 to 1/145

Direct operation

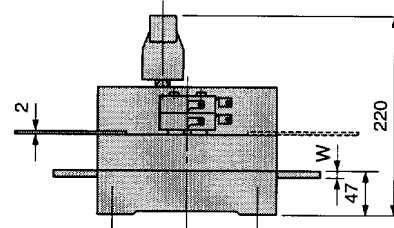
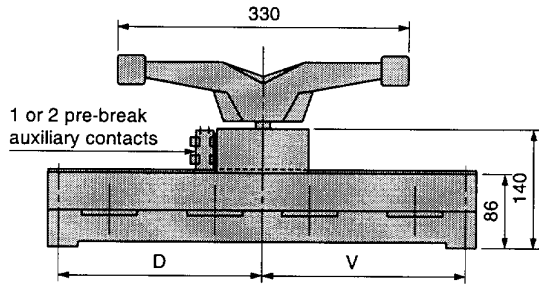

External operation

Switch-disconnector
base 212 ± 1 or
maximum of 412 mm
with shaft extension

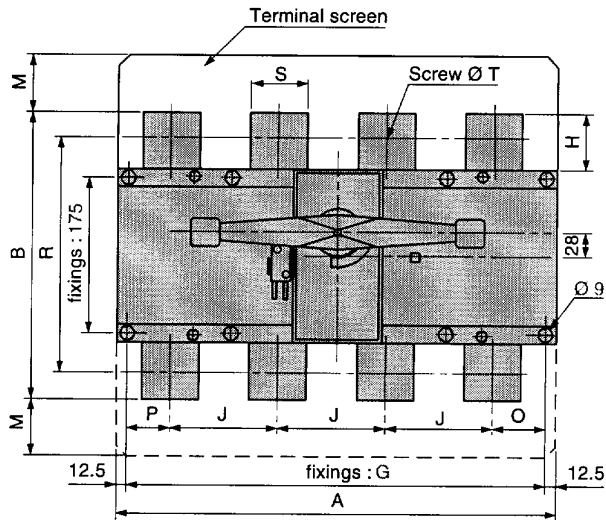
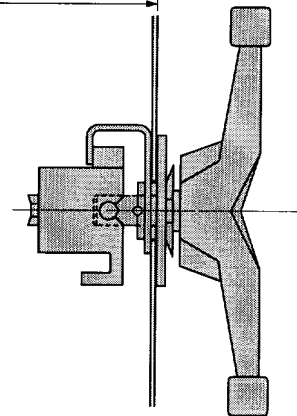

Door drilling

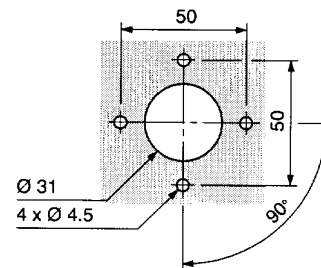

800 A terminal lugs

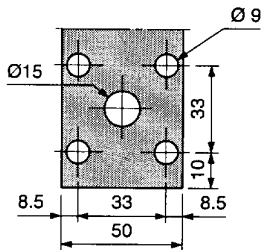

1250 A terminal lugs

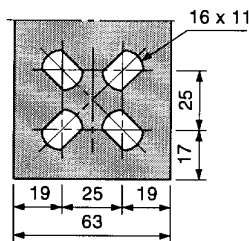

LK3-	Rating	A	B	C	G	H	J	M	O	P	R	S	U	V	W
BV30	3 x 800 A	280	320	127.5	255	60	80	70	47.5	47.5	267	50	47	127.5	6
BV40	4 x 800 A	360	320	167.5	335	60	80	70	47.5	47.5	267	50	47	167.5	6
CD30	3 x 1250 A	372	330	173.5	347	65	120	65	60.5	46.5	271	63	47	173.5	7
CD40	4 x 1250 A	492	330	233.5	467	65	120	65	60.5	46.5	271	63	47	233.5	7