

- Compact, modulated, self-contained convergent mode sensors for 10-30V dc operation
- Produces a precise 1.3 mm (0.05") diameter sensing spot at a focus point 16 mm (0.65") from the lens surface (model SM312CV) or a 3.0 mm (0.12") sensing spot at 43 mm (1.70") focus (model SM312CV2)
- Switch-selectable for light operate or dark operate
- Includes Banner's exclusive AID™ alignment system*
- Highly repeatable 1 millisecond response
- Both sourcing and sinking outputs (150 mA max. each); continuous overload and short-circuit protected
- Rugged, epoxy-encapsulated construction: meets NEMA standards 1, 2, 3, 3S, 4, 4X, 6, 12 and 13; IEC IP67
- Physically and electrically interchangeable with 18 mm barrel-type photoelectrics

*US patent number 4356393

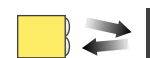

Visible red, 650 nm

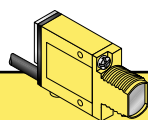

MINI-BEAM Convergent Mode Models

Models	Range	Cable	Supply Voltage	Output Type	Excess Gain	Beam Pattern
					Performance based on 90% reflectance white test card	
SM312CV SM312CVQD	16 mm (0.65 in) Spot Size at Focus: 1.3 mm (0.05 in)	2 m (6.5 ft) 4-Pin Euro QD	10-30V dc	Bipolar NPN/PNP		
SM312CV2 SM312CV2QD	43 mm (1.7 in) Spot Size at Focus: 3.0 mm (0.12 in)	2 m (6.5 ft) 4-Pin Euro QD	10-30V dc	Bipolar NPN/PNP		

For Standard MINI-BEAMS:

- 9 m (30 ft) cables are available by adding suffix "W/30" to the model number of any cabled sensor (e.g. - SM312CV W/30).
- A 150 mm (6 in.) long pigtail cable with attached QD connector is available by adding suffix "QDP" to the model number of any MINI-BEAM sensor (e.g. - SM312CVQDP). See page 5 for more information.
- A model with a QD connector requires an accessory mating cable. See page 8 for more information.
- May be ordered with 0.3 millisecond on/off response by adding suffix "MHS" to the model numbers (e.g. - SM312CVMHS). This modification reduces sensing range (and excess gain).

MINI-BEAM Installation and Alignment

Proper operation of the SM312CV or SM312CV2 sensor requires that it be mounted securely and aligned properly. In some applications, excessive movement or vibration can result in intermittent or false operation caused by loss of alignment. For best results, final-mount the sensor in an 18mm-hole by its threaded barrel or use a mounting bracket (see page 6).

Begin with the sensor at the approximate position where it will be mounted. With power applied to the circuit and with the sensor set for "light operate", direct the sensor's visible red spot at the object approximately 16 mm (0.65 in) (for model SM312CV) or 43 mm (1.7 in) (for model SM312CV2) directly in front of the lens. Move the sensor very slightly toward or away from the object while observing the red LED indicator on the back of the sensor. Note the near and far points at which sensing occurs (the range of distance over which the LED remains lit). Mount the sensor at a point approximately midway in the range. This should correspond to the point at which the red sensing spot on the object appears most sharply defined on the object surface. Mount the sensor at this position and distance.

*** Note regarding Light/Dark operate switch:**

- Turn switch *fully* clockwise for light operate (sensor outputs conduct when sensing light is received)
- Turn switch *fully* counterclockwise for dark operate (sensor outputs conduct when sensing light is not received)

CONVERGENT MODE ALIGNMENT

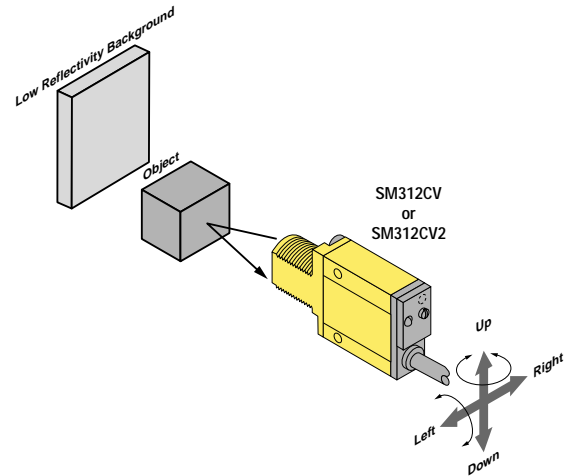

Distance from Sensor lens to object:
16 mm (0.65 in) for SM312CV
43 mm (1.7 in) for SM312CV2

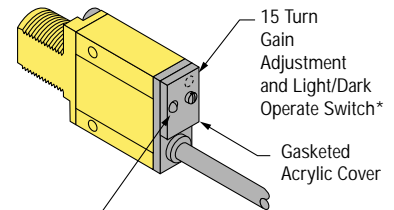

"AID" Indicator LED Lights when the sensor sees its own modulated light and pulses at a rate proportional to the strength of the received light signal.

MINI-BEAM DC Sensor Specifications	
Supply Voltage and Current	10 to 30V dc (10% maximum ripple) at less than 25 mA (exclusive of load)
Supply Protection Circuitry	Protected against reverse polarity and transient voltages
Output Configuration	Bipolar: One current sourcing (PNP) and one current sinking (NPN) open-collector transistor
Output Rating	150mA maximum each output at 25°C, derated to 100 mA at 70°C (derate ≈1 mA per °C) Off-state leakage current less than 1 microamp Output saturation voltage (PNP output) less than 1 volt at 10 mA and less than 2 volts at 150 mA Output saturation voltage (NPN output) less than 200 millivolts at 10 mA and less than 1 volt at 150 mA
Output Protection Circuitry	Protected against false pulse on power-up and continuous overload or short-circuit of outputs
Output Response Time	Sensors will respond to either a "light" or a "dark" signal of 1 millisecond or longer duration, 500 Hz max. 0.3 millisecond response modification is available. See note below. 100 millisecond delay on power-up: outputs do not conduct during this time.
Repeatability	0.3 milliseconds. Response time and repeatability specifications are independent of signal strength.
Adjustments	LIGHT/DARK OPERATE select switch, and 15-turn slotted brass screw GAIN (sensitivity) adjustment potentiometer (clutched at both ends of travel). Both controls are located on rear panel of sensor and protected by a gasketed, clear acrylic cover.
Indicators	Exclusive, patented Alignment Indicating Device system (AID™, US patent #4356393) lights a rear-panel mounted red LED indicator whenever the sensor sees a "light" condition, with a superimposed pulse rate proportional to the light signal strength (the stronger the signal, the faster the pulse rate).
Construction	Reinforced PBT thermoplastic polyester housing, totally encapsulated, o-ring sealing, acrylic lenses, and stainless steel screws.
Environmental Rating	Meets NEMA standards 1, 2, 3, 3S, 4, 4X, 6, 12, and 13; IEC IP67
Connections	PVC-jacketed 4-conductor 2 m (6.5 ft) or 9 m (30 ft) cables, or 4-pin euro-style quick disconnect (QD) fitting are available. QD cables are ordered separately. See page 5.
Operating Temperature	Temperature: -20° to +70°C (-4° to +158°F) Maximum relative humidity: 90% at 50°C (non-condensing)
Application Notes	The NPN (current sinking) output of dc MINI-BEAM sensors is directly compatible as an input to Banner logic modules, including all non-amplified MAXI-AMP and MICRO-AMP modules. MINI-BEAMs are TTL compatible.
Certifications	

NOTE: DC MINI-BEAMs may be ordered with 0.3 millisecond on/off response by adding suffix "MHS" to the model numbers (e.g. - SM312CVMHS). This modification reduces sensing range (and excess gain).

MINI-BEAM DC Hookup Diagrams

DC Sensors with Attached Cable

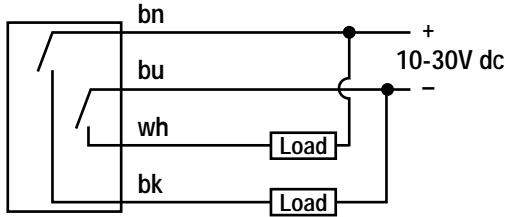

DC Sensors with Quick Disconnect (4-Pin Euro-Style)

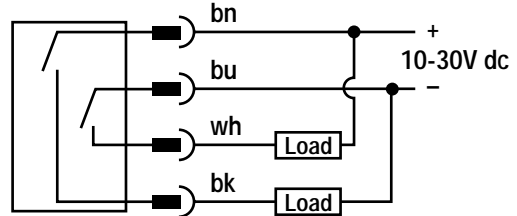

4-Pin Euro-Style Pin-out (Cable Connector Shown)

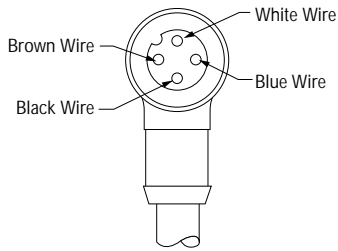

Quick Disconnect (QD) Option

DC MINI-BEAM sensors are sold with either a 2 m (6.5 ft) or a 9 m (30 ft) attached PVC-covered cable, or with a 4-pin euro-style QD cable fitting.

DC QD sensors are identified by the letters "QD" in their model number suffix. For more information on mating QD cables, see page 5.

MINI-BEAM Dimension Information

MINI-BEAM DC Sensor with Integral Cable

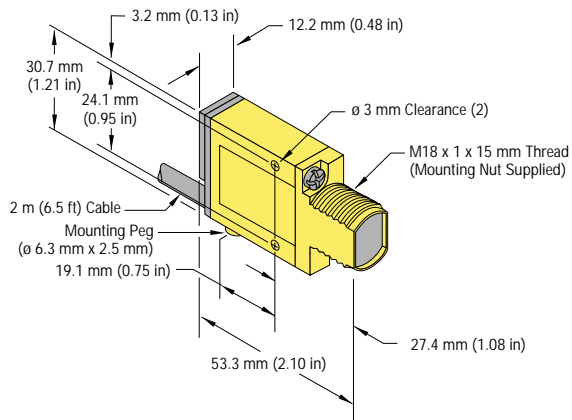

MINI-BEAM DC Sensor with Quick-Disconnect

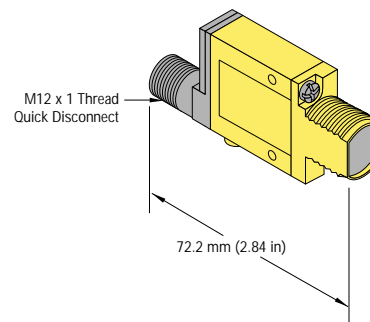

MINI-BEAM MODIFICATIONS			
Model Suffix	Modification	Description	Example of Model Number
W/30	9 meter (30 ft) cable	All MINI-BEAM sensors may be ordered with an integral 9 m (30 ft) cable in place of the standard 2 m (6.5 ft) cable	SM312CV W/30
MHS	Modified for High Speed	Standard dc MINI-BEAM sensors with 1 millisecond output response may be modified for 0.3 millisecond (300 μs) response. NOTE: Faster response comes at the expense of lower excess gain. Also, operating temperature range becomes -20° to +50°C (-4° to +122°F)	SM312CVMHS
QDP	Pigtail Quick Disconnect	All MINI-BEAMS may be built with a 150 mm (6 in) long integral cable which is terminated with the appropriate QD connector.	SM312CVQDP



Replacement Lens Assemblies		
MINI-BEAM lens assemblies are field-replaceable.		
Model	Description	
UC-300C.7	Replacement lens for CV	
UC-300C2	Replacement lens for CV2	

Euro-Style Quick Disconnect Cables				
<p>Cable: PVC jacket, polyurethane connector body, nickel-plated brass coupling nut Conductors: 22 or 20 AWG high-flex stranded, PVC insulation, gold-plated contacts Temperature: -40 to +90°C (-40 to +194°F) Voltage Rating: 250V ac/300V dc</p>				
Style	Model	Length	Dimensions:	Pin-out
4-Pin Straight	MQDC-406 MQDC-415 MQDC-430	2 m (6.5 ft) 5 m (15 ft) 9 m (30 ft)		
4-Pin Right-angle	MQDC-406RA MQDC-415RA MQDC-430RA	2 m (6.5 ft) 5 m (15 ft) 9 m (30 ft)		

MINI-BEAM® Sensors SM312CV and SM312CV2







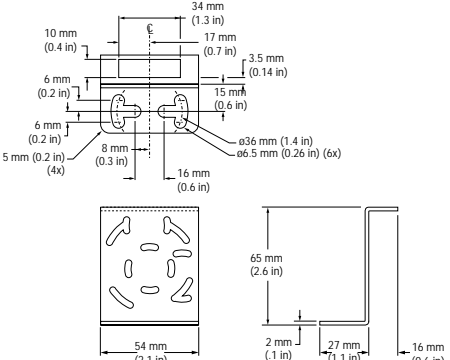

Extension Cables (without connectors)

The following cables are available for extending the length of existing sensor cable. These are 30 m (100 ft) lengths of MINI-BEAM cable. This cable may be spliced to existing cable. Connectors, if used, must be customer-supplied.

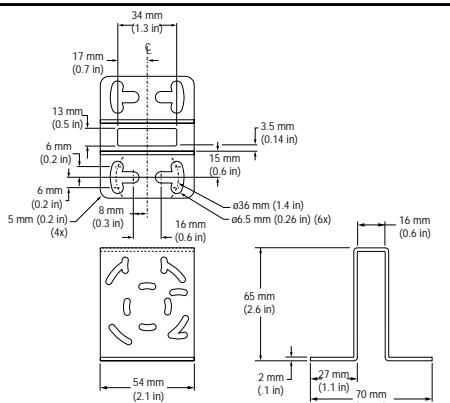
Model	Type	Used with:
EC312-100	4-conductor	All MINI-BEAM SM312 dc models

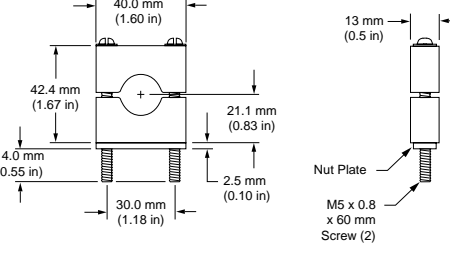
Mounting Brackets

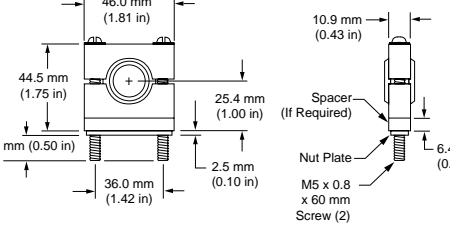
Model	Description		
SMB312S	Stainless steel 2-axis, side mounting bracket		
SMB312PD	Stainless steel 18 mm barrel-mounting bracket		
SMB312B	Stainless steel 2-axis, bottom mounting bracket		
SMB46L	<ul style="list-style-type: none"> "L" bracket 14 ga 316 stainless steel 		

Mounting Brackets		
Model	Description	Dimensions
SMB46S	<ul style="list-style-type: none"> • "S" bracket • 14 ga 316 stainless steel 	 
SMB46U	<ul style="list-style-type: none"> • "U" bracket • 14 ga 316 stainless steel 	 
SMB18C	<ul style="list-style-type: none"> • 18 mm split clamp black VALOX® bracket • Stainless steel mounting hardware included 	 
SMB18S	<ul style="list-style-type: none"> • 18 mm swivel, black VALOX® bracket • Stainless steel mounting hardware included 	 

MINI-BEAM[®] Sensors SM312CV and SM312CV2



WARNING . . . Not To Be Used for Personnel Protection

Never use this product as a sensing device for personnel protection. Doing so could lead to serious injury or death.

This product does NOT include the self-checking redundant circuitry necessary to allow its use in personnel safety applications. A sensor failure or malfunction can cause either an energized or de-energized sensor output condition. Consult your current Banner Safety Products catalog for safety products which meet OSHA, ANSI and IEC standards for personnel protection.

WARRANTY: Banner Engineering Corp. warrants its products to be free from defects for one year. Banner Engineering Corp. will repair or replace, free of charge, any product of its manufacture found to be defective at the time it is returned to the factory during the warranty period. This warranty does not cover damage or liability for the improper application of Banner products. This warranty is in lieu of any other warranty either expressed or implied.