

AkroBins®



- Control inventories, shorten assembly times, and minimize parts handling.
- Heavy-duty bins securely stack atop each other, sit on shelving, and hang from Akro-Mils racks, panels, rails, and carts.
- Molded of high-density polypropylene, AkroBins are unaffected by weak acids and alkalis.
- Sturdy, one-piece construction is water, rust, and corrosion-proof.
- Guaranteed not to crack or break under normal load conditions as stated in our 1-year limited warranty.
- Autoclavable up to 250° F.
- Available in 12 sizes and 4 colors: Red, Yellow, Blue, and Stone.



Anti-slide stop prevents stacked bins from shifting forward

Full-width hanger lip supports bin on hanging system



Curved-bottom hopper front makes it easy to retrieve small parts

Large front label slot allows larger bar code scanning

Extra-wide stacking edge saves space and prevents spills

Reinforced side ribs add strength & prevent spreading when stacked

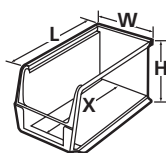

30270



30235

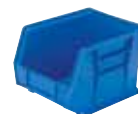

30239



30230



30210

AkroBins

Model No.	Outside Dimensions						Inside Dimensions								Bin Load Capacity On Rack**	Ctn. Qty.
	Inches			mm			Inches				mm					
	L	W	H	L	W	H	L	W	H	X	L	W	H	X		
30210	5 ³ / ₈	4 ¹ / ₈	3	137	105	76	4 ³ / ₈	3 ⁷ / ₁₆	2 ¹ / ₁₆	4	120	87	71	102	10 lbs.	24
30220	7 ³ / ₈	4 ¹ / ₈	3	187	105	76	6 ³ / ₈	3 ⁷ / ₁₆	2 ¹ / ₁₆	6	171	87	71	152	10 lbs.	24
30224	10 ⁷ / ₈	4 ¹ / ₈	4	276	105	102	10 ¹ / ₄	3 ³ / ₁₆	3 ³ / ₈	9	260	87	95	229	30 lbs.	12
30230	10 ⁷ / ₈	5 ¹ / ₂	5	276	140	127	10 ¹ / ₄	4 ³ / ₈	4 ³ / ₈	9	260	111	121	229	30 lbs.	12
30234	14 ³ / ₈	5 ¹ / ₂	5	375	140	127	14 ¹ / ₁₆	4 ³ / ₈	4 ³ / ₈	12 ¹³ / ₁₆	357	111	121	325	50 lbs.	12
30235	10 ⁷ / ₈	11	5	276	279	127	10 ¹ / ₄	10	4 ³ / ₈	9	260	254	121	229	50 lbs.	6
30239	10 ³ / ₈	8 ¹ / ₄	7	273	210	178	10	6 ⁹ / ₁₆	6 ³ / ₈	8	254	167	171	203	50 lbs.	6
30240	14 ³ / ₈	8 ¹ / ₄	7	375	210	178	14	6 ⁹ / ₁₆	6 ³ / ₈	12	356	167	171	305	60 lbs.	12
30250	14 ³ / ₈	16 ¹ / ₂	7	375	419	178	14	14 ³ / ₈	6 ³ / ₈	12	356	375	171	305	75 lbs.	6
30255	10 ⁷ / ₈	16 ¹ / ₂	5	276	419	127	9 ³ / ₈	15	4 ³ / ₈	8 ¹ / ₂	248	381	121	216	60 lbs.	6
30265*	18	8 ¹ / ₄	9	457	210	229	17 ¹ / ₈	6 ³ / ₈	8 ¹ / ₄	14 ¹ / ₂	435	171	210	368	N/A	6
30270*	18	16 ¹ / ₂	11	457	419	279	17 ¹ / ₈	14 ³ / ₈	10 ¹ / ₄	13 ³ / ₄	435	375	260	349	N/A	3

One color per carton: Specify Red, Blue, Yellow, or Stone.

*Note 30265 and 30270 are not designed for use with hanging systems.

** CAUTION: When using bins with hanging systems, do not exceed the weight capacity for the rack which may be less than the total sum of bin capacities.

When compared to the competition, AkroBins:

- Support more weight when stacked.
- Handle more abuse.
- Hold more weight without cracking.



Accessories:

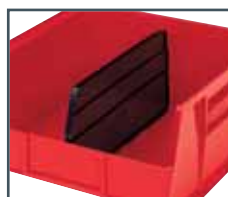

Dividers
Lengthwise dividers keep items separated in the bin.



Bin Lids*
"See-through" crystal styrene lids keep contents dust-free and protected.

Dividers

Model No.	Fits AkroBins	Pkg. Qty.
40210	30210 (1)	6
40220	30220 (1)	6
40230	30230 (1), 30235 (3)	6
40239	30239 (1)	6
40245	30240 (1), 30250 (1)	6
40265	30265 (1)	6
40270	30270 (3)	6

(Max. # of dividers)

*30224, 30255, 30234 no dividers available.

Bin Lids

Model No.	Fits AkroBins	Ctn. Qty.
30211	30210	24
30221	30220	24
30231	30230	12
30236	30235	6

*Assembly required – hinge pins included.

Super-Size AkroBins & Dollies

New!

Available in 5 sizes and 3 colors: Red, Yellow, and Blue.



30280



30281



30282



30283



30290



AkroBin solid steel Dollies (Model No. RU842HR2018 & RU842HR2918) are available for efficient parts transport.

- Control inventories, shorten assembly times, and minimize parts handling.
- Heavy-duty bins securely stack atop each other, or sit on shelving.
- Molded of high-density polypropylene, AkroBins are unaffected by weak acids and alkalis.
- Sturdy, one-piece construction is water, rust, and corrosion-proof.
- Guaranteed not to crack or break under normal load conditions as stated in our 1-year limited warranty.
- Autoclavable up to 250° F.



Extra-wide stacking ledge saves space and prevents spills

AkroBins can be used alone or stacked together for high-density storage



Easy to carry with large handle molded onto back of bin

Anti-slide stop prevents stacked bins from shifting forward

Large label area on front of bin

Curved-bottom hopper front makes it easy to retrieve small parts

Reinforced side ribs add strength and prevent spreading when stacked

Super-Sized AkroBins

Model No.	Outside Dimensions						Inside Dimensions						Max. Capacity Per Bin	Stacking Capacity /=Qty. Stacked	Ctn. Qty.		
	Inches			mm			Inches			mm							
	L	W	H	L	W	H	L	W	H	X	L	W	H	X			
30280	20	12 ³ / ₈	6	508	314	152	16 ⁷ / ₈	10 ¹ / ₁₆	5 ³ / ₈	15 ¹ / ₂	429	271	137	394	100lbs.	40lb./10	4
30281	20	12 ³ / ₈	8	508	314	203	16 ⁷ / ₈	10 ¹ / ₁₆	7 ³ / ₈	15 ¹ / ₂	429	271	187	394	150lbs.	50lb./7	3
30282	20	12 ³ / ₈	12	508	314	305	16 ⁷ / ₈	10 ¹ / ₁₆	11 ³ / ₈	15 ¹ / ₂	429	271	289	394	200lbs.	60lb./5	2
30283	20	18 ³ / ₈	12	508	467	305	16 ⁷ / ₈	16 ⁹ / ₁₆	11 ³ / ₈	15 ¹ / ₂	429	421	289	394	300lbs.	150lb./5	1
30290	29 ¹ / ₄	18 ³ / ₈	12	743	467	305	26 ¹ / ₈	16 ⁹ / ₁₆	11 ³ / ₈	24 ³ / ₄	664	421	289	629	300lbs.	150lb./5	1

One color per carton: Specify Red, Blue, or Yellow. Not recommended to hang on rack or panel systems.

Dollies

Model No.	Dimensions			Ctn. Qty.	Capacity Lbs.	Casters
	L	W	H			
RU842HR2018	20"	18 ³ / ₈ "	3 ¹ / ₂ "	1	500	2" Polyolefin
RU842HR2918	29 ¹ / ₄ "	18 ³ / ₈ "	3 ¹ / ₂ "	1	500	2" Polyolefin

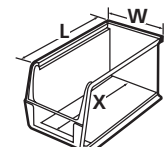

Stak-N-Store Bins



- The perfect way to organize heavy, bulky items.
- Bins stack to form tall, stable storage arrangements on floors or standard industrial shelving.
- 75 lb. weight capacity.
- Color: Gray, Red, Blue.



Small Stak-N-Store bins (13014) fit 3 across on standard 36" shelving
 Medium Stak-N-Store bins (13018) fit 2 across on standard 36" shelving.
 See Shelving Systems on page 11.

Large comfort grip handles

Large radius corners and a curved upper lip add strength

Side ribs insure stability when stacked

Wide-hopper front allows easy access to bulky items



Stack bins together to form a storage system.



13014



13018



13017

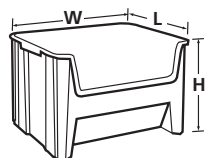

Stak-N-Store Bins

Model No.	Outside Dimension						Capacity Cu. Ft.	Ctn. Qty.
	Inches			mm				
	L	W	H	L	W	H		
13014	17½	10⅞	12½	445	276	318	.98	4
13017	15¼	19⅞	12⅞	387	505	316	1.7	3
13018	17½	16½	12½	445	419	318	1.6	2

Order in carton quantities.

Shelf Bins



Shelf bins tilt out for complete access to contents.

- Shelf Bins outlast corrugated bins – paying for themselves in reduced replacement costs.
- Superior construction allows Shelf Bins to be fully loaded without bulging or cracking.
- Durable polypropylene bins provide an attractive, neat appearance.
- Works with 12", 18", and 24" deep shelving, or vertical storage and retrieval units.
- One-piece construction is waterproof and unaffected by grease or oil.
- Available in 13 sizes and 3 colors: Red, Yellow, and Blue.

Wide hopper front allows easy access

Built-in rear hanglock allows bin to tilt out for complete access

Molded-in label holder identifies contents

Optional dividers increase versatility

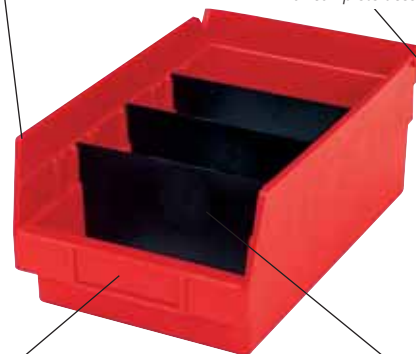

30120

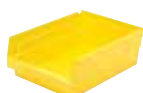

30150



30158

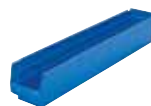

30124



30164

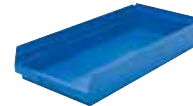

30174

Shelf Bins

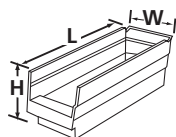

Model No.	Outside Dimension						Inside Dimension						Ctn Qty.	Cups Per Bin		Optional Divider
	Inches			mm			Inches			mm				Small 30101	Large 30102	
12" Shelf Bin																
30110	11 ⁵ / ₈	2 ³ / ₄	4	295	70	102	10 ¹ / ₄	1 ⁵ / ₈	4	260	41	102	24	3	-	None
30120	11 ⁵ / ₈	4 ¹ / ₈	4	295	105	102	10 ¹ / ₄	3	4	260	76	102	24	5	2	40120
30130	11 ⁵ / ₈	6 ³ / ₈	4	295	168	102	10 ¹ / ₄	5 ¹ / ₂	4	260	140	102	12	9	4	40130
30150	11 ⁵ / ₈	8 ³ / ₈	4	295	219	102	10 ¹ / ₄	7 ⁷ / ₈	4	260	181	102	12	11	4	40150
30170	11 ⁵ / ₈	11 ¹ / ₈	4	295	283	102	10 ¹ / ₄	10	4	260	254	102	12	15	6	40170
18" Shelf Bin																
30128	17 ⁷ / ₈	4 ¹ / ₈	4	454	105	102	16 ¹ / ₂	3	4	419	76	102	12	8	3	40120
30138	17 ⁷ / ₈	6 ⁵ / ₈	4	454	168	102	16 ¹ / ₂	5 ¹ / ₂	4	419	140	102	12	15	6	40130
30158	17 ⁷ / ₈	8 ³ / ₈	4	454	213	102	16 ¹ / ₂	7 ¹ / ₈	4	419	181	102	12	15	6	40150
30178	17 ⁷ / ₈	11 ¹ / ₈	4	454	283	102	16 ¹ / ₂	10	4	419	254	102	12	25	12	40170
24" Shelf Bin																
30124	23 ⁵ / ₈	4 ¹ / ₈	4	600	105	102	22 ¹ / ₈	3	4	562	76	102	12	11	4	40120
30164	23 ⁵ / ₈	6 ³ / ₈	4	600	168	102	22 ¹ / ₈	5 ¹ / ₂	4	562	140	102	6	21	8	40130
30184	23 ⁵ / ₈	8 ³ / ₈	4	600	213	102	22 ¹ / ₈	7 ⁷ / ₈	4	562	181	102	6	25	8	40150
30174	23 ⁵ / ₈	11 ¹ / ₈	4	600	283	102	22 ¹ / ₈	10	4	562	254	102	6	35	16	40170

One color per carton. Specify color: Red, Yellow, or Blue.

Optional Accessories:

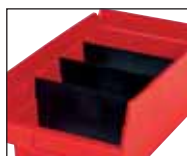

Dividers

Black polypropylene dividers create compartments. Sizes to fit all bins except 30110. Each bin accepts up to 7 compartment dividers.

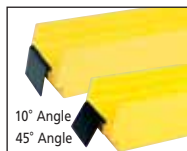

Extended Label Holders

Designed for larger bar code scanning. Label holders fit all shelf bins except the 30110.

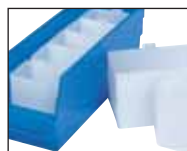

Bin Cups

Bin Cups lift out easily for parts retrieval and fit all Shelf Bins. (Refer to Shelf Bin chart for number of cups per bin.)

Dividers

Model No.	Fits Shelf Bins	Width	Pkg. Qty.
40120	30120, 30124, 30128	4 ¹ / ₈ "	24
40130	30130, 30138, 30164	6 ⁵ / ₈ "	24
40150	30150, 30158, 30184	8 ³ / ₈ "	24
40170	30170, 30174, 30178	11 ¹ / ₈ "	24

Extended Label Holders

Model No.	Description	Dimensions		Pkg. Qty.
		W	H	
40410	10° Angle	4"	2 ¹ / ₄ "	24
40445	45° Angle	4"	2 ¹ / ₄ "	24

Bin Cups

Model No.	Description	Dimensions			Ctn. Qty.
		L	W	H	
30101	Small Bin Cup	3 ¹ / ₄ "	2"	3"	48
30102	Large Bin Cup	5"	2 ³ / ₄ "	3"	24

Economy Bins



A large bar code label area make content identification simple.

- The only small parts bin that can nest and stack.
- Help organize work areas and expand storage space without adding shelving.
- Versatile Economy Bins make full use of shelf depth on 12" or 18" deep shelving and stack to fill space between shelves.
- Sturdy one-piece construction is water, rust, and corrosion-proof.
- Unaffected by weak acids and alkalis.
- Molded from co-polymer polypropylene.
- Guaranteed not to crack or break under normal load conditions as stated in our 1-year limited warranty.
- Autoclavable up to 250° F
- Available in 5 sizes.

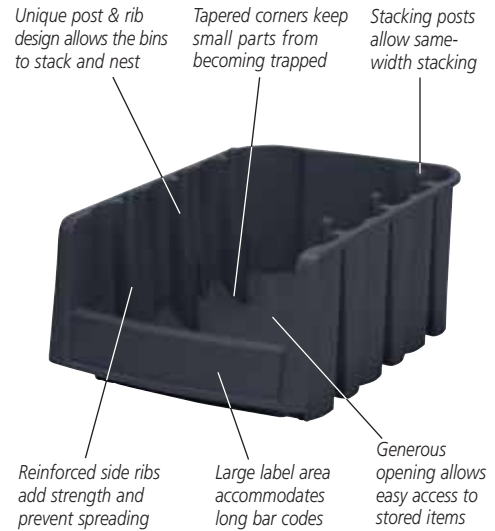

30796 Black



30716 Black



30776 Black



30718 Black



30778 Black

Economy Bins

Model No.	Outside Dimensions						Ctn. Qty.
	Inches			mm			
	L	W	H	L	W	H	
30796 Black	8 $\frac{1}{8}$	6 $\frac{5}{8}$	5	225	168	127	10 each
30716 Black	11 $\frac{7}{8}$	6 $\frac{5}{8}$	5	302	168	127	10 each
30776 Black	17 $\frac{7}{8}$	6 $\frac{5}{8}$	7	454	168	178	10 each
30718 Black	11 $\frac{7}{8}$	8 $\frac{3}{8}$	5	302	213	127	8 each
30778 Black	17 $\frac{7}{8}$	8 $\frac{3}{8}$	7	454	213	178	8 each

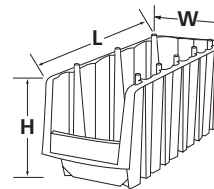

1800 Series AkroBins®



30358

- Storage systems for large, heavy, and bulky items.
- Concentrate storage, reduce and control inventories, minimize material handling, and organize supplies.
- Strong, durable co-polymer polypropylene construction.
- Designed to fit on 18" shelving for concentrated storage.
- One black cross-wise divider included per bin.
- Available in 2 sizes: 8 $\frac{1}{4}$ " and 11" width.
- Color: Beige.

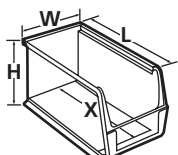
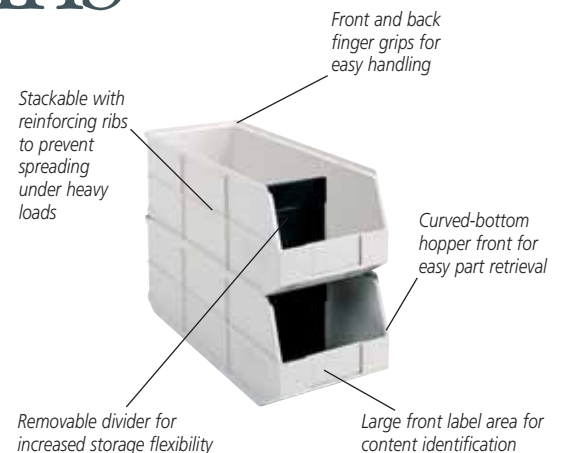

1800 Series AkroBins

Model No.	Outside Dimensions						Inside Dimensions						Ctn. Qty.	Dividers Model No.	Pkg. Qty.	Capacity Lbs.		
	Inches			mm			Inches			mm								
	L	W	H	L	W	H	L	W	H	X	L	W	H	X				
30348	20 $\frac{1}{2}$	8 $\frac{1}{4}$	7	521	210	178	20	7 $\frac{3}{8}$	6 $\frac{1}{2}$	20	508	187	165	508	6	40348	6	60
30358	20 $\frac{1}{2}$	11	7	521	279	178	20	10 $\frac{1}{8}$	6 $\frac{1}{2}$	20	508	257	165	508	6	40358	6	75

Order in carton quantities.

ESD Containers

AkroBins®

- Akro-Mils ESD containers dissipate electrostatic charges which can severely damage sensitive electronic components.
- Sturdy, one-piece construction is water, rust, and corrosion proof, and heat resistant to 300°F.



Hanging Systems

- Storage systems provide convenient parts storage and retrieval.
- Six options let you choose the system that works best for you.



Shelf Bins

- Shelf Bins provide an economical solution to electronic component storage problems.
- Works with 12", 18", and 24" deep shelving or vertical storage and retrieval units.

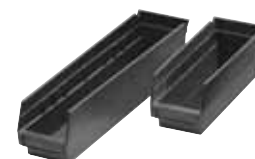

Grids

- Grids are compatible with most racks, shelving, and automated material handling equipment.
- Ribbed design gives added strength.



ESD AkroBins (Black Only)

Model No.	Outside Dimensions						Inside Dimensions						Bin Load Capacity On Rack	Ctn Qty.
	Inches			mm			Inches			mm				
	L	W	H	L	W	H	L	W	H	X	L	W	H	X
30210ESD	5 $\frac{3}{8}$	4 $\frac{1}{8}$	3	136	105	76	4 $\frac{3}{4}$	3 $\frac{7}{16}$	2 $\frac{1}{16}$	4	121	87	71	102
30220ESD	7 $\frac{3}{8}$	4 $\frac{1}{8}$	3	187	105	76	6 $\frac{3}{4}$	3 $\frac{7}{16}$	2 $\frac{1}{16}$	6	171	87	71	152
30230ESD	10 $\frac{7}{8}$	5 $\frac{1}{2}$	5	276	140	127	10 $\frac{1}{4}$	4 $\frac{3}{8}$	4 $\frac{3}{4}$	9	260	111	121	229
30235ESD	10 $\frac{7}{8}$	11	5	276	279	127	10 $\frac{1}{4}$	10	4 $\frac{3}{4}$	9	260	254	121	229
30240ESD	14 $\frac{3}{4}$	8 $\frac{1}{4}$	7	375	210	178	14	6 $\frac{9}{16}$	6 $\frac{3}{4}$	12	356	167	171	305

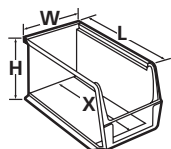

Louvered Panels And Bench Racks

Use this chart to determine the quantity of same-size AkroBins required to fill each panel.

See pages 5-6 for hanging system features.

Model No.	Description	Ctn. Qty.	AkroBin Model No. (Bin Wt. Capacity)				
			30210ESD (10 lbs.)	30220ESD (10 lbs.)	30230ESD (30 lbs.)	30235ESD (50 lbs.)	30240ESD (60 lbs.)
30618	18" x 19" Louvered Panel	4	16	16	9	-	-
30636	35 $\frac{3}{4}$ " x 19" Louvered Panel	4	32	32	18	9	8
98600	27 $\frac{3}{4}$ " Bench Rack	1	30	30	12	6	6
98636	36" Bench Rack	1	40	40	18	9	8



Grounding wire 98100 – Conducts static charges away from the storage system. Designed to convert existing Akro-Mils racks and hanging systems (see pages 5-6).

Louvered Floor Racks

Use this chart to determine the quantity of same-size AkroBins required to fill each floor rack.

Bins sold separately.

Model No.	Description	Dimensions			AkroBin Model Number							
		Inches		mm	30210ESD	30220ESD	30230ESD	30235ESD	30240ESD			
		L	W	H	L	W	H					
30626	Double-Sided Snap Fastener Louvered Rack	36	20	60	914	508	1524	192	192	108	54	48
30653	Louvered Floor Rack	35 $\frac{3}{4}$	32	75 $\frac{1}{8}$	908	813	1908	288	288	144	72	72

ESD Shelf Bins

Model No.	Outside Dimension						Inside Dimension						Ctn Qty.
	Inches			mm			Inches			mm			
	L	W	H	L	W	H	L	W	H	L	W	H	
30120ESD	11 $\frac{1}{8}$	4 $\frac{1}{8}$	4	295	105	102	10 $\frac{1}{4}$	3	4	260	76	102	24
30128ESD	17 $\frac{7}{8}$	4 $\frac{1}{8}$	4	454	105	102	16 $\frac{1}{2}$	3	4	419	76	102	12
30124ESD	23 $\frac{3}{8}$	4 $\frac{1}{8}$	4	600	105	102	22 $\frac{1}{2}$	3	4	562	76	102	12

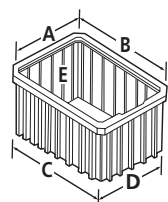
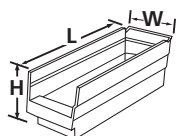

ESD Grids

Model No.	Outside Dimensions						Inside Dimensions									Ctn. Qty.
	Inches			mm			Inches					mm				
	L	W	H	L	W	H	A	B	C	D	E	A	B	C	D	E
33164ESD	16 $\frac{1}{2}$	10 $\frac{7}{8}$	4	419	276	102	9 $\frac{3}{8}$	14 $\frac{15}{16}$	14 $\frac{13}{16}$	9 $\frac{3}{16}$	3 $\frac{7}{8}$	238	379	376	233	98
33224ESD	22 $\frac{3}{8}$	17 $\frac{3}{8}$	4	568	441	102	15 $\frac{1}{16}$	20 $\frac{1}{16}$	20	15	3 $\frac{7}{8}$	383	510	508	381	98