



# WORLD BEAM® QS18LD Series

Miniature Diffuse-Mode Laser Sensors

## Features



- Visible Class 1 laser for diffuse sensing
- Narrow effective beam provides small-object detection and precise position control
- Crosstalk rejection algorithm protects against optical disturbance from adjacent sensors
- Excellent optical performance throughout sensing range, even close up
- 10 to 30V dc operation, with complementary (SPDT) NPN or PNP outputs, depending on model
- Bright LED operating status indicators are visible from 360°
- Compact, rugged sealed housing, protected circuitry
- Mounting versatility – popular 18 mm threaded barrel or side-mount
- Choose 2 m (6.5') or 9 m (30') cable or one of four QD options

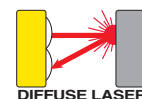

## Models

Model	Sensing Beam and Range	Spot Size at Focus	Cable*	Output	Excess Gain	Beam Pattern
					Performance based on 90% reflectance white test card	
QS18VN6LD	650 nm Visible Red, Class 1 Laser 300 mm (12")	Approx. 1 mm at 300 mm (0.039" at 12")	4-wire, 2 m (6.5') integral cable	NPN		
QS18VP6LD				PNP		

\*Only standard 2m (6.5') cable models are listed. For 9 m (30') cable, add suffix "W/30" to the model number (e.g., QS18VN6LD W/30).

**QD models:**

- For 4-pin integral Euro-style QD, add suffix "Q8" (e.g., QS18VN6LDQ8).
  - For 4-pin integral Pico-style QD, add suffix "Q7" (e.g., QS18VN6LDQ7).
  - For 4-pin Euro-style 150 mm (6") pigtail QD, add suffix "Q5" (e.g., QS18VN6LDQ5).
  - For 4-pin Pico-style 150 mm (6") pigtail QD, add suffix "Q" (e.g., QS18VN6LDQ).
- A model with a QD connector requires a mating cordset (see page 3).

**⚠ WARNING . . . Not To Be Used for Personnel Protection**

Never use these products as sensing devices for personnel protection. Doing so could lead to serious injury or death.

These sensors do NOT include the self-checking redundant circuitry necessary to allow their use in personnel safety applications. A sensor failure or malfunction can cause either an energized or de-energized sensor output condition. Consult your current Banner Safety Products catalog for safety products which meet OSHA, ANSI and IEC standards for personnel protection.



# WORLD BEAM® QS18LD Series

## Specifications

<b>Supply Voltage</b>	10 to 30V dc (10% maximum ripple) at less than 15 mA, exclusive of load; Protected against reverse polarity and transient voltages
<b>Sensing Beam (Laser Characteristics)</b>	<b>Wavelength:</b> 650 nm visible red Class 1 laser <b>Pulse Width:</b> 7 microseconds <b>Rep Rate:</b> 130 microseconds <b>Average Output Power:</b> 0.065 milliwatts
<b>Output Configuration</b>	<b>Solid-state complementary (SPDT);</b> NPN or PNP (current sinking or sourcing), depending on model; <b>Rating:</b> 100 mA maximum each output at 25°C <b>Off-state leakage current:</b> <b>NPN:</b> less than 200 µA @ 30V dc (See Application Note 1) <b>PNP:</b> less than 10 µA @ 30V dc <b>ON-state saturation voltage:</b> <b>NPN:</b> less than 1.6V @ 100 mA <b>PNP:</b> less than 3.0V @ 100 mA Protected against false pulse on power-up and continuous overload or short circuit of outputs
<b>Output Response</b>	700 microseconds ON/OFF NOTE: 200 ms max. delay on power-up; outputs do not conduct during this time
<b>Repeatability</b>	130 microseconds
<b>Hysteresis</b>	15% of range typical
<b>Adjustments</b>	Single-turn sensitivity (Gain) adjustment potentiometer
<b>Indicators</b>	2 LED indicators on sensor top: <b>Green ON steady:</b> Power ON <b>Yellow ON steady:</b> Light sensed <b>Yellow flashing:</b> Marginal excess gain (1.0 to 1.5x excess gain)
<b>Construction</b>	ABS housing, acrylic lens cover; 3 mm mounting hardware included
<b>Environmental Ratings</b>	Rated IEC IP67; NEMA 6; UL Type 1
<b>Connections</b>	2 m (6.5') 4-wire PVC cable                      4-pin Pico-style QD                      4-pin Euro-style QD 9 m (30') 4-wire PVC cable                      4-pin Pico-style 150 mm (6") pigtail QD                      4-pin Euro-style 150 mm (6") pigtail QD
<b>Operating Conditions</b>	<b>Temperature:</b> -10° to +50° C (+14° to +122° F) <b>Relative Humidity:</b> 90% @ 50° C (non-condensing)
<b>Laser Classification</b>	Class 1 laser product; complies with IEC 60825-1:2001 and 21 CFR 1040.10, except for deviations pursuant to Laser Notice 50, dated 7-26-01
<b>Application Notes</b>	1. NPN off-state leakage current is < 200 µA for load resistances > 3 kΩ or optically isolated loads. For load current of 100 mA, leakage is < 1% of load current
<b>Certifications</b>	

## Description of Laser Class

### Class 1

Lasers that are safe under reasonably foreseeable conditions of operation, including the use of optical instruments for intrabeam viewing.

Reference IEC 60825-1:2001, section 8.2.

### Class 1 Laser Characteristics

(see specifications above)

### For Safe Laser Use:

- Do not permit a person to stare at the laser from within the beam.
- Do not point the laser at a person's eye at close range.
- Locate open laser beam paths either above or below eye level, where practical.



### CAUTION . . . Do Not Disassemble for Repair

Use of controls or adjustments or performance of procedures other than those specified herein may result in hazardous radiation exposure. **Do NOT attempt to disassemble this sensor for repair.** A defective unit must be returned to the manufacturer.

# WORLD BEAM® QS18LD Series

## Dimensions and Features

### Cabled Models

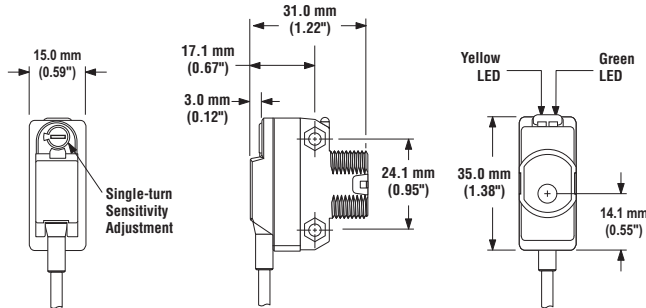

### QD Models

#### Model Suffix Q

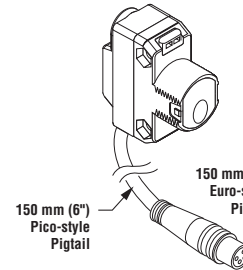

#### Model Suffix Q5

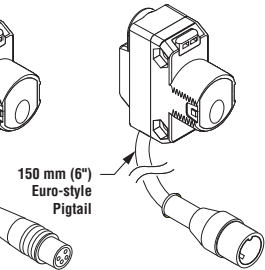

### Mounting Hardware (included)

#### Packing List:

- Sensor
- M18 x 1 jam nut
- M3 hardware packet

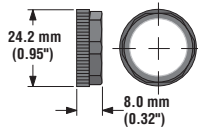

#### M3 Hardware Packet Contents:

- 2 – M3 x 0.5 x 20 mm SS Screw
- 2 – M3 x 0.5 SS Hex Nut
- 2 – M3 SS Washer

#### Model Suffix Q7

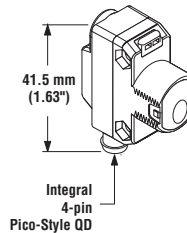

#### Model Suffix Q8

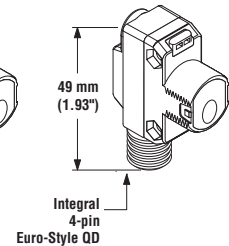

## Hookups

### NPN (Sinking) Outputs

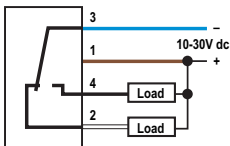

### PNP (Sourcing) Outputs

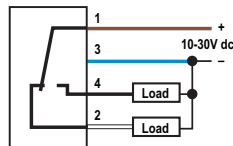

### 4-Pin Pico-Style Pin-out (Cable Connector Shown)

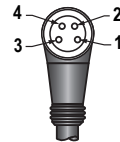

- 1 = Brown
- 2 = White
- 3 = Blue
- 4 = Black

### 4-Pin Euro-Style Pin-out (Cable Connector Shown)

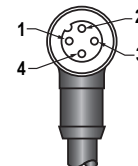

- 1 = Brown
- 2 = White
- 3 = Blue
- 4 = Black

## Euro-Style Quick-Disconnect Cordsets







Style	Model	Length	Dimensions
4-Pin Straight	MQDC-406	2 m (6.5')	
	MQDC-415	5 m (15')	
	MQDC-430	9 m (30')	
4-Pin Right-angle	MQDC-406RA	2 m (6.5')	
	MQDC-415RA	5 m (15')	
	MQDC-430RA	9 m (30')	

## Pico-Style Quick-Disconnect Cordsets

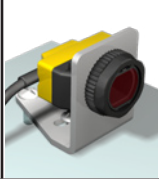
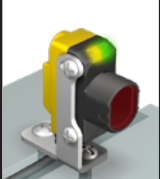
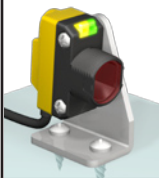
Style	Model	Length	Dimensions
4-Pin Straight	PKG4-2	2 m (6.5')	
4-Pin Right-angle	PKW4Z-2	2 m (6.5')	

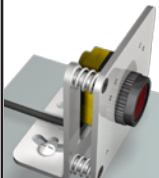
# WORLD BEAM® QS18LD Series

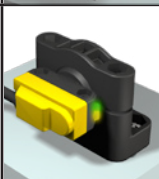
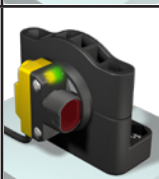
## Mounting Brackets

<b>SMB18A</b>	<ul style="list-style-type: none"> <li>• 12-gauge, stainless steel</li> <li>• Right-angle barrel-mount bracket</li> </ul>		<b>SMBQS18RA</b>	<ul style="list-style-type: none"> <li>• 14-gauge, 304 stainless steel</li> <li>• Right-angle side-mount bracket</li> </ul>	
<b>SMB312S</b>	<ul style="list-style-type: none"> <li>• Stainless steel</li> <li>• 2-axis, side-mounting bracket</li> </ul>		<b>SMB18FA</b>	<ul style="list-style-type: none"> <li>• 14-gauge, 304 stainless steel</li> <li>• 18 mm swivel bracket with tilt and pan movement for precision adjustment</li> </ul>	
<b>SMB46A</b>	<ul style="list-style-type: none"> <li>• 2-piece, 12-gauge, stainless steel bracket assembly with precision sensor alignment adjustment</li> <li>• Includes 2 mm hex key</li> </ul>		<b>SMBQS18Y</b>	<ul style="list-style-type: none"> <li>• Die-cast bracket for mounting into 18 mm holes</li> <li>• Metal hex nut and lock washer included</li> <li>• Cabled sensors tilt <math>\pm 8^\circ</math></li> </ul>	
<b>SMB18SF</b>	<ul style="list-style-type: none"> <li>• 18 mm swivel bracket</li> <li>• Black thermoplastic polyester</li> <li>• Includes stainless steel swivel locking hardware</li> </ul>				
<b>SMB3018SC</b>	<ul style="list-style-type: none"> <li>• 18 mm swivel side-mount bracket</li> <li>• Black reinforced thermoplastic polyester</li> <li>• Includes stainless steel swivel locking hardware</li> </ul>		<b>SMBQS18A</b>	<ul style="list-style-type: none"> <li>• Nickel-plated die-cast zinc</li> <li>• Wrap-around bracket</li> </ul>	

For bracket dimensions, visit [www.bannerengineering.com](http://www.bannerengineering.com).



**WARRANTY:** Banner Engineering Corp. warrants its products to be free from defects for one year. Banner Engineering Corp. will repair or replace, free of charge, any product of its manufacture found to be defective at the time it is returned to the factory during the warranty period. This warranty does not cover damage or liability for the improper application of Banner products. This warranty is in lieu of any other warranty either expressed or implied.

P/N 118899 rev. D

Banner Engineering Corp., 9714 Tenth Ave. No., Minneapolis, MN USA 55441 • Phone: 763.544.3164 • [www.bannerengineering.com](http://www.bannerengineering.com) • Email: [sensors@bannerengineering.com](mailto:sensors@bannerengineering.com)