

SM72238

SolarMagic 5V Micropower Voltage Regulator

General Description

The SM72238 is a micropower voltage regulator with very low quiescent current (75 μ A typ.) and very low dropout voltage (typ. 40mV at light loads and 380mV at 100mA). It is ideally suited for use in battery-powered systems. Furthermore, the quiescent current of the SM72238 increases only slightly in dropout, prolonging battery life.

The SM72238 is available in the surface-mount D-Pak package.

Careful design of the SM72238 has minimized all contributions to the error budget. This includes a tight initial tolerance (.5% typ.), extremely good load and line regulation (.05% typ.) and a very low output voltage temperature coefficient, making the part useful as a low-power voltage reference.

Features

- Renewable Energy Grade
- High accuracy output voltage
- Guaranteed 100mA output current
- Extremely low quiescent current
- Low dropout voltage
- Extremely tight load and line regulation
- Very low temperature coefficient
- Use as Regulator or Reference
- Needs minimum capacitance for stability
- Current and Thermal Limiting
- Stable with low-ESR output capacitors (10m Ω to 6 Ω)



Block Diagram and Typical Applications

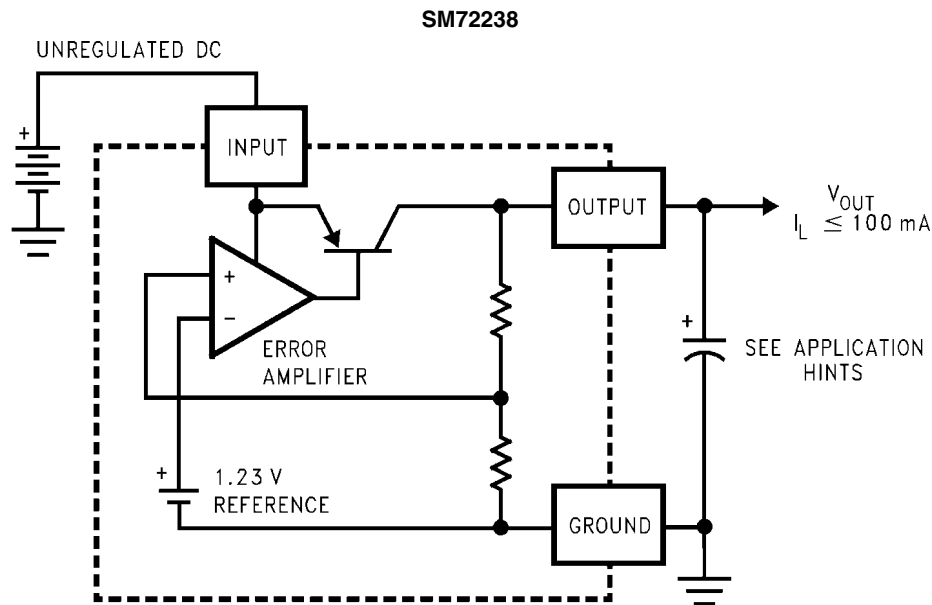

30141325

Connection Diagrams

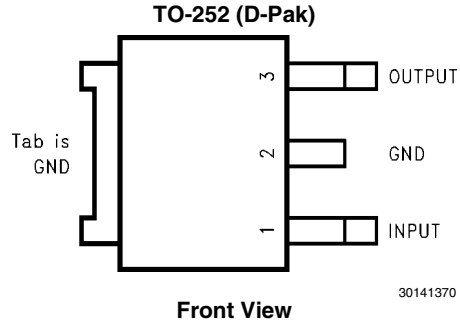

Ordering Information

Package	Temperature Range	V _{OUT}	Part Number	Package Marking	Transport Media	NSC Drawing
TO-252 (DPAK)	-40<T _J <125	5.0	SM72238X	S72238	2500 Units in Tape and Reel	TD03B
TO-252 (DPAK)	-40<T _J <125	5.0	SM72238E	S72238	250 Units in Tape and Reel	TD03B

Absolute Maximum Ratings (Note 1)

If Military/Aerospace specified devices are required, please contact the National Semiconductor Sales Office/Distributors for availability and specifications.

Input Supply Voltage	-0.3 to +30V
Power Dissipation	Internally Limited
Junction Temperature (T _J)	+150°C
Ambient Storage Temperature	-65° to +150°C
Soldering Dwell Time, Temperature	
Wave	4 seconds, 260°C
Infrared	10 seconds, 240°C
Vapor Phase	75 seconds, 219°C
ESD Rating	
Human Body Model (Note 11)	2500V

Operating Ratings (Note 1)

Maximum Input Supply Voltage	30V
Junction Temperature Range (T _J) (Note 6)	-40° to +125°C

Electrical Characteristics (Note 2)

Parameter	Conditions (Note 2)	Typ	Tested Limit (Note 3)	Design Limit (Note 4)	Units
Output Voltage	T _J = 25°C	5.0	5.05 4.95		V max V min
	-25°C ≤ T _J ≤ 85°C	5.0		5.075 4.925	V max V min
	Full Operating Temperature Range	5.0		5.1 4.9	V max V min
Output Voltage	100μA ≤ I _L ≤ 100mA T _J ≤ T _{JMAX}	5.0		5.12 4.88	V max V min
Output Voltage Temperature Coefficient	(Note 7)	50		150	ppm/°C
Line Regulation (Note 9)	(V _O NOM + 1)V ≤ V _{in} ≤ 30V (Note 10)	0.04	0.2	0.4	% max % max
Load Regulation (Note 9)	100μA ≤ I _L ≤ 100mA	0.1	0.2	0.3	% max % max
Dropout Voltage (Note 5)	I _L = 100μA	50	80	150	mV max mV max
	I _L = 100mA	380	450	600	mV max mV max
Ground Current	I _L = 100μA	75	120	140	μA max μA max
	I _L = 100mA	8	12	14	mA max mA max
Dropout Ground Current	V _{in} = (V _O NOM - 0.5)V I _L = 100μA	110	170	200	μA max μA max
Current Limit	V _{out} = 0	160	200	220	mA max mA max
Thermal Regulation	(Note 8)	0.05	0.2		%/W max
Output Noise, 10 Hz to 100 kHz	C _L = 1μF (5V Only)	430			μV rms
	C _L = 200μF	160			μV rms
	C _L = 3.3μF (Bypass = 0.01μF)	100			μV rms

Note 1: Absolute Maximum Ratings are limits beyond which damage to the device may occur. Operating Ratings are conditions under which operation of the device is guaranteed. Operating Ratings do not imply guaranteed performance limits. For guaranteed performance limits and associated test conditions, see the Electrical Characteristics tables.

Note 2: Unless otherwise specified all limits guaranteed for $V_{IN} = (V_{ONOM} + 1)V$, $I_L = 100\mu A$ and $C_L = 1\mu F$. Limits appearing in **boldface** type apply over the entire junction temperature range for operation. Limits appearing in normal type apply for $T_A = T_J = 25^\circ C$.

Note 3: Guaranteed and 100% production tested.

Note 4: Guaranteed but not 100% production tested. These limits are not used to calculate outgoing AQL levels.

Note 5: Dropout Voltage is defined as the input to output differential at which the output voltage drops 100 mV below its nominal value measured at 1V differential. At very low values of programmed output voltage, the minimum input supply voltage of 2V (2.3V over temperature) must be taken into account.

Note 6: Junction-to-case thermal resistance for the TO-252 package is $5.4^\circ C/W$.

Note 7: Output or reference voltage temperature coefficient is defined as the worst case voltage change divided by the total temperature range.

Note 8: Thermal regulation is defined as the change in output voltage at a time T after a change in power dissipation is applied, excluding load or line regulation effects. Specifications are for a 50mA load pulse at $V_{IN} = 30V$ (1.25W pulse) for $T = 10ms$.

Note 9: Regulation is measured at constant junction temperature, using pulse testing with a low duty cycle. Changes in output voltage due to heating effects are covered under the specification for thermal regulation.

Note 10: For $I_L = 100\mu A$ and $T_J = 125^\circ C$, line regulation is guaranteed by design to 0.2%. See Typical Performance Characteristics for line regulation versus temperature and load current.

Note 11: Human Body Model $1.5k\Omega$ in series with $100pF$.

Typical Performance Characteristics

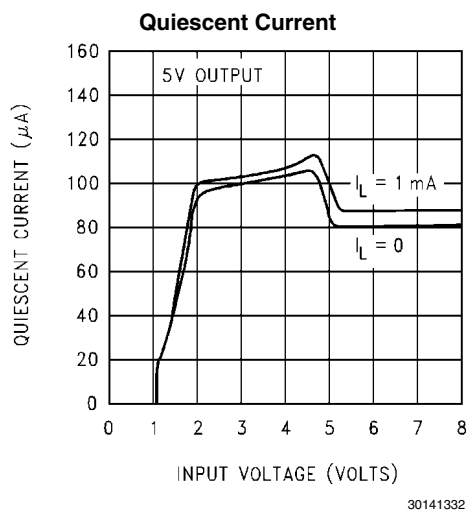
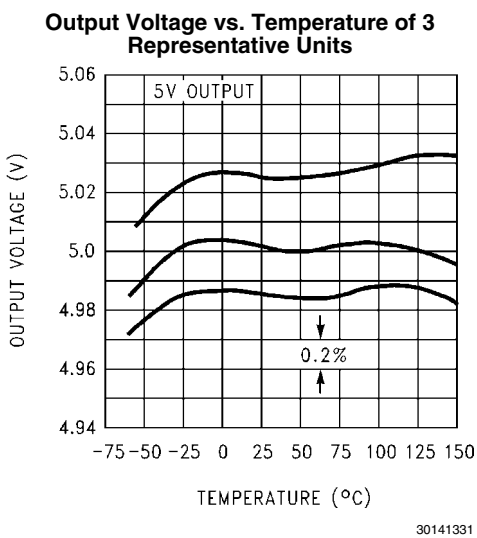
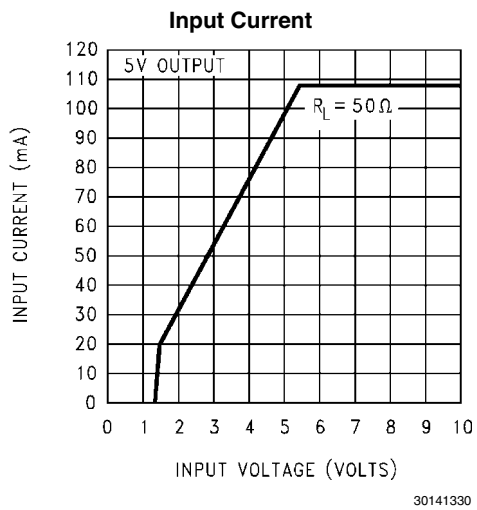
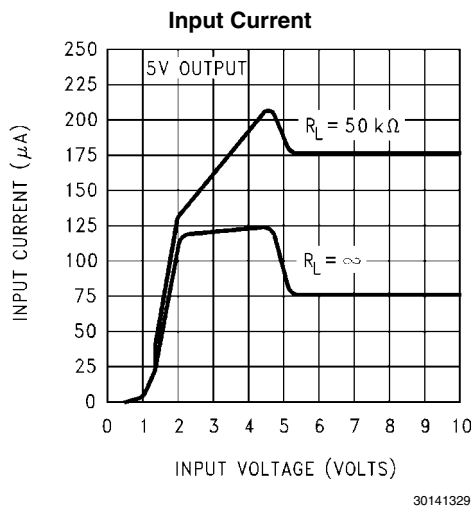
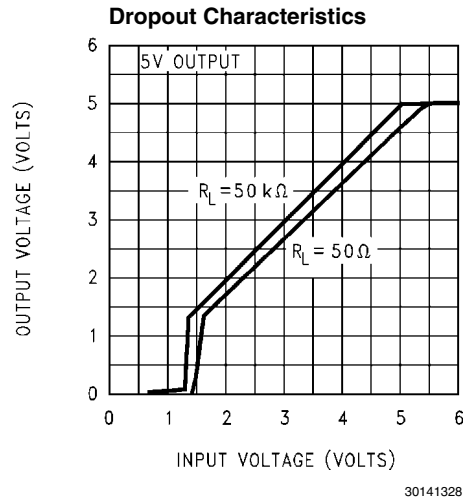
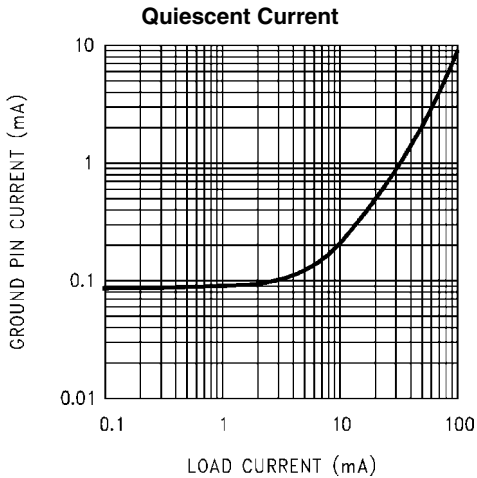

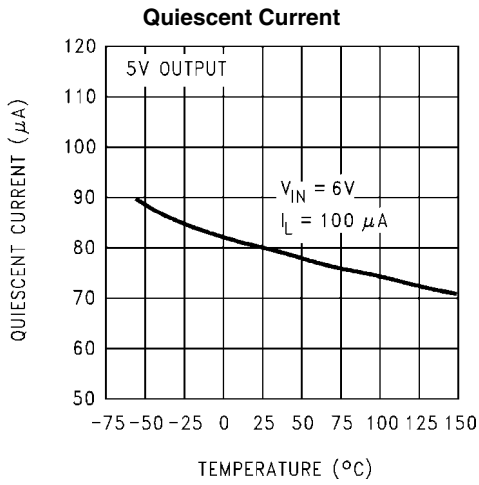

30141333

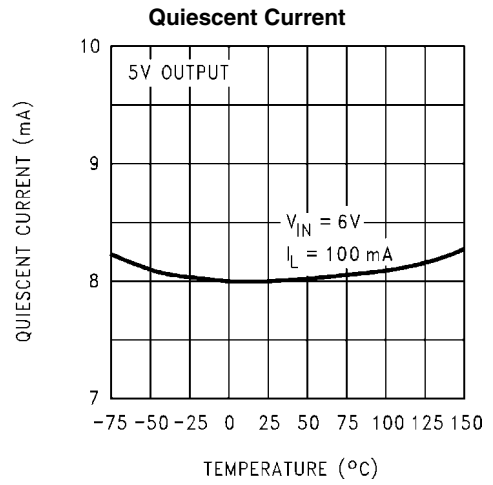

30141334

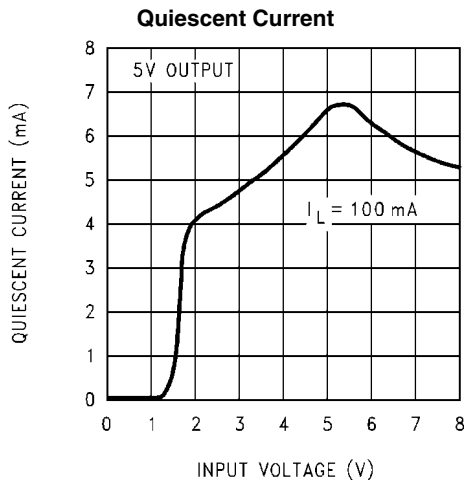

30141335

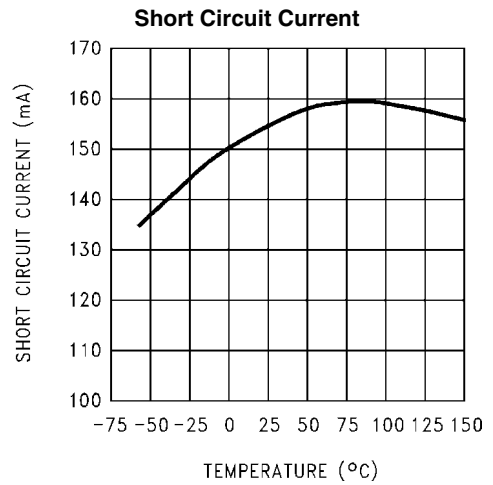

30141336

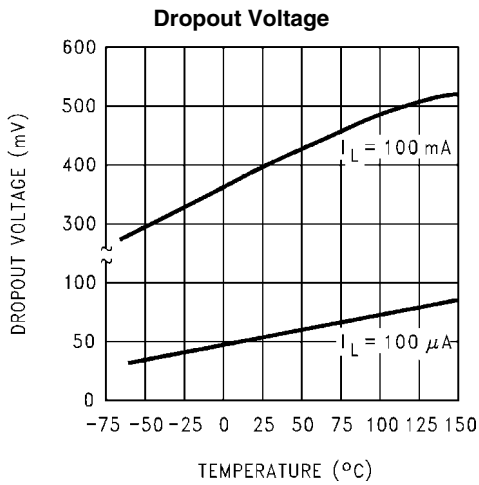

30141337

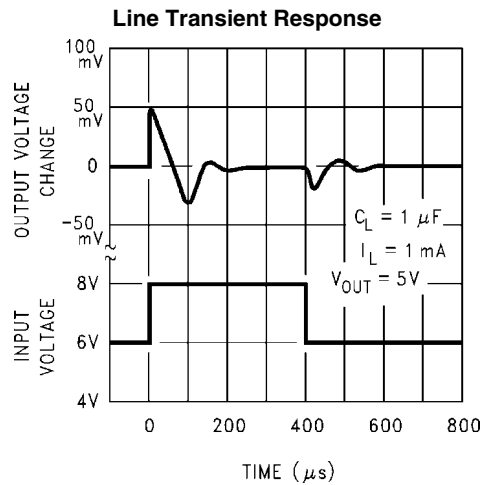

30141344

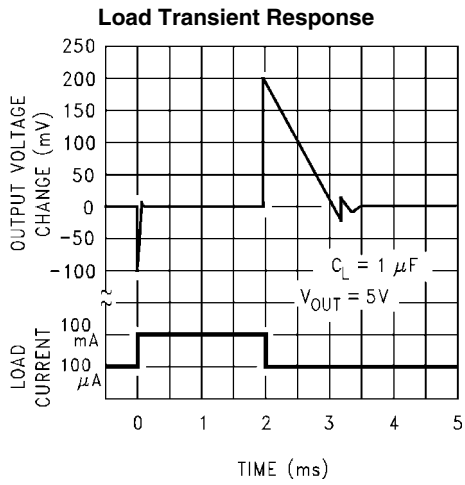

30141345

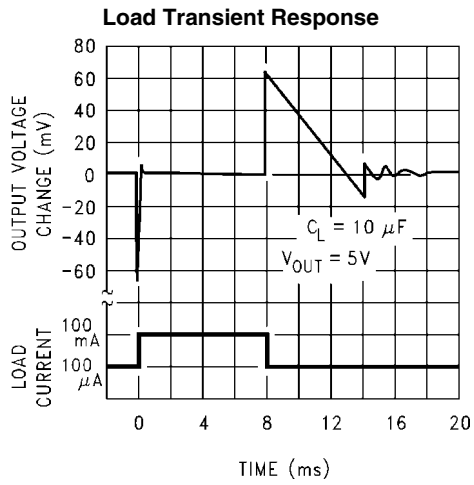

30141346

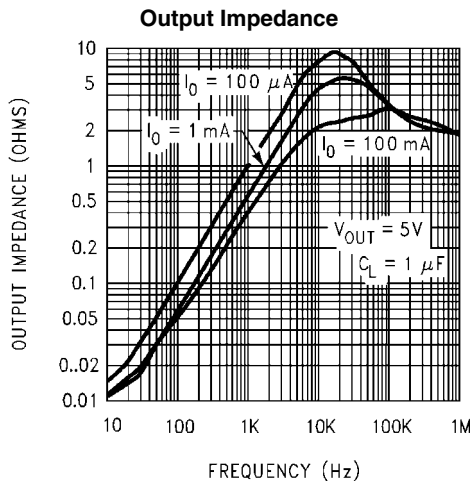

30141348

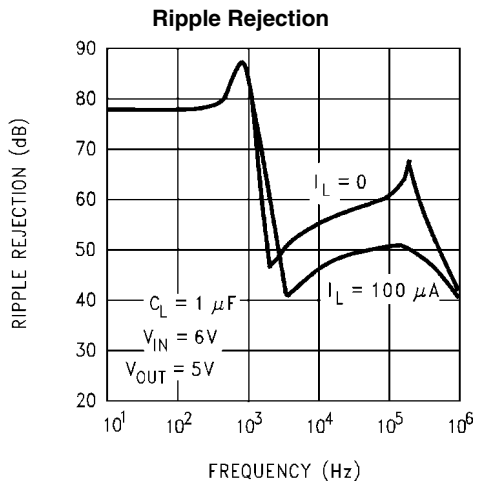

30141349

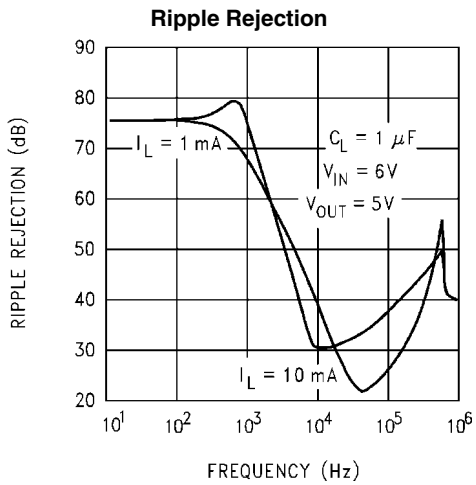

30141350

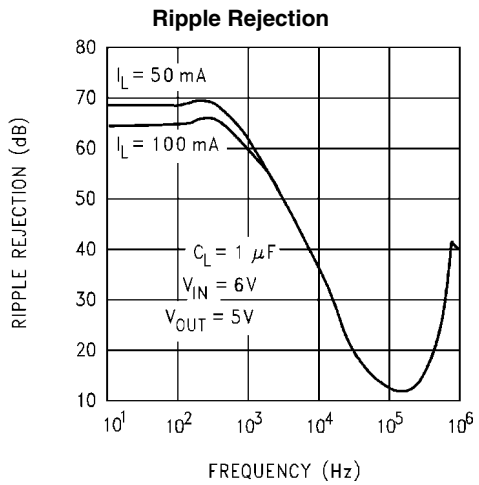

30141351

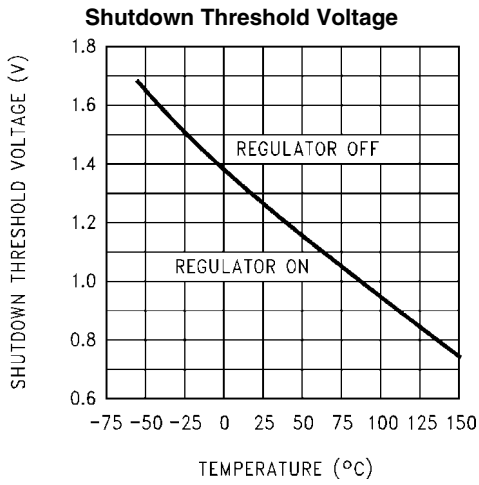

30141354

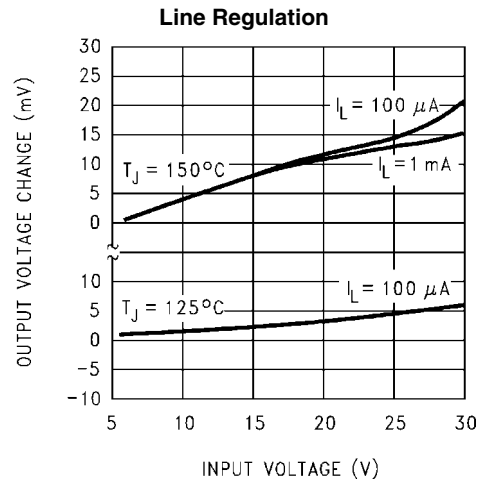

30141355

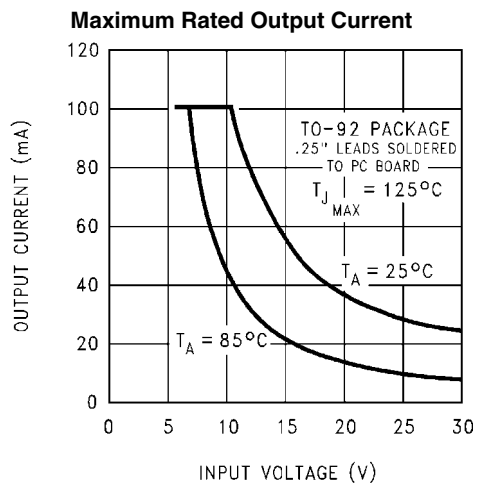

30141357

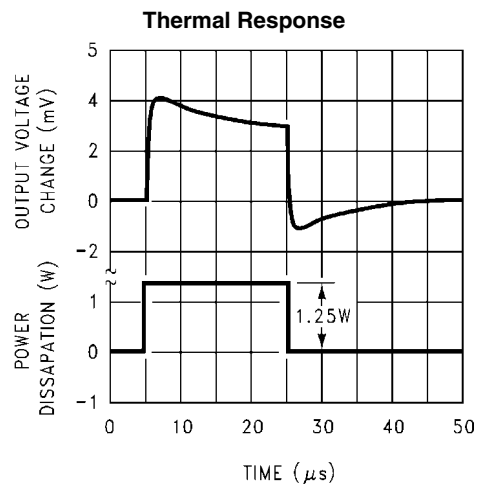

30141358

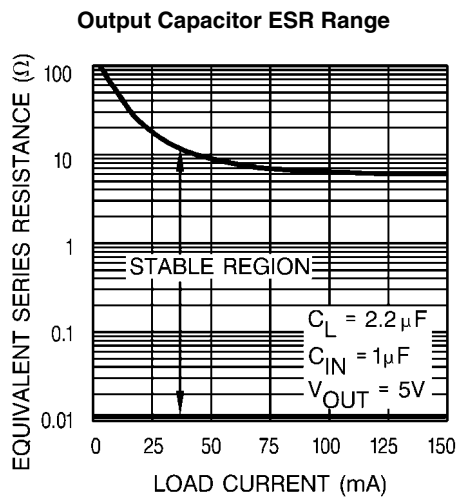

30141363

Application Hints

EXTERNAL CAPACITORS

A 1.0 μ F (or greater) capacitor is required between the output and ground for stability. Without this capacitor the part will oscillate. Most types of tantalum or aluminum electrolytics work fine here; even film types work but are not recommended for reasons of cost. Many aluminum electrolytics have electrolytes that freeze at about -30°C , so solid tantalums are recommended for operation below -25°C . The important parameters of the capacitor are an ESR of about 5 Ω or less and a resonant frequency above 500kHz. The value of this capacitor may be increased without limit.

Ceramic capacitors whose value is greater than 1000pF should not be connected directly from the SM72238 output to ground. Ceramic capacitors typically have ESR values in the range of 5 to 10m Ω , a value below the lower limit for stable operation (see curve Output Capacitor ESR Range).

The reason for the lower ESR limit is that the loop compensation of the part relies on the ESR of the output capacitor to provide the zero that gives added phase lead. The ESR of ceramic capacitors is so low that this phase lead does not occur, significantly reducing phase margin. A ceramic output

capacitor can be used if a series resistance is added (recommended value of resistance about 0.1 Ω to 2 Ω).

At lower values of output current, less output capacitance is required for stability. The capacitor can be reduced to 0.33 μ F for currents below 10mA or 0.1 μ F for currents below 1mA.

Unlike many other regulators, the SM72238 will remain stable and in regulation with no load in addition to the internal voltage divider. This is especially important in CMOS RAM keep-alive applications.

A 1 μ F tantalum, ceramic or aluminum electrolytic capacitor should be placed from the SM72238 input to ground if there is more than 10 inches of wire between the input and the AC filter capacitor or if a battery is used as the input.

REDUCING OUTPUT NOISE

In reference applications it may be advantageous to reduce the AC noise present at the output. One method is to reduce the regulator bandwidth by increasing the size of the output capacitor. This is the only way noise can be reduced but is relatively inefficient, as increasing the capacitor from 1 μ F to 220 μ F only decreases the noise from 430 μ V to 160 μ V rms for a 100kHz bandwidth at 5V output.

Typical Applications

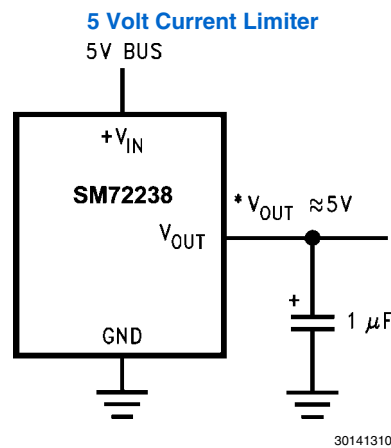

*Minimum input-output voltage ranges from 40mV to 400mV, depending on load current. Current limit is typically 160mA.

Schematic Diagram

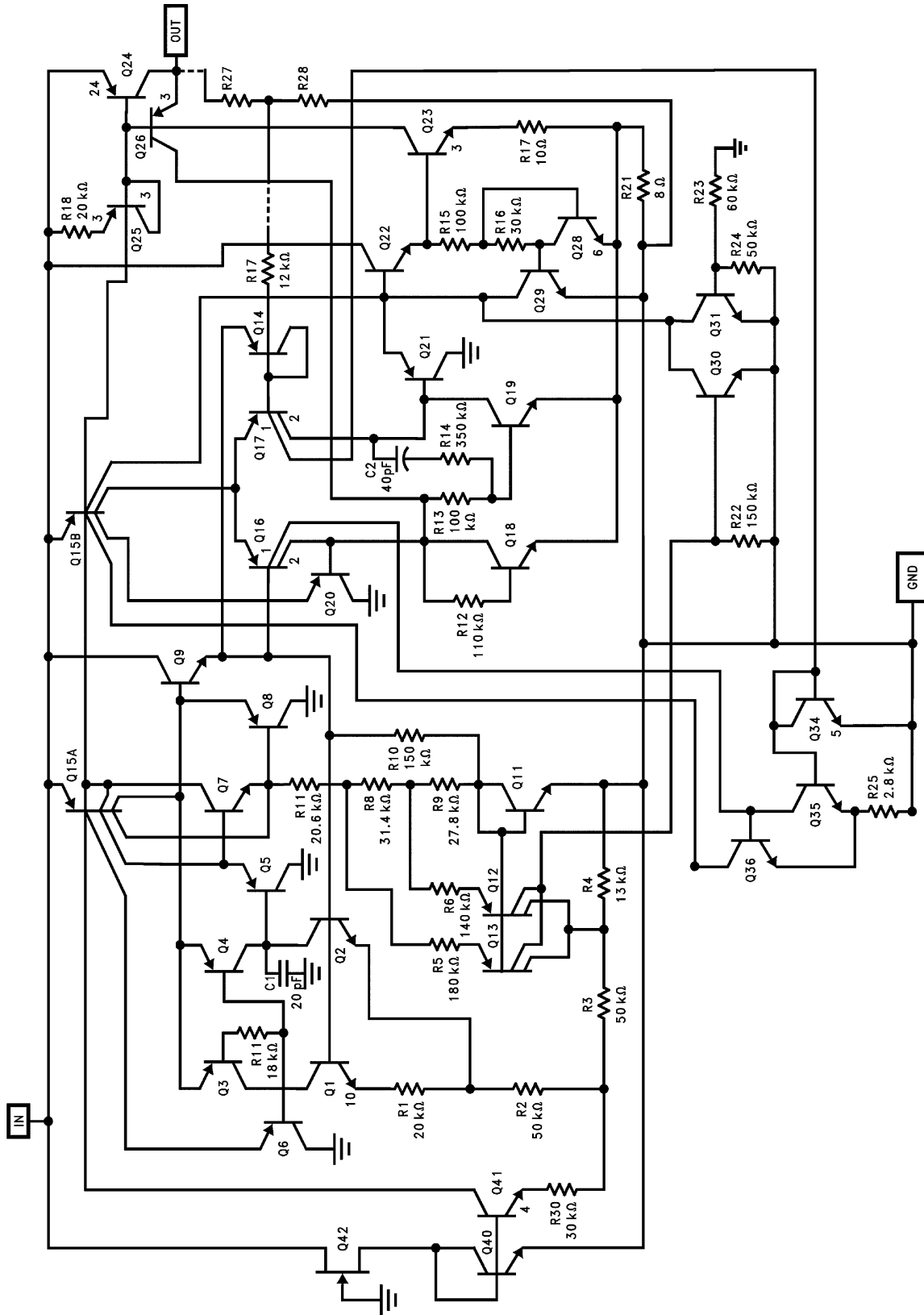

30141323

Physical Dimensions inches (millimeters) unless otherwise noted

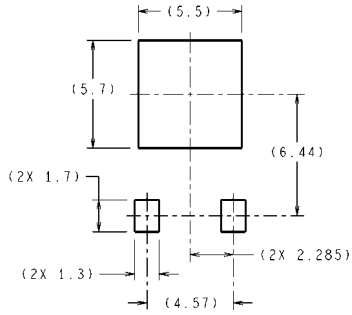

LAND PATTERN RECOMMENDATION

DIMENSIONS ARE IN MILLIMETERS

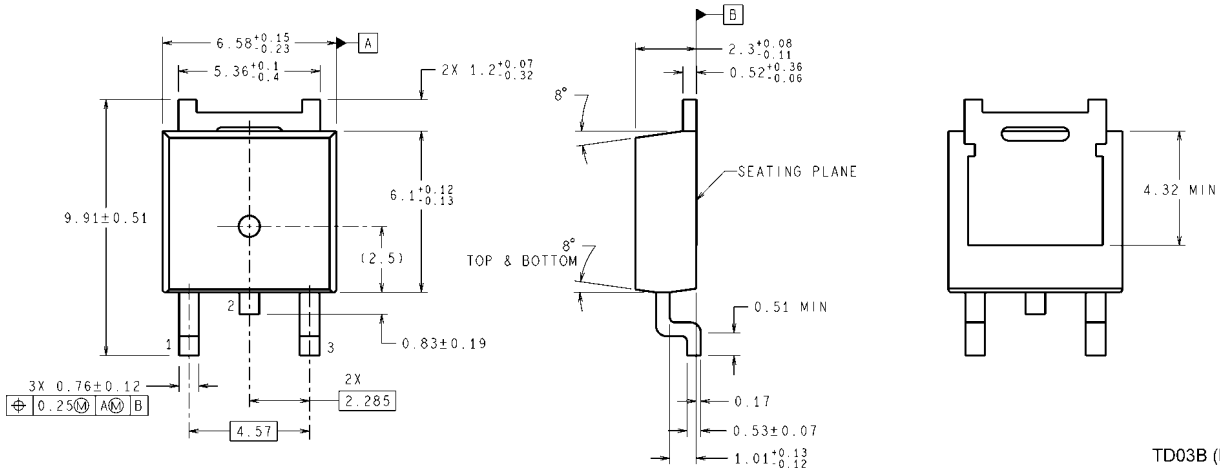

D-Pak Package
NS Package Number TD03B

TD03B (Rev E)

Notes

For more National Semiconductor product information and proven design tools, visit the following Web sites at:
www.national.com

Products		Design Support	
Amplifiers	www.national.com/amplifiers	WEBENCH® Tools	www.national.com/webench
Audio	www.national.com/audio	App Notes	www.national.com/appnotes
Clock and Timing	www.national.com/timing	Reference Designs	www.national.com/refdesigns
Data Converters	www.national.com/adc	Samples	www.national.com/samples
Interface	www.national.com/interface	Eval Boards	www.national.com/evalboards
LVDS	www.national.com/lvds	Packaging	www.national.com/packaging
Power Management	www.national.com/power	Green Compliance	www.national.com/quality/green
Switching Regulators	www.national.com/switchers	Distributors	www.national.com/contacts
LDOs	www.national.com/lido	Quality and Reliability	www.national.com/quality
LED Lighting	www.national.com/led	Feedback/Support	www.national.com/feedback
Voltage References	www.national.com/vref	Design Made Easy	www.national.com/easy
PowerWise® Solutions	www.national.com/powerwise	Applications & Markets	www.national.com/solutions
Serial Digital Interface (SDI)	www.national.com/sdi	Mil/Aero	www.national.com/milaero
Temperature Sensors	www.national.com/tempensors	SolarMagic™	www.national.com/solarmagic
PLL/VCO	www.national.com/wireless	PowerWise® Design University	www.national.com/training

THE CONTENTS OF THIS DOCUMENT ARE PROVIDED IN CONNECTION WITH NATIONAL SEMICONDUCTOR CORPORATION ("NATIONAL") PRODUCTS. NATIONAL MAKES NO REPRESENTATIONS OR WARRANTIES WITH RESPECT TO THE ACCURACY OR COMPLETENESS OF THE CONTENTS OF THIS PUBLICATION AND RESERVES THE RIGHT TO MAKE CHANGES TO SPECIFICATIONS AND PRODUCT DESCRIPTIONS AT ANY TIME WITHOUT NOTICE. NO LICENSE, WHETHER EXPRESS, IMPLIED, ARISING BY ESTOPPEL OR OTHERWISE, TO ANY INTELLECTUAL PROPERTY RIGHTS IS GRANTED BY THIS DOCUMENT.

TESTING AND OTHER QUALITY CONTROLS ARE USED TO THE EXTENT NATIONAL DEEMS NECESSARY TO SUPPORT NATIONAL'S PRODUCT WARRANTY. EXCEPT WHERE MANDATED BY GOVERNMENT REQUIREMENTS, TESTING OF ALL PARAMETERS OF EACH PRODUCT IS NOT NECESSARILY PERFORMED. NATIONAL ASSUMES NO LIABILITY FOR APPLICATIONS ASSISTANCE OR BUYER PRODUCT DESIGN. BUYERS ARE RESPONSIBLE FOR THEIR PRODUCTS AND APPLICATIONS USING NATIONAL COMPONENTS. PRIOR TO USING OR DISTRIBUTING ANY PRODUCTS THAT INCLUDE NATIONAL COMPONENTS, BUYERS SHOULD PROVIDE ADEQUATE DESIGN, TESTING AND OPERATING SAFEGUARDS.

EXCEPT AS PROVIDED IN NATIONAL'S TERMS AND CONDITIONS OF SALE FOR SUCH PRODUCTS, NATIONAL ASSUMES NO LIABILITY WHATSOEVER, AND NATIONAL DISCLAIMS ANY EXPRESS OR IMPLIED WARRANTY RELATING TO THE SALE AND/OR USE OF NATIONAL PRODUCTS INCLUDING LIABILITY OR WARRANTIES RELATING TO FITNESS FOR A PARTICULAR PURPOSE, MERCHANTABILITY, OR INFRINGEMENT OF ANY PATENT, COPYRIGHT OR OTHER INTELLECTUAL PROPERTY RIGHT.

LIFE SUPPORT POLICY

NATIONAL'S PRODUCTS ARE NOT AUTHORIZED FOR USE AS CRITICAL COMPONENTS IN LIFE SUPPORT DEVICES OR SYSTEMS WITHOUT THE EXPRESS PRIOR WRITTEN APPROVAL OF THE CHIEF EXECUTIVE OFFICER AND GENERAL COUNSEL OF NATIONAL SEMICONDUCTOR CORPORATION. As used herein:

Life support devices or systems are devices which (a) are intended for surgical implant into the body, or (b) support or sustain life and whose failure to perform when properly used in accordance with instructions for use provided in the labeling can be reasonably expected to result in a significant injury to the user. A critical component is any component in a life support device or system whose failure to perform can be reasonably expected to cause the failure of the life support device or system or to affect its safety or effectiveness.

National Semiconductor and the National Semiconductor logo are registered trademarks of National Semiconductor Corporation. All other brand or product names may be trademarks or registered trademarks of their respective holders.

Copyright© 2010 National Semiconductor Corporation

For the most current product information visit us at www.national.com



**National Semiconductor
Americas Technical
Support Center**
Email: support@nsc.com
Tel: 1-800-272-9959

**National Semiconductor Europe
Technical Support Center**
Email: europe.support@nsc.com

**National Semiconductor Asia
Pacific Technical Support Center**
Email: ap.support@nsc.com

**National Semiconductor Japan
Technical Support Center**
Email: jpn.feedback@nsc.com