

SHORT TUBULAR SENSORS

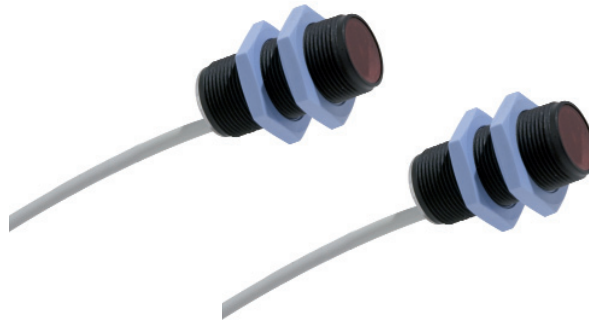

Above all others

- **Small housing of only 40 mm**
- **Cable output**
- **No sensitivity adjustment trimmer**
- **IP69K mechanical protection**

S15 SERIES

The main characteristic of the new M18 tubular **S15** sensors is the housing length of only 40 mm, especially suitable for applications with reduced space. The new **S15** series is available with cable output, in order to maximise the concept of 'reduced dimensions' as well as to offer contemporaneously the best installation flexibility. The **S15** series is supplied without the sensitivity adjustment trimmer to ease and speed-up installation. This feature drastically reduces the possibility of allowing the operator to modify the sensor's performances and so guaranteeing major reliability and productivity. The main optic functions used in the industrial market are available, polarised retroreflex, non-polarised retroreflex, diffuse proximity and through beam. These sensors are ideal for the most critical applications with harsh environmental conditions thanks to the IP69K mechanical protection.

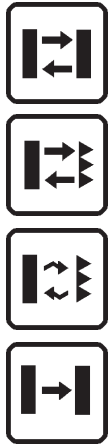

INSTALLATION

The sensor can be fixed by means of the M18x1 threaded body using CH.24 nuts (1.5 Nm maximum tightening torque) or low-profile flared nut provided specifically supplied for . Various orientable fixing brackets are available to ease sensor positioning (please refer to the accessories listed in the general catalogue).

The operating distance is measured from the front surface of the sensor lens.

C models: the object has to be moved closer or further away from the front surface of the sensor lens to improve detection.

In case of lateral translation, the object must move as indicated in the figure.



DIMENSIONS

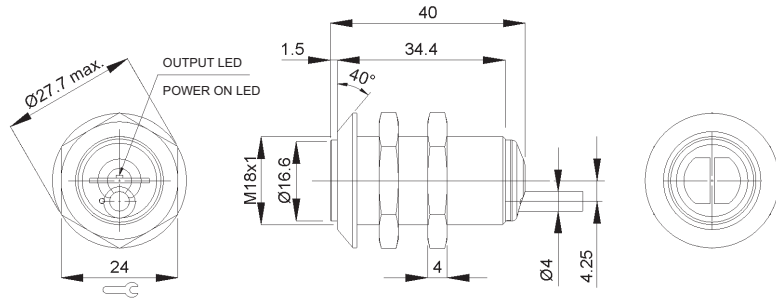

mm

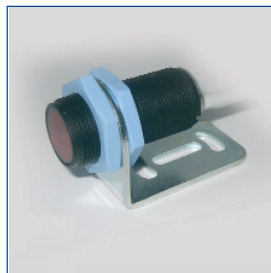

ACCESSORIES

For **dedicated accessories** refer to the **ACCESSORIES** section.

Refer also to **Connectors** and **Reflectors** of the **General Catalogue**.

CONNECTIONS

S15-...A00/B00/C00/C10/F00

BROWN	<u>1</u>	+	+ 12 ... 30 Vdc
WHITE	<u>2</u>		Dark / Light
BLACK	<u>4</u>		Output
BLUE	<u>3</u>	-	0V

S15-...G00

BROWN	<u>1</u>	+	+ 12 ... 30 Vdc
WHITE	<u>2</u>		Test +
BLACK	<u>4</u>		Test -
BLUE	<u>3</u>	-	0V

TECHNICAL DATA

		S15-PA-2-A00	S15-PA-2-B00	S15-PA-2-C00	S15-PA-2-C10	S15-PA-2-F00	S15-PA-2-G00
Long diffuse proximity operating distance:	1 ... 35 cm						
Short diffuse proximity operating distance:	1 ... 10 cm						
Retroreflex operating distance:	0,1...4 m on R2	•					
Polarised retroreflex operating distance:	0,1...3 m on R2		•				
Through beam operating distance:	0...20 m					•	•
Power supply:	12 ... 30 Vdc ¹	•	•	•	•	•	•
Ripple:	≤ 2 Vpp	•	•	•	•	•	•
Consumption:	≤ 30 mA	•	•	•	•	•	•
Light emission²:	infrared LED 880 nm	•	•	•	•	•	•
	red LED 660 nm		•				
Indicators:	yellow OUTPUT LED	•	•	•	•		
	green POWER LED						•
Output type:	PNP (-PP suffix)	•	•	•	•	•	•
	NPN (-NN suffix)	•	•	•	•	•	•
Output current:	≤ 100 mA	•	•	•	•	•	•
Saturation voltage:	≤ 2 V	•	•	•	•	•	•
Response time:	1 ms	•	•	•	•		
	4 ms					•	
Switching frequency:	≤ 500 Hz	•	•	•	•		
	≤ 120 Hz					•	
Operating mode:	selectable dark/light ³	•	•	•	•	•	•
Auxiliary functions:	Test + and Test -						•
Connections:	2 m Ø 4 mm cable ⁴	•	•	•	•	•	•
Electrical protection:	class 2	•	•	•	•	•	•
Mechanical protection:	IP69K	•	•	•	•	•	•
Protection devices:	A, B ⁵	•	•	•	•	•	•
Housing material:	PBT	•	•	•	•	•	•
Lens material:	plastic PMMA	•	•	•	•	•	•
Weight:	75 g max.	•	•	•	•	•	•
Operating temperature:	-25 ... +55°C	•	•	•	•	•	•
Storage temperature:	-25 ... +70°C	•	•	•	•	•	•
Reference standard:	EN 60947-5-2, UL 508	•	•	•	•	•	•

TECHNICAL NOTES

¹ Limit values

² Average life of 100.000 h with $T_A = +25\text{ °C}$

³ With L/D input not connected the proximity models function in the light mode and the retroreflex and through beam models in the dark mode; the light mode can be selected connecting the L/D input to +Vdc, the dark mode connecting it to 0Vdc

⁴ PVC, 4 x 0.14 mm²

⁵ A - reverse polarity protection

B - overload and short-circuit protection



DETECTION DIAGRAMS

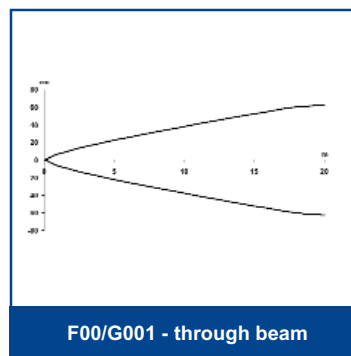
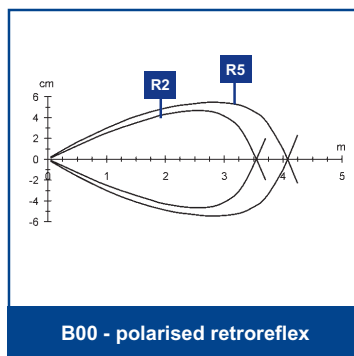
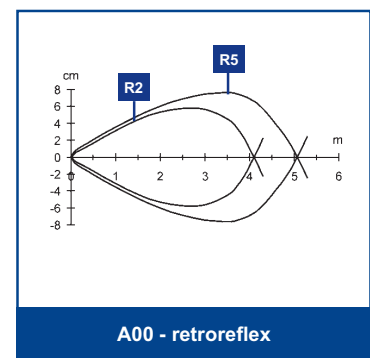
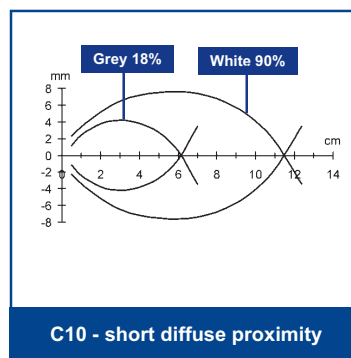
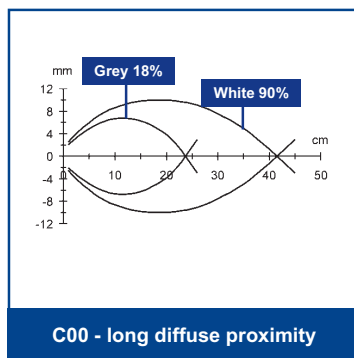

MODEL SELECTION AND ORDER INFORMATION

MODEL	OPTIC FUNCTION	OUTPUT	ORDER N°
S15-PA-2-A00-PK	retroreflex	PNP	952301000
S15-PA-2-B00-PK	polarised retroreflex	PNP	952301010
S15-PA-2-C10-PK	short diffuse proximity	PNP	952301020
S15-PA-2-C00-PK	long diffuse proximity	PNP	952301030
S15-PA-2-F00-PK	receiver	PNP	952301040
S15-PA-2-A00-NK	retroreflex	NPN	952301050
S15-PA-2-B00-NK	polarised retroreflex	NPN	952301060
S15-PA-2-C10-NK	short diffuse proximity	NPN	952301070
S15-PA-2-C00-NK	long diffuse proximity	NPN	952301080
S15-PA-2-F00-NK	receiver	NPN	952301090
S15-PA-2-G00-XG	emitter	-	952301100

ACCESSORIES

DIMENSIONS

ST-5013

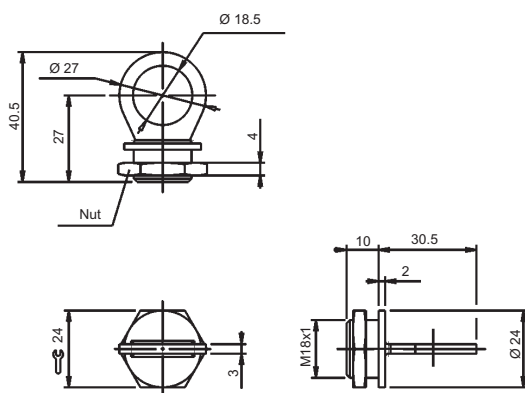

PLASTIC NUT

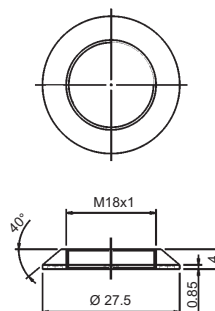

mm

ACCESSORY SELECTION AND ORDER INFORMATION

MODEL	DESCRIPTION	ORDER N°
PLASTIC NUTS	flared fixing nut	95ACC2630
ST-5011	M18 fixing bracket	95ACC5240
ST-5012	M18 fixing bracket	95ACC5250
ST-5013	round-18	95ACC5260
ST-5017	M18 fixing bracket	95ACC5270
MICRO-18	support with micrometric regulation for tubular M18 sensors	95ACC1380
SP-40	fixed support for tubular M18 sensors	95ACC1370

Refer also to **Accessories for Sensors** of the **General Catalogue**

Distributed by:



HEADQUARTERS

DATASENSOR SpA

via Lavino, 265 - 40050 Monte San Pietro, BO - Italy
 Tel. +39 051/6765611 • Fax +39 051/6759324
 www.datasensor.com • e-mail info@datasensor.com

Datasensor SpA endeavours to continuously improve and renew its products; for this reason the technical data and contents of this catalogue may undergo variations without prior notice. For correct installation and use Datasensor SpA can guarantee only the data indicated in the instruction manual supplied with the products.

Printed in Italy in March 2008
 Rev. 00

UNIVERSAL TUBULAR SENSORS