

simatic



Products for
Totally Integrated Automation
and Micro Automation

SIEMENS

Related catalogs

SIMATIC

SIMATIC S5/505
Automation systems

Available as PDF only:
http://www.siemens.com/automation/simatic/ftp/st50/html_76/st5098_e.pdf

ST 50

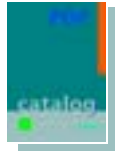

Industrial Communication
Industrial Communication
for Automation and Drives

Order No.:
E86060-K6710-A101-B4-7600

IK PI



SIMATIC HMI
Human Machine
Interface Systems

Order No.:
E86060-K4680-A101-B3-7600

ST 80



PC-based Automation

Order No.:
E86060-K4670-B111-B3-7600

ST PC



Sensor Technology
Factory Automation Sensors

Order No.:
E86060-K8310-A101-A1-7600

FS 10



SITRAIN Information and Training
SITRAIN on CD

Order No.:
E86060-D6850-A100-C2-7400



Catalog CA01 -
the offline Mall of
Automation and Drives

Order No.:
E86060-D4001-A100-C3-7600

CA 01



A&D Mall

Internet:
www.siemens.com/automation/mall



Trademarks

All product designations may be trademarks or product names of Siemens AG or supplier companies whose use by third parties for their own purposes could violate the rights of the owners.

According to the German law on units in measuring technology, data in inches only apply to devices for export.

Products for Totally Integrated Automation and Micro Automation

Catalog ST 70 · 2005

Supersedes:
Catalog ST 70 · 2003

The products contained in this
catalog are also contained in
the electronic catalog CA 01
Order No.:
E86060-D4001-A100-C3-7600

Please contact your nearest
Siemens branch office.

© Siemens AG 2004



The products and systems described in this catalog are manufactured/distributed under application of a certified quality management system in accordance with DIN EN ISO 9001 (Certified Registration No. 1323-QM).

The certificate is recognized by all IQNet countries.



SIEMENS

Introduction	1
LOGO! logic module	2
SIMATIC S7-200	3
SIMATIC S7-300	4
SIMATIC S7-400	5
SIMATIC C7	6
SIMATIC Industrial Software	7
SIMATIC Programming devices	8
SIMATIC PC-based Automation	9
Component Based Automation	10
Overviews SIMATIC DP, PROFINET, SIMATIC PCS 7, SIMATIC HMI, SIMATIC NET, SIMATIC PC, Factory Automation Sensors	11
Supplementary components	12
Appendix	13

Welcome to Automation and Drives

We would like to welcome you to Automation and Drives and our comprehensive range of products, systems, solutions and services for production and process automation and building technology worldwide.

With Totally Integrated Automation and Totally Integrated Power, we deliver solution platforms based on standards that offer you a considerable savings potential.

Discover the world of our technology now. If you need more detailed information, please contact one of your regional Siemens partners.

They will be glad to assist you.



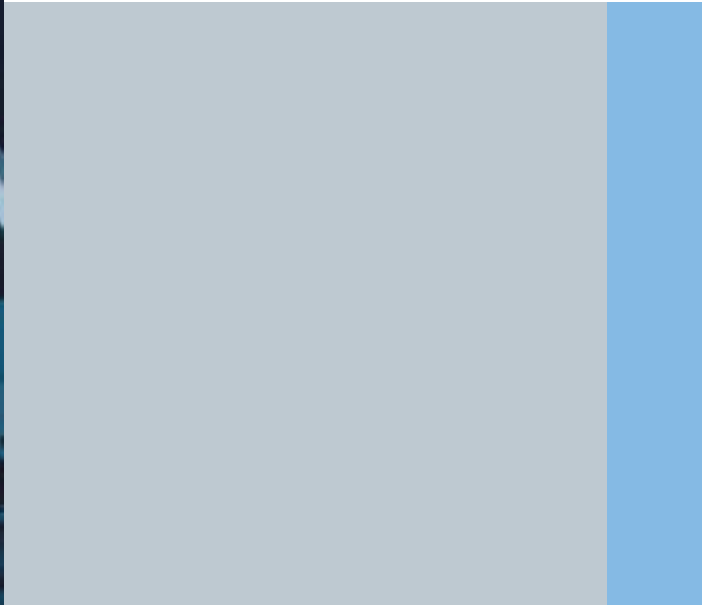

Totally Integrated Automation – innovations for more productivity

With the launch of Totally Integrated Automation, we were the first ones on the market to consistently implement the trend from equipment to an integrated automation solution, and have continuously improved the system ever since. Whether your industry is process- and production-oriented or a hybrid, Totally Integrated Automation is a unique "common solution" platform that covers all the sectors. Totally Integrated Automation is an integrated platform for the entire production line - from receiving to technical processing

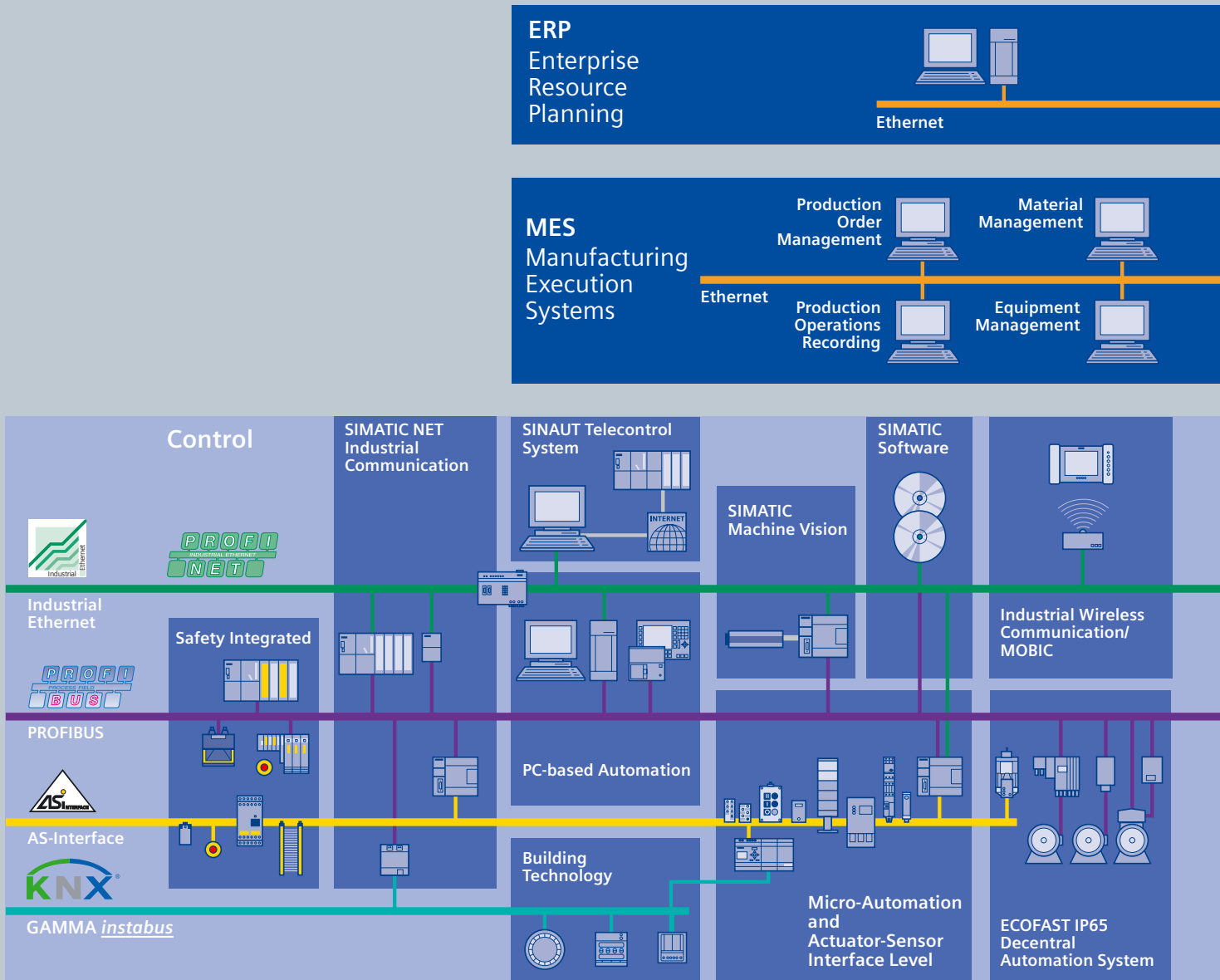

and production areas to shipping. Thanks to the system-oriented engineering environment, integrated, open communications as well as intelligent diagnostics options, your plant now benefits in every phase of the life cycle.

In fact, to this day we are the only company worldwide that can offer a control system based on an integrated platform for both the production and process industry.

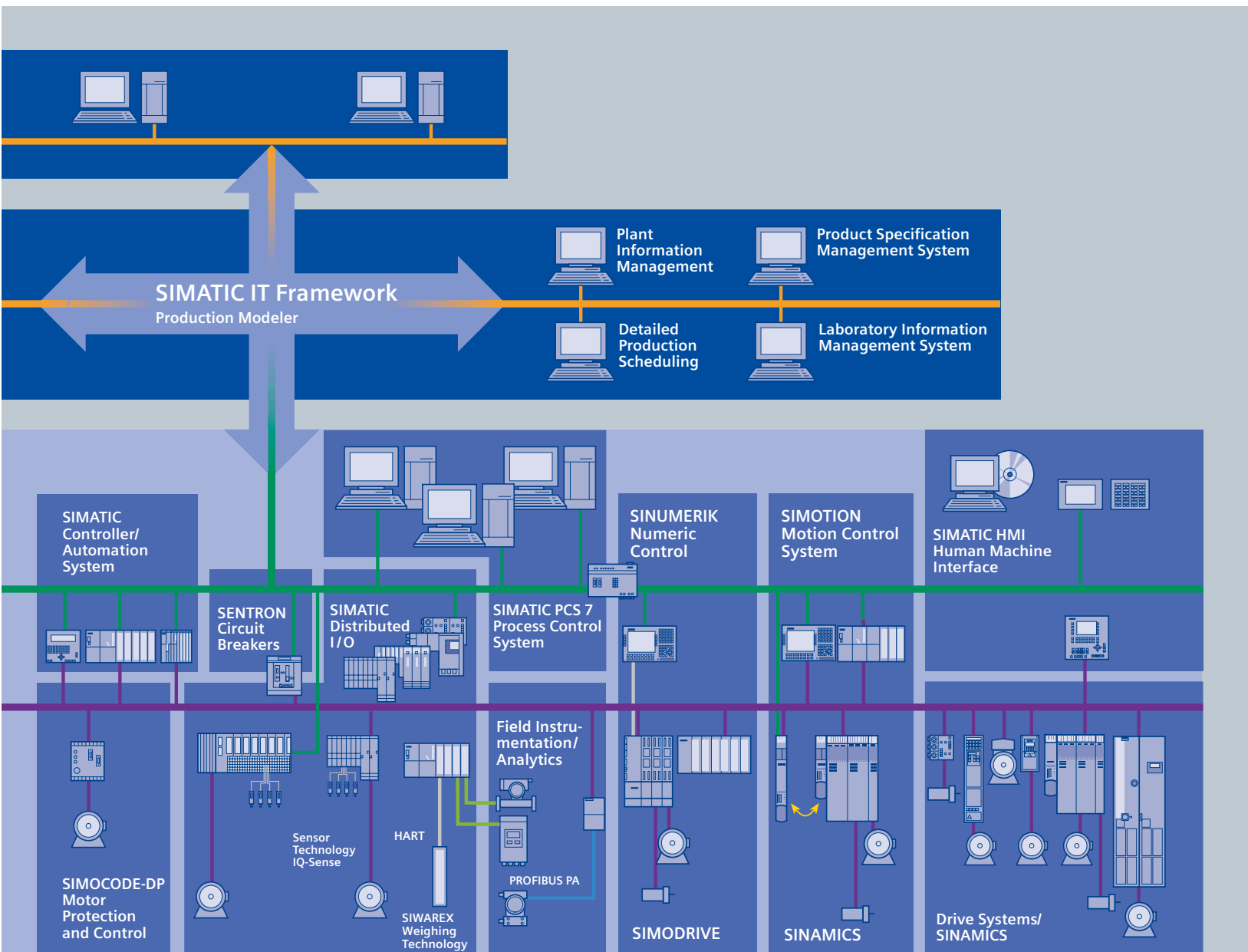

Totally Integrated Power – energy distribution and management from one source

Totally Integrated Power™ by Siemens offers integrated solutions for energy distribution in functional and industrial buildings covering everything from medium-high voltage to power outlets.

Totally Integrated Power™ is based on integration in planning and configuration as well as coordinated products and systems. In addition, it features communications and software modules for connecting power distribution systems to industrial automation and building automation, thereby offering a substantial savings potential.

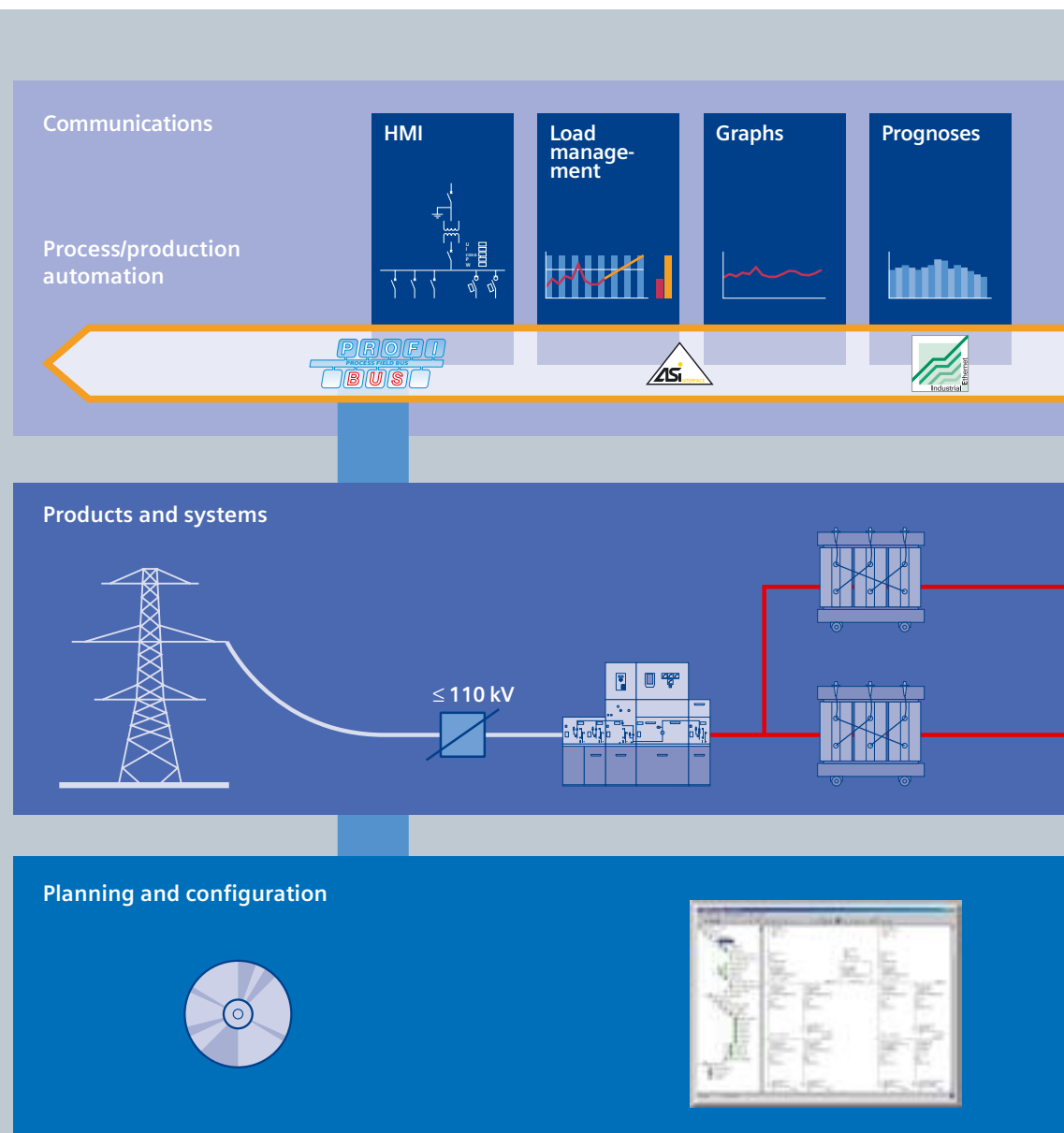

Maintenance

- Substation
- Distribution
- Maintenance task

Hall 1 Air conditioning system
Distribution 3 Replacing circuit
Infobid 2 Replacing meters

Message/ error management



Selective protection



Protocols

Protocol	Device	Status	Address
BACnet
KNX
EIB

Power quality

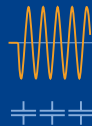

Cost center

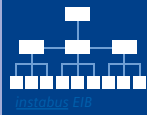

Building
automation

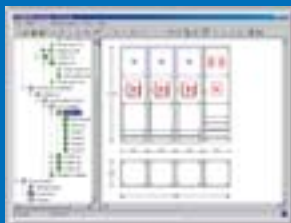
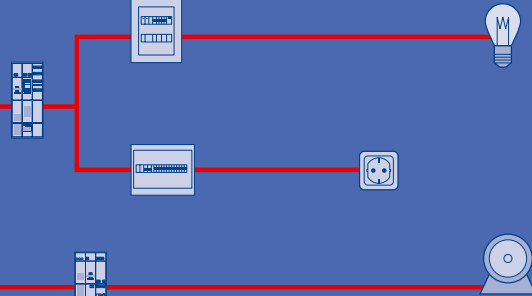

Introduction

Micro Automation

LOGO!:
Technology with a future
which simplifies many things

LOGO! Logic Module

The compact, user-friendly and low-cost solution for simple control tasks.

For universal applications in the industry, non-residential buildings or residential buildings.

No wiring is necessary since functions are linked.

Operates in a similar manner as a PLC.

With integrated operator control and display unit for input of alarm message texts / variables direct at the device.

Easy operation:

- Linking of functions at the click of the mouse at the PC or by pressing a key on the device

Minimum expenditure of time:

- Only the inputs and outputs need to be wired
- Simultaneous wiring diagram generation and control cabinet installation

Reduced costs:

- Many switchgear technology functions are integrated

High flexibility:

- Functions are simply modified at the push of a button
- Variants for different operating voltages
- Modular design, can be expanded at any time

Further information can be found at:

<http://www.siemens.com/logo>



LOGO!	24 24o	12/24RC 12/24RCo	24RC 24RCo	230RC 230RCo
Supply voltage	24 V DC	12/24 V DC	24 V AC/DC	115/230 V AC/DC
Inputs	8 (2 can be used as analog inputs)	8 (2 can be used as analog inputs)	8	8
Outputs	4, transistor	4, relay		
Continuous current	0.3 A	10 A (under resistive load); 3 A (under inductive load)		
Short-circuit protection	electrical (1 A)	external fuse protection required		
Integrated time switches/ power reserve	—	8/typ. 80 h		
Ambient temperature	0 to +55 °C			
RI suppression	to EN 50 011 (limit class B)			
Degree of protection	IP20			
Certification	to VDE 0631, IEC 1131, UL, FM, CSA, marine approvals			
Mounting	on 35 mm DIN rail or wall mounting			
Dimensions (B x H x T)	72 x 90 x 55 mm (4 width modules)			

■ = can be used/available
 --- = can not be used/not available

**SIMATIC S7-200:
Control technology that
is a class of its own**

SIMATIC S7-200

The Micro PLC SIMATIC S7-200 is truly in a class of its own: it is both compact and highly powerful (e.g. in relation to its real-time response), it is fast, features great communications capabilities and comes with very user-friendly software and hardware.

- Graduated range of CPUs with many basic PLC functions.
- Modular expansion capability for individual adaptations to the respective tasks.
- Can be easily networked over point-to-point interfaces (PPI) with the functions programming, communication, operator control and monitoring.
- Programming with STEP 7-Micro/WIN - a software especially optimized for the performance range of the S7-200.
- Wizards for particularly easy and user-friendly operation.

Further information can be found at:

<http://www.siemens.com/s7-200>

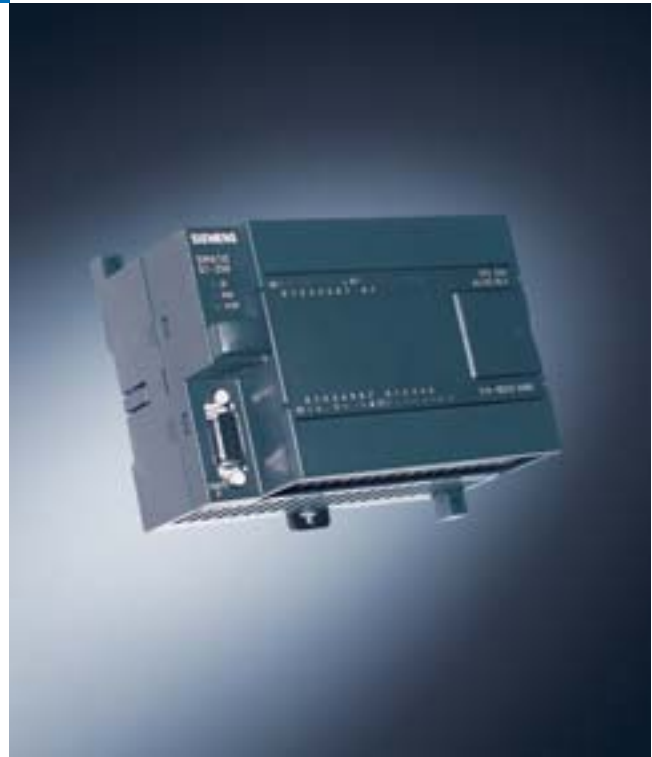

SIMATIC S7-200	CPU 221	CPU 222	CPU 224	CPU 224 XP	CPU 226
Program memory	4 KB	4 KB	8/12 KB	12/16 KB	16 /24 KB
Data memory	2 KB	2 KB	8 KB	10 KB	10 KB
Processing time per binary instruction	0.22 µs	0.22 µs	0.22 µs	0.22 µs	0.22 µs
Bit memories	256	256	256	256	256
Counters	256	256	256	256	256
Timers	256	256	256	256	256
Digital inputs/outputs	max. 10; 10 integrated	max. 40 / 38; 14 integrated	max. 94 / 74; 24 integrated	max. 94 / 74; 24 integrated	max. 128 / 120; 40 integrated
Analog inputs/outputs	---	max. 8/2 or 0/4	max. 28/7 or 0/14	max. 28/7 or 0/14 3 integrated	max. 28/7 or 0/14
HMI devices	■	■	■	■	■
Communication interface	1 x PPI (point-to-point)	1 x PPI (point-to-point)	1 x PPI (point-to-point)	2 x PPI (point-to-point)	2 x PPI (point-to-point)
Networking	---	AS-Interface PROFIBUS DP Ethernet Internet Modem	AS-Interface PROFIBUS DP Ethernet Internet Modem	AS-Interface PROFIBUS DP Ethernet Internet Modem	AS-Interface PROFIBUS DP Ethernet Internet Modem
Real-time clock	optional	optional	integrated	integrated	integrated

■ = can be used/available
 --- = can not be used/not available

Introduction SIMATIC Controller

SIMATIC S7-300:
For system solutions with focus
on the manufacturing industry

SIMATIC S7-300

PLC with modular expansion capability, mainly for applications in the manufacturing industry.

Complete integration in Totally Integrated Automation:

- Efficient configuring and programming with STEP 7 - also with the engineering tools.
- Networking via MPI and SIMATIC NET - now also with PROFINET.

The graduated CPU range, from entry-level CPUs right up to high-performance CPUs, permits short machine cycle times thanks to efficient processing speeds.

The following CPUs are available:

- Standard CPUs, also with integrated PROFINET interface.
- Failsafe CPUs for implementing failsafe applications with the PROFIsafe profile and failsafe signal modules.
- Compact CPUs with integrated I/O, integrated technological functions and integrated communications interfaces for special tasks.
- Technology CPUs with integrated technology and motion control functionality.



SIMATIC S7-300	CPU 312	CPU 314/ 315-2 DP	CPU 317-2 DP/ 317-2 PN/DP	CPU 318-2 DP	CPU 315F-2 DP	CPU 317F-2 DP
User memory	16 KB	48/128 KB	512 KB	512 KB	192 KB ¹⁾	512 KB ²⁾
Load memory over MMC	64 KB to 4 MB	64 KB to 8 MB	64 KB to 8 MB	---	64 KB to 4 MB	64 KB to 4 MB
Processing times (µs)						
Bit/word/fixed pt./floating pt.	0.2/2/4/6	0.1/1/2/3	0.05/0.2/0.2/1	0.1/0.1/0.1/0.6	0.1/1/2/3	0.05/0.2/0.2/1
Timers/counters	128/128	256/256	512/512	512/512	256/256	512/512
Address ranges						
Digital channels	256	1024	1024	1024	1024	1024
Analog channels	64	256	256	256	256	256
Interfaces						
MPI	■	■	■	■	■	■
PROFIBUS DP	---	■ (315-2 DP)	■	■	■	■
PtP communication	---	---	---	---	---	---
Integrated inputs/outputs						
DI/DO	---	---	---	---	---	---
AI/AO	---	---	---	---	---	---
Integrated functions						
Counter/frequency meter	---	---	---	---	---	---
Pulse outputs	---	---	---	---	---	---
Controlling/positioning	---/--	---/--	---/--	---/--	---/--	---/--
Mounting dim. WxHxD (mm)	40 x 125 x 130	40 x 125 x 130	80 x 125 x 130	160 x 125 x 130	40 x 125 x 130	80 x 125 x 130

■ = can be used/available
--- = can not be used/not available

1) Depends on the programming, e.g. 36 KB F-instructions possible.

2) Depends on the programming, e.g. 100 KB F-instructions possible.

SIMATIC S7-300:
For system solutions with focus
on the manufacturing industry

The Micro Memory Card (MMC) as data and program memory renders buffer batteries superfluous. An entire project incl. symbols can be stored on the MMC, enabling simple program updates. Thanks to write and read access in RUN, measured values can be archived and recipes can be processed as well. Modular expansion capability and up to 3 expansion units. Modular system with hardware and software components for implementing technological functions. Thanks to its compact design it is perfectly suited to limited space conditions and distributed configurations. Easy installation with DIN rail and modules with integrated backplane bus, no need to adhere to slot rules. Maintenance-free operation without fans. Powerful diagnostics functionality to achieve a higher availability of the control. Further information can be found at: <http://www.siemens.com/simatic-s7-300>



SIMATIC S7-300	CPU 312C	CPU 313C	CPU 313C-2 PtP/ 313-2 DP	CPU 314C-2 DP/ 314-2 DP	CPU 317T-2 DP
User memory Load memory over MMC	16 KB 64 KB to 4 MB	32 KB 64 KB to 4 MB	32 KB 64 KB to 4 MB	48 KB 64 KB to 4 MB	512 KB 4 MB to 8 MB
Processing times (µs) Bit/word/fixed pt./floating pt.	0.2/2/4/6	0.1/1/2/3	0.1/1/2/3	0.1/1/2/3	0.05/0.2/0.2/0.1
Timers/counters	128/128	256/256	256/256	256/256	512/512
Address ranges Digital channels Analog channels	266 64	1016 253	1008 248	1016 253	256 64
Interfaces MPI PROFIBUS DP PtP communication	■ — —	■ — —	■ ■ ²⁾ ASCII, 3964R ¹⁾	■ ■ ²⁾ ASCII, 3964R ¹⁾	■ ■ —
Integrated inputs/outputs DI/DO AI/AO	10/6 —	24/16 4/2	16/16 —	24/16 4/2	4/8 —
Integrated functions Counter/frequency meter Pulse outputs Controlling/positioning	2 (10 kHz) 2 (2.5 kHz) —/—	3 (30 kHz) 3 (2.5 kHz) ■/—	3 (30 kHz) 3 (2.5 kHz) ■/—	4 (60 kHz) 4 (2.5 kHz) ■/■	Technological functions, e.g. gearbox and contour synchronism, travel/time-dependent cam switching, controlled positioning
Mounting dim. WxHxD (mm)	80 x 125 x 130	120 x 125 x 130	120 x 125 x 130	120 x 125 x 130	160 x 125 x 130

■ = can be used/available
— = can not be used/not available

1) CPU 31xC-2 PtP

2) CPU 31xC-2 DP

Introduction SIMATIC Controller

SIMATIC S7-400:
For system solutions in production
technology and process engineering

SIMATIC S7-400

PLC with excellent dynamics for system solutions in the manufacturing and process technology.

Completely integrated in Totally Integrated Automation:

- Efficient configuring and programming with STEP 7 and the engineering tools.
- Networking via MPI and SIMATIC NET.

Extremely high level of performance with very short command processing times and deterministic response times. Well suited for executing programs involving many computing tasks.

Fast communication via Ethernet and efficient connection down to the field level via PROFIBUS.

Versatile module range:

- Graded CPU performance, additionally multi-computing
- Function and communication modules for technological tasks, networking and connection to the IT world

Hot swapping of the signal modules.

Efficient configuring with high-level languages, e.g. SCL, and graphical engineering tools.

Powerful diagnostics functions to achieve a higher availability of the control.

Storage of all project data (e.g. program sources) direct on the CPU to support with service jobs.

Special variants - based on the standard PLC - for applications with demands on the high availability and fail-safety as well as PC-based solutions.



Further information can be found at:
<http://www.siemens.com/simatic-s7-400>

SIMATIC S7-400 with	CPU 412-1 CPU 412-2	CPU 414-2 CPU 414-3	CPU 416-2/ 416-3/417-4	CPU 414-4H CPU 417-4H for S7-400H/FH	CPU 416F for S7-400F	
User memory for program	72 (128 ¹⁾) KB	256 (700 ²⁾) KB	1.4/2.8 ³⁾ /10 ⁴⁾ MB	700 KB	1.4 MB	
User memory for data	72 (128 ¹⁾) KB	256 (700 ²⁾) KB	1.4/2.8 ³⁾ /10 ⁴⁾ MB	700 KB	1.4 MB	
Processing time per 1 K Binary instructions	0.1 ms	0.06 ms	0.04 (0.03 ⁴⁾) ms	0.06 ms	0.03 ms	
Bit memories	4096	8192	16384	8192	16384	
Counters	2048	2048	2048	2048	2048	
Timers	2048	2048	2048	2048	2048	
Digital channels of which central	32768/32768 32768/32768	65536/65536 65536/65536	131072/131072 131072/131072	65536/65536 65536/65536	131072/131072 131072/131072	131072/131072 131072/131072
Analog channels of which central	2048/2048 2048/2048	4096/4096 4096/4096	8192/8192 8192/8192	4096/4096 4096/4096	8192/8192 8192/8192	8192/8192 8192/8192
HMI devices	■	■	■	■	■	
Communications interface	MPI (multi-point interface) PROFIBUS DP	MPI (multi-point interface) PROFIBUS DP	MPI (multi-point interface) PROFIBUS DP	MPI (multi-point interface) PROFIBUS DP	MPI (multi-point interface) PROFIBUS DP	MPI (multi-point interface) PROFIBUS DP
Networking	PROFIBUS Ind. Ethernet	PROFIBUS Ind. Ethernet	PROFIBUS Ind. Ethernet	PROFIBUS Ind. Ethernet	PROFIBUS Ind. Ethernet	PROFIBUS Ind. Ethernet
Real-time clock	integrated	integrated	integrated	integrated	integrated	

■ = can be used/available
-- = can not be used/not available

1) CPU 412-2 3) CPU 416-3
2) CPU 414-3 4) CPU 417-4

**SIMATIC C7:
PLC and OP in
one compact unit**

SIMATIC C7

Compact unit for implementing complete machine control systems incl. visualization where space is at a premium, e.g. for the manufacturing industry or simple process engineering tasks.

Low-cost solution consisting of an S7-300 CPU and a line-oriented or pixel-graphics operator panel, i.e. PLC and OP basic functionality in one device.

Compact housing that is easily installed, with permanent wiring, rugged membrane keyboard, and backlit display.

Supports Cyrillic and various Asian character sets (Chinese, Korean, Japanese).

Customized design for optimum adaptation to the machine.

Low engineering overhead with STEP 7 programming.

ProTool/WinCC flexible configuration and use of the shared data management system.

Product variants with regard to communication interfaces (MPI, DP), onboard I/O and S7-300 modules can be added, e.g. also for technological tasks.

Further information can be found at:

<http://www.siemens.com/simatic-c7>



SIMATIC C7	C7-613	C7-633/P C7-633 DP	C7-635 Key C7-635 Touch	C7-636 Key
PLC-CPU	CPU 313C	CPU 315 ¹⁾ / CPU 315-2 DP ²⁾	CPU 314C-2 DP	CPU 315-2 DP
CPU user memory	32 KB	48 ¹⁾ /64 ²⁾ KB	64 KB	128 KB
OP	---	OP 7	OP 170/ TP 170B ³⁾	OP 270
Number lines x characters per line, resolution	4 x 20	4 x 20	Pixel, vector graphics 320 x 240	Pixel, vector graphics 320 x 240
I/O	24 DI 16 DO 4 AI + 1 Pt100 2 AO	16 DI ¹⁾ 16 DO ¹⁾ 4 AI ¹⁾ 4 AO ¹⁾ 4 alarm/counter/ frequency ¹⁾	24 DI 16 DO 4 AI + 1 Pt100 2 AO	24 DI 16 DO 4 AI + 1 Pt100 2 AO
Communication interface	MPI	MPI PROFIBUS DP (Master/Slave) ²⁾	MPI PROFIBUS DP (Master/Slave)	MPI PROFIBUS DP (Master/Slave)
Programming PLC part HMI part	STEP 7 Lite, STEP 7 STEP 7 Lite, STEP 7	STEP 7 Lite ¹⁾ , STEP 7 ProTool Lite, ProTool, ProTool/Pro, WinCC flexible ²⁾	STEP 7 ProTool Lite, ProTool, ProTool/Pro	STEP 7 WinCC flexible

■ = can be used/available
 --- = can not be used/not available

1) only C7-633/P
 2) only C7-633 DP
 3) C7-635 Touch

Introduction

SIMATIC PG

SIMATIC PG:
Complete programming tools
and fully-fledged PC

Completely equipped programming tools for the SIMATIC Controllers and other automation components

- Programming software installed ready for operation
- All required interfaces and connecting cables are included

With the Windows operating system installed it is also a fully-fledged PC for all types of office applications.

Rugged, industry-standard design with high resistance to shock and vibration and immunity to interference.

SIMATIC Field PG®

Mobile and industry-standard PG in notebook computer format.

Designed mainly for commissioning, service and maintenance of automation systems.

Thanks to its compact dimensions and weight of less than 4 kg, it can be optimally used at locations where space is at a premium.

With high-performance lithium ion battery for several hours of off-mains operation.

SIMATIC Power PG®

Flexible programming workstation with powerful components from the Desktop PC segment.

Designed mainly for configuring and programming as well as simulations and tests.

With wireless full PC keyboard that can be placed anywhere on your desk.

Further information can be found at:

<http://www.siemens.com/simatic-pg>



SIMATIC PG	Field PG	Power PG
Design	Notebook computer	Mobile computer
Processor	Mobile Intel Pentium 4, 2.2 GHz incl. 512 KB 2nd level cache;	Mobile Intel Pentium 4, 2.2 GHz incl. 512 KB 2nd level cache
Main memory	256 MB, can be expanded to max. 1 GB	512 MB, can be expanded to max. 1.5 GB
Display	14.1" TFT, resolution 1024 x 768 optional 1400 x 1050	15" TFT, resolution 1024 x 768 optional 1400 x 1050
PC slots	--	2 x PCI (1 x long, 1 x short)
Keyboard	Notebook keyboard without numeric pad	Wireless, standard keyboard with numeric pad
Hard disk	40 GB, optional 80 GB; 2.5"	80 GB; 3.5"
DVD-ROM/CD-ROM	DVD-ROM/CD-RW drive optional DVD-ROM/DVD-R/-RW drive	
SIMATIC interfaces	1 x MPI/DP	
PC interfaces	PCMCIA, 1 x Type III or 2 x Type II 1 x COM 1 1 x COM 2 2 x USB 2.0 1 x Fast Ethernet 10/100 MB/s 1 x LPT	

Introduction

SIMATIC PC

**SIMATIC PC:
Always the right
industrial PC**

Professional automation solutions place varying, high demands on the industrial PCs used - vibration, low temperatures, heat, steam - year after year and around the clock. SIMATIC PCs are the ideal industry-standard PC platforms for this environment. SIMATIC PCs can offer

- high system availability,
- high investment protection,
- excellent industrial functionality.

A wide range of different designs is available for different applications:

SIMATIC Box PC

Compact and rugged industrial PC for installation direct at the machine.

SIMATIC Rack PC

Flexible industrial PC for installation in 19" cabinets.

SIMATIC Panel PC

Compact industrial PC for operator control and monitoring direct on site. SIMATIC PCs can be individually configured. Special customer requests, for example regarding design, and hardware expansions can be implemented project-specifically. For individually expanding the system availability, there are add-on components that are perfectly matched to each other. SIMATIC PCs are the ideal platform for PC-based automation and can be used in the manufacturing and process industry as well as in semi-industrial applications, such as transport systems, building management systems and warehouse systems.

Further information can be found at:

<http://www.siemens.com/simatic-pc>



Box PC	Rack PC	Panel PC
SIMATIC Microbox PC 420 Ultra-compact for use directly at the machine Maintenance-free thanks to operation without fan and hard disk PC components from the Intel Embedded line with long-term availability Scalable and expandable with up to 3 PCI/104/Plus modules High system availability by rugged, EMC-suitable design Long-term availability of spare parts	SIMATIC Rack PC Industrial Lite 40 S High performance and scalability PCI- and AGP-Slots CE marking for industry and office Dust protection Service-friendly Transportation lock for expansion cards Monitoring functions Long-term availability of spare parts	SIMATIC Panel PC Industrial Lite 70 and 77 Low-cost entry-level version for basic industrial requirements Basic industrial capability: vibration load 0.25 g, shock 1.0 g (in operation) High electromagnetic compatibility: CE marking for industrial applications Latest PC technology PCI slots
SIMATIC Box PC 620 and 840 High-performance processor Maximum compactness and performance Can be operated at high temp. levels Powerful diagnostics Integrated PROFIBUS/MPI interface (optional) ISA- and PCI-Slots High flexibility and expandability with the components Long-term availability of spare parts	SIMATIC Rack PC 840 Protection against vibration/shock during operation Can be operated at high temp. levels Efficient self-diagnostics Integrated PROFIBUS/MPI interface (optional) ISA- and PCI-Slots High flexibility and expandability with the components Long-term availability of spare parts	SIMATIC Panel PC 670 and 870 Rugged high-performance PC High industrial capability: vibration load 1.0 g, shock 5.0 g (in operation) High electromagnetic compatibility: CE marking for industrial applications High industrial functionality: PROFIBUS/MPI integrated, Ethernet on board ISA and PCI slots Low mounting depth (Panel PC 670), Maximum expandability (Panel PC 870) Optional direct control key module Distributed configuration (optional) PC diagnostics/signaling software Second hard disk (optional)

Introduction

SIMATIC Industrial Software

The future-oriented software basis

SIMATIC Industrial Software is one of the main components of Totally Integrated Automation and offers the perfect tool for any automation task and project phase. Whether in manufacturing or process technology, in mechanical or plant engineering, with SIMATIC Industrial Software you can tap the full engineering workflow potential.

- Fewer interfaces thanks to the integrated engineering environment for logic modules, HMI, motion control and process technology.
- Fast implementation of the process design in the automation structure thanks to system-wide engineering from a central control point.
- Shorter design and implementation times thanks to structured, process-oriented programming methodology.
- Reduced overhead for follow-up projects thanks to modules that can be easily re-used.
- Less overhead for entering data and no inconsistencies thanks to a shared database.
- Less overhead thanks to user-friendly configuring instead of programming.
- Shorter training periods for the programming and maintenance personnel thanks to intuitive operation and the use of standard languages.
- Application software can be transferred thanks to the shared engineering environment for PLC- and PC-based solutions.
- Increased plant availability thanks to efficient process diagnostics.

Standard Tools

- STEP 7, the basic engineering platform for all SIMATIC Controllers.
- STEP 7 Professional, the comprehensive Engineering Suite for all SIMATIC Controllers.
- STEP 7 Lite, the low-cost, entry-level software.



Engineering Tools

- SIMATIC iMap, software for Component based Automation.
- S7-HiGraph, state diagrams.
- CFC, function charts.
- Distributed Safety Software, configuring of failsafe applications
- DOCPRO, generation of plant documentation.
- S7-PDIAG, process diagnostics.
- TeleService, remote maintenance and remote interfacing.
- D7-SYS, configuring of closed-loop control tasks.

Further information can be found at:

<http://www.siemens.com/simatic-software>

Introduction

SIMATIC PC-based Control and Embedded Control

WinAC –
The SIMATIC S7
in the PC

PC-based Control

SIMATIC WinAC supplements SIMATIC S7 with PC-based controls. It is used when different tasks, such as data processing, communication, visualization and technology, are to be integrated on one PC.

SIMATIC WinAC is available in two basic versions:

- **SIMATIC WinAC Software PLCs** for tasks that require high flexibility and openness.
- **SIMATIC WinAC Slot PLCs** if the focus is on PC-independent operation, availability and high operational reliability.

With the open and powerful interfaces, SIMATIC WinAC is the ideal **platform for tailor-made automation solutions**.

SIMATIC WinAC hardware and software can be used on SIMATIC PCs and most commercially available PCs with the Professional versions of Windows 2000/XP.

SIMATIC WinAC can be easily combined with components from other manufacturers and can be integrated into the Office world over the standard interface OPC (OLE for Process Control).

Furthermore, SIMATIC WinAC permits easy horizontal integration of technological applications. For this purpose, the ODK (Open Development Kit) permits the integration of C++ programs into the WinAC control program and thus access to all hardware and software components of the PC.

Programming of WinAC is implemented with the standard SIMATIC programming tools - with STEP 7 or, if required, with the tried and tested engineering tools. SIMATIC WinAC is code-compatible with SIMATIC S7-400, i.e. program sections generated for SIMATIC S7-300 and S7-400 can continue to be used in WinAC and vice versa.

SIMATIC WinCC and ProTool/Pro can be connected via a SIMATIC interface to be able to use the comprehensive diagnostics functionality and the shared database, for example. The PG/OP communication permits the connection of SIMATIC programming devices and operator panels.



Embedded Control

With WinAC Embedded Control, a new class of devices for control and visualization at the machine level on one platform is added to the SIMATIC product range.

SIMATIC WinAC MP is the soft PLC under Windows CE and runs on the MP370 multi-functional platform. WinAC MP is the most economical solution for deterministic processes in connection with a rugged hardware platform. It is also ideal for data-intensive tasks.

The SIMATIC MP370 provides the cost-optimized, rugged hardware platform and the visualization software for this purpose. The operator panels and programmable logic controllers are designed without a hard disk and fan and are thus real-time capable and deterministic.

Further information can be found at:

<http://www.PCbasedAutomation.de>

Introduction SIMATIC DP

The fast
fieldbus as
system bus

Distributed I/O

Decentralized structures are widely accepted because they are more flexible, easier, and many times more cost-effective. In this context, an integrated concept has been implemented with SIMATIC in connection with the PROFIBUS fieldbus which permits extremely high system performance.

Furthermore, PROFIBUS offers trend-setting innovations:

- PROFIsafe for transmitting safety-relevant signals over the fieldbus
- With PROFIdrive for Motion Control, the fieldbus becomes a drive bus as well
- PROFINET - the innovative and open Industrial Ethernet standard for industrial automation from the field level right up to the management level.

The system is **integrated**: SIMATIC does not differentiate any longer between centralized and distributed I/O. One software package suffices for implementing hardware configuration, parameterization, tests, commissioning and documentation of all components. You can program and diagnose online from any location in the plant. Drives are also perfectly integrated into this concept.

The system is **powerful**: The interfaces have been integrated into a number of controller CPUs. This type of connection avoids the execution times at the interface and the backplane bus and saves space and costs while retaining full performance and speed.

I/O devices with distributed intelligence accept CPU tasks on site and off-load the central control even more.

In addition to I/O devices with distributed intelligence, drives communicate as slaves over PROFIBUS DP.

The Drive Engineering System (Drive ES) is totally integrated in the SIMATIC Manager and permits easy and fast integration of drives in the SIMATIC environment.

Thanks to the new functions of PROFIBUS DP - operation in isochrone mode for open-loop control and synchronization of drives via the bus, and internode communication for direct communication between drives and I/O - Motion Control tasks can be implemented on different hardware platforms (e.g. PC, PLC, or drive).

Different converter series are available depending on the drive task:

- SIMOTION C/P/D
- SINAMICS
- MICROMASTER/COMBIMASTER
- SIMODRIVE 611 universal
- SIMODRIVE POSMO
- Intelligent drives SIMOVERT MASTERDRIVES

The System is **flexible**:

Additional bus systems can be connected using couplers, e.g. the binary networking system AS-Interface, the bus system PROFIBUS PA for applications in hazardous areas or, of course, Industrial Ethernet/PROFINET.

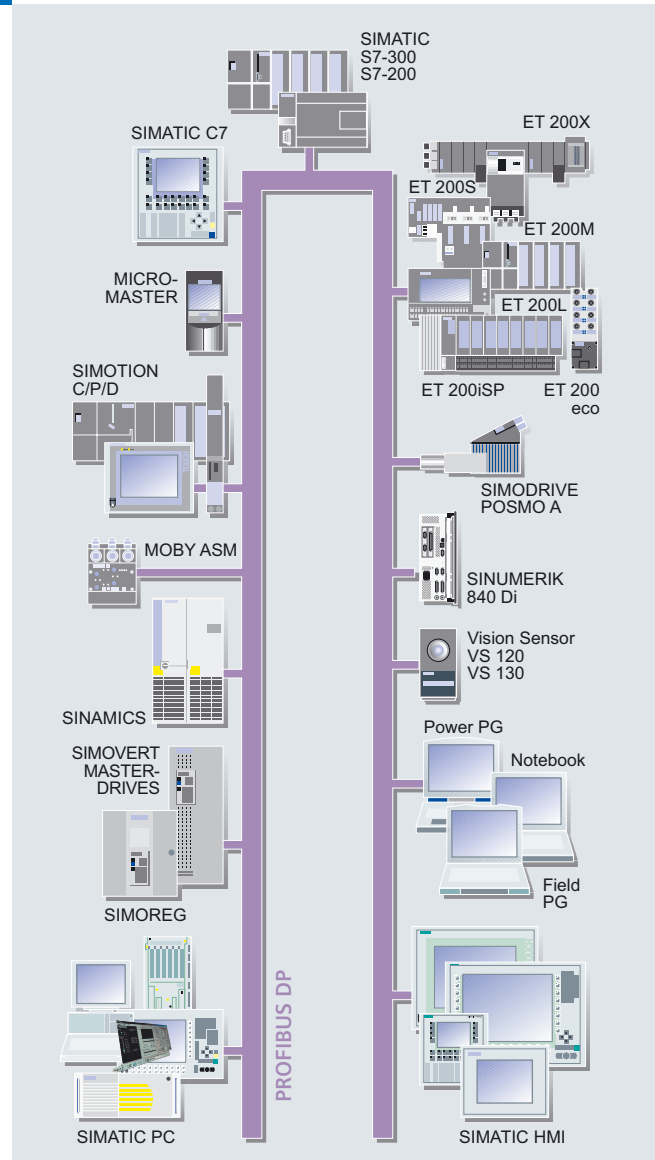

A comprehensive range of distributed I/O devices is available.

SIMATIC ET 200 can offer the right device for any application:

- ET 200M, ET 200S, ET 200L for the control cabinet with IP20 degree of protection.
- ET 200iSP for hazardous areas (IP30)
- ET 200X. ET 200R, ET 200eco for cabinet-less distributed configurations with IP65/67 degree of protection.
- ET 200 also integrate pneumatic connection, CPU performances, technology functions, motor starters, frequency converters, or even safety technology.

Further information can be found at:

<http://www.siemens.com/simatic-dp>

Introduction

SIMATIC HMI

Maintaining the overview easily

To maintain the overview, operator control and monitoring systems are becoming increasingly important - also in the lower performance range.

In this context SIMATIC is relying heavily, within the framework of Totally Integrated Automation, on the SIMATIC HMI system family - from Panels over PC-based single-user systems right up to networked Client-Server structures.

The HMI systems request the process data required for their configured sequence diagrams from the SIMATIC controller. The transfer is then implemented fully automatically and does not need to be included in the user program.

The configuration of the operator panels **at machine level** from the smallest Micro Panel to the PC, is executed with **WinCC flexible** (or ProTool). WinCC flexible considerably increases the efficiency of configuration in this case.

WinCC flexible is based on the latest software technologies and supports the project engineer with its user-friendly operator interface, libraries with pre-generated objects and picture blocks and intelligent tools. Text export/import and automatic translation permit the generation of multi-language configurations.

Additional options permit that new innovative automation concepts and additional service and maintenance functions are added to the application range of the SIMATIC operator panels and PC-based single-user systems.

TCP/IP communication permits that each operator panel can access the other to obtain variables and pictures. Thus operator panels with plant-wide access to process values and pictures, distributed operator panels on large, geographically separated machines, or simple local control station solutions can be implemented.

Event-triggered forwarding of emails, diagnostic functions, remote operation of local control stations over the intranet/Internet, as well as service and maintenance functions accelerate the entire process sequence from the disturbance to fault clearance.

Existing ProTool projects can be integrated or converted without a problem and ensure continued investment protection of prior engineering services.

The Runtime software **WinCC flexible Runtime** is used for PC-based single-user solutions at the machine level under Windows 2000/XP. It includes the visualization and signaling components and can be expanded as required using option packages.

SIMATIC WinCC from the SIMATIC HMI product range is available as PC-based process visualization system.

SIMATIC WinCC can be used as single-user system or in networked Client-Server configurations as multi-user system under Windows 2000/XP. Software packages, graded according to the number of variables, and option packages

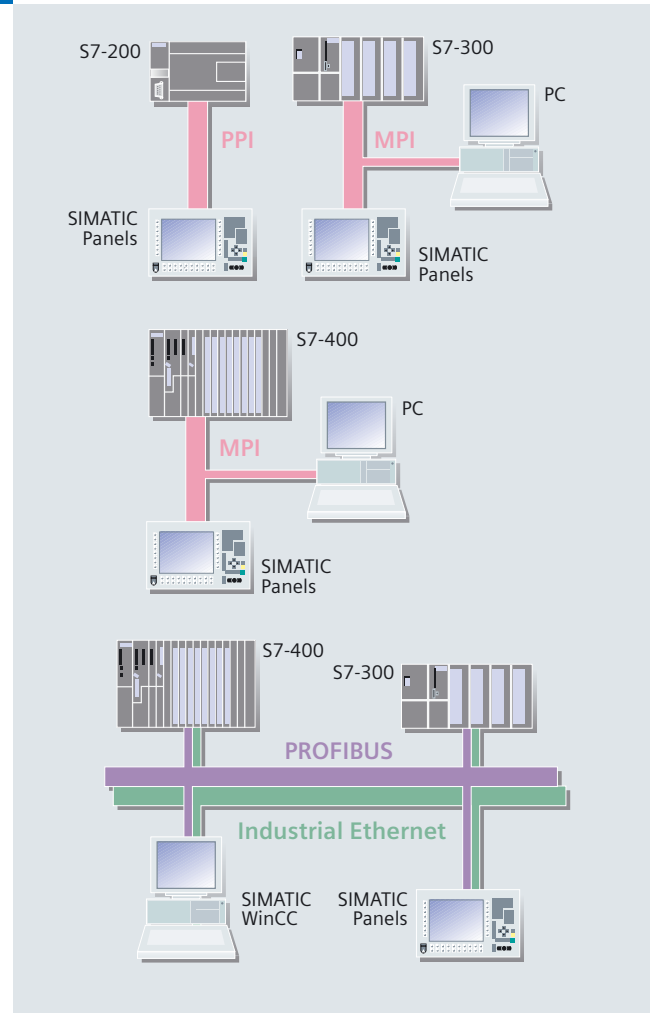

offer individual connection options in case of increasing quantity structures and functional expansions.

Archive data are stored in a relational database (MS SQL Server 2000) and can be read from there, e.g. over OLE-DB.

Applications executing parallel with WinCC, e.g. MS Excel, can request process data via open standard interfaces.

Furthermore, commercially available OCX (OLE Custom Controls) can be integrated.

Thanks to the Windows-compliant operator interface, fast and easy configuring is possible, e.g. integration of existing standard and application programs. Online configuring permits modifications on site without interrupting the ongoing operator control and monitoring process.

Further information can be found at:

<http://www.siemens.com/simatichmi>

Introduction SIMATIC PCS 7

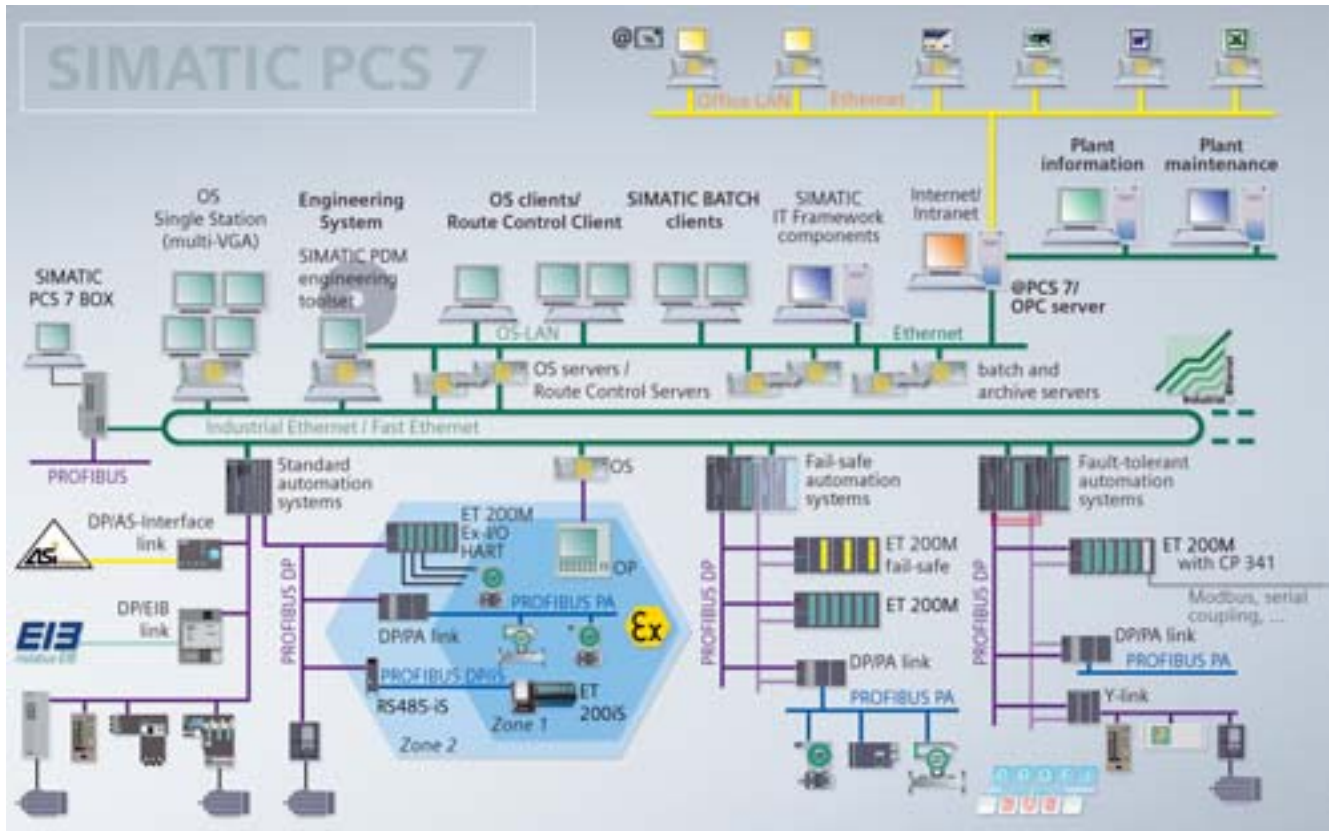

SIMATIC PCS 7 – The process control system from Totally Integrated Automation

With Totally Integrated Automation (TIA), Siemens offers integrated automation technology for the entire process sequence based on one single platform, from incoming goods to production and primary processes and downstream processes (secondary processes) all the way to outgoing goods. This integrated automation technology has the purpose of optimizing all operating procedures within a company, from the Enterprise Resource Planning (ERP) level over the Management Execution System (MES) level and Control level right down to the field level.

Horizontal integration

Horizontal integration means that uniform standard hardware and software components from the SIMATIC product range are used for the entire production process - from incoming goods to primary processes and downstream processes (secondary processes) all the way to outgoing goods.

As the process control system in the enterprise-wide automation network Totally Integrated Automation, SIMATIC PCS 7 utilizes selected standard hardware and software components from the TIA modular system. With its integrated data management, communication and configuration, it also provides an open platform for modern, future-oriented and economic automation solutions in all sectors of the process industry, manufacturing industry and hybrid industry (combination of continuous/batch processes and discrete manufacturing, e.g. in the glass or pharmaceutical industries).

While secondary and logistics processes in the process and hybrid industry are frequently automated by Motion Control and SIMATIC components, the SIMATIC PCS 7 process control system takes over when it comes to primary processes.

In the TIA network, SIMATIC PCS 7 does not only handle the usual process control tasks, but it can also automate secondary processes (e.g. filling, packaging) or incoming goods and outgoing goods logistics (e.g. material supply, storage) for a production site.

Vertical integration

A characteristic of vertical integration is the integrated and transparent data communication from the ERP level over the MES level and control level right down to the field level. It is characterized by the increasing amalgamation of automation technology and information technology and their standards in the course of establishing company-wide information networks. This permits the modularization and standardization of entire subprocesses and thus a considerable increase in production flexibility.

The vertical integration of SIMATIC PCS 7 into the company environment comprises two aspects:

- Integration into the company-wide information network and
- Integration of field technology.

By linking the automation level with the IT world, process data are made available company-wide for evaluation, planning, coordination, and optimization of operating procedures as well as production and business processes. At the same time the requirements of international and distributed companies are considered.

SIMATIC PCS 7 relies on PROFIBUS technology for integrating distributed field systems. The PROFIBUS is simple, rugged and reliable and is used worldwide in all sectors of the process, manufacturing and hybrid industry - for incoming and outgoing goods logistics as well as for primary and secondary processes. It supports redundancy and fail-safety as well as online extendibility and can be used in standard environments as well as in hazardous areas, whereby it does not matter whether the plant is equipped with classical signal inputs and outputs at the remote I/O ET 200 or with the state-of-the-art field devices.

Further information can be found at:

<http://www.siemens.com/simatic-pcs7>

and in the ST PCS 7 Catalog.



Introduction SIMATIC NET

Networking for
Industry

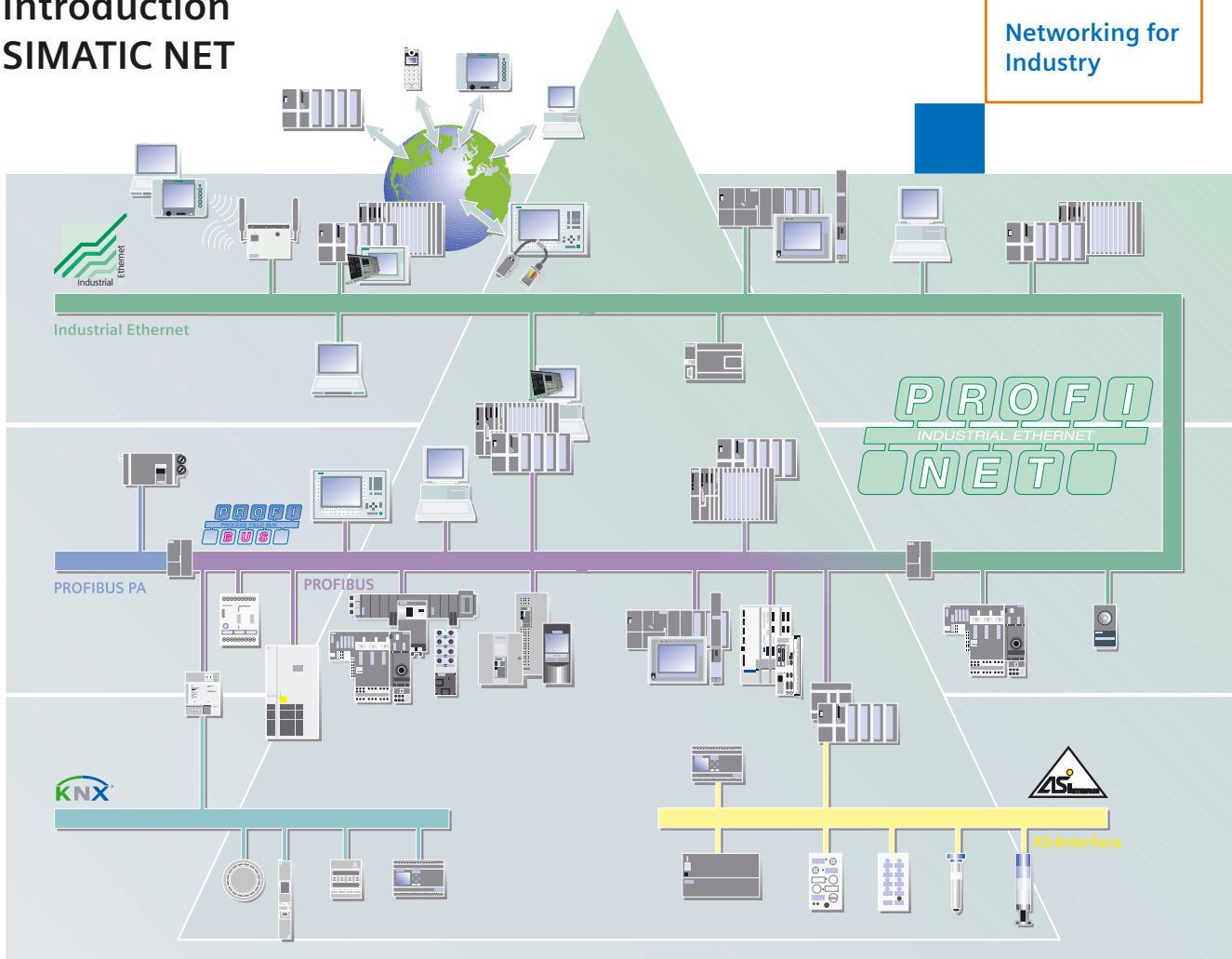

Communication

Communications networks are an important component of automation solutions. SIMATIC NET Networking for Industry offers a wide range of modular components - designed for industry - to solve your communications tasks efficiently:

- For the different automation tasks
- Throughout the entire workflow.
- Throughout the plant's entire life cycle.
- For all sectors.

SIMATIC NET offers solutions that not only utilize the benefits of Ethernet, but also easily integrate fieldbus systems.

Some prominent examples are:

- Making the field level available for Industrial Ethernet applications.
- Uniformity from the field level right up to the corporate management level.
- Pushing ahead with mobile communication.
- Integration of IT technologies.

SIMATIC NET supports the following bus systems:

Industrial Ethernet (IEEE 802.3 and 802.11) – today the international standard for area networking is the global No. 1 network in the LAN sector with a share of over 80 %.

High-performance communications networks spanning large distances can be created over Industrial Ethernet.

The international **PROFINET** standard uses Industrial Ethernet and permits real-time communication down to the field level. If existing IT standards are completely utilized, PROFINET also permits Motion Control applications on Industrial Ethernet in isochrone mode.

PROFIBUS (IEC 61158/EN 50170) – the international standard for the field level is the global market leader in the fieldbus area. As only fieldbus it permits communication both in production- and process-oriented applications.

AS-Interface (IEC 62026-2/EN 50295) – as low-cost alternative to the cable harness, AS-Interface links sensors and actuators over a two-wire line.

KNX (EN 50090, ANSI EIA 776) – the global standard KNX is the basis for building automation. Network transitions are implemented via controls or links.

Further information can be found at:

<http://www.siemens.com/simatic-net>

LOGO! logic module



2/2	Introduction
2/2	LOGO! logic module
2/3	LOGO! modular
2/3	LOGO! modular basic variants
2/5	LOGO! modular pure variants
2/7	LOGO! modular expansion modules
2/10	LOGO! CM EIB/KNX communication module
2/11	AS-Interface connection for LOGO!
2/12	LOGO!Power
2/12	LOGO!Power 12 V
2/14	LOGO!Power 24 V
2/16	LOGO!Contact
2/17	LOGO! Software

Overview



LOGO! logic module

- The compact, easy-to-use and low-cost solution for simple control tasks
- Compact, easy to operate, universally applicable without accessories
- "All in one": Integrated display and operator panel
- 34 different functions can be linked by pressing a key or with PC software; up to a total of 130 times
- Functions can be changed easily at the touch of a button. No need for complex and time-consuming rewiring

SIPLUS LOGO! logic module

- The PLC for use in the harshest environmental conditions
- With extended temperature range from -25 to +70°C
- Suitable for extraordinary medial load (pollution gas atmosphere)
- Occasional short-term condensation and increased mechanical loading permissible
- With the proven PLC technology of the S7-200
- Convenient handling, programming, maintenance and service
- Ideal for use in the automotive industry, environmental technology, mining, chemical plants, production technology, food industry etc.
- The alternative to expensive custom solutions

More Information you can find at:

<http://www.siemens.com/siplus>

General technical specifications SIPLUS LOGO!

Ambient temperature	
Temperature	Horizontal mounting: -25 °C to 70 °C Vertical mounting: -25 °C to 50 °C
Relative humidity	5 to 95%; transient condensation permissible, corresponding to relative humidity (RH-) stress grade 2 according to IEC 1131-2 and IEC 721 3-3 Cl. 3K5
Transient icing	-25 °C to 0 °C IEC 721 3-3 Cl. 3K5
Atmospheric pressure	1080 to 795 hPa corresponding to a height of -1000 to 2000 m
Pollutant concentration	SO ₂ : < 0,5 ppm; relative humidity <60% Test: 10 ppm, 4 days H ₂ S: < 0,1 ppm; relative humidity <60% Test: 1 ppm, 4 days (according to IEC 721 3-3; Class 3C3)
Mechanical environmental conditions	
Vibrations	Type of vibration: frequency progressions changing at 1 octave per minute. 2 Hz ≤ f ≤ 9 Hz, constant amplitude 3,0 mm 9 Hz ≤ f ≤ 150 Hz, constant acceleration 1 g; Duration of vibration: 10 frequency progressions per axis in each direction of the three mutually perpendicular axes; Vibration testing according to IEC 68 section 2-6 (Sinus) and IEC 721 3-3, Class 3M4
Shock	Type of shock: semisinusoidal shock strength: 15 g peak value, duration shock direction 11 ms: 3 shocks each in +/- direction on each of the mutually perpendicular axes Shock testing according to IEC 68 section 2-27
Conformity	EN 50155 (railroad applications - electrical device on rail vehicles)

Overview



- The space-saving basic versions
- With interface for connection of expansion modules

Technical specifications

	6ED1 052-1CC00-0BA4	6ED1 052-1MD00-0BA4	6ED1 052-1HB00-0BA4	6ED1 052-1FB00-0BA4
Supply voltages				
Rated value				
- 12 V DC		Yes		
- 24 V DC	Yes	Yes	Yes	
- 115 V DC				Yes
- 230 V DC				Yes
- permissible range, lower limit (DC)	20.4 V	10.8 V	20.4 V	100 V
- permissible range, upper limit (DC)	28.8 V	28.8 V	28.8 V	253 V
- 115 V AC				Yes
- 230 V AC				Yes
- permissible range, lower limit (AC)			20.4 V	85 V
- permissible range, upper limit (AC)			26.4 V	265 V
Time				
Time switches				
- Reserve power		80 h	80 h	80 h
•Number of digital inputs	8; of which 2 can be for analog use (0..10V)	8; of which 2 can be for analog use (0..10V)	8	8
Digital outputs				
•Number of digital outputs	4; Transistor	4; Relay	4; Relay	4; Relay
•Short-circuit protection of the output	Yes; electric (1 A)	No; external fusing required	No; external fusing required	No; external fusing required
Relay outputs				
Switching capacity of the contacts				
- at inductive load, max.		3 A	3 A	3 A
- at resistive load, max.	0.3 A	10 A	10 A	10 A
EMC				
•Emission of radio interference to comply with EN 55 011 (limit class B)	Yes	Yes	Yes	Yes
Environmental requirements				
Operating temperature				
- min.	0 °C	0 °C	0 °C	0 °C
- max.	55 °C	55 °C	55 °C	55 °C
Degree of protection and class of protection				
- IP 20	Yes	Yes	Yes	Yes

LOGO! logic module

LOGO! modular

2

LOGO! modular basic variants

Technical specifications (Continued)

	6ED1 052-1CC00-0BA4	6ED1 052-1MD00-0BA4	6ED1 052-1HB00-0BA4	6ED1 052-1FB00-0BA4
Standards, approvals, certification				
•CSA approval	Yes	Yes	Yes	Yes
•Developed to comply with IEC1131	Yes	Yes	Yes	Yes
•FM approval	Yes	Yes	Yes	Yes
•To comply with VDE 0631	Yes	Yes	Yes	Yes
•Shipbuilding approval	Yes	Yes	Yes	Yes
•UL approval	Yes	Yes	Yes	Yes
Dimensions and weight				
•Installation	on 35 mm DIN rail 4 modules wide	on 35 mm DIN rail 4 modules wide	on 35 mm DIN rail 4 modules wide	on 35 mm DIN rail 4 modules wide
•Width	72 mm	72 mm	72 mm	72 mm
•Height	90 mm	90 mm	90 mm	90 mm
•Depth	55 mm	55 mm	55 mm	55 mm

Ordering Data

	Order No.
LOGO! 24 Power supply 24 V DC, 8 digital inputs 24 V DC, of which 2 can be used in analog mode (0 to 10 V), 4 digital outputs 24 V DC, 0.3 A; 130 function blocks connectable, expandable by modular system	6ED1 052-1CC00-0BA4
LOGO! 12/24RC logic module Power supply 12/24 V DC, 8 digital inputs 12/24 V DC, of which 2 can be used in analog mode (0 to 10 V), 4 relay outputs 10 A, integral time switch; 130 function blocks connectable, expandable by modular system	6ED1 052-1MD00-0BA4
LOGO! 24RC logic module Power supply 24 V AC/DC, 8 digital inputs 24 V AC/DC, 4 relay outputs 10 A, integral time switch; 130 function blocks connectable, expandable by modular system	6ED1 052-1HB00-0BA4
LOGO! 230RC logic module Power supply 115/230 V AC/DC, 8 digital inputs 115/230 V AC/DC, 4 relay outputs 10 A, integral time switch; 130 function blocks connectable, expandable by modular system	6ED1 052-1FB00-0BA4

Order No.

Accessories

LOGO! Manual German English French spanisch italienisch	6ED1 050-1AA00-0AE5 6ED1 050-1AA00-0BE5 6ED1 050-1AA00-0CE5 6ED1 050-1AA00-0DE5 6ED1 050-1AA00-0EE5
LOGO! Memory card for copying, with know-how protection	6ED1 056-5CA00-0BA0
LOGO!Soft Comfort V4.0^{B)} for programming on the PC in LAD/FBD; executes with Windows 95 onwards, Linux, MAC OSX; on CD-ROM	6ED1 058-0BA00-0YA0
LOGO!Soft Comfort Upgrade^{B)} V1.0 upwards to V4.0	6ED1 058-0CA00-0YE0
LOGO! PC cable for program transmission between LOGO! and PC	6ED1 057-1AA00-0BA0
LOGO! News Box, 12/24 V contains LOGO! 12/24RC, LOGO! PC cable, LOGO!Soft Comfort, Tips&Tricks manual, screwdriver, info material German ^{C)} English ^{C)}	6ED1 057-3BA00-0AA3 6ED1 057-3BA00-0BA3
LOGO! News Box, 230 V contains LOGO! 230RC, LOGO! PC cable, LOGO!Soft Comfort, Tips&Tricks manual, screwdriver, info material German ^{C)} English ^{C)}	6ED1 057-3AA00-0AA8 6ED1 057-3AA00-0BA8

B) Subject to export regulations: AL: N and ECCN: EAR99S

C) Subject to export regulations: AL: N and ECCN: EAR99T

Overview



- The basic versions at optimum cost
- With integrated interface for the connection of expansion modules

Technical specifications

	6ED1 052-2CC00-0BA4	6ED1 052-2MD00-0BA4	6ED1 052-2HB00-0BA4	6ED1 052-2FB00-0BA4
Supply voltages				
Rated value				
- 12 V DC		Yes		
- 24 V DC	Yes	Yes	Yes	
- 115 V DC				Yes
- 230 V DC				Yes
- permissible range, lower limit (DC)	20.4 V	10.8 V	20.4 V	100 V
- permissible range, upper limit (DC)	28.8 V	28.8 V	28.8 V	253 V
- 115 V AC				Yes
- 230 V AC				Yes
- permissible range, lower limit (AC)			20.4 V	85 V
- permissible range, upper limit (AC)			26.4 V	265 V
Time				
Time switches				
- Number		8	8	8
- Reserve power		80 h	80 h	80 h
•Number of digital inputs	8; of which 2 can be for analog use (0..10V)	8; of which 2 can be for analog use (0..10V)	8	8
Digital outputs				
•Number of digital outputs	4; Transistor	4; Relay	4; Relay	4; Relay
•Short-circuit protection of the output	Yes; electric (1 A)	No; external fusing required	No; external fusing required	No; external fusing required
Relay outputs				
Switching capacity of the contacts				
- at inductive load, max.		3 A	3 A	3 A
- at resistive load, max.	0.3 A	10 A	10 A	10 A
EMC				
•Emission of radio interference to comply with EN 55 011 (limit class B)		Yes	Yes	Yes
Environmental requirements				
Operating temperature				
- min.	0 °C	0 °C	0 °C	0 °C
- max.	55 °C	55 °C	55 °C	55 °C
Degree of protection and class of protection				
- IP 20	Yes	Yes	Yes	Yes

LOGO! logic module

LOGO! modular

2

LOGO! modular pure variants

Technical specifications (Continued)

	6ED1 052-2CC00-0BA4	6ED1 052-2MD00-0BA4	6ED1 052-2HB00-0BA4	6ED1 052-2FB00-0BA4
Standards, approvals, certification				
•CSA approval	Yes	Yes	Yes	Yes
•Developed to comply with IEC1131	Yes	Yes	Yes	Yes
•FM approval	Yes	Yes	Yes	Yes
•To comply with VDE 0631	Yes	Yes	Yes	Yes
•Shipbuilding approval	Yes	Yes	Yes	Yes
•UL approval	Yes	Yes	Yes	Yes
Dimensions and weight				
•Installation	on 35 mm DIN rail 4 modules wide	on 35 mm DIN rail 4 modules wide	on 35 mm DIN rail 4 modules wide	on 35 mm DIN rail 4 modules wide
•Width	72 mm	72 mm	72 mm	72 mm
•Height	90 mm	90 mm	90 mm	90 mm
•Depth	55 mm	55 mm	55 mm	55 mm

Ordering Data

	Order No.
LOGO! 24o logic module Power supply 24 V DC, 8 digital inputs 24 V DC, of which 2 can be used in analog mode (0 to 10 V), 4 digital outputs 24 V DC, 0.3 A; without display and keyboard; 130 function blocks connectable, expandable by modular system	6ED1 052-2CC00-0BA4
LOGO! 12/24RCo logic module Power supply 12/24 V DC, 8 digital inputs 12/24 V DC, of which 2 can be used in analog mode (0 to 10 V), 4 relay outputs 10 A, integral time switch; without display and keyboard; 130 function blocks connectable, expandable by modular system	6ED1 052-2MD00-0BA4
LOGO! 24RCo logic module Power supply 24 V AC/DC, 8 digital inputs 24 V AC/DC, 4 relay outputs 10 A, integral time switch; without display and keyboard; 130 function blocks connectable, expandable by modular system	6ED1 052-2HB00-0BA4
LOGO! 230RCo logic module Power supply 115/230 V AC/DC, 8 digital inputs 115/230 V AC/DC, 4 relay outputs 10 A, integral time switch; without display and keyboard; 130 function blocks connectable, expandable by modular system	6ED1 052-2FB00-0BA4

Order No.

Accessories

LOGO! Manual

German
English
French
Spanish
Italian

6ED1 050-1AA00-0AE5
6ED1 050-1AA00-0BE5
6ED1 050-1AA00-0CE5
6ED1 050-1AA00-0DE5
6ED1 050-1AA00-0EE5

LOGO! Memory Card

for copying, with know-how protection

6ED1 056-5CA00-0BA0

LOGO!Soft Comfort V4.0 ^{B)}

for programming on the PC in LAD/FBD; executes with Windows 95 onwards, Linux, MAC OSX; on CD-ROM

6ED1 058-0BA00-0YA0

LOGO!Soft Comfort Upgrade ^{B)}

V1.0 upwards to V4.0

6ED1 058-0CA00-0YE0

LOGO! PC cable

for program transmission between LOGO! and PC

6ED1 057-1AA00-0BA0

LOGO! News Box, 12/24 V

contains LOGO! 12/24RC, LOGO! PC cable, LOGO!Soft Comfort, Tips&Tricks manual, screwdriver, info material

German ^{C)}
English ^{C)}

6ED1 057-3BA00-0AA3
6ED1 057-3BA00-0BA3

LOGO! News Box, 230 V

contains LOGO! 230RC, LOGO! PC cable, LOGO!Soft Comfort, Tips&Tricks manual, screwdriver, info material

German ^{C)}
English ^{C)}

6ED1 057-3AA00-0AA8
6ED1 057-3AA00-0BA8

B) Subject to export regulations: AL: N and ECCN: EAR99S

C) Subject to export regulations: AL: N and ECCN: EAR99T

Overview



- Expansion modules for the connection to LOGO! semi-modular
- With digital inputs and outputs or analog inputs

Technical specifications

	6ED1 055-1CB00-0BA0	6ED1 055-1HB00-0BA0	6ED1 055-1MB00-0BA1	6ED1 055-1FB00-0BA1
Supply voltages				
Rated value			Yes	
- 12 V DC	Yes	Yes	Yes	
- 24 V DC				Yes
- 115 V DC				Yes
- 230 V DC				Yes
- permissible range, lower limit (DC)	20.4 V	20.4 V	10.8 V	100 V
- permissible range, upper limit (DC)	28.8 V	28.8 V	28.8 V	253 V
- 115 V AC				Yes
- 230 V AC				Yes
- permissible range, lower limit (AC)		20.4 V		85 V
- permissible range, upper limit (AC)		26.4 V		265 V
Digital inputs				
•Number of digital inputs	4	4	4	4
Digital outputs				
•Number of digital outputs	4	4; Relay	4; Relay	4; Relay
•Short-circuit protection of the output	Yes; electric (1 A)	No; external fusing required	No; external fusing required	No; external fusing required
Relay outputs				
Switching capacity of the contacts				
- at inductive load, max.		3 A	3 A	3 A
- at resistive load, max.		5 A	5 A	5 A
- Continuous thermal current, max.	0.3 A			
EMC				
•Emission of radio interference to comply with EN 55 011 (limit class B)	Yes	Yes	Yes	Yes
Environmental requirements				
Operating temperature				
- min.	0 °C	0 °C	0 °C	0 °C
- max.	55 °C	55 °C	55 °C	55 °C
Degree of protection and class of protection				
- IP 20	Yes	Yes	Yes	Yes

Technical specifications (Continued)

	6ED1 055-1CB00-0BA0	6ED1 055-1HB00-0BA0	6ED1 055-1MB00-0BA1	6ED1 055-1FB00-0BA1
Standards, approvals, certification				
•CSA approval	Yes	Yes	Yes	Yes
•Developed to comply with IEC1131	Yes	Yes	Yes	Yes
•FM approval	Yes	Yes	Yes	Yes
•To comply with VDE 0631	Yes	Yes	Yes	Yes
•Shipbuilding approval	Yes	Yes	Yes	Yes
•UL approval	Yes	Yes	Yes	Yes
Dimensions and weight				
•Installation	on 35 mm DIN rail, 2 modules wide	on 35 mm DIN rail, 2 modules wide	on 35 mm DIN rail, 2 modules wide	on 35 mm DIN rail, 2 modules wide
•Width	36 mm; 2 TE	36 mm; 2 TE	36 mm; 2 TE	36 mm; 2 TE
•Height	90 mm	90 mm	90 mm	90 mm
•Depth	55 mm	55 mm	55 mm	55 mm
Supply voltages				
Rated value				
- 12 V DC	Yes		Yes	
- 24 V DC	Yes		Yes	
Analog inputs				
•Number of analog inputs	2		2	
Input ranges (rated values), voltages				
- Voltage	Yes			
- 0 to +10 V	Yes			
Input ranges (rated values), currents				
- Current	Yes			
- 0 to 20 mA	Yes			
- Resistance thermometer			Yes	
- Pt 100			Yes	
EMC				
•Emission of radio interference to comply with EN 55 011 (limit class B)	Yes		Yes	
Environmental requirements				
Operating temperature				
- min.	0 °C		0 °C	
- max.	55 °C		55 °C	
Degree of protection and class of protection				
- IP 20	Yes		Yes	
Standards, approvals, certification				
•CSA approval	Yes		Yes	
•Developed to comply with IEC1131	Yes		Yes	
•FM approval	Yes		Yes	
•To comply with VDE 0631	Yes		Yes	
•Shipbuilding approval	Yes		Yes	
•UL approval	Yes		Yes	
Dimensions and weight				
•Installation	on 35 mm DIN rail, 2 modules wide		on 35 mm DIN rail, 2 modules wide	
•Width	36 mm		36 mm	
•Height	90 mm		90 mm	
•Depth	55 mm		55 mm	

Ordering Data	Order No.	Order No.
LOGO! DM8 24 24 V DC supply voltage, 4 digital inputs 24 V DC, 4 digital outputs 24 V DC, 0.3 A	6ED1 055-1CB00-0BA0	
LOGO! DM8 12/24R 12/24 V DC supply voltage, 4 digital inputs 12/24 V DC, 4 relay outputs 5 A	6ED1 055-1MB00-0BA1	
LOGO! DM8 24R 24 V AC/DC supply voltage, 4 digital inputs 24 V AC/DC, 4 relay outputs 5 A	6ED1 055-1HB00-0BA0	
LOGO! DM8 230R 115/230 V AC/DC supply voltage, 4 digital inputs 115/230 V AC/DC, 4 relay outputs 5 A	6ED1 055-1FB00-0BA1	
LOGO! DM16 24 24 V DC supply voltage, 8 digital inputs 24 V DC, 8 digital outputs 24 V DC, 0.3 A	6ED1 055-1CB10-0BA0	
LOGO! DM16 24R 24 V DC supply voltage, 8 digital inputs 24 V DC, 8 relay outputs 5 A	6ED1 055-1NB10-0BA0	
LOGO! DM16 230R 115/230 V AC/DC supply voltage, 8 digital inputs 115/230 V AC/DC, 8 relay outputs 5 A	6ED1 055-1FB10-0BA1	
LOGO! AM2 12/24 V DC supply voltage, 2 analog inputs 0 to 10 V or 0 to 20 mA, 10-bit resolution	6ED1 055-1MA00-0BA0	
LOGO! AM2 PT 100 12/24 V DC supply voltage, 2 Pt100 analog inputs, tempera- ture range -50 °C to 200 °C	6ED1 055-1MD00-0BA0	
		Accessories
		LOGO! Manual
		German 6ED1 050-1AA00-0AE5
		English 6ED1 050-1AA00-0BE5
		French 6ED1 050-1AA00-0CE5
		Spanish 6ED1 050-1AA00-0DE5
		Italian 6ED1 050-1AA00-0EE5
		LOGO! Memory Card 6ED1 056-5CA00-0BA0
		For copying, with know-how pro- tection
		LOGO!Soft Comfort V4.0 ^{B)} 6ED1 058-0BA00-0YA0
		For programming on the PC in LAD/FDP; executable on Windows 95 and higher, Linux, MAC OSX; on CD-ROM
		LOGO!Soft Comfort Upgrade ^{B)} 6ED1 058-0CA00-0YE0
		from V1.0 to V4.0
		LOGO! PC cable 6ED1 057-1AA00-0BA0
		For transferring programs bet- ween LOGO! and the PC
		LOGO! News Box, 12/24 V
		Contains LOGO! 12/24RC, LOGO! PC cable, LOGO!Soft Comfort, Tips&Tricks manual, screwdriver, information material
		German ^{C)} 6ED1 057-3BA00-0AA3
		English ^{C)} 6ED1 057-3BA00-0BA3
		LOGO! News Box, 230 V
		Contains LOGO! 230RC, LOGO! PC cable, LOGO!Soft Comfort, Tips&Tricks manual, screwdriver, information material
		German ^{C)} 6ED1 057-3AA00-0AA8
		English ^{C)} 6ED1 057-3AA00-0BA8

B) Subject to export regulations: AL: N and ECCN: EAR99S

C) Subject to export regulations: AL: N and ECCN: EAR99T

LOGO! logic module

LOGO! modular

2

LOGO! CM EIB/KNX communication module

Overview



- Expansion module for LOGO! basic versions
- For communication between the LOGO! master and external *EIB* components through *EIB*

Technical specifications

CM EIB/KNX	
Supply voltage	24 V AC/DC
Inputs, max.	16 DE/12 DA/8 AE/2 AA
Outputs, max.	16 digital
Continuous current	25 mA
Short-circuit protection	External fuse protection is required
Integrated time switches/power reserve	–
Ambient temperature	0 to +55 °C
RI specification	To EN 55 011 (limit class B)
Degree of protection	IP20
Certification	to VDE 0631, IEC61131-2, cULus, FM
Mounting	On DIN rail 35 mm, 2 module widths wide
Dimensions (W x H x D) in mm	36 (2 TE) x 90 x 55

Ordering Data

Order No.

LOGO!^{A)} CM EIB KNX communications module

6BK1 700-0BA00-0AA1

For connecting to *EIB*, 24 V DC supply voltage

Accessories

LOGO! Manual

German
English
French
Spanish
Italian

6ED1 050-1AA00-0AE5
6ED1 050-1AA00-0BE5
6ED1 050-1AA00-0CE5
6ED1 050-1AA00-0DE5
6ED1 050-1AA00-0EE5

A) Subject to export regulations: AL: N and ECCN: EAR99H

Overview

Each LOGO! can now be connected to the AS-Interface system



An intelligent slave can be integrated into the AS-Interface system with the AS-Interface for LOGO!. The modular interface allows the different basic units to be integrated into the system depending on the required functionality. In addition, the functionality can be quickly and simply adapted to changed requirements by replacing the basic unit.

The interface provides four inputs and four outputs for the system. These I/Os, however, are not implemented in hardware, but are only virtually available via the interface.

Technical specifications

Supply voltage in V	24 V DC	
Inputs/outputs	4 / 4 (virtual inputs/outputs)	
Bus connection	AS-Interface according to specification	
Ambient temperature in °C	0 ... +55	
Degree of protection	IP20	
Mounting	onto standard mounting rail	
Dimensions (W x H x D) in mm	36 x 90 x 58	
LED displays	<i>LED</i>	<i>Status</i>
	Green	OK
	Red	No data traffic
	Flashes red/yellow	Zero address

Ordering Data

Order No.

AS-Interface connection for LOGO!

3RK1 400-0CE10-0AA2

LOGO! logic module

LOGO!Power

2

LOGO!Power, LOGO!Power 12 V

Application



LOGO!Power supplies are primary switched-mode power supplies that are optimized to the LOGO! logic modules in terms of functionality and design.

In accordance with the required performance, the LOGO!Power supplies are available in two sizes, whereby the new generation is now even more compact despite the extended functionality. The width of the smaller type is only 54 mm now instead of the previous 72 mm and the larger type has been reduced in size from 126 mm to 72 mm. An extremely compact 4 A type with only 90 mm width completes the LOGO!Power family. An LED indicates whether the output voltage level is correct and, in the event

of an overload or short-circuit, the primary switched-mode regulator delivers a constant current, i.e. without restart attempts.

LOGO!Power naturally supplies the small LOGO! control modules. They can, however, also be used elsewhere. Apart from their function as system power supplies, LOGO!Power is also suitable for supplying other consumers in the low-end performance range. With the wide input range of 85 V to 264 V AC and radio interference level B, they can be used universally in a diverse range of applications in the low-end performance range. Because the advantages of the primary switched-mode regulator convince customers right down the line.

For example:

- Enhanced protection of connected loads thanks to the regulated output voltage
- Low power loss in the control cabinet thanks to the high efficiency
- Compact design and low weight.

And LOGO!Power is predestined for equipment combinations in standard N distribution boards thanks to

- Mounting on a 35 mm standard rail
- Low mounting depth and stepped cross-section.

Of course, the power supplies comply with the relevant European and American regulations.

Technical specifications LOGO!Power 12 V

Type	12 V/1.9 A	12 V /4.5 A
Order No.	6EP1 321-1SH02	6EP1 322-1SH02
Input	Single-phase AC	Single-phase AC
Rated voltage $V_{in \text{ rated}}$	100-240 V AC wide-range input	100-240 V AC wide-range input
Voltage range	85 V to 264 V AC	85 V to 264 V AC
Overvoltage protection	$2.3 \times V_{in \text{ rated}}/1.3 \text{ ms}$	$2.3 \times V_{in \text{ rated}}/1.3 \text{ ms}$
Mains buffering at $I_{out \text{ rated}}$	> 40 ms at $V_{in} = 187 \text{ V}$	> 40 ms at $V_{in} = 187 \text{ V}$
Rated mains frequency, range	50/60 Hz; 47 to 63 Hz	50/60 Hz; 47 to 63 Hz
Rated current $I_{in \text{ rated}}$	0.53 - 0.3 A	1.13 - 0.43 A
Inrush current limitation (+25°C)	< 15 A	< 30 A
I^2t	< 0.8 A ² s	< 3 A ² s
Integrated line-side fuse	Internal	Internal
Recommended circuit-breaker (IEC 898) in mains supply line	From 16 A Characteristic B or from 10 A Characteristic C	From 16 A Characteristic B or from 10 A Characteristic C
Output	Stabilized, floating direct voltage	Stabilized, floating direct voltage
Rated voltage $V_{out \text{ rated}}$	12 V DC	12 V DC
Total tolerance, static	± 3 %	± 3 %
•Static mains compensation	Approx. 0.2 %	Approx. 0.1 %
•Static load stabilization	Approx. 1.5 %	Approx. 1.5 %
Residual ripple (frequency approx. 90 kHz)	< 200 mV _{pp}	< 200 mV _{pp}
Spikes (bandwidth approx. 20 MHz)	< 300 mV _{pp}	< 300 mV _{pp}
Setting range	10.5 to 16.1 V	10.5 to 16.1 V

Technical specifications LOGO!Power 12 V (Continued)

Type	12 V/1.9 A	12 V/4.5 A
Order No.	6EP1 321-1SH02	6EP1 322-1SH02
Status display	Green LED for output voltage OK	Green LED for output voltage OK
Power ON/OFF behavior	No overshoot of V _{out} (soft start)	No overshoot of V _{out} (soft start)
Starting delay/voltage rise	< 0.5 s/typ. 15 ms	< 0.5 s/typ. 10 ms
Rated current I _{outrated}	1.9 A	4.5 A
Current range up to +55 °C	0 to 1.9 A	0 to 4.5 A
Parallel connection for increased output	Yes	Yes
Efficiency		
Efficiency at V _{outrated} , I _{out rated}	typ. 80 %	typ. 85 %
Power loss at V _{outrated} , I _{out rated}	typ. 5 W	typ. 10 W
Control		
Dyn. mains compensation (V _{out rated} ± 15%)	< 0.2 % V _{out}	< 0.2 % V _{out}
Dyn. load compensation (I _{out} :10/90/10 %)	± 3 % V _{out}	± 4.2 % V _{out}
Settling time		
•Load step from 10 to 90%	typ. 20 ms	typ. 20 ms
•Load step from 90 to 10%	typ. 20 ms	typ. 20 ms
Protection and monitoring		
Current limitation	typ. 2.5 A	typ. 5.9 A
Short-circuit protection	Constant current characteristic	Constant current characteristic
Continuous rms short-circuit current	< 4 A	< 8 A
Overload/short-circuit indicator	-	-
Safety		
Galvanic isolation primary/secondary	Yes, SELV output voltage V _{out} acc. to EN 60950 and EN 50178	Yes, SELV output voltage V _{out} acc. to EN 60950 and EN 50178
Protective class	Class II (without PE conductor)	Class II (without PE conductor)
CE-marking	Yes	Yes
UL/cUL (CSA), approval	Yes, cULus listed (UL 508, CSA 22.2 No. 14-M95), File E197259; cURus recognized (UL 60950, CSA22.2 No. 60950), File E151273	Yes, cULus listed (UL 508, CSA 22.2 No. 14-M95), File E197259; cURus recognized (UL 60950, CSA22.2 No. 60950), File E151273
FM approval	Yes, Class I Div. 2, Group A, B, C, D T4	Yes, Class I Div. 2, Group A, B, C, D T4
Appr. for use in marine vessels	Yes, GL, ABS	Yes, GL, ABS
Degree of protection (EN 60 529)	IP20	IP20
EMC		
Interference emission	EN 55022 Class B	EN 55022 Class B
Line harmonics limitation	Not applicable	Not applicable
Interference immunity	EN 61000-6-2	EN 61000-6-2
Operational data		
Ambient temperature range	-20 to +55 °C with natural convection	-20 to +55 °C with natural convection
Transportation and storage temperature range	-40 to +70 °C	-40 to +70 °C
Humidity class	Climatic class 3K3 acc. to EN 60721, no condensation	Climatic class 3K3 acc. to EN 60721, no condensation
Mechanical specifications		
Connections		
•Mains input L1, N	One screw-type terminal each for 0.5 to 2.5 mm ² single-core/finely stranded	One screw-type terminal each for 0.5 to 2.5 mm ² single-core/finely stranded
•Output + •Output	2 screw-type terminals each for 0.5 to 2.5 mm ²	2 screw-type terminals each for 0.5 to 2.5 mm ²
Dimensions (W x H x D) in mm	54 x 90 x 55	72 x 90 x 55
Weight	Approx. 0.17 kg	Approx. 0.25 kg
Mounting	Snap-mounting on DIN rail EN 50022-35x15/7.5	Snap-mounting on DIN rail EN 50022-35x15/7.5

Technical specifications LOGO!Power 24 V

Type	24 V/1.3 A	24 V/2.5 A	24 V/4 A
Order No.	6EP1 331-1SH02	6EP1 332-1SH42	6EP1 332-1SH51
Input	Single-phase AC	Single-phase AC	Single-phase AC
Rated voltage $V_{in rated}$	100 to 240 V AC wide-range input	100 to 240 V AC wide-range input	100 to 240 V AC wide-range input
Voltage range	85 to 264 V AC	85 to 264 V AC	85 to 264 V AC
Overvoltage strength	$2.3 \times V_{in rated}/1.3 \text{ ms}$	$2.3 \times V_{in rated}/1.3 \text{ ms}$	$2.3 \times V_{in rated}/1.3 \text{ ms}$
Mains buffering at $I_{out rated}$	> 40 ms at $V_{in} = 187 \text{ V}$	> 40 ms at $V_{in} = 187 \text{ V}$	> 40 ms at $V_{in} = 187 \text{ V}$
Mains frequency nominal value and range	50/60 Hz; 47 to 63 Hz	50/60 Hz; 47 to 63 Hz	50/60 Hz; 47 to 63 Hz
Rated current $I_{in rated}$	0.7 - 0.35 A	1.22 - 0.66 A	1.95 - 0.97 A
Inrush current limiting (+25 °C)	< 15 A	< 30 A	< 30 A
I^2t	< 0.8 A ² s	< 3 A ² s	< 2.5 A ² s
Built-in input fuse	Internal	Internal	Internal
Recommended circuit-breaker (IEC 898) in mains supply line	From 16 A Characteristic B or from 10 A Characteristic C	From 16 A Characteristic B or from 10 A Characteristic C	From 16 A Characteristic B or from 10 A Characteristic C
Output	Stabilized, floating direct voltage	Stabilized, floating direct voltage	Stabilized, floating direct voltage
Rated voltage $V_{out rated}$	24 V DC	24 V DC	24 V DC
Total tolerance, static	± 3 %	± 3 %	± 3 %
•Static mains stabilization	Approx. 0.1 %	Approx. 0.1 %	Approx. 0.1 %
•Static load stabilization	Approx. 1.5 %	Approx. 1.5 %	Approx. 1.5 %
Residual ripple (frequency approx. 90 kHz)	< 200 mV _{pp}	< 200 mV _{pp}	< 200 mV _{pp}
Spikes (bandwidth approx. 20 MHz)	< 300 mV _{pp}	< 300 mV _{pp}	< 300 mV _{pp}
Setting range	22.2 to 26.4 V	22.2 to 26.4 V	22.2 to 26.4 V
Status display	Green LED for output voltage OK	Green LED for output voltage OK	Green LED for output voltage OK
Switch-On/Switch-Off response	No overshoot of V_{out} (soft start)	No overshoot of V_{out} (soft start)	No overshoot of V_{out} (soft start)
Starting delay/voltage rise	< 0.5 s/typ. 15 ms	< 0.5 s/typ. 10 ms	< 0.5 s/typ. 35 ms
Rated current $I_{out rated}$	1.3 A	2.5 A	4 A
Current range up to +55 °C	0 to 1.3 A	0 to 2.5 A	0 to 4 A
Parallel connection for increased output	Yes	Yes	Yes
Efficiency			
Efficiency at $V_{out rated}$, $I_{out rated}$	typ. 82 %	typ. 87 %	typ. 89 %
Power loss at $V_{out rated}$, $I_{out rated}$	typ. 7 W	typ. 9 W	typ. 12 W
Control			
Dyn. mains compensation ($V_{in rated} \pm 15 \%$)	< 0.2 % V_{out}	< 0.2 % V_{out}	< 0.2 % V_{out}
Dyn. load compensation (I_{out} : 10/90/10 %)	± 1.5 % V_{out}	± 1.5 % V_{out}	± 1.5 % V_{out}
Settling time			
•Load step from 10 to 90%	typ. 20 ms	typ. 20 ms	typ. 20 ms
•Load step from 90 to 10%	typ. 20 ms	typ. 20 ms	typ. 20 ms
Protection and monitoring			
Current limiting	typ. 2 A	typ. 3.4 A	typ. 4.7 A
Short-circuit protection	Constant current characteristic	Constant current characteristic	Constant current characteristic
Continuous short-circuit rms current	< 4 A	< 8 A	< 10 A
Overload/short-circuit indicator	-	-	-

Technical specifications LOGO!Power 24 V (Continued)

Type	24 V/1.3 A	24 V /2.5 A	24 V /4 A
Safety			
Galvanic isolation, primary/secondary	Yes, SELV output voltage V_{out} acc. to EN 60950 and EN 50178	Yes, SELV output voltage V_{out} acc. to EN 60950 and EN 50178	Yes, SELV output voltage V_{out} acc. to EN 60950 and EN 50178
Protective class	Class II (without PE conductor)	Class II (without PE conductor)	Class II (without PE conductor)
CE-marking	Yes	Yes	Yes
UL/cUL (CSA), approval	Yes, cULus listed (UL 508, CSA 22.2), File E197259; cURus recognized (UL 60950, CSA22.2), File E151273	Yes, cULus listed (UL 508, CSA 22.2), File E197259; cURus recognized (UL 60950, CSA22.2), File E151273	Yes, cULus listed (UL 508, CSA 22.2), File E197259; cURus recognized (UL 60950, CSA22.2), File E151273
FM approval	Yes, Class I Div. 2, Group A, B, C, D T4	Yes, Class I Div. 2, Group A, B, C, D T4	Available soon
Appr. for use in marine vessels	Yes, GL, ABS	Yes, GL, ABS	Yes, GL, ABS
Degree of protection (EN 60 529)	IP20	IP20	IP20
EMC			
Interference emission	EN 55022 Class B	EN 55022 Class B	EN 55022 Class B
Mains harmonics limitation	Not applicable	Not applicable	EN 61000-3-2
Interference immunity	EN 61000-6-2	EN 61000-6-2	EN 61000-6-2
Operational data			
Ambient temperature range	-20 to +55°C with natural convection	-20 to +55°C with natural convection	-20 to +55°C with natural convection
Transport and storage temperature range	-40 to +70 °C	-40 to +70 °C	-40 to +70 °C
Humidity class	Climatic class 3K3 acc. to EN 60721, no condensation	Climatic class 3K3 acc. to EN 60721, no condensation	Climatic class 3K3 acc. to EN 60721, no condensation
Mechanical specifications			
Mains input connections L1, N	One screw-type terminal each for 0.5 to 2.5 mm ² single-core/finely stranded	One screw-type terminal each for 0.5 to 2.5 mm ² single-core/finely stranded	One screw-type terminal each for 0.5 to 2.5 mm ² single-core/finely stranded
Connections			
•Output +	2 screw-type terminals each for 0.5 to 2.5 mm ²	2 screw-type terminals each for 0.5 to 2.5 mm ²	2 screw-type terminals each for 0.5 to 2.5 mm ²
•Output			
Dimensions (W x H x D) in mm	54 x 90 x 55	72 x 90 x 55	90 x 90 x 55
Weight	Approx. 0.17 kg	Approx. 0.25 kg	Approx. 0.34 kg
Mounting	Snap-mounting on DIN rail EN 50022-35x15/7.5	Snap-mounting on DIN rail EN 50022-35x15/7.5	Snap-mounting on DIN rail EN 50022-35x15/7.5

Ordering Data

Order No.

LOGO!Power 12 V 1.9 A Input 100-240 V AC Output 12 V DC, 1.9 A	6EP1 321-1SH02
LOGO!Power 12 V 4.5 A Input 100-240 V AC Output 12 V DC, 4.5 A	6EP1 322-1SH02
LOGO!Power 24 V 1.3 A Input 100-240 V AC Output 24 V DC, 1.3 A	6EP1 331-1SH02
LOGO!Power 24 V 2.5 A Input 100-240 V AC Output 24 V DC, 2.5 A	6EP1 332-1SH42
LOGO!Power 24 V 4 A^{A)} Input 100-240 V AC Output 24 V DC, 4 A	6EP1 332-1SH51

A) Subject to export regulations: AL: N and ECCN: EAR99H

LOGO! logic module

LOGO!Contact

2

LOGO!Contact

Overview



- Switching module for the direct switching of resistive loads and motors

Technical specifications

	6ED1 057-4CA00-0AA0	6ED1 057-4EA00-0AA0
Dimensions and weight		
•Weight, approx.	160 g	160 g

Ordering Data

LOGO!Contact
 Module for direct switching of resistive consumers up to 20 A and motors up to 4 kW
 Switching voltage 24 V
 Switching voltage 230 V

Order No.

6ED1 057-4CA00-0AA0
6ED1 057-4EA00-0AA0

Overview



- The user-friendly software for creating control programs on a PC
- Creation of control programs in Control System Flowchart (CSF) or Ladder Diagram (LAD)
- Plus testing, simulation, online testing and archiving of control programs
- Professional documentation via numerous comment and print functions

Minimum system requirements

Windows 95/98, NT 4.0, ME, 2000 or XP

- Pentium PC
- 90 MB free disk space
- 64 MB RAM
- SVGA graphics card with minimum resolution 800x600 (256 colors)

Mac OS X

- PowerMac G3, G4, G4 Cube, iMac, PowerBook G3, G4 or iBook

Linux (tested using Caldera OpenLinux 2.4)

- Will function on all Linux distributions on which Java 2 SDK version 1.3.1 is running
- Please refer to your respective Linux distribution for the hardware requirements.

Ordering Data

Order No.

LOGO!Soft Comfort V4.0^{B)}

6ED1 058-0BA00-0YA0

For programming on the PC in LAD/SFC; executes on Windows 95 and higher, Linux, MAC OS X; on CD-ROM

LOGO!Soft Comfort Upgrade^{B)}

6ED1 058-0CA00-0YE0

V1.0 upwards to V4.0

B) Subject to export regulations: AL: N and ECCN: EAR99S

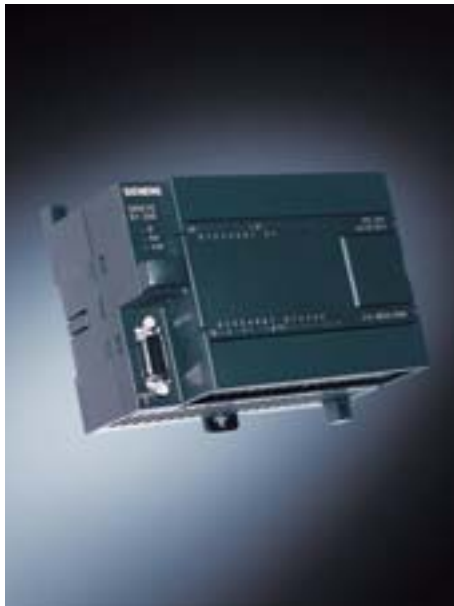

3/2	Introduction
3/4	Central processing units CPU 221, 222, 224, 224 XP, 226
3/22	SIPLUS central processing units SIPLUS central processing units
3/23	Digital modules Digital modules
3/30	SIPLUS digital modules SIPLUS digital modules
3/31	Analog modules Analog modules
3/34	EM 231 thermocouple module
3/36	EM 231 RTD module
3/38	SIPLUS analog modules SIPLUS analog modules
3/39	Function modules EM 253 positioning module
3/41	Communication EM 241 modem
3/42	EM 277 PROFIBUS DP module
3/43	CP 243-2
3/44	CP 243-1
3/45	CP 243-1 IT
3/46	Power supplies Power supplies
3/48	Human Machine Interface TD 200 text display
3/49	TD 200C text display
3/50	SIMATIC TP 177micro
3/53	SIMATIC OP 73micro
3/55	Software Software



Overview



SIMATIC S7-200

- The micro PLC offers maximum automation at minimum cost
- Extremely simple installation, programming and operation
- Large-scale integration, space-saving, powerful
- Can be used both for simple controls and for complex automation tasks
- All CPUs can be used in stand alone mode, in networks and within distributed structures
- Suitable for applications where programmable controllers would not have been viable in the past
- With outstanding real-time performance and powerful communication options (PPI, PROFIBUS DP, AS-Interface)
- Shipbuilding certification from
 - American Bureau of Shipping (ABS)
 - Bureau Veritas (BV)
 - Det Norske Veritas (DNV)
 - Germanischer Lloyd (GL)
 - Lloyds Register of Shipping (LRS)
 - Registro Italiano Navale (RINA)
 - Nippon Kaiji Kyokai (NK)

SIPLUS S7-200

- The PLC for use in the harshest environmental conditions
- With extended temperature range from -25 to +70°C
- Suitable for extraordinary medial load (pollution gas atmosphere)
- Occasional short-term condensation and increased mechanical loading permissible
- With the proven PLC technology of the S7-200
- Convenient handling, programming, maintenance and service
- Ideal for use in the automotive industry, environmental technology, mining, chemical plants, production technology, food industry etc.
- The alternative to expensive custom solutions

More Information you can find at:

<http://www.siemens.com/siplus>

Technical specifications

General Technical specifications SIMATIC S7-200

Degree of protection	IP20 in accordance with IEC 529
Ambient temperature	
<ul style="list-style-type: none"> • Operation (95% relative humidity) <ul style="list-style-type: none"> - With horizontal mounting 0 to 55°C - With vertical mounting 0 to 45 °C • Transport and storage General <ul style="list-style-type: none"> - with 95% relative humidity 25 to 55 °C 	
Isolation	
<ul style="list-style-type: none"> • 5/24 V DC circuits Test voltage 500 V AC • 115/230 V AC circuits to ground Test voltage 1500 V AC • 115/230 V AC circuits to 115/230 V AC circuits Test voltage 1500 V AC • 230 V AC circuits to 5/24 V DC circuits Test voltage 1500 V AC • 115 V AC circuits to 5/24 V DC circuits Test voltage 1500 V AC 	
Electromagnetic compatibility	Requirements of EMC law
<ul style="list-style-type: none"> • Noise immunity to EN 50082-2 • Emitted interference according to EN 50081-1 and EN 50081-2 	<p>Tested according to: IEC 801-2, IEC 801-3, IEC 801-4, EN 50141, EN 50204, IEC 801-5, VDE 0160</p> <p>Tested according to EN 55011, Class A, Group 1 and EN 55011, Class B, Group 1</p>
Mechanical rating	
<ul style="list-style-type: none"> • Vibrations, tested according to/tested with • Shock, tested according to/tested with 	<p>IEC 68, Part 2-6: 10 to 57 Hz; constant amplitude 0.3 mm; 58 to 150 Hz; constant acceleration 1 g (mounted on DIN rail) or 2 g (mounted in control cabinet); type of vibration: frequency cycles with a rate of change of 1 octave/minute; vibration duration: 10 frequency cycles per axis in each direction of the 3 mutually perpendicular axes</p> <p>IEC 68, Part 2-27/half-sine: shock strength 15 g (peak value), duration 11 ms, 6 shocks on each of the 3 mutually perpendicular axes</p>

General Technical specifications SIPLUS S7-200

Ambient temperature	
Temperature	Horizontal mounting: -25 °C to 70 °C Vertical mounting: -25 °C to 50 °C
Relative humidity	5 to 95%; transient condensation permissible, corresponding to relative humidity (RH-) stress grade 2 according to IEC 1131-2 and IEC 721 3-3 Cl. 3K5
Transient icing	-25 °C to 0 °C IEC 721 3-3 Cl. 3K5
Atmospheric pressure	1080 to 795 hPa corresponding to a height of -1000 to 2000 m
Pollutant concentration	SO ₂ : < 0,5 ppm; relative humidity <60% Test: 10 ppm, 4 days H ₂ S: < 0,1 ppm; relative humidity <60% Test: 1 ppm, 4 days (according to IEC 721 3-3; Class 3C3)
Mechanical environmental conditions	
Vibrations	Type of vibration: frequency progressions changing at 1 octave per minute. 2 Hz ≤ f ≤ 9 Hz, constant amplitude 3,0 mm 9 Hz ≤ f ≤ 150 Hz, constant acceleration 1 g; Duration of vibration: 10 frequency progressions per axis in each direction of the three mutually perpendicular axes; Vibration testing according to IEC 68 section 2-6 (Sinus) and IEC 721 3-3, Class 3M4
Shock	Type of shock: semisinusoidal shock strength: 15 g peak value, duration shock direction 11 ms: 3 shocks each in +/- direction on each of the mutually perpendicular axes Shock testing according to IEC 68 section 2-27
Conformity	EN 50155 (railroad applications - electronic device on rail vehicles)

SIMATIC S7-200

Central processing units

CPU 221, 222, 224, 224 XP, 226

Overview

3



- The smart compact solution
- With 10 inputs/outputs on board
- Not expandable



- The compact high-performance CPU
- With 24 inputs/outputs on board
- Expandable with up to 7 expansion modules



- The superior compact solution
- With 14 inputs/outputs on board
- Expandable with up to 2 expansion modules



- The power CPU
- With 24 digital and 3 analog inputs/outputs onboard
- Expandable with up to 7 expansion modules

Overview



- The high-performance package for complex technical tasks
- With additional PPI port for added flexibility and communication options
- With 40 inputs/outputs on board
- Expansion capability for max. 7 expansion racks

Technical specifications

	6ES7 211-0AA23-0XB0	6ES7 211-0BA23-0XB0	6ES7 212-1AB23-0XB0	6ES7 212-1BB23-0XB0
Supply voltages				
Rated value				
- 24 V DC	Yes		Yes	
- permissible range, lower limit (DC)	20.4 V		20.4 V	
- permissible range, upper limit (DC)	28.8 V		28.8 V	
- 120 V AC		Yes		Yes
- 230 V AC		Yes		Yes
- permissible range, lower limit (AC)		85 V		85 V
- permissible range, upper limit (AC)		264 V		264 V
- permissible frequency range, lower limit		47 Hz		47 Hz
- permissible frequency range, upper limit		63 Hz		63 Hz
Voltages and currents				
Load voltage L+				
- Rated value (DC)	24 V	24 V	24 V	24 V
- permissible range, lower limit (DC)	20.4 V	5 V	20.4 V	5 V
- permissible range, upper limit (DC)	28.8 V	30 V	28.8 V	30 V
Load voltage L1				
- Rated value (AC)		100 V; 100 to 230 V AC		100 V; 100 to 230 V AC
- permissible range, lower limit (AC)		5 V		5 V
- permissible range, upper limit (AC)		250 V		250 V
- permissible frequency range, lower limit		47 Hz		47 Hz
- permissible frequency range, upper limit		63 Hz		63 Hz
Current consumption				
• Inrush current, max.	10 A; at 28.8 V	20 A; at 264 V	10 A; at 28.8 V	20 A; at 264 V
• from supply voltage L+, max.	450 mA; 80 to 450 mA		500 mA; 85 to 500 mA, output current for expansion modules (5 V DC) 340 mA	
• from supply voltage L1, max.		120 mA; 15 to 60 mA (240 V), 30 to 120 mA (120 V); output current for expansion modules (5 V DC) 340 mA		140 mA; 20 to 70 mA (240 V), 40 to 140 mA (120 V); output current for expansion modules (5 V DC) 340 mA

SIMATIC S7-200

Central processing units

CPU 221, 222, 224, 224 XP, 226

3

Technical specifications (continued)

	6ES7 211-0AA23-0XB0	6ES7 211-0BA23-0XB0	6ES7 212-1AB23-0XB0	6ES7 212-1BB23-0XB0
back-up battery - Backup time	50 h; (min. 8 h at 40 °C); 200 days (typ.) with optional battery module	50 h; (min. 8 h at 40 °C); 200 days (typ.) with optional battery module	50 h; (min. 8 h at 40 °C); 200 days (typ.) with optional battery module	50 h; (min. 8 h at 40 °C); 200 days (typ.) with optional battery module
Memory/backup				
Memory - Number of memory modules (optional)	1; pluggable memory module, content identical to integral EEPROM, in addition, recipes, data logs and other files can be saved.	1; pluggable memory module, content identical to integral EEPROM, in addition, recipes, data logs and other files can be saved.	1; pluggable memory module, content identical to integral EEPROM, in addition, recipes, data logs and other files can be saved.	1; pluggable memory module, content identical to integral EEPROM, in addition, recipes, data logs and other files can be saved.
•Data memory and program memory - Data memory, max. - Program memory, max.	2 KByte 4 KByte	2 KByte 4 KByte	2 KByte 4 KByte	2 KByte 4 KByte
Backup - available	Yes; Program: entire program maintenance- free in integral EEPROM, programmable via CPU; data: entire DB 1 loaded from PG/PC maintenance-free in integral EEPROM, current values of DB 1 in RAM, retentive flags, timers, counters etc., maintenance free via super capacitor; optional battery	Yes; Program: entire program maintenance- free in integral EEPROM, programmable via CPU; data: entire DB 1 loaded from PG/PC maintenance-free in integral EEPROM, current values of DB 1 in RAM, retentive flags, timers, counters etc., maintenance free via super capacitor; optional battery	Yes; Program: entire program maintenance- free in integral EEPROM, programmable via CPU; data: entire DB 1 loaded from PG/PC maintenance-free in integral EEPROM, current values of DB 1 in RAM, retentive flags, timers, counters etc., maintenance free via super capacitor; optional battery	Yes; Program: entire program maintenance- free in integral EEPROM, programmable via CPU; data: entire DB 1 loaded from PG/PC maintenance-free in integral EEPROM, current values of DB 1 in RAM, retentive flags, timers, counters etc., maintenance free via super capacitor; optional battery
CPU/processing times •for bit instruction, max.	0,22 µs	0,22 µs	0,22 µs	0,22 µs
Timers/counters and their reten- tive characteristics				
S7 counter - Number	256	256	256	256
•of which retentive with battery - adjustable	Yes; via super capacitor or battery	Yes; via super capacitor or battery	Yes; via super capacitor or battery	Yes; via super capacitor or battery
- lower limit	1	1	1	1
- upper limit	256	256	256	256
•Counting range - lower limit	0	0	0	0
- upper limit	32.767	32.767	32.767	32.767
S7 times - Number	256	256	256	256
•of which retentive with battery - adjustable	Yes; via super capacitor or battery	Yes; via super capacitor or battery	Yes; via super capacitor or battery	Yes; via super capacitor or battery
- upper limit	64	64	64	64
•Timing range - lower limit	1 ms	1 ms	1 ms	1 ms
- upper limit	54 min; 4 times, 1 ms to 30 s 16 times, 10 ms to 5 min 236 times, 100 ms to 54 min	54 min; 4 times, 1 ms to 30 s 16 times, 10 ms to 5 min 236 times, 100 ms to 54 min	54 min; 4 times, 1 ms to 30 s 16 times, 10 ms to 5 min 236 times, 100 ms to 54 min	54 min; 4 times, 1 ms to 30 s 16 times, 10 ms to 5 min 236 times, 100 ms to 54 min

Technical specifications (continued)

	6ES7 211-0AA23-0XB0	6ES7 211-0BA23-0XB0	6ES7 212-1AB23-0XB0	6ES7 212-1BB23-0XB0
Data areas and their retentive characteristics				
Flags				
- Number	32 Byte	32 Byte	32 Byte	32 Byte
- adjustable retentivity	Yes; M0.0 to M31.7	Yes; M0.0 to M31.7	Yes; M0.0 to M31.7	Yes; M0.0 to M31.7
- of which retentive with battery	0 to 255, via super capacitor or battery, adjustable	0 to 255, via super capacitor or battery, adjustable	0 to 255, via super capacitor or battery, adjustable	0 to 255, via super capacitor or battery, adjustable
- of which retentive without battery	0 to 112 in EEPROM, adjustable	0 to 112 in EEPROM, adjustable	0 to 112 in EEPROM, adjustable	0 to 112 in EEPROM, adjustable
Configuration				
•Connectable programming devices/PCs	SIMATIC PG/PC, Standard PC	SIMATIC PG/PC, Standard PC	SIMATIC PG/PC, Standard PC	SIMATIC PG/PC, S tandard PC
•Central units/expansion units, max.			2 expansion modules. Only expansion modules of the S7-22x series can be used. Because of the limited output current, the use of expansion modules may be subject to restrictions.	2 expansion modules. Only expansion modules of the S7-22x series can be used (because of the limited output current, the use of expansion modules may be subject to restrictions.)
I/O expansions				
- Analog inputs/outputs, max.			10; max. 8 inputs and 2 outputs (EM) or max. 0 inputs and 4 outputs (EM)	10; max. 8 inputs and 2 outputs (EM) or max. 0 inputs and 4 outputs (EM)
- Digital inputs/outputs, max.			78; max. 40 inputs and 38 outputs (CPU+EM)	78; max. 40 inputs and 38 outputs (CPU+EM)
- AS interface inputs/outputs, max.			31; AS interface slaves (CP 243-2)	31; AS interface slaves (CP 243-2)
Connection system				
•Pluggable I/O terminals	No	No	No	No
1st interface				
•Type of interface	integrated RS 485 interface	integrated RS 485 interface	integrated RS 485 interface	integrated RS 485 interface
•Physical	RS 485	RS 485	RS 485	RS 485
Functionality				
- MPI	Yes; as MPI Slave for data exchange with MPI Masters (S7-300/S7-400-CPU, OPs, TDs, Push Button Panels); internal S7-200 CPU/CPU communication is limited in the MPI network; transmission rates 19.2/187.5 kbit/s	Yes; as MPI Slave for data exchange with MPI Masters (S7-300/S7-400-CPU, OPs, TDs, Push Button Panels); internal S7-200 CPU/CPU communication is limited in the MPI network; transmission rates 19.2/187.5 kbit/s	Yes; as MPI Slave for data exchange with MPI Masters (S7-300/S7-400-CPU, OPs, TDs, Push Button Panels); internal S7-200 CPU/CPU communication is limited in the MPI network; transmission rates 19.2/187.5 kbit/s	Yes; as MPI Slave for data exchange with MPI Masters (S7-300/S7-400-CPU, OPs, TDs, Push Button Panels); internal S7-200 CPU/CPU communication is limited in the MPI network; transmission rates 19.2/187.5 kbit/s
- PPI	Yes; with PPI protocol for programming functions, HMI functions (TD 200, OP), S7-200 internal CPU/CPU communication; transmission rates 9.6/19.2/187.5 kbit/s	Yes; with PPI protocol for programming functions, HMI functions (TD 200, OP), S7-200 internal CPU/CPU communication; transmission rates 9.6/19.2/187.5 kbit/s	Yes; with PPI protocol for programming functions, HMI functions (TD 200, OP), S7-200 internal CPU/CPU communication; transmission rates 9.6/19.2/187.5 kbit/s	Yes; with PPI protocol for programming functions, HMI functions (TD 200, OP), S7-200 internal CPU/CPU communication; transmission rates 9.6/19.2/187.5 kbit/s
- Serial data transmission	Yes; as a freely programmable interface with an interrupt option for serial data transmission with external units with ASCII protocol baud rates: 0.3/0.6/1.2/2.4/4.8/9.6/19.2/38.4 kbit/s; at 1.2 to 38.4 kbit/s, the PC/PPI cable can be used as an RS232/RS485 converter	Yes; as a freely programmable interface with an interrupt option for serial data transmission with external units with ASCII protocol baud rates: 0.3/0.6/1.2/2.4/4.8/9.6/19.2/38.4 kbit/s; at 1.2 to 38.4 kbit/s, the PC/PPI cable can be used as an RS232/RS485 converter	Yes; as a freely programmable interface with an interrupt option for serial data transmission with external units with ASCII protocol baud rates: 0.3/0.6/1.2/2.4/4.8/9.6/19.2/38.4 kbit/s; at 1.2 to 38.4 kbit/s, the PC/PPI cable can be used as an RS232/RS485 converter	Yes; as a freely programmable interface with an interrupt option for serial data transmission with external units with ASCII protocol baud rates: 0.3/0.6/1.2/2.4/4.8/9.6/19.2/38.4 kbit/s; at 1.2 to 38.4 kbit/s, the PC/PPI cable can be used as an RS232/RS485 converter

SIMATIC S7-200

Central processing units

CPU 221, 222, 224, 224 XP, 226

3

Technical specifications (continued)

	6ES7 211-0AA23-0XB0	6ES7 211-0BA23-0XB0	6ES7 212-1AB23-0XB0	6ES7 212-1BB23-0XB0
MPI				
- Transmission rates, max.	187.5 kBit/s	187.5 kBit/s	187.5 kBit/s	187.5 kBit/s
- Transmission rates, min.	19.2 kBit/s	19.2 kBit/s	19.2 kBit/s	19.2 kBit/s
CPU/ programming				
Programming language				
- LAD	Yes	Yes	Yes	Yes
- FBD	Yes	Yes	Yes	Yes
- STL	Yes	Yes	Yes	Yes
•Instruction set	Bit logic instructions, compare instructions, timer instructions, counter instructions, clock instructions, integer math instructions, floating-point math instructions, numeric functions, move instructions, table instructions, logic instructions, shift and rotate instructions, conversion instructions, program control instructions, interrupt and communications instructions, logic stack instructions	Bit logic instructions, compare instructions, timer instructions, counter instructions, clock instructions, integer math instructions, floating-point math instructions, numeric functions, move instructions, table instructions, logic instructions, shift and rotate instructions, conversion instructions, program control instructions, interrupt and communications instructions, logic stack instructions	Bit logic instructions, compare instructions, timer instructions, counter instructions, clock instructions, integer math instructions, floating-point math instructions, numeric functions, move instructions, table instructions, logic instructions, shift and rotate instructions, conversion instructions, program control instructions, interrupt and communications instructions, logic stack instructions	Bit logic instructions, compare instructions, timer instructions, counter instructions, clock instructions, integer math instructions, floating-point math instructions, numeric functions, move instructions, table instructions, logic instructions, shift and rotate instructions, conversion instructions, program control instructions, interrupt and communications instructions, logic stack instructions
•User program protection/password protection	Yes; 3-stage password protection	Yes; 3-stage password protection	Yes; 3-stage password protection	Yes; 3-stage password protection
•Program execution	free cycle (OB 1), interrupt-driven, time-driven (1 to 255 ms)	free cycle (OB 1), interrupt-driven, time-driven (1 to 255 ms)	free cycle (OB 1), interrupt-driven, time-driven (1 to 255 ms)	free cycle (OB 1), interrupt-driven, time-driven (1 to 255 ms)
•Program organization	1 OB, 1 DB, 1 SDB sub-programs with/without parameter transfer	1 OB, 1 DB, 1 SDB sub-programs with/without parameter transfer	1 OB, 1 DB, 1 SDB sub-programs with/without parameter transfer	1 OB, 1 DB, 1 SDB sub-programs with/without parameter transfer
•Number of sub-programs, max.	64	64	64	64
Digital inputs				
•Number of digital inputs	6; integrated	6; integrated	8	8
Length of cable				
- Length of cable shielded, max	500 m; Standard input: 500m, fast counters: 50m	500 m; Standard input: 500m, fast counters: 50m	500 m; Standard input: 500m, fast counters: 50m	500 m; Standard input: 500m, fast counters: 50m
- Length of cable unshielded, max	300 m; not for high-speed signals	300 m; not for high-speed signals	300 m; not for high-speed signals	300 m; not for high-speed signals
•m/p reading	Yes; optional, per group	Yes; optional, per group	Yes; optional, per group	Yes; optional, per group
Input voltage				
- Rated value, DC	24 V	24 V	24 V	24 V
- for signal "0"	0 to 5 V	0 to 5 V	0 to 5 V	0 to 5 V
- for signal "1"	min. 15 V	min. 15 V	min. 15 V	min. 15 V
Input current				
- for 1 signal, typical	2.5 mA	2.5 mA	2.5 mA	2.5 mA
Input delay (at rated value of the input voltage)				
•For standard inputs				
- Parameterizable	Yes; all	Yes; all	Yes; all	Yes; all
- at 0 after 1, min.	0.2 ms	0.2 ms	0.2 ms	0.2 ms
- at 0 after 1, max.	12.8 ms	12.8 ms	12.8 ms	12.8 ms
•for alarm inputs				
- parameterizable	Yes; I0.0 to I0.3	Yes; I0.0 to I0.3	Yes; I0.0 to I0.3	Yes; I0.0 to I0.3
•for counters/technological functions				
- parameterizable	Yes; (E0.0 to E0.5) 30 kHz	Yes; (E0.0 to E0.5) 30 kHz	Yes; (E0.0 to E0.5) 30 kHz	Yes; (E0.0 to E0.5) 30 kHz

Technical specifications (continued)

	6ES7 211-0AA23-0XB0	6ES7 211-0BA23-0XB0	6ES7 212-1AB23-0XB0	6ES7 212-1BB23-0XB0
Digital outputs				
•Number of digital outputs	4; Transistor	4; Relay	6; Transistor	6; Relay
•Length of cable shielded, max.	500 m	500 m	500 m	500 m
•Length of cable unshielded, max.	150 m	150 m	150 m	150 m
•Short-circuit protection of the output	No; provided externally	No; provided externally	No; provided externally	No; provided externally
•Limitation of voltage induced on circuit interruption to	1 W		1 W	
Switching capacity of the outputs				
- at resistive load, max.	0.75 A	2 A	0.75 A	2 A
- at lamp load, max.	5 W	30 W DC, 200 W AC	5 W	30 W DC, 200 W AC
Output voltage				
- for 1 signal	20 V DC	L+/L1	20 V DC	L+/L1
Output current				
- for 1 signal rated value	750 mA	2 A	750 mA	2 A
- for 0 signal residual current, max.	0.1 mA	0 mA	10 µA	0 mA
Output delay at resistive load				
- "0" after "1", max.	15 µs; of standard outputs, max. (A0.2 to A0.3) 15 µs; of pulse outputs, max. (A0.0 to A0.1) 2 µs	10 ms; all outputs	15 µs; of standard outputs, max. (A0.2 to A0.5) 15 µs; of pulse outputs, max. (A0.0 to A0.1) 2 µs	10 ms; all outputs
- "1" after "0", max.	130 µs; of standard outputs, max. (A0.2 to A0.3) 100 µs; of pulse outputs, max. (A0.0 to A0.1) 10 µs	10 ms; all outputs	130 µs; of standard outputs, max. (A0.2 to A0.5) 100 µs; of pulse outputs, max. (A0.0 to A0.1) 10 µs	10 ms; all outputs
Parallel switching of 2 outputs				
- to increase power	Yes	No	Yes	No
Switching frequency				
- of pulse outputs, at resistive load, max.	20 kHz; A0.0 to A0.1		20 kHz; A0.0 to A0.1	
Summation current of the outputs (per group)				
- up to 40 °C, max.	3 A	6 A	4.5 A	6 A
- horizontal installation, up to 55 °C, max.	3 A	6 A	4.5 A	6 A
Relay outputs				
•Number of operating cycles		10,000,000; mechanical 10 million, at rated load voltage 100,000		10,000,000; mechanical 10 million, at rated load voltage 100,000
Analog inputs				
•Number of analog potentiometers	1; Analog potentiometer; resolution 8 bits	1; Analog potentiometer; resolution 8 bits	1; Analog potentiometer; resolution 8 bits	1; Analog potentiometer; resolution 8 bits
Sensor supply				
24 V - sensor supply				
- 24 V	Yes; permissible range: 15.4 to 28.8 V	Yes; permissible range: 20.4 to 28.8 V	Yes; permissible range: 15.4 to 28.8 V	Yes; permissible range: 20.4 to 28.8 V
- Short-circuit protection	Yes; electronic at 600 mA	Yes; electronic at 600 mA	Yes; electronic at 600 mA	Yes; electronic at 600 mA
- Output current, max.	180 mA	180 mA	180 mA	180 mA
Sensor				
Connectable encoders				
- 2-wire BERS	Yes	Yes	Yes	Yes
- permissible closed-circuit current (2-wire BERS), max.	1 mA	1 mA	1 mA	1 mA

SIMATIC S7-200

Central processing units

CPU 221, 222, 224, 224 XP, 226

3

Technical specifications (continued)

	6ES7 211-0AA23-0XB0	6ES7 211-0BA23-0XB0	6ES7 212-1AB23-0XB0	6ES7 212-1BB23-0XB0
Integral functions				
•Number of counters	4; fast counters (each 30 kHz), 32 bits (incl. sign), usable as up/down counter or for connecting 2 incremental encoders with 2 pulse trains offset by 90° (max. 20 kHz (A/B counter)); parameterizable enable and reset input; interrupt options (incl. Call up a sub-program with any content) when the set-point value is reached; change of count direction etc.	4; fast counters (each 30 kHz), 32 bits (incl. sign), usable as up/down counter or for connecting 2 incremental encoders with 2 pulse trains offset by 90° (max. 20 kHz (A/B counter)); parameterizable enable and reset input; interrupt options (incl. Call up a sub-program with any content) when the set-point value is reached; change of count direction etc.	4; fast counters (each 30 kHz), 32 bits (incl. sign), usable as up/down counter or for connecting 2 incremental encoders with 2 pulse trains offset by 90° (max. 20 kHz (A/B counter)); parameterizable enable and reset input; interrupt options (incl. Call up a sub-program with any content) when the set-point value is reached; change of count direction etc.	4; fast counters (each 30 kHz), 32 bits (incl. sign), usable as up/down counter or for connecting 2 incremental encoders with 2 pulse trains offset by 90° (max. 20 kHz (A/B counter)); parameterizable enable and reset input; interrupt options (incl. Call up a sub-program with any content) when the set-point value is reached; change of count direction etc.
•Count frequency (counters) max.	30 kHz	30 kHz	30 kHz	30 kHz
•Number of alarm inputs	4; 4 rising edges and/or 4 falling edges	4; 4 rising edges and/or 4 falling edges	4; 4 rising edges and/or 4 falling edges	4; 4 rising edges and/or 4 falling edges
•Number of pulse outputs	2; fast outputs, 20 kHz, with interrupt option; pulse width and frequency modulation	2; fast outputs, 20 kHz, with interrupt option; pulse width and frequency modulation	2; fast outputs, 20 kHz, with interrupt option; pulse width and frequency modulation	2; fast outputs, 20 kHz, with interrupt option; pulse width and frequency modulation
•Cut-off frequency (pulse)	20 kHz	20 kHz	20 kHz	20 kHz
Potentials/ electrical isolation				
Digital output functions				
- between the channels	Yes; Optocoupler	Yes; Relay	Yes; Optocoupler	Yes; Relay
- between the channels, in groups of	4	1 and 3	6	3
Digital input functions				
- between the channels	Yes	Yes	Yes	Yes
- between the channels, in groups of	2 and 4	2 and 4	4	4
Permissible potential difference				
•between different circuits	500 V DC between 24 V DC and 5 V DC	500 V DC between 24 V DC and 5 V DC; 1500 V AC between 24 V DC and 230 V AC	500 V DC between 24 V DC and 5 V DC	500 V DC between 24 V DC and 5 V DC; 1500 V AC between 24 V DC and 230 V AC
Environmental requirements				
•Environmental conditions	For other ambient conditions: see "S7-200 Programmable Controller, System Manual"	For other ambient conditions: see "S7-200 Programmable Controller, System Manual"	For other ambient conditions: see "S7-200 Programmable Controller, System Manual"	For other ambient conditions: see "S7-200 Programmable Controller, System Manual"
Operating temperature				
- vertical mounting, min.	0 °C	0 °C	0 °C	0 °C
- vertical mounting, max.	45 °C	45 °C	45 °C	45 °C
- horizontal mounting, min.	0 °C	0 °C	0 °C	0 °C
- horizontal mounting, max.	55 °C	55 °C	55 °C	55 °C
Air pressure				
- permissible range, min	860 hPa	860 hPa	860 hPa	860 hPa
- permissible range, max	1,080 hPa	1,080 hPa	1,080 hPa	1,080 hPa
Relative humidity				
- Operation, min.	5 %	5 %	5 %	5 %
- Operation, max.	95 %; RH stressing level 2 in accordance with IEC 1131-2	95 %; RH stressing level 2 in accordance with IEC 1131-2	95 %; RH stressing level 2 in accordance with IEC 1131-2	95 %; RH stressing level 2 in accordance with IEC 1131-2
Degree of protection and class of protection				
- IP 20	Yes	Yes	Yes	Yes
Dimensions and weight				
•Weight, approx.	270 g	310 g	270 g	310 g
•Width	90 mm	90 mm	90 mm	90 mm
•Height	80 mm	80 mm	80 mm	80 mm
•Depth	62 mm	62 mm	62 mm	62 mm

Technical specifications (continued)

	6ES7 214-1AD23-0XB0	6ES7 214-1BD23-0XB0	6ES7 214-2AD23-0XB0	6ES7 214-2BD23-0XB0	6ES7 216-2AD23-0XB0	6ES7 216-2BD23-0XB0
Supply voltages						
Rated value						
- 24 V DC	Yes		Yes		Yes	
- permissible range, lower limit (DC)	20.4 V		20.4 V		20.4 V	
- permissible range, upper limit (DC)	28.8 V		28.8 V		28.8 V	
- 120 V AC		Yes		Yes		Yes
- 230 V AC		Yes		Yes		Yes
- permissible range, lower limit (AC)		85 V		85 V		85 V
- permissible range, upper limit (AC)		264 V		264 V		264 V
- permissible frequency range, lower limit		47 Hz		47 Hz		47 Hz
- permissible frequency range, upper limit		63 Hz		63 Hz		63 Hz
Voltages and currents						
Load voltage L+						
- Rated value (DC)	24 V	24 V	24 V	24 V	24 V	24 V
- permissible range, lower limit (DC)	20.4 V	5 V	20.4 V	5 V	20.4 V	5 V
- permissible range, upper limit (DC)	28.8 V	30 V	28.8 V	30 V	28.8 V	30 V
Load voltage L1						
- Rated value (AC)		100 V; 100 to 230 V AC		100 V; 100 to 230 V AC		100 V; 100 to 230 V AC
- permissible range, lower limit (AC)		5 V		5 V		5 V
- permissible range, upper limit (AC)		250 V		250 V		250 V
- permissible frequency range, lower limit		47 Hz		47 Hz		47 Hz
- permissible frequency range, upper limit		63 Hz		63 Hz		63 Hz
Current consumption						
• Inrush current, max.	12 A; at 28.8 V	20 A; at 264 V	12 A; at 28.8 V	20 A; at 264 V	10 A; at 28.8 V	20 A; at 264 V
• from supply voltage L+, max.	700 mA; 110 to 700 mA, output current for expansion modules (5 V DC) 660 mA		900 mA; 120 to 900 mA, output current for expansion modules (5 V DC) 660 mA		1,050 mA; 150 to 1050 mA, output current for expansion modules (5 V DC) 1000 mA	
• from supply voltage L1, max.		200 mA; 30 to 100 mA (240 V), 60 to 200 mA (120 V); output current for expansion modules (5 V DC) 600 mA		220 mA; 35 to 100 mA (240 V), 70 to 220 mA (120 V); output current for expansion modules (5 V DC) 600 mA		320 mA; 40 to 160 mA (240 V), 80 to 320 mA (120 V); output current for expansion modules (5 V DC) 1000 mA
back-up battery						
- Backup time	100 h; (min. 70 h at 40 °C); 200 days (typ.) with optional battery module	100 h; (min. 70 h at 40 °C); 200 days (typ.) with optional battery module	100 h; (min. 70 h at 40 °C); 200 days (typ.) with optional battery module	100 h; (min. 70 h at 40 °C); 200 days (typ.) with optional battery module	100 h; (min. 70 h at 40 °C); 200 days (typ.) with optional battery module	100 h; (min. 70 h at 40 °C); 200 days (typ.) with optional battery module

SIMATIC S7-200

Central processing units

CPU 221, 222, 224, 224 XP, 226

3

Technical specifications (continued)

	6ES7 214-1AD23-0XB0	6ES7 214-1BD23-0XB0	6ES7 214-2AD23-0XB0	6ES7 214-2BD23-0XB0	6ES7 216-2AD23-0XB0	6ES7 216-2BD23-0XB0
Memory/backup						
Memory						
- Number of memory modules (optional)	1; pluggable memory module, content identical to integral EEPROM, in addition, recipes, data logs and other files can be saved.	1; pluggable memory module, content identical to integral EEPROM, in addition, recipes, data logs and other files can be saved.	1; pluggable memory module, content identical to integral EEPROM, in addition, recipes, data logs and other files can be saved.	1; pluggable memory module, content identical to integral EEPROM, in addition, recipes, data logs and other files can be saved.	1; pluggable memory module, content identical to integral EEPROM, in addition, recipes, data logs and other files can be saved.	1; pluggable memory module, content identical to integral EEPROM, in addition, recipes, data logs and other files can be saved.
•Data memory and program memory						
- Data memory, max.	8 KByte	8 KByte	10 KByte	10 KByte	10 KByte	10 KByte
- Program memory, max.	12 KByte; 8 Kbytes for active run-time edit	12 KByte; 8 Kbytes for active run-time edit	16 KByte; 12 Kbytes for active run-time edit	16 KByte; 12 Kbytes for active run-time edit	24 KByte; 16 Kbytes with active run-time edit	24 KByte; 16 Kbytes with active run-time edit
Backup						
- available	Yes; Program: entire program maintenance-free in integral EEPROM, programmable via CPU; data: entire DB 1 loaded from PG/PC maintenance-free in integral EEPROM, current values of DB 1 in RAM, retentive flags, timers, counters etc., maintenance free via super capacitor; optional battery	Yes; Program: entire program maintenance-free in integral EEPROM, programmable via CPU; data: entire DB 1 loaded from PG/PC maintenance-free in integral EEPROM, current values of DB 1 in RAM, retentive flags, timers, counters etc., maintenance free via super capacitor; optional battery	Yes; Program: entire program maintenance-free in integral EEPROM, programmable via CPU; data: entire DB 1 loaded from PG/PC maintenance-free in integral EEPROM, current values of DB 1 in RAM, retentive flags, timers, counters etc., maintenance free via super capacitor; optional battery	Yes; Program: entire program maintenance-free in integral EEPROM, programmable via CPU; data: entire DB 1 loaded from PG/PC maintenance-free in integral EEPROM, current values of DB 1 in RAM, retentive flags, timers, counters etc., maintenance free via super capacitor; optional battery	Yes; Program: entire program maintenance-free in integral EEPROM, programmable via CPU; data: entire DB 1 loaded from PG/PC maintenance-free in integral EEPROM, current values of DB 1 in RAM, retentive flags, timers, counters etc., maintenance free via super capacitor; optional battery	Yes; Program: entire program maintenance-free in integral EEPROM, programmable via CPU; data: entire DB 1 loaded from PG/PC maintenance-free in integral EEPROM, current values of DB 1 in RAM, retentive flags, timers, counters etc., maintenance free via super capacitor; optional battery
CPU/processing times						
•for bit instruction, max.	0.22 µs	0.22 µs	0.22 µs	0.22 µs	0.22 µs	0.22 µs
Timers/counters and their retentive characteristics						
S7 counter						
- Number	256	256	256	256	256	256
•of which retentive with battery						
- adjustable	Yes; via super capacitor or battery	Yes; via super capacitor or battery	Yes; via super capacitor or battery	Yes; via super capacitor or battery	Yes; via super capacitor or battery	Yes; via super capacitor or battery
- lower limit	1	1	1	1	1	1
- upper limit	256	256	256	256	256	256
•Counting range						
- lower limit	0	0	0	0	0	0
- upper limit	32,767	32,767	32,767	32,767	32,767	32,767

Technical specifications (continued)

	6ES7 214-1AD23-0XB0	6ES7 214-1BD23-0XB0	6ES7 214-2AD23-0XB0	6ES7 214-2BD23-0XB0	6ES7 216-2AD23-0XB0	6ES7 216-2BD23-0XB0
S7 times						
- Number	256	256	256	256	256	256
•of which retentive with battery						
- adjustable	Yes; via super capacitor or battery	Yes; via super capacitor or battery	Yes; via super capacitor or battery	Yes; via super capacitor or battery	Yes; via super capacitor or battery	Yes; via super capacitor or battery
- upper limit	64	64	64	64	64	64
•Timing range						
- lower limit	1 ms	1 ms	1 ms	1 ms	1 ms	1 ms
- upper limit	54 min; 4 times, 1 ms to 30 s 16 times, 10 ms to 5 min 236 times, 100 ms to 54 min	54 min; 4 times, 1 ms to 30 s 16 times, 10 ms to 5 min 236 times, 100 ms to 54 min	54 min; 4 times, 1 ms to 30 s 16 times, 10 ms to 5 min 236 times, 100 ms to 54 min	54 min; 4 times, 1 ms to 30 s 16 times, 10 ms to 5 min 236 times, 100 ms to 54 min	54 min; 4 times, 1 ms to 30 s 16 times, 10 ms to 5 min 236 times, 100 ms to 54 min	54 min; 4 times, 1 ms to 30 s 16 times, 10 ms to 5 min 236 times, 100 ms to 54 min
Data areas and their retentive characteristics						
Flags						
- Number	32 Byte	32 Byte	32 Byte	32 Byte	32 Byte	32 Byte
- adjustable retentivity	Yes; M0.0 to M31.7	Yes; M0.0 to M31.7	Yes; M0.0 to M31.7	Yes; M0.0 to M31.7	Yes; M0.0 to M31.7	Yes; M0.0 to M31.7
- of which retentive with battery	0 to 255, via super capacitor or battery, adjustable	0 to 255, via super capacitor or battery, adjustable	0 to 255, via super capacitor or battery, adjustable	0 to 255, via super capacitor or battery, adjustable	0 to 255, via super capacitor or battery, adjustable	0 to 255, via super capacitor or battery, adjustable
- of which retentive without battery	0 to 112 in EEPROM, adjustable	0 to 112 in EEPROM, adjustable	0 to 112 in EEPROM, adjustable	0 to 112 in EEPROM, adjustable	0 to 112 in EEPROM, adjustable	0 to 112 in EEPROM, adjustable
Configuration						
•Connectable programming devices/PCs	SIMATIC PG/PC, Standard PC	SIMATIC PG/PC, Standard PC	SIMATIC PG/PC, Standard PC	SIMATIC PG/PC, Standard PC	SIMATIC PG/PC, Standard PC	SIMATIC PG/PC, Standard PC
•Central units/expansion units, max.	7 expansion modules. Only expansion modules of the S7-22x series can be used. (Because of the limited output current, the use of expansion modules may be subject to restrictions.)	7 expansion modules. Only expansion modules of the S7-22x series can be used. (Because of the limited output current, the use of expansion modules may be subject to restrictions.)	7 expansion modules. Only expansion modules of the S7-22x series can be used. (Because of the limited output current, the use of expansion modules may be subject to restrictions.)	7 expansion modules. Only expansion modules of the S7-22x series can be used. (Because of the limited output current, the use of expansion modules may be subject to restrictions.)	7 expansion modules. Only expansion modules of the S7-22x series can be used. (Because of the limited output current, the use of expansion modules may be subject to restrictions.)	7 expansion modules. Only expansion modules of the S7-22x series can be used. (Because of the limited output current, the use of expansion modules may be subject to restrictions.)
I/O expansions						
- Analog inputs/outputs, max.	35; max. 28 inputs and 7 outputs (EM) or max. 0 inputs and 14 outputs (EM)	35; max. 28 inputs and 7 outputs (EM) or max. 0 inputs and 14 outputs (EM)	38; 2 on board inputs and one output, in addition max. 28 inputs and 7 outputs (EM) or max. 0 inputs and 14 outputs (EM)	38; 2 on board inputs and one output, in addition max. 28 inputs and 7 outputs (EM) or max. 0 inputs and 14 outputs (EM)	35; max. 28 inputs and 7 outputs (EM) or max. 0 inputs and 14 outputs (EM)	35; max. 28 inputs and 7 outputs (EM) or max. 0 inputs and 14 outputs (EM)
- Digital inputs/outputs, max.	168; max. 94 inputs and 74 outputs (CPU+EM)	168; max. 94 inputs and 74 outputs (CPU+EM)	168; max. 94 inputs and 74 outputs (CPU+EM)	168; max. 94 inputs and 74 outputs (CPU+EM)	148; max. 128 inputs and 120 outputs (CPU+EM)	148; max. 128 inputs and 120 outputs (CPU+EM)
- AS interface inputs/outputs, max.	62; AS interface A/B slaves (CP 243-2)	62; AS interface A/B slaves (CP 243-2)	62; AS interface A/B slaves (CP 243-2)	62; AS interface A/B slaves (CP 243-2)	62; AS interface A/B slaves (CP 243-2)	62; AS interface A/B slaves (CP 243-2)

SIMATIC S7-200

Central processing units

CPU 221, 222, 224, 224 XP, 226

3

Technical specifications (continued)

	6ES7 214-1AD23-0XB0	6ES7 214-1BD23-0XB0	6ES7 214-2AD23-0XB0	6ES7 214-2BD23-0XB0	6ES7 216-2AD23-0XB0	6ES7 216-2BD23-0XB0
Connection system						
•Pluggable I/O terminals	Yes	Yes	Yes	Yes	Yes	Yes
1st interface						
•Type of interface	integrated RS 485 interface	integrated RS 485 interface	integrated RS 485 interface	integrated RS 485 interface	integrated RS 485 interface	integrated RS 485 interface
•Physical	RS 485	RS 485	RS 485	RS 485	RS 485	RS 485
Functionality						
- MPI	Yes; as MPI Slave for data exchange with MPI Masters (S7-300/S7-400-CPU, OPs, TDs, Push Button Panels); internal S7-200 CPU/CPU communication is limited in the MPI network; transmission rates 19.2/187.5 kbit/s	Yes; as MPI Slave for data exchange with MPI Masters (S7-300/S7-400-CPU, OPs, TDs, Push Button Panels); internal S7-200 CPU/CPU communication is limited in the MPI network; transmission rates 19.2/187.5 kbit/s	Yes; as MPI Slave for data exchange with MPI Masters (S7-300/S7-400-CPU, OPs, TDs, Push Button Panels); internal S7-200 CPU/CPU communication is limited in the MPI network; transmission rates 19.2/187.5 kbit/s	Yes; as MPI Slave for data exchange with MPI Masters (S7-300/S7-400-CPU, OPs, TDs, Push Button Panels); internal S7-200 CPU/CPU communication is limited in the MPI network; transmission rates 19.2/187.5 kbit/s	Yes; as MPI Slave for data exchange with MPI Masters (S7-300/S7-400-CPU, OPs, TDs, Push Button Panels); internal S7-200 CPU/CPU communication is limited in the MPI network; transmission rates 19.2/187.5 kbit/s	Yes; as MPI Slave for data exchange with MPI Masters (S7-300/S7-400-CPU, OPs, TDs, Push Button Panels); internal S7-200 CPU/CPU communication is limited in the MPI network; transmission rates 19.2/187.5 kbit/s
- PPI	Yes; with PPI protocol for programming functions, HMI functions (TD 200, OP), S7-200 internal CPU/CPU communication; transmission rates 9.6/19.2/187.5 kbit/s	Yes; with PPI protocol for programming functions, HMI functions (TD 200, OP), S7-200 internal CPU/CPU communication; transmission rates 9.6/19.2/187.5 kbit/s	Yes; with PPI protocol for programming functions, HMI functions (TD 200, OP), S7-200 internal CPU/CPU communication; transmission rates 9.6/19.2/187.5 kbit/s	Yes; with PPI protocol for programming functions, HMI functions (TD 200, OP), S7-200 internal CPU/CPU communication; transmission rates 9.6/19.2/187.5 kbit/s	Yes; with PPI protocol for programming functions, HMI functions (TD 200, OP), S7-200 internal CPU/CPU communication; transmission rates 9.6/19.2/187.5 kbit/s	Yes; with PPI protocol for programming functions, HMI functions (TD 200, OP), S7-200 internal CPU/CPU communication; transmission rates 9.6/19.2/187.5 kbit/s
- Serial data transmission	Yes; as a freely programmable interface with an interrupt option for serial data transmission with external units with ASCII protocol baud rates: 0.3/0.6/1.2/2.4/4.8/9.6/19.2/38.4 kbit/s; at 1.2 to 38.4 kbit/s, the PC/PPI cable can be used as an RS232/RS485 converter	Yes; as a freely programmable interface with an interrupt option for serial data transmission with external units with ASCII protocol baud rates: 0.3/0.6/1.2/2.4/4.8/9.6/19.2/38.4 kbit/s; at 1.2 to 38.4 kbit/s, the PC/PPI cable can be used as an RS232/RS485 converter	Yes; as a freely programmable interface with an interrupt option for serial data transmission with external units with ASCII protocol baud rates: 0.3/0.6/1.2/2.4/4.8/9.6/19.2/38.4 kbit/s; at 1.2 to 38.4 kbit/s, the PC/PPI cable can be used as an RS232/RS485 converter	Yes; as a freely programmable interface with an interrupt option for serial data transmission with external units with ASCII protocol baud rates: 0.3/0.6/1.2/2.4/4.8/9.6/19.2/38.4 kbit/s; at 1.2 to 38.4 kbit/s, the PC/PPI cable can be used as an RS232/RS485 converter	Yes; as a freely programmable interface with an interrupt option for serial data transmission with external units with ASCII protocol baud rates: 0.3/0.6/1.2/2.4/4.8/9.6/19.2/38.4 kbit/s; at 1.2 to 38.4 kbit/s, the PC/PPI cable can be used as an RS232/RS485 converter	Yes; as a freely programmable interface with an interrupt option for serial data transmission with external units with ASCII protocol baud rates: 0.3/0.6/1.2/2.4/4.8/9.6/19.2/38.4 kbit/s; at 1.2 to 38.4 kbit/s, the PC/PPI cable can be used as an RS232/RS485 converter
MPI						
- Transmission rates, max.	187.5 kBit/s	187.5 kBit/s	187.5 kBit/s	187.5 kBit/s	187.5 kBit/s	187.5 kBit/s
- Transmission rates, min.	19.2 kBit/s	19.2 kBit/s	19.2 kBit/s	19.2 kBit/s	19.2 kBit/s	19.2 kBit/s

Technical specifications (continued)

	6ES7 214-1AD23-0XB0	6ES7 214-1BD23-0XB0	6ES7 214-2AD23-0XB0	6ES7 214-2BD23-0XB0	6ES7 216-2AD23-0XB0	6ES7 216-2BD23-0XB0
2nd interface						
•Type of interface			integrated RS 485 interface	integrated RS 485 interface	integrated RS 485 interface	integrated RS 485 interface
•Physical			RS 485	RS 485	RS 485	RS 485
Functionality						
- MPI			Yes; as MPI Slave for data exchange with MPI Masters (S7-300/S7-400-CPU, OPs, TDs, Push Button Panels); internal S7-200 CPU/CPU communication is limited in the MPI network; transmission rates 19.2/187.5 kbit/s	Yes; as MPI Slave for data exchange with MPI Masters (S7-300/S7-400-CPU, OPs, TDs, Push Button Panels); internal S7-200 CPU/CPU communication is limited in the MPI network; transmission rates 19.2/187.5 kbit/s	Yes; as MPI Slave for data exchange with MPI Masters (S7-300/S7-400-CPU, OPs, TDs, Push Button Panels); internal S7-200 CPU/CPU communication is limited in the MPI network; transmission rates 19.2/187.5 kbit/s	Yes; as MPI Slave for data exchange with MPI Masters (S7-300/S7-400-CPU, OPs, TDs, Push Button Panels); internal S7-200 CPU/CPU communication is limited in the MPI network; transmission rates 19.2/187.5 kbit/s
- PPI			Yes; with PPI protocol for programming functions, HMI functions (TD 200, OP), S7-200 internal CPU/CPU communication; transmission rates 9.6/19.2/187.5 kbit/s	Yes; with PPI protocol for programming functions, HMI functions (TD 200, OP), S7-200 internal CPU/CPU communication; transmission rates 9.6/19.2/187.5 kbit/s	Yes; with PPI protocol for programming functions, HMI functions (TD 200, OP), S7-200 internal CPU/CPU communication; transmission rates 9.6/19.2/187.5 kbit/s	Yes; with PPI protocol for programming functions, HMI functions (TD 200, OP), S7-200 internal CPU/CPU communication; transmission rates 9.6/19.2/187.5 kbit/s
- Serial data transmission			Yes; as a freely programmable interface with an interrupt option for serial data transmission with external units with ASCII protocol baud rates: 0.3/0.6/1.2/2.4/4.8/9.6/19.2/38.4 kbit/s; at 1.2 to 38.4 kbit/s, the PC/PPI cable can be used as an RS232/RS485 converter	Yes; as a freely programmable interface with an interrupt option for serial data transmission with external units with ASCII protocol baud rates: 0.3/0.6/1.2/2.4/4.8/9.6/19.2/38.4 kbit/s; at 1.2 to 38.4 kbit/s, the PC/PPI cable can be used as an RS232/RS485 converter	Yes; as a freely programmable interface with an interrupt option for serial data transmission with external units with ASCII protocol baud rates: 0.3/0.6/1.2/2.4/4.8/9.6/19.2/38.4 kbit/s; at 1.2 to 38.4 kbit/s, the PC/PPI cable can be used as an RS232/RS485 converter	Yes; as a freely programmable interface with an interrupt option for serial data transmission with external units with ASCII protocol baud rates: 0.3/0.6/1.2/2.4/4.8/9.6/19.2/38.4 kbit/s; at 1.2 to 38.4 kbit/s, the PC/PPI cable can be used as an RS232/RS485 converter
MPI						
- Transmission rate, max.			187.5 kBit/s	187.5 kBit/s	187.5 kBit/s	187.5 kBit/s
- Transmission rate, min.			19.2 kBit/s	19.2 kBit/s	19.2 kBit/s	19.2 kBit/s

SIMATIC S7-200

Central processing units

CPU 221, 222, 224, 224 XP, 226

3

Technical specifications (continued)

	6ES7 214-1AD23-0XB0	6ES7 214-1BD23-0XB0	6ES7 214-2AD23-0XB0	6ES7 214-2BD23-0XB0	6ES7 216-2AD23-0XB0	6ES7 216-2BD23-0XB0
CPU/ programming						
Programming language						
- LAD	Yes	Yes	Yes	Yes	Yes	Yes
- FBD	Yes	Yes	Yes	Yes	Yes	Yes
- STL	Yes	Yes	Yes	Yes	Yes	Yes
• Instruction set	Bit logic instructions, compare instructions, timer instructions, counter instructions, clock instructions, integer math instructions, floating-point math instructions, numeric functions, move instructions, table instructions, logic instructions, shift and rotate instructions, conversion instructions, program control instructions, interrupt and communications instructions, logic stack instructions	Bit logic instructions, compare instructions, timer instructions, counter instructions, clock instructions, integer math instructions, floating-point math instructions, numeric functions, move instructions, table instructions, logic instructions, shift and rotate instructions, conversion instructions, program control instructions, interrupt and communications instructions, logic stack instructions	Bit logic instructions, compare instructions, timer instructions, counter instructions, clock instructions, integer math instructions, floating-point math instructions, numeric functions, move instructions, table instructions, logic instructions, shift and rotate instructions, conversion instructions, program control instructions, interrupt and communications instructions, logic stack instructions	Bit logic instructions, compare instructions, timer instructions, counter instructions, clock instructions, integer math instructions, floating-point math instructions, numeric functions, move instructions, table instructions, logic instructions, shift and rotate instructions, conversion instructions, program control instructions, interrupt and communications instructions, logic stack instructions	Bit logic instructions, compare instructions, timer instructions, counter instructions, clock instructions, integer math instructions, floating-point math instructions, numeric functions, move instructions, table instructions, logic instructions, shift and rotate instructions, conversion instructions, program control instructions, interrupt and communications instructions, logic stack instructions	Bit logic instructions, compare instructions, timer instructions, counter instructions, clock instructions, integer math instructions, floating-point math instructions, numeric functions, move instructions, table instructions, logic instructions, shift and rotate instructions, conversion instructions, program control instructions, interrupt and communications instructions, logic stack instructions
• User program protection/password protection	Yes; 3-stage password protection	Yes; 3-stage password protection	Yes; 3-stage password protection	Yes; 3-stage password protection	Yes; 3-stage password protection	Yes; 3-stage password protection
• Program execution	free cycle (OB 1), interrupt-driven, time-driven (1 to 255 ms)	free cycle (OB 1), interrupt-driven, time-driven (1 to 255 ms)	free cycle (OB 1), interrupt-driven, time-driven (1 to 255 ms)	free cycle (OB 1), interrupt-driven, time-driven (1 to 255 ms)	free cycle (OB 1), interrupt-driven, time-driven (1 to 255 ms)	free cycle (OB 1), interrupt-driven, time-driven (1 to 255 ms)
• Program organization	1 OB, 1 DB, 1 SDB subprograms with/without parameter transfer	1 OB, 1 DB, 1 SDB subprograms with/without parameter transfer	1 OB, 1 DB, 1 SDB subprograms with/without parameter transfer	1 OB, 1 DB, 1 SDB subprograms with/without parameter transfer	1 OB, 1 DB, 1 SDB subprograms with/without parameter transfer	1 OB, 1 DB, 1 SDB subprograms with/without parameter transfer
• Number of sub-programs, max.	64	64	64	64	64	64
Digital inputs						
• Number of digital inputs	14	14	14	14	24	24
Length of cable						
- Length of cable shielded, max	500 m; Standard input: 500m, fast counters: 50m	500 m; Standard input: 500m, fast counters: 50m	500 m; Standard input: 500m, fast counters: 50m	500 m; Standard input: 500m, fast counters: 50m	500 m; Standard input: 500m, fast counters: 50m	500 m; Standard input: 500m, fast counters: 50m
- Length of cable unshielded, max	300 m; not for high-speed signals	300 m; not for high-speed signals	300 m; not for high-speed signals	300 m; not for high-speed signals	300 m; not for high-speed signals	300 m; not for high-speed signals
• m/p reading	Yes; optional, per group	Yes; optional, per group	Yes; optional, per group	Yes; optional, per group	Yes; optional, per group	Yes; optional, per group
Input voltage						
- Rated value, DC	24 V	24 V	24 V	24 V	24 V	24 V
- for signal "0"	0 to 5 V	0 to 5 V	0 to 5 V; 0 to 1V (I0.3 to I0.5)	0 to 5 V0 to 1V (I0.3 to I0.5)	0 to 5 V	0 to 5 V
- for signal "1"	min. 15 V	min. 15 V	min. 15 V; at least 4V (I0.3 to I0.5)	min. 15 V at least 4V (I0.3 to I0.5)	min. 15 V	min. 15 V
Input current						
- for 1 signal, typical	2.5 mA	2.5 mA	2.5 mA; 8 mA for I0.3 to I0.5	2.5 mA; 8 mA for I0.3 to I0.5	2.5 mA	2.5 mA

Technical specifications (continued)

	6ES7 214-1AD23-0XB0	6ES7 214-1BD23-0XB0	6ES7 214-2AD23-0XB0	6ES7 214-2BD23-0XB0	6ES7 216-2AD23-0XB0	6ES7 216-2BD23-0XB0
Input delay (at rated value of the input voltage)						
•For standard inputs						
- Parameterizable	Yes; all	Yes; all	Yes; all	Yes; all	Yes; all	Yes; all
- at 0 after 1, min.	0.2 ms	0.2 ms	0.2 ms	0.2 ms	0.2 ms	0.2 ms
- at 0 after 1, max.	12.8 ms	12.8 ms	12.8 ms	12.8 ms	12.8 ms	12.8 ms
•for alarm inputs						
- parameterizable	Yes; I0.0 to I0.3	Yes; I0.0 to I0.3	Yes; I0.0 to I0.3	Yes; I0.0 to I0.3	Yes; I0.0 to I0.3	Yes; I0.0 to I0.3
•for counters/technological functions						
- parameterizable	Yes; (E0.0 to E1.5) 30 kHz	Yes; (E0.0 to E1.5) 30 kHz	Yes; (E0.0 to E1.5) up to 200 kHz	Yes; (E0.0 to E1.5) up to 200 kHz	Yes; (E0.0 to E1.5) 30 kHz	Yes; (E0.0 to E1.5) 30 kHz
Digital outputs						
•Number of digital outputs	10; Transistor	10; Relay	10; Transistor	10; Relay	16; Transistor	16; Relay
•Length of cable shielded, max.	500 m	500 m	500 m	500 m	500 m	500 m
•Length of cable unshielded, max.	150 m	150 m	150 m	150 m	150 m	150 m
•Short-circuit protection of the output	No; provided externally	No; provided externally	No; provided externally	No; provided externally	No; provided externally	No; provided externally
•Limitation of voltage induced on circuit interruption to	1 W		1 W		1 W	
Switching capacity of the outputs						
- at resistive load, max.	0.75 A	2 A	0.75 A	2 A	0.75 A	2 A
- at lamp load, max.	5 W	200 W; 30 W DC, 200 W AC	5 W	200 W; 30 W DC, 200 W AC	5 W	200 W; 30 W DC, 200 W AC
Output voltage						
- for 1 signal	20 V DC	L+/L1	L+ minus 0.4V (5V/20.4V for A0.0 to A0.4; 20.4V A0.5 to A1.1)	L+/L1	20 V DC	L+/L1
Output current						
- for 1 signal rated value	750 mA	2 A	750 mA	2 A	750 mA	2 A
- for 0 signal residual current, max.	10 µA	0 mA	10 µA	0 mA	10 µA	0 mA
Output delay at resistive load						
- "0" after "1", max.	15 µs; of the standard outputs, max. (A0.2 to A1.1) 2 µs; of the pulse outputs, max. (A0.0 to A0.1) 2 µs	10 ms; all outputs	15 µs; of the standard outputs, max. (A0.2 to A1.1) 15 µs; of the pulse outputs, max. (A0.0 to A0.1) 0.5 µs	10 ms; all outputs	15 µs; of the standard outputs, max. (A0.2 to A1.1) 2 µs; of the pulse outputs, max. (A0.0 to A0.1) 2 µs	10 ms; all outputs
- "1" after "0", max.	130 µs; of the standard outputs, max. (A0.2 to A1.1) 10 µs; of the pulse outputs, max. (A0.0 to A0.1) 10 µs	10 ms; all outputs	130 µs; of the standard outputs, max. (A0.2 to A1.1) 130 µs; of the pulse outputs, max. (A0.0 to A0.1) 1.5 µs	10 ms; all outputs	130 µs; of the standard outputs, max. (A0.2 to A1.1) 10 µs; of the pulse outputs, max. (A0.0 to A0.1) 10 µs	10 ms; all outputs
Parallel switching of 2 outputs						
- to increase power	Yes	No	Yes	No	Yes	No
Switching frequency						
- of pulse outputs, at resistive load, max.	20 kHz; A0.0 to A0.1	1 Hz	100 kHz; A0.0 to A0.1	1 Hz	20 kHz; A0.0 to A0.1	1 kHz
Summation current of the outputs (per group)						
- up to 40 °C, max.	6 A	10 A	3.75 A	10 A	6 A	10 A
- horizontal installation, up to 55 °C, max.	6 A	10 A	3.75 A	10 A	6 A	10 A

SIMATIC S7-200

Central processing units

CPU 221, 222, 224, 224 XP, 226

3

Technical specifications (continued)

	6ES7 214-1AD23-0XB0	6ES7 214-1BD23-0XB0	6ES7 214-2AD23-0XB0	6ES7 214-2BD23-0XB0	6ES7 216-2AD23-0XB0	6ES7 216-2BD23-0XB0
Relay outputs						
•Number of operating cycles		10,000,000; mechanical 10 million, at rated load voltage 100,000		10,000,000; mechanical 10 million, at rated load voltage 100,000		10,000,000; mechanical 10 million, at rated load voltage 100,000
Analog inputs						
•Number of analog potentiometers	2; Analog potentiometer; resolution 8 bits	2; Analog potentiometer; resolution 8 bits	2; Analog potentiometer; resolution 8 bits	2; Analog potentiometer; resolution 8 bits	2; Analog potentiometer; resolution 8 bits	2; Analog potentiometer; resolution 8 bits
Sensor supply						
24 V - sensor supply						
- 24 V	Yes; permissible range: 15.4 to 28.8 V	Yes; permissible range: 20.4 to 28.8 V	Yes; permissible range: 15.4 to 28.8 V	Yes; permissible range: 20.4 to 28.8 V	Yes; permissible range: 15.4 to 28.8 V	Yes; permissible range: 20.4 to 28.8 V
- Short-circuit protection	Yes; electronic at 280 mA	Yes; electronic at 280 mA	Yes; electronic at 280 mA	Yes; electronic at 280 mA	Yes; electronic at 400 mA	Yes; electronic at 400mA
- Output current, max.	280 mA	280 mA	280 mA	280 mA	400 mA	400 mA
Sensor						
Connectable encoders						
- 2-wire Beros	Yes	Yes	Yes	Yes	Yes	Yes
- permissible closed-circuit current (2-wire Beros), max.	1 mA	1 mA	1 mA	1 mA	1 mA	1 mA
Integral functions						
•Number of counters	6; fast counters (each 30 kHz), 32 bits (incl. sign), usable as up/down counter or for connecting 4 incremental encoders with 2 pulse trains offset by 90° (max. 20 kHz (A/B counter)); parameterizable enable and reset input; interrupt options (incl. Call up a sub-program with any content) when the setpoint value is reached; change of count direction etc.	6; fast counters (each 30 kHz), 32 bits (incl. sign), usable as up/down counter or for connecting 4 incremental encoders with 2 pulse trains offset by 90° (max. 20 kHz (A/B counter)); parameterizable enable and reset input; interrupt options (incl. Call up a sub-program with any content) when the setpoint value is reached; change of count direction etc.	6; fast counters (2 to 200 kHz and 4 to 30 kHz), 32 bits (incl. sign), usable as up/down counter or for connecting 2 incremental encoders with 2 pulse trains offset by 90° (max. 1 to 100 kHz and 3 to 20 kHz (A/B counter)); parameterizable enable and reset input; interrupt options (incl. Call up a sub-program with any content) when the setpoint value is reached; change of count direction etc.	6; fast counters (2 to 200 kHz and 4 to 30 kHz), 32 bits (incl. sign), usable as up/down counter or for connecting 2 incremental encoders with 2 pulse trains offset by 90° (max. 1 to 100 kHz and 3 to 20 kHz (A/B counter)); parameterizable enable and reset input; interrupt options (incl. Call up a sub-program with any content) when the setpoint value is reached; change of count direction etc.	6; fast counters (each 30 kHz), 32 bits (incl. sign), usable as up/down counter or for connecting 4 incremental encoders with 2 pulse trains offset by 90° (max. 20 kHz (A/B counter)); parameterizable enable and reset input; interrupt options (incl. Call up a sub-program with any content) when the setpoint value is reached; change of count direction etc.	6; fast counters (each 30 kHz), 32 bits (incl. sign), usable as up/down counter or for connecting 4 incremental encoders with 2 pulse trains offset by 90° (max. 20 kHz (A/B counter)); parameterizable enable and reset input; interrupt options (incl. Call up a sub-program with any content) when the setpoint value is reached; change of count direction etc.
•Count frequency (counters) max.	30 kHz	30 kHz	200 kHz	200 kHz	30 kHz	30 kHz
•Number of alarm inputs	4; 4 rising edges and/or 4 falling edges	4; 4 rising edges and/or 4 falling edges	4; 4 rising edges and/or 4 falling edges	4; 4 rising edges and/or 4 falling edges	4; 4 rising edges and/or 4 falling edges	4; 4 rising edges and/or 4 falling edges
•Number of pulse outputs	2; fast outputs, 20 kHz, with interrupt option; pulse width and frequency modulation	2; fast outputs, 20 kHz, with interrupt option; pulse width and frequency modulation	2; fast outputs, 20 kHz, with interrupt option; pulse width and frequency modulation	2; fast outputs, 20 kHz, with interrupt option; pulse width and frequency modulation	2; fast outputs, 20 kHz, with interrupt option; pulse width and frequency modulation	2; fast outputs, 20 kHz, with interrupt option; pulse width and frequency modulation
•Cut-off frequency (pulse)	20 kHz	20 kHz	20 kHz	20 kHz	20 kHz	20 kHz

Technical specifications (continued)

	6ES7 214-1AD23-0XB0	6ES7 214-1BD23-0XB0	6ES7 214-2AD23-0XB0	6ES7 214-2BD23-0XB0	6ES7 216-2AD23-0XB0	6ES7 216-2BD23-0XB0
Potentials/ electrical isolation						
Digital output functions						
- between the channels	Yes; Optocoupler	Yes; Relay	Yes; Optocoupler	Yes; Relay	Yes; Optocoupler	Yes; Relay
- between the channels, in groups of	5	3, 3 and 4	5	3, 3 and 4	8 and 8	4, 5 and 7
Digital input functions						
- between the channels	Yes	Yes	Yes	Yes	Yes	Yes; Optocoupler
- between the channels, in groups of	6 and 8	6 and 8	6 and 8	6 and 8	13 and 11	13 and 11
Permissible potential difference						
•between different circuits	500 V DC between 24 V DC and 5 V DC	500 V DC between 24 V DC and 5 V DC; 1500 V AC between 24 V DC and 230 V AC	500 V DC between 24 V DC and 5 V DC	500 V DC between 24 V DC and 5 V DC; 1500 V AC between 24 V DC and 230 V AC	500 V DC between 24 V DC and 5 V DC	500 V DC between 24 V DC and 5 V DC; 1500 V AC between 24 V DC and 230 V AC
Environmental requirements						
•Environmental conditions	For other ambient conditions: see "S7-200 Programmable Controller, System Manual"	For other ambient conditions: see "S7-200 Programmable Controller, System Manual"	For other ambient conditions: see "S7-200 Programmable Controller, System Manual"	For other ambient conditions: see "S7-200 Programmable Controller, System Manual"	For other ambient conditions: see "S7-200 Programmable Controller, System Manual"	For other ambient conditions: see "S7-200 Programmable Controller, System Manual"
Operating temperature						
- vertical mounting, min.	0 °C	0 °C	0 °C	0 °C	0 °C	0 °C
- vertical mounting, max.	45 °C	45 °C	45 °C	45 °C	45 °C	45 °C
- horizontal mounting, min.	0 °C	0 °C	0 °C	0 °C	0 °C	0 °C
- horizontal mounting, max.	55 °C	55 °C	55 °C	55 °C	55 °C	55 °C
Air pressure						
- permissible range, min	860 hPa	860 hPa	860 hPa	860 hPa	860 hPa	860 hPa
- permissible range, max	1,080 hPa	1,080 hPa	1,080 hPa	1,080 hPa	1,080 hPa	1,080 hPa
Relative humidity						
- Operation, min.	5 %	5 %	5 %	5 %	5 %	5 %
- Operation, max.	95 %; RH stressing level 2 in accordance with IEC 1131-2	95 %; RH stressing level 2 in accordance with IEC 1131-2	95 %; RH stressing level 2 in accordance with IEC 1131-2	95 %; RH stressing level 2 in accordance with IEC 1131-2	95 %; RH stressing level 2 in accordance with IEC 1131-2	95 %; RH stressing level 2 in accordance with IEC 1131-2
Degree of protection and class of protection						
- IP 20	Yes	Yes	Yes	Yes	Yes	Yes
Dimensions and weight						
•Weight, approx.	360 g	410 g	390 g	440 g	550 g	660 g
•Width	120.5 mm	120.5 mm	140 mm	140 mm	196 mm	196 mm
•Height	80 mm	80 mm	80 mm	80 mm	80 mm	80 mm
•Depth	62 mm	62 mm	62 mm	62 mm	62 mm	62 mm

SIMATIC S7-200

Central processing units

CPU 221, 222, 224, 224 XP, 226

3

Ordering Data	Order No.	Order No.
CPU 221		
Compact CPU, 4 KB RAM, 24 V DC supply voltage, 6 DI/4 DO integrated ^{A)}	6ES7 211-0AA23-0XB0	
Compact CPU, 4 KB RAM, 100 to 230 V AC supply voltage, 6 DI/4 DO integrated, relay outputs ^{A)}	6ES7 211-0BA23-0XB0	
CPU 222		
Compact CPU, expandable, 4 KB RAM, 24 V DC supply voltage, 8 DI/6 DO integrated ^{A)}	6ES7 212-1AB23-0XB0	
Compact CPU, expandable, 4 KB RAM, 100-230 V AC, 8 DI/6 DO integrated, relay outputs ^{A)}	6ES7 212-1BB23-0XB0	
CPU 224		
Compact CPU, expandable, 8/12 KB RAM for program, 8 KB RAM for data, 24 V DC supply voltage, 14 DI/10 DO, integrated ^{A)}	6ES7 214-1AD23-0XB0	
Compact CPU, expandable, 8/12 KB RAM for program, 8 KB RAM for data, 100 - 230 V AC supply voltage, 14 DI/10 DO, integrated, relay outputs ^{A)}	6ES7 214-1BD23-0XB0	
CPU 224 XP		
Compact CPU, expandable, 12/16 KB RAM for program, 10 KB RAM for data, 24 V DC supply voltage, 14 DI/10 DO/ 2 AI/1 AO integrated ^{A)}	6ES7 214-2AD23-0XB0	
Compact CPU, expandable, 12/16 KB RAM for program, 10 KB RAM for data, 100 - 230 V AC supply voltage, 14 DI/10 DO (relay outputs) 2 AI/1 AO integrated ^{A)}	6ES7 214-2BD23-0XB0	
CPU 226		
Compact CPU, expandable, 16/24 KB RAM for program, 10 KB RAM for data, 24 V DC supply voltage, 24 DI/16 DO, integrated ^{A)}	6ES7 216-2AD23-0XB0	
Compact CPU, expandable, 16/24 KB RAM for program, 10 KB RAM for data, 100 - 230 V AC supply voltage, 24 DI/16 DO, integrated, relay outputs ^{A)}	6ES7 216-2BD23-0XB0	
S7-200 True Power Box		
Complete package consisting of CPU 222, STEP 7 Micro/WIN V3, combined clock and battery modules, intelligent RS 232/PPI multimaster cable, manual; delivered in a practical box		
German ^{C)}		6ES7 298-0AA20-0AA2
English ^{C)}		6ES7 298-0AA20-0BA2
French ^{C)}		6ES7 298-0AA20-0CA2
Spanish ^{C)}		6ES7 298-0AA20-0DA2
Italian ^{C)}		6ES7 298-0AA20-0EA2
Memory module MC 291, EEPROM ^{A)}		6ES7 291-8GE20-0XA0
for CPU 221/222/224/224 XP/226		
Memory module MC 291, EEPROM ^{A)}		
for CPU 221/222/224/224 XP/226		
64 KB ^{A)}		6ES7 291-8GF23-0XA0
256 KB ^{A)}		6ES7 291-8GH23-0XA0
Grounding terminal		6ES5 728-8MA11
10 items		
Front flap set ^{A)}		6ES7 291-3AX20-0XA0
contains different covering flaps for CPU and EM; Spare part		
SIM 274 simulator (optional)		
with 8 connection terminals for CPU 221/222 ^{A)}		6ES7 274-1XF00-0XA0
with 14 connection terminals for CPU 224/224 XP ^{A)}		6ES7 274-1XH00-0XA0
with 24 connection terminals for CPU 226 ^{A)}		6ES7 274-1XK00-0XA0
Terminal block for field wiring (optional)		
for CPU 221/222, 10 items ^{A)}		6ES7 290-2AA00-0XA0
for CPU 224, 10 items ^{A)}		6ES7 290-2BA00-0XA0
Plug-in terminal block (spare part)		
with 12 connections (for CPU 22x) ^{A)}		6ES7 292-1AE20-0AA0
with 18 connections (for CPU 224) ^{A)}		6ES7 292-1AG20-0AA0
with 14 connection terminals (for CPU 226/226 XM) ^{A)}		6ES7 292-1AF20-0AA0
Intelligent RS 232/PPI multimaster cable ^{A)}		6ES7 901-3CB30-0XA0
for connecting devices with an RS 232 interface to the SIMATIC S7-200 or PPI network; master in the multimaster PPI network		
Intelligent USB/PPI multimaster cable ^{A)}		6ES7 901-3DB30-0XA0
for connecting devices with an USB interface to the SIMATIC S7-200 or PPI network; master in the multimaster PPI network		
MPI cable		6ES7 901-0BF00-0AA0
5 m for connecting the S7-200 to the MPI		

A) Subject to export regulations: AL: N and ECCN: EAR99H

C) Subject to export regulations: AL: N and ECCN: EAR99T

SIMATIC S7-200

Central processing units

CPU 221, 222, 224, 224 XP, 226

3

Ordering Data	Order No.	Order No.
Backplane bus expansion cable ^{A)} for connecting the two equipment tiers in a two-tier configuration, for CUP 222/224/224 XP/226	6ES7 290-6AA20-0XA0	
Optional battery module ^{A)}	6ES7 291-8BA20-0XA0	
Optional combined clock and battery module ^{A)} for CPU 221/222 only	6ES7 297-1AA23-0XA0	
S7-200 programmable controller, system manual for CPU 221/222/224/224 XP/226 and STEP 7-Micro/Win V4		
German	6ES7 298-8FA24-8AH0	
English	6ES7 298-8FA24-8BH0	
French	6ES7 298-8FA24-8CH0	
Spanish	6ES7 298-8FA24-8DH0	
Italian	6ES7 298-8FA24-8EH0	
Chinese	6ES7 298-8FA24-8FH0	
SIMATIC Manual Collection ^{B)} Electronic manuals on CD-ROM, 5 languages: S7-200/300/400, C7, LOGO!, SIMATIC DP, PC, PG, STEP 7, Engineering Software, Runtime Software, PCS 7, SIMATIC HMI, SIMATIC NET	6ES7 998-8XC01-8YE0	
SIMATIC Manual Collection update service for 1 year ^{B)} Up-to-date Manual Collection CD as well as the three subsequent updates	6ES7 998-8XC01-8YE2	
		STEP 7 Micro/WIN V4 programming software
		<i>Target system:</i> All CPUs of the SIMATIC S7-200 range
		<i>Requirements:</i> Windows 2000/XP on PG or PC
		<i>delivery type:</i> English, German, French, Spanish, Italian, Chinese; with online documentation
		Single license ^{B)}
		6ES7 810-2CC03-0YX0
		Upgrade single license ^{1) B)}
		6ES7 810-2CC03-0YX3
		PROFIBUS bus connector IP20 with 90° cable feeder
		•without PG connection
		6ES7 972-0BA12-0XA0
		•with PG connection
		6ES7 972-0BB12-0XA0
		PROFIBUS bus connector IP20 with 35° cable feeder
		•without PG connection
		6ES7 972-0BA41-0XA0
		•with PG connection
		6ES7 972-0BB41-0XA0
		PROFIBUS FC Standard Cable
		6XV1 830-0EH10
		for connecting to PPI; standard type with special design for quick mounting, 2-wire, shielded, sold by the meter, up to 1000m, minimum order 20 m
		Repeater RS 485 for PROFIBUS
		6ES7 972-0AA01-0XA0

1) Upgrade for all previous STEP 7 Micro/WIN and STEP 7 Micro/DOS versions

A) Subject to export regulations: AL: N and ECCN: EAR99H

B) Subject to export regulations: AL: N and ECCN: EAR99S

SIMATIC S7-200

SIPLUS central processing units

SIPLUS central processing units

3

Overview



- The SIPLUS S7-200 CPUs for use in the harshest environmental conditions
- With extended temperature range from -25 to +70°C
- Suitable for extraordinary medi al load (pollution gas atmosphere)
- Occasional short-term condensation and increased mechanical loading permissible
- With the proven PLC technology of the S7-200
- Convenient handling, programming, maintenance and service
- The alternative to expensive custom solutions

More Information you can find at:

<http://www.siemens.com/siplus>

Overview



- Digital inputs/outputs to supplement the onboard I/Os of the CPUs
- For flexible adaptation of PLC to respective task
- For subsequent upgrading of the system with additional inputs
Ordering Data

Technical specifications EM 221

	6ES7 221-1BH22-0XA0	6ES7 221-1BF22-0XA0	6ES7 221-1EF22-0XA0
Current consumption			
•from backplane bus 5 V DC, max.	70 mA	30 mA	30 mA
•Power dissipation, typical	3 W	2 W	3 W
Connection system			
•Pluggable I/O terminals	Yes	Yes	Yes
Digital inputs			
•Number of digital inputs	16	8	8
Length of cable			
- Length of cable shielded, max	500 m	500 m	500 m
- Length of cable unshielded, max	300 m	300 m	300 m
•m/p reading	Yes	Yes	
•Input characteristic to comply with IEC 1131, Type 1	Yes		Yes
Input voltage			
- Rated value, AC			230 V; 220/230 V AC (47 to 63 Hz)
- Rated value, DC	24 V	24 V	
- for signal "0"	0 to 5 V	0 to 5 V	to 20 V AC
- for signal "1"	15 to 30 V	15 to 30 V	79 V AC (at 2.5 mA min.)
Input current			
- for 1 signal, typical	4 mA	4 mA	2.5 mA
Input delay (at rated value of the input voltage)			
•For standard inputs			
- at 0 after 1, max.	4.5 ms	4.5 ms	15 ms
Sensor			
Connectable encoders			
- 2-wire BEROS	Yes	Yes	Yes
- permissible closed-circuit current (2-wire BEROS), max.	1 mA	1 mA	1 mA
Potentials/ electrical isolation			
Digital input functions			
- Electrical isolation, digital input functions	Yes; Optocoupler	Yes; Optocoupler	Yes; Optocoupler
- between the channels, in groups of	4	4	1; (8 groups)
Dimensions and weight			
•Weight, approx.	160 g	150 g	160 g
•Width	71.2 mm	46 mm	71.2 mm
•Height	80 mm	80 mm	80 mm
•Depth	62 mm	62 mm	62 mm

Technical specifications EM 222

	6ES7 222-1BD22-0XA0	6ES7 222-1BF22-0XA0
Voltagages and currents		
Load voltage L+		
- Rated value (DC)	24 V	24 V
- permissible range, lower limit (DC)	20.4 V	20.4 V
- permissible range, upper limit (DC)	28.8 V	28.8 V
Current consumption		
Digital outputs		
•from backplane bus 5 V DC, max.	40 mA	50 mA
•Power dissipation, typical	3 W	2 W
Connection system		
•Pluggable I/O terminals	Yes	Yes
Digital outputs		
•Number of digital outputs	4	8
•Length of cable shielded, max.	500 m	500 m
•Length of cable unshielded, max.	150 m	150 m
•Short-circuit protection of the output	No; provided externally (see manual package "Installing an S7-200")	No; provided externally (see manual package "Installing an S7-200")
•Limitation of voltage induced on circuit interruption to	L+ (-48 V)	L+ (-48 V)
Output voltage		
- for 1 signal	20 V DC	20 V
Output current		
- for 1 signal permissible range for 0 to 55 °C, max.	5 A	750 mA
- for 0 signal residual current, max.	30 µA	10 µA
Parallel switching of 2 outputs		
- to increase power		Yes
Summation current of the outputs (per group)		
- up to 40 °C, max.	20 A	3 A
- horizontal installation, up to 55 °C, max.	20 A	3 A
- Maximum current per wire/group	5 A	3 A
Relay outputs		
Switching capacity of the contacts		
- at inductive load, max.	5 A	0.75 A
- at lamp load, max.	50 W	5 W
- at resistive load, max.	5 A	0.75 A
Potentials/ electrical isolation		
Digital output functions		
- Electrical isolation, digital output functions	Yes; Optocoupler	Yes; Optocoupler
- between the channels, in groups of	1; 4 groups	4
Dimensions and weight		
•Weight, approx.	120 g	150 g
•Width	45 mm	45 mm
•Height	80 mm	80 mm
•Depth	62 mm	62 mm

Technical specifications (continued)

	6ES7 222-1HD22-0XA0	6ES7 222-1HF22-0XA0	6ES7 222-1EF22-0XA0
Voltages and currents			
Load voltage L+			
- Rated value (DC)	24 V	24 V	
- permissible range, lower limit (DC)	12 V	5 V	
- permissible range, upper limit (DC)	30 V	30 V	
Load voltage L1			
- Rated value (AC)	24 V; 24 to 230 V AC	24 V; 24 to 230 V AC	230 V; 220/230 V AC
- permissible range, lower limit (AC)	12 V	5 V	65 V
- permissible range, upper limit (AC)	250 V	250 V	264 V
- permissible frequency range, lower limit		47 Hz	47 Hz
- permissible frequency range, upper limit		63 Hz	63 Hz
Current consumption			
Digital outputs			
- from load voltage L+, max.	80 mA; 20 mA per switched output	72 mA; 9 mA per switched output	
•from backplane bus 5 V DC, max.	30 mA	40 mA	110 mA
•Power dissipation, typical	4 W	2 W	4 W
Connection system			
•Pluggable I/O terminals	Yes	Yes	Yes
Digital outputs			
•Number of digital outputs	4; Relay	8; Relay	8
•Length of cable shielded, max.	500 m	500 m	500 m
•Length of cable unshielded, max.	150 m	150 m	150 m
•Short-circuit protection of the output	No; provided externally (see manual package "Installing an S7-200")	No; provided externally (see manual package "Installing an S7-200")	No; provided externally (see manual package "Installing an S7-200")
•Limitation of voltage induced on circuit interruption to	provided externally (see manual package "Installing an S7-200")	provided externally (see manual package "Installing an S7-200")	provided externally (see manual package "Installing an S7-200")
Output voltage			
- for 1 signal			L1 (-0.9 V)
Output current			
- for 1 signal permissible range for 0 to 55 °C, max.	10 A	2 A	500 mA; AC
- for 1 signal minimum load current			50 mA
- for 0 signal residual current, max.	0 mA	0 mA	1.8 mA; at 264 V AC
Summation current of the outputs (per group)			
- up to 40 °C, max.	40 mA	8 A	0.5 A
- horizontal installation, up to 55 °C, max.	20 mA	8 A	0.5 A
- Maximum current per wire/group	10 A	8 A	0.5 A
Relay outputs			
•Number of operating cycles	30,000,000; mechanical 30 million, at rated load voltage 30,000	10,000,000; mechanical 10 million, at rated load voltage 100,000	
Switching capacity of the contacts			
- at inductive load, max.	3 A; 2 A (DC), 3 A (AC)	2 A	0.5 A
- at lamp load, max.	1,000 W; 100/1000 W (DC/AC)	200 W; 30/200 W (DC/AC)	60 W
- at resistive load, max.	10 A	2 A	0.5 A

Technical specifications (continued)

	6ES7 222-1HD22-0XA0	6ES7 222-1HF22-0XA0	6ES7 222-1EF22-0XA0
Potentials/ electrical isolation			
Digital output functions			
- Electrical isolation, digital output functions	Yes; Relay	Yes; Relay	Yes; Optocoupler
- between the channels, in groups of	1; 4 groups	4	1; 8 groups
Dimensions and weight			
•Weight, approx.	150 g	170 g	170 g
•Width	45 mm	45 mm	71.2 mm
•Height	80 mm	80 mm	80 mm
•Depth	62 mm	62 mm	62 mm

Technical specifications EM 223

	6ES7 223-1BF22-0XA0	6ES7 223-1BH22-0XA0	6ES7 223-1BL22-0XA0
Voltages and currents			
Load voltage L+			
- Rated value (DC)	24 V	24 V	24 V
- permissible range, lower limit (DC)	20.4 V	20.4 V	20.4 V
- permissible range, upper limit (DC)	28.8 V	28.8 V	28.8 V
Current consumption			
•from backplane bus 5 V DC, max.	40 mA	80 mA	160 mA
•Power dissipation, typical	2 W	3 W	6 W
Connection system			
•Pluggable I/O terminals	Yes	Yes	Yes
Digital inputs			
•Number of digital inputs	4	8	16
Input voltage			
- Rated value, DC	24 V	24 V	24 V
- for signal "0"	0 to 5 V	0 to 5 V	0 to 5 V
- for signal "1"	15 to 30 V DC	15 to 30 V DC	15 to 30 V DC
Input current			
- for 1 signal, typical	4 mA	4 mA	4 mA
Input delay (at rated value of the input voltage)			
•For standard inputs			
- at 0 after 1, max.	4.5 ms	4.5 ms	4.5 ms
Digital outputs			
•Number of digital outputs	4	8	16
•Length of cable shielded, max.	500 m	500 m	500 m
•Length of cable unshielded, max.	150 m	150 m	150 m
•Short-circuit protection of the output	No; provided externally	No; provided externally	No; provided externally
•Limitation of voltage induced on circuit interruption to	L+ (-48 V)	L+ (-48 V)	L+ (-48 V)
Output voltage			
- for 0 signal (DC), max.	0.1 V	0.1 V	0.1 V
- for 1 signal	20 V	20 V	20 V
Output current			
- for 1 signal rated value	750 mA	750 mA	750 mA
Summation current of the outputs (per group)			
- Maximum current per wire/group	3 A	3 A	3 A; 3/3/6

Technical specifications (continued)

	6ES7 223-1BF22-0XA0	6ES7 223-1BH22-0XA0	6ES7 223-1BL22-0XA0
Relay outputs			
Switching capacity of the contacts			
- at inductive load, max.	0.75 A; per output	0.75 A; per output	0.75 A; per output
- at lamp load, max.	5 W	5 W	5 W
- at resistive load, max.	0.75 A; per output	0.75 A; per output	0.75 A; per output
Sensor			
Connectable encoders			
- 2-wire BEROS	Yes	Yes	Yes
- permissible closed-circuit current (2-wire BEROS), max.	1 mA	1 mA	1 mA
Insulation			
•Insulation tested with	500 V AC	500 V AC	500 V AC
Potentials/ electrical isolation			
Digital output functions			
- Electrical isolation, digital output functions	Yes; Optocoupler	Yes; Optocoupler	Yes; Optocoupler
- between the channels, in groups of	4	4	4; 4 / 4 / 8
Digital input functions			
- Electrical isolation, digital input functions	Yes; Optocoupler	Yes; Optocoupler	Yes; Optocoupler
- between the channels, in groups of	4	4	4
Dimensions and weight			
•Weight, approx.	160 g	200 g	360 g
•Width	46 mm	71.2 mm	137.5 mm
•Height	80 mm	80 mm	80 mm
•Depth	62 mm	62 mm	62 mm
Voltagages and currents			
Load voltage L+			
- Rated value (DC)	24 V	24 V	24 V
- permissible range, lower limit (DC)	5 V	5 V	5 V
- permissible range, upper limit (DC)	30 V	30 V	30 V
Load voltage L1			
- Rated value (AC)	230 V; 24 to 230 V AC	230 V; 24 to 230 V AC	230 V; 24 to 230 V AC
- permissible range, lower limit (AC)	5 V	5 V	5 V
- permissible range, upper limit (AC)	250 V	250 V	250 V
Current consumption			
•from backplane bus 5 V DC, max.	40 mA	80 mA	150 mA
•from coil current, max.	9 mA; per output for signal "1"	9 mA; per output for signal "1"	9 mA; per output for signal "1"
•from sensor current or ext. power supply (24 V DC), max.	72 mA	72 mA	72 mA
•Power dissipation, typical	2 W	3 W	6 W
Connection system			
•Pluggable I/O terminals	Yes	Yes	Yes
6ES7 223-1HF22-0XA0			
6ES7 223-1PH22-0XA0			
6ES7 223-1PL22-0XA0			

Technical specifications (continued)

	6ES7 223-1HF22-0XA0	6ES7 223-1PH22-0XA0	6ES7 223-1PL22-0XA0
Digital inputs			
•Number of digital inputs	4	8	16
Input voltage			
- Rated value, DC	24 V	24 V	24 V
- for signal "0"	0 to 5 V	0 to 5 V	0 to 5 V
- for signal "1"	15 to 30 V DC	15 to 30 V DC	15 to 30 V DC
Input current			
- for 1 signal, typical	4 mA	4 mA	4 mA
Input delay (at rated value of the input voltage)			
•For standard inputs			
- at 0 after 1, max.	4.5 ms	4.5 ms	4.5 ms
Digital outputs			
•Number of digital outputs	4; Relay	8; Relay	16; Relay
•Length of cable shielded, max.	500 m	500 m	500 m
•Length of cable unshielded, max.	150 m	150 m	150 m
•Short-circuit protection of the output	No; provided externally	No; provided externally	No; provided externally
Output voltage			
- for 0 signal (DC), max.	0.1 V; with 10 kOhm load	0.1 V; with 10 kOhm load	0.1 V; with 10 kOhm load
- for 1 signal	L+/L1	L+/L1	L+/L1
Output current			
- for 1 signal rated value	2,000 mA	2,000 mA	2,000 mA
Summation current of the outputs (per group)			
- Maximum current per wire/group	8 A	8 A	8 A
Relay outputs			
•Number of operating cycles	10,000,000; mechanical: 10 million, at rated load voltage: 100.000	10,000,000; mechanical: 10 million, at rated load voltage: 100.000	10,000,000; mechanical: 10 million, at rated load voltage: 100.000
Switching capacity of the contacts			
- at inductive load, max.	0.75 A; per output	0.75 A; per output	0.75 A; per output
- at lamp load, max.	200 W; 30/200 W (DC/AC)	200 W; 30/200 W (DC/AC)	200 W; 30/200 W (DC/AC)
- at resistive load, max.	0.75 A; per output	0.75 A; per output	0.75 A; per output
Sensor			
Connectable encoders			
- 2-wire BERS	Yes	Yes	Yes
- permissible closed-circuit current (2-wire BERS), max.	1 mA	1 mA	1 mA
Insulation			
•Insulation tested with	500 V AC	500 V AC	500 V AC
Potentials/ electrical isolation			
Digital output functions			
- Electrical isolation, digital output functions	Yes; Relay	Yes; Relay	Yes; Relay
- between the channels, in groups of	4	4	4
Digital input functions			
- Electrical isolation, digital input functions	Yes; Optocoupler	Yes; Optocoupler	Yes; Optocoupler
- between the channels, in groups of	4	4	8
Dimensions and weight			
•Weight, approx.	160 g	300 g	400 g
•Width	46 mm	71.2 mm	137.5 mm
•Height	80 mm	80 mm	80 mm
•Depth	62 mm	62 mm	62 mm

Ordering Data	Order No.	Order No.	
Digital input module EM 221 For CPU 221/222/224/224 XP/226			
<ul style="list-style-type: none"> • 8 inputs, 24 V DC, galvanically isolated, source/sink switching ^{A)} 	6ES7 221-1BF22-0XA0	Front flap set ^{A)} contains different covering flaps for CPU and EM; Spare part	6ES7 291-3AX20-0XA0
<ul style="list-style-type: none"> • 16 inputs, 24 V DC, galvanically isolated, source/sink switching ^{A)} 	6ES7 221-1BH22-0XA0	Plug-in terminal block (spare part) <ul style="list-style-type: none"> • with 7 connection terminals (for EM 221/222) ^{A)} 	6ES7 292-1AD20-0AA0
<ul style="list-style-type: none"> • 8 inputs, 120/230 V AC, galvanically isolated, source/sink switching ^{A)} 	6ES7 221-1EF22-0XA0	<ul style="list-style-type: none"> • with 12 connection terminals (for EM 223) ^{A)} 	6ES7 292-1AE20-0AA0
Digital output module EM 222 For CPU 221/222/224/224 XP/226		SIM 274 simulator (optional) ^{A)} with 8 connection terminals for EM 221 and EM 223	6ES7 274-1XF00-0XA0
<ul style="list-style-type: none"> • 4 outputs, 24 V DC; 5 A, galvanically isolated ^{A)} 	6ES7 222-1BD22-0XA0	S7-200 programmable controller, system manual for CPU 221/222/224/224 XP/226 and STEP 7-Micro/Win V4	
<ul style="list-style-type: none"> • 8 outputs, 24 V DC; 0.75 A, galvanically isolated ^{A)} 	6ES7 222-1BF22-0XA0	German	6ES7 298-8FA24-8AH0
<ul style="list-style-type: none"> • 4 outputs, 24 V DC/24 V AC up to 230 V; 10 A, galvanically isolated, relay outputs ^{A)} 	6ES7 222-1HD22-0XA0	English	6ES7 298-8FA24-8BH0
<ul style="list-style-type: none"> • 8 outputs, 24 V DC/24 V AC up to 230 V; 2 A, galvanically isolated, relay outputs ^{A)} 	6ES7 222-1HF22-0XA0	French	6ES7 298-8FA24-8CH0
<ul style="list-style-type: none"> • 8 outputs, AC 120/230 V; 0.5 A, galvanically isolated ^{A)} 	6ES7 222-1EF22-0XA0	Spanish	6ES7 298-8FA24-8DH0
<ul style="list-style-type: none"> • 8 outputs, AC 120/230 V; 0.5 A, galvanically isolated ^{A)} 	6ES7 222-1EF22-0XA0	Italian	6ES7 298-8FA24-8EH0
<ul style="list-style-type: none"> • 8 outputs, AC 120/230 V; 0.5 A, galvanically isolated ^{A)} 	6ES7 222-1EF22-0XA0	Chinese	6ES7 298-8FA24-8FH0
Digital input/output module EM 223 For CPU 221/222/224/224 XP/226			
<ul style="list-style-type: none"> • 4 inputs 24 V DC, 4 outputs 24 V DC; 0.75 A, galvanically isolated ^{A)} 	6ES7 223-1BF22-0XA0		
<ul style="list-style-type: none"> • 8 inputs 24 V DC, 8 outputs 24 V DC; 0.75 A, galvanically isolated ^{A)} 	6ES7 223-1BH22-0XA0		
<ul style="list-style-type: none"> • 16 inputs 24 V DC, 16 outputs 24 V DC; 0.75 A, galvanically isolated ^{A)} 	6ES7 223-1BL22-0XA0		
<ul style="list-style-type: none"> • 4 inputs 24 V DC, 4 outputs, relay ^{A)} 	6ES7 223-1HF22-0XA0		
<ul style="list-style-type: none"> • 8 inputs 24 V DC, 8 outputs, relay ^{A)} 	6ES7 223-1PH22-0XA0		
<ul style="list-style-type: none"> • 16 inputs 24 V DC, 16 outputs, relay ^{A)} 	6ES7 223-1PL22-0XA0		

A) Subject to export regulations: AL: N and ECCN: EAR99H

SIMATIC S7-200 SIPLUS digital modules

SIPLUS digital modules

3

Overview



- Digital inputs/outputs to supplement the integral I/Os of the CPUs
- For flexible adaptation of the controller to the task
- For subsequent upgrading of the system with additional inputs and outputs

These modules are designed for

- *an ambient range of -25 °C to $+70\text{ °C}$, condensation permissible*
- *extraordinary medial load (for example by chloric and sulphuric atmospheres)*

Technical specifications

6AG1 221-1BF22-2XB0	see 6ES7 221-1BF22-0XA0
6AG1 221-1BH22-2XA0	see 6ES7 221-1BH22-0XA0
6AG1 222-1BF22-2XB0	see 6ES7 222-1BF22-0XA0
6AG1 222-1HF22-2XB0	see 6ES7 222-1HF22-0XA0
6AG1 223-1BF22-2XB0	see 6ES7 223-1BF22-0XA0
6AG1 223-1BH22-2XB0	see 6ES7 223-1BH22-0XA0
6AG1 223-1BL22-2XB0	see 6ES7 223-1BL22-0XA0
6AG1 223-1HF22-2XB0	see 6ES7 223-1HF22-0XA0
6AG1 223-1PH22-2XB0	see 6ES7 223-1PH22-0XA0
6AG1 223-1PL22-2XB0	see 6ES7 223-1PL22-0XA0

Ordering Data

Order No.

SIPLUS EM 221 digital input module

(extended temperature range)
for CPU 222/224/224 XP/226

- 8 inputs, 24 V DC, electrically isolated, P-M switching ^{A)}
- 16 inputs, 24 V DC, electrically isolated, P-M switching ^{A)}

6AG1 221-1BF22-2XB0

6AG1 221-1BH22-2XA0

SIPLUS EM 222 digital output module

(extended temperature range)
for CPU 222/224/224 XP/226

- 8 outputs, 24 V DC; 0.75 A, electrically isolated ^{A)}
- 8 outputs, 24 V DC / 24 to 230 V AC; 2 A, electrically isolated, relay outputs ^{A)}

6AG1 222-1BF22-2XB0

6AG1 222-1HF22-2XB0

EM 223 digital input/output module

(extended temperature range)
for CPU 222/224/224 XP/226

- 4 inputs, 24 V DC, 4 outputs, 24 V DC; 0.75 A, electrically isolated ^{A)}
- 8 inputs, 24 V DC, 8 outputs, 24 V DC; 0.75 A, electrically isolated ^{A)}
- 16 inputs, 24 V DC, 16 outputs, 24 V DC; 0.75 A, electrically isolated ^{A)}
- 4 inputs, 24 V DC, 4 outputs, relays ^{A)}
- 8 inputs, 24 V DC, 8 outputs, relays ^{A)}
- 16 inputs, 24 V DC, 16 outputs, relays ^{A)}

6AG1 223-1BF22-2XB0

6AG1 223-1BH22-2XB0

6AG1 223-1BL22-2XB0

6AG1 223-1HF22-2XB0

6AG1 223-1PH22-2XB0

6AG1 223-1PL22-2XB0

Accessories

see ordering data for S7-200 digital modules

A) Subject to export regulations: AL: N and ECCN: EAR99H

Overview



- Analog inputs and outputs for the SIMATIC S7-200
- With extremely short conversion times
- For connections of analog sensors and actuators without additional amplifier
- For solving the more complex automation tasks

Technical specifications EM 231

	6ES7 231-0HC22-0XA0
Current consumption	
•from load voltage L+ (no load), max.	60 mA
•from backplane bus 5 V DC, max.	20 mA
•Power dissipation, typical	2 W
Connection system	
•Pluggable I/O terminals	No
Analog inputs	
•Number of analog inputs	4; Differential
•Length of cable shielded, max	100 m; to sensor
•Permissible input voltage for the voltage input (destruction limit), max.	30 V
•Permissible input voltage for the current input (destruction limit), max.	32 mA
Input ranges (rated values), voltages	
- 0 to +5 V	Yes
- 0 to +10 V	Yes
- -2.5 V to +2.5 V	Yes
- -5 V to +5 V	Yes
Input ranges (rated values), currents	
- 0 to 20 mA	Yes
Characteristic curve linearization	
- for voltage measurement	no
- for current measurement	no
Temperature compensation	
- parameterizable	No

	6ES7 231-0HC22-0XA0
Analog value formation	
Integration and conversion time/triggering per channel	
- with over-range (bits incl. sign), max	12 Bit
- Interference voltage suppression for interference frequency f1 in Hz	40 dB, DC up to 60 V for interference frequency 50 / 60 Hz
- Conversion time (per channel)	250 µs
Displayable conversion value range	
- bipolar signals	-32,000 to +32,000
- unipolar signals	0 to 32000
Error/accuracies	
Interference voltage suppression for $f = n \times (f1 \pm 1\%)$	
- Common-mode voltage, max.	12 V
Potentials/ electrical isolation	
Analog output functions	
- Electrical isolation, analog inputs	No
Dimensions and weight	
•Weight, approx.	183 g
•Width	71.2 mm
•Height	80 mm
•Depth	62 mm

Technical specifications EM 232

6ES7 232-0HB22-0XA0	
Current consumption	
•from backplane bus 5 V DC, max.	20 mA
•from sensor current or ext. power supply (24 V DC), max.	70 mA
•Power dissipation, typical	2 W
Connection system	
•Pluggable I/O terminals	No
Analog outputs	
•Number of analog outputs	2
Output ranges, voltage	
- -10 to +10 V	Yes
Output ranges, current	
- 4 to 20 mA	Yes
Burden resistance (in the nominal output range)	
- at voltage outputs, min.	5 k Ω
- at current outputs, max.	0.5 k Ω
Analog value formation	
Integration and conversion time/triggering per channel	
- with over-range	U/12 bits, I/11 bits
Settling time	
- for voltage output function	100 μ s
- for current output function	2 ms
Displayable conversion value range	
- bipolar signals	-32,000 to +32,000
- unipolar signals	0 to 32,000
Error/accuracies	
Operational limit in the entire temperature range	
- Relative to the output range, voltage	+/- 2 %
- Relative to the output range, current	+/- 2 %
Basic error limit (operational limit at 25 °C)	
- relative to the output range, voltage	+/- 0.5 %
- relative to the output range, current	+/- 0.5 %
Potentials/ electrical isolation	
Analog output functions	
- Electrical isolation, analog output functions	No
Dimensions and weight	
•Weight, approx.	148 g
•Width	46 mm
•Height	80 mm
•Depth	62 mm

Technical specifications EM 235

6ES7 235-0KD22-0XA0	
Current consumption	
•from backplane bus 5 V DC, max.	30 mA
•from sensor current or ext. power supply (24 V DC), max.	60 mA
•Power dissipation, typical	2 W
Connection system	
•Pluggable I/O terminals	No
Analog inputs	
•Number of analog inputs	4; Differential
•Permissible input voltage for the voltage input (destruction limit), max.	30 V
•Permissible input voltage for the current input (destruction limit), max.	32 mA
Input ranges (rated values), voltages	
- Voltage	Yes
- 0 to +50 mV	Yes
- 0 to +100 mV	Yes
- 0 to +500 mV	Yes
- 0 to +1 V	Yes
- 0 to +5 V	Yes
- 0 to +10 V	Yes
- -1 V to +1 V	Yes
- -10 V to +10 V	Yes
- -100 mV to +100 mV	Yes
- -2.5 V to +2.5 V	Yes
- -25 mV to +25 mV	Yes
- -250 mV to +250 mV	Yes
- -5 V to +5 V	Yes
- -50 mV to +50 mV	Yes
- -500 mV to +500 mV	Yes
Input ranges (rated values), currents	
- Current	Yes
- 0 to 20 mA	Yes
Characteristic curve linearization	
- for voltage measurement	No
- for current measurement	No
Temperature compensation	
- parameterizable	No
Analog outputs	
•Number of analog outputs	1
Output ranges, voltage	
- -10 to +10 V	Yes
Output ranges, current	
- 0 to 20 mA	Yes
Burden resistance (in the nominal output range)	
- at voltage outputs, min.	5 k Ω
- at current outputs, max.	0.5 k Ω

Technical specifications (continued)

	6ES7 235-0KD22-0XA0
Analog value formation	
Integration and conversion time/triggering per channel	
- with over-range (bits incl. sign), max	12 Bit; 11 bits for power output
- Basic conversion time, ms	< 0.25 ms
- Interference voltage suppression for interference frequency f1 in Hz	40 dB, DC to 60 Hz
Settling time	
- for voltage output function	100 µs
- for current output function	2 ms
Displayable conversion value range	
- bipolar signals	-32,000 to +32,000
- unipolar signals	0 to 32,000
Error/accuracies	
Operational limit in the entire temperature range	
- Relative to the output range, voltage	+/- 2 %
- Relative to the output range, current	+/- 2 %
Basic error limit (operational limit at 25 °C)	
- relative to the output range, voltage	+/- 0.5 %
- relative to the output range, current	+/- 0.5 %
Interference voltage suppression for f = n x (fl +/- 1 %)	
- Common-mode voltage, max.	12 V
Potentials/ electrical isolation	
Analog output functions	
- Electrical isolation, analog output functions	No
Analog input functions	
- Electrical isolation, analog inputs	No
Dimensions and weight	
•Weight, approx.	186 g
•Width	71.2 mm
•Height	80 mm
•Depth	62 mm

Ordering Data

Order No.

EM 231 analog input module ^{A)}	6ES7 231-0HC22-0XA0
for CPU 222/224/224 XP/226; 4 inputs, 0 - 10 V, 12-bit resolution	
EM 232 analog output module ^{A)}	6ES7 232-0HB22-0XA0
for CPU 222/224/224 XP/226; 2 outputs, ± 10 V, 12-bit resolution	
EM 235 analog input/output ^{A)}	6ES7 235-0KD22-0XA0
for CPU 222/224/224 XP/226; 4 inputs, 1 output, ±10 V DC, 12-bit resolution	
Grounding terminal	6ES5 728-8MA11
10 items	
Front flap set ^{A)}	6ES7 291-3AX20-0XA0
contains different covering flaps for CPU and EM; Spare part	
S7-200 programmable controller, system manual	
for CPU 221/222/224/224 XP/226 and STEP 7-Micro/Win V4	
German	6ES7 298-8FA24-8AH0
English	6ES7 298-8FA24-8BH0
French	6ES7 298-8FA24-8CH0
Spanish	6ES7 298-8FA24-8DH0
Italian	6ES7 298-8FA24-8EH0
Chinese	6ES7 298-8FA24-8FH0

A) Subject to export regulations: AL: N and ECCN: EAR99H

Overview



- For user-friendly, high precision temperature detection
- 7 standard types of thermocouple can be used
- For measuring low-level analog signals (± 80 mV), as well
- Easy to install in an existing system

Technical specifications

	6ES7 231-7PD22-0XA0
Current consumption	
• from load voltage L+ (no load), max.	60 mA
• from backplane bus 5 V DC, max.	87 mA
• Power dissipation, typical	1.8 W
Connection system	
• Pluggable I/O terminals	No
Analog inputs	
• Number of analog inputs	4
• Length of cable shielded, max	100 m; to sensor
• Permissible input voltage for the voltage input (destruction limit), max.	30 V
• Loop resistance line	100 Ω
• Update time (all channels)	405 ms
Input ranges (rated values), voltages	
- -80 mV to +80 mV	Yes
Input ranges (rated values), thermocouples	
- Type E	Yes
- Type J	Yes
- Type K	Yes
- Type N	Yes
- Type R	Yes
- Type S	Yes
- Type T	Yes

	6ES7 231-7PD22-0XA0
Analog value formation	
• Measuring principle	Sigma-Delta
Integration and conversion time/triggering per channel	
- with over-range (bits incl. sign), max	16 Bit; Temperature 0.1 $^{\circ}\text{C}$ / 0.1 $^{\circ}\text{F}$
- Interference voltage suppression for interference frequency f1 in Hz	85 dB at 50 / 60 / 400 Hz
Displayable conversion value range	
- bipolar signals	-27,648 to +27,648
Error/accuracies	
• Cold connection point	+/-1.5 $^{\circ}\text{C}$
• Repeatability in the settled state at 25 $^{\circ}\text{C}$ (relative to the output range)	+/- 0.05 %
Operational limit in the entire temperature range	
- Relative to the output range, voltage	+/- 0.1 %
Interference voltage suppression for f = n x (f1 +/- 1 %)	
- Common-mode voltage, max.	120 V; AC
- Common-mode interference, min	120 dB; at 120 V AC
Potentials/ electrical isolation	
Analogue output functions	
- Electrical isolation, analogue inputs	Yes
Dimensions and weight	
• Weight, approx.	210 g
• Width	71.2 mm
• Height	80 mm
• Depth	62 mm

Ordering Data	Order No.	Order No.
EM 231 thermocouple module ^{A)} 4 inputs +/- 80 mV, 15-bit resolution + sign, thermocouples type J, K, S, T, R, E, N	6ES7 231-7PD22-0XA0	S7-200 programmable controller, system manual for CPU 221/222/224/224 XP/226 and STEP 7-Micro/Win V4 German English French Spanish Italian Chinese
Grounding terminal 10 items	6ES5 728-8MA11	
Backplane bus expansion cable ^{A)} for connecting the two equipment tiers in a two-tier configuration, for CUP 222/224/224 XP/226	6ES7 290-6AA20-0XA0	

6ES7 298-8FA24-8AH0
6ES7 298-8FA24-8BH0
6ES7 298-8FA24-8CH0
6ES7 298-8FA24-8DH0
6ES7 298-8FA24-8EH0
6ES7 298-8FA24-8FH0

A) Subject to export regulations: AL: N and ECCN: EAR99H

Overview



- For user-friendly, high precision temperature detection
- Supports 31 standard resistance temperature sensors
- Easy to install in an existing system

Technical specifications

	6ES7 231-7PB22-0XA0
Current consumption	
•from load voltage L+ (no load), max.	60 mA
•from backplane bus 5 V DC, max.	87 mA
•Power dissipation, typical	1.8 W; Sensor: 1 mW
Connection system	
•Pluggable I/O terminals	No
Analog inputs	
•Number of analog inputs	2
•Length of cable shielded, max	100 m; to sensor
•Permissible input voltage for the voltage input (destruction limit), max.	30 V; 30 V DC (sensor), 5 V DC (source)
•Loop resistance line	20 Ω; max. 2.7 ohms for Cu
•Update time (all channels)	405 ms; 700 ms at Pt 10000
Input ranges (rated values), resistances	
- 0 to 150 ohms	Yes
- 0 to 300 ohms	Yes
- 0 to 600 ohms	Yes
Input ranges (rated values), resistance thermometer	
- Cu 10	Yes
- Ni 10	Yes
- Ni 1000	Yes
- Ni 120	Yes
- Pt 100	Yes
- Pt 1000	Yes
- Pt 10000	Yes
- Pt 200	Yes
- Pt 500	Yes

	6ES7 231-7PB22-0XA0
Analog value formation	
•Measuring principle	Sigma-Delta
Integration and conversion time/triggering per channel	
- with over-range (bits incl. sign), max	16 Bit; Temperature 0.1 °C / 0.1 °F
- Interference voltage suppression for interference frequency f1 in Hz	85 dB at 50 / 60 / 400 Hz
Displayable conversion value range	
- bipolar signals	-27,648 to +27,648
Error/accuracies	
•Repeatability in the settled state at 25°C (relative to the output range)	+/- 0.05 %
Operational limit in the entire temperature range	
- Relative to the output range, voltage	+/- 0.1 %
Interference voltage suppression for f = n x (fl +/- 1 %)	
- Common-mode voltage, max.	0 V
- Common-mode interference, min	120 dB; at 120 V AC
Potentials/ electrical isolation	
Analogue output functions	
- Electrical isolation, analogue inputs	Yes
Dimensions and weight	
•Weight, approx.	210 g
•Width	71.2 mm
•Height	80 mm
•Depth	62 mm

Ordering Data	Order No.	Order No.
EM 231 RTD module ^{A)} 2 inputs for thermistors Pt100/200/500/1000/10000, Ni100/120/1000, Cu10; resistance 150/300/600 Ohms, 15-bit resolution + sign	6ES7 231-7PB22-0XA0	S7-200 programmable controller, system manual for CPU 221/222/224/224 XP/226 and STEP 7-Micro/Win V4 German English French Spanish Italian Chinese
Grounding terminal 10 items	6ES5 728-8MA11	
Backplane bus expansion cable ^{A)} for connecting the two equipment tiers in a two-tier configuration, for CUP 222/224/224 XP/226	6ES7 290-6AA20-0XA0	
		6ES7 298-8FA24-8AH0 6ES7 298-8FA24-8BH0 6ES7 298-8FA24-8CH0 6ES7 298-8FA24-8DH0 6ES7 298-8FA24-8EH0 6ES7 298-8FA24-8FH0

A) Subject to export regulations: AL: N and ECCN: EAR99H

SIMATIC S7-200 SIPLUS analog modules

SIPLUS analog modules

3

Overview



- Analog inputs and outputs for the SIMATIC S7-200
- With extremely short conversion times
- For connections of analog sensors and actuators without additional amplifier
- For solving the more complex automation tasks

These modules are designed for

- *an ambient range of -25 °C to $+70\text{ °C}$, condensation permissible*
- *extraordinary medial load (for example by chloric and sulphuric atmospheres)*

Technical specifications

6AG1 231-0HC22-2XB0	see 6ES7 231-0HC22-0XA0
6AG1 232-0HB22-2XB0	see 6ES7 232-0HB22-0XA0
6AG1 235-0KD22-2XB0	see 6ES7 235-0KD22-0XA0

Ordering Data

Order No.

SIPLUS EM 231 analog input module ^{A)}	6AG1 231-0HC22-2XB0
--	----------------------------

(extended temperature range)
for CPU 222/224/224 XP/226;
4 inputs, 0-10 V, resolution 12 bit

SIPLUS EM 232 analog output module ^{A)}	6AG1 232-0HB22-2XB0
---	----------------------------

(extended temperature range)
for CPU 222/224/224 XP/226;
2 outputs, $\pm 10\text{ V}$, resolution 12 bit

SIPLUS EM 235 analog input/output module ^{A)}	6AG1 235-0KD22-2XB0
---	----------------------------

(extended temperature range)
for CPU 222/224/224 XP/226;
4 inputs, 1 output, $\pm 10\text{ V DC}$,
resolution 12 bit

Accessories

siehe Ordering Data for S7-200 analog modules

A) Subject to export regulations: AL: N and ECCN: EAR99H

Overview



- Function modules for simple positioning tasks (1 axis)
- Stepper motors and servo motors from the Micro Stepper to the high-performance servo drive can be connected
- Flexible connection possibilities
- Full support from STEP 7-Micro/WIN with parameterization and startup

Technical specifications

	6ES7 253-1AA22-0XA0
Supply voltages	
Rated value	
- permissible range, lower limit (DC)	11 V
- permissible range, upper limit (DC)	30 V
Current consumption	
•from backplane bus 5 V DC, max.	190 mA
•from supply voltage L+, max.	300 mA; from 12 V DC, 130 mA from 24 V DC
Configuration	
•Number of modules per CPU	max. 5 with CPU 226/226XM, max. 3 with CPU 224, max. 1 with CPU 222
Digital inputs	
•Number of digital inputs	5
•Functions	Stop (STP), reference point switch (RPS), upper limit switch (LMT+), lower limit switch (LMT-), zero point (ZP)
Length of cable	
- Length of cable shielded, max	100 m; STP, RPS, LMT+, LMT- 100 m, ZP 10 m
- Length of cable unshielded, max	30 m; STP, RPS, LMT+, LMT- 30 m, ZP not advisable
•Type	IEC Type 1, p-reading
Input voltage	
- Rated value, DC	24 V
- for signal "0"	STP, RPS, LMT+, LMT- DC 5 V; ZP DC 1 V
- for signal "1"	STP, RPS, LMT+, LMT- DC 15 V; ZP DC 3 V
Input delay (at rated value of the input voltage)	
•For standard inputs	
- Parameterizable	Yes; STP, RPS, LMT+, LMT- 0.2 to 12.8 ms ZP min 2 μ s

Sensor	
Connectable encoders	
- 2-wire BEROs	Yes
- permissible closed-circuit current (2-wire BEROs), max.	1 mA
Drive interface	
Signal output I	
- Number	4; choice of RS422/RS485 or 5 V DC
- Type	RS422/RS485 electrically isolated (P0+, P0-, P1+, P1-)
- Differential output voltage, min.	2.8 V; RL=200 ohms
- Pulse frequency	200 kHz; P0+, P0-, P1+, P1-, P0, P1
- Length of cable, max.	10 m; 10 m shielded; 1 m unshielded
Signal output III	
- Type	5 V DC isolated (P0, P1, DIS, CLR)
- Output voltage	30 V DC
- Output current	50 mA; output delay (DIS, CLR) max. 30 μ s
Potentials/ electrical isolation	
Digital input functions	
- between the channels	Yes
- between the channels, in groups of	1 (STP, RPS, ZP), 2 (LMT-, LMT+)
Dimensions and weight	
•Weight, approx.	190 g
•Width	71.2 mm
•Height	80 mm
•Depth	62 mm

SIMATIC S7-200

Function modules

EM 253 positioning module

3

Ordering Data

EM 253 positioning module ^{A)}

for activating stepper motors or servo drives

Order No.

6ES7 253-1AA22-0XA0

Grounding terminal

10 items

6ES5 728-8MA11

Backplane bus expansion cable ^{A)}

for connecting the two equipment tiers in a two-tier configuration, for CUP 222/224/224 XP/226

6ES7 290-6AA20-0XA0

A) Subject to export regulations: AL: N and ECCN: EAR99H

S7-200 programmable controller, system manual

for CPU 221/222/224/224 XP/226 and STEP 7-Micro/Win V4

German

English

French

Spanish

Italian

Chinese

Order No.

6ES7 298-8FA24-8AH0

6ES7 298-8FA24-8BH0

6ES7 298-8FA24-8CH0

6ES7 298-8FA24-8DH0

6ES7 298-8FA24-8EH0

6ES7 298-8FA24-8FH0

Overview



- Modem expansion module for SIMATIC S7-200
- The Plug&Play solution for a ll classical modem tasks in the PLC field
- Used for remote maintenance/ remote diagnostics, CPU-to-CPU/PC communication or SMS/pager messaging
- Minimal engineering outlay required
- Replaces external modems connected via the communications interface of the CPU
- Easy to retrofit

Technical specifications

	6ES7 241-1AA22-0XA0
Voltages and currents	
Load voltage L+	
- Rated value (DC)	24 V
- permissible range, lower limit (DC)	20.4 V
- permissible range, upper limit (DC)	28.8 V
Current consumption	
•from load voltage L+ (no load), max.	70 mA
•from backplane bus 5 V DC, max.	80 mA; from expansion bus
•Power dissipation, typical	2.1 W
Communication functions	
•Bus protocol/transfer protocol	PPI, Modbus
Connection system	
•Phone lines	RJ11 (4 cables, 6 contacts)
Modem	
•Standards	Bell 103, Bell 212, V. 21, V. 22, V. 22 bis, V. 23c, V. 32, V. 32 bis, V. 34 (preset)
•Tone dialing	Yes
•Pulse dialing	Yes
Dimensions and weight	
•Weight, approx.	190 g
•Width	71.2 mm
•Height	80 mm
•Depth	62 mm

Ordering Data

Ordering Data	Order No.
EM 241 modem^{A)} Analog modem for remote maintenance/remote diagnostics; CPU-to-CPU/PC communication, SMS/pager messaging	6ES7 241-1AA22-0XA0
Grounding terminal 10 items	6ES5 728-8MA11
S7-200 programmable controller, system manual for CPU 221/222/224/224 XP/226 and STEP 7-Micro/Win V4	
German	6ES7 298-8FA24-8AH0
English	6ES7 298-8FA24-8BH0
French	6ES7 298-8FA24-8CH0
Spanish	6ES7 298-8FA24-8DH0
Italian	6ES7 298-8FA24-8EH0
Chinese	6ES7 298-8FA24-8FH0

A) Subject to export regulations: AL: N and ECCN: EAR99H

SIMATIC S7-200

Communication

EM 277 PROFIBUS DP module

3

Overview



- For connection of the S7-22x to PROFIBUS DP (as slave) and MPI
- Can be simultaneously operated as MPI slave and DP slave
- Transmission rate max. 12 Mbps
- Can be used with CPU from version 6ES7 22x-xxx 21-xxxx

Technical specifications

	6ES7 277-0AA22-0XA0
Voltages and currents	
Load voltage L+	
- Rated value (DC)	24 V
- permissible range, lower limit (DC)	20.4 V
- permissible range, upper limit (DC)	28.8 V
Current consumption	
•from backplane bus 5 V DC, max.	150 mA
•from sensor current or ext. power supply (24 V DC), max.	180 mA; 30 to 180 mA
•Power dissipation, typical	2.5 W
Configuration	
•Connectable stations	TD 200 from V2.0, OP, TP, PG/PC, S7-300/400, PROFIBUS DP-Master
Communication functions	
•Bus protocol/transfer protocol	PROFIBUS DP (Slave), MPI (Slave)
Number of connections	
- MPI connections, max.	6
- MPI connections reserved for OP communication	1
- MPI connections reserved for PG communication	1
Interfaces	
•Number of RS485 interfaces	1
5 V DC	
- Output current, max.	90 mA
24 V DC	
- Voltage range	20.4 to 28.8 V
- Output current, max.	120 mA
- Current limiting	0.7 to 2.4 A

	6ES7 277-0AA22-0XA0
Connection system	
•Pluggable I/O terminals	No
PROFIBUS DP	
•Transmission rate, max.	12 Mbit/s; 9.6 / 19.2 / 45.45 / 93.75 / 187.5 / 500 kbit/s 1 / 1.5 / 3 / 6 / 12 Mbit/s
•Station addresses	0 to 99, adjustable
•Length of cable, max.	1,200 m; 100 to 1200 m, depending on the transmission rate
•Number of stations in the system, max.	126; of which max. 99 EM 277
•Number of stations per segment, max.	32
•Automatic transmission speed detection	Yes
Dimensions and weight	
•Weight, approx.	175 g
•Width	71.2 mm
•Height	80 mm
•Depth	62 mm

Ordering Data

	Order No.
PROFIBUS DP EM 277 input module^{A)}	6ES7 277-0AA22-0XA0
for CPU 222/224/224 XP/226, for connecting to PROFIBUS DP (slave) and MPI	

	Order No.
SIPLUS PROFIBUS DP EM 277 input module (extended temperature range)	6AG1 277-0AA22-2XA0
for CPU 222/224/224 XP/226, for connecting to PROFIBUS DP (slave) and MPI	

A) Subject to export regulations: AL: N and ECCN: EAR99H

Overview



The CP 243-2 is the AS-Interface master for the innovated generation of SIMATIC S7-200. The communications processor (6GK1 243-2AX01-0AX0) supports the extended AS-Interface specification V2.1 and has the following functions:

- Up to 62 AS-Interface slaves can be connected and integrated analog value transfer (according to the extended AS-Interface specification V2.1)
- Supports all AS-Interface master functions in accordance with the extended AS-Interface specification V2.1
- Status displays for operating states and display of the functional readiness of connected slaves with LEDs in the front panel
- Indication of errors (incl. AS-Interface voltage errors, configuration errors) with LEDs in the front panel
- Compact enclosure designed to match the new generation of SIMATIC S7-200.

Technical specifications

AS-Interface specification	V 2.1
Interfaces	
• Address space used in the PLC	Corresponding to 2 I/O modules (8 DI/8 DO and 8 AI/8 AO)
• AS-Interface connection	Terminal
Current consumption	
• Via AS-Interface	Max. 100 mA
• Through backplane bus	Typ. 220 mA at DC 5 V
Power loss	Approx. 2 W
Perm. environmental conditions	
• Operating temperature	
- Horizontal mounting	0 °C to +55 °C
- Vertical mounting	0 °C to +45 °C
• Transport/storage temperature	- 40 °C to +70 °C
• Relative humidity	Max. 95% at +25 °C
Design	
• Module format	S7-22x expansion module
• Dimensions (W x H x D) in mm	71.2 x 80 x 62 (H+16 mm with holes for wall mounting)
• Weight	Approx. 250 g
• Space required	1 slot

Ordering Data

Order No.

CP 243-2 communications processor^{A)}

6GK7 243-2AX01-0XA0

For connection of SIMATIC S7-200 (2nd generation) to AS-Interface with bus connector

Manual for CP 243-2

Including AS-Interface fundamentals and diskette with program examples
paper version

• German	6GK7 243-2AX00-8AA0
• English	6GK7 243-2AX00-8BA0
• French	6GK7 243-2AX00-8CA0
• Spanish	6GK7 243-2AX00-8DA0
• Italian	6GK7 243-2AX00-8EA0

A) Subject to export regulations: AL: N and ECCN: EAR99H

SIMATIC S7-200

Communication

CP 243-1

3

Overview



- Connection of SIMATIC S7-200 to Industrial Ethernet with
 - 10/100 Mbit/s
 - Half/full duplex
 - RJ 45 socket
 - TCP/IP
- Configuration, remote programming and service is possible with STEP 7-Micro/WIN through Industrial Ethernet (program upload and download, status)
- CPU/CPU communication is possible through Industrial Ethernet (Client + Server, 8 S7 connections + 1 PG connection)
- Thanks to integration in S7-OPC, further processing of PLC data in PC applications is possible
- Modules can be replaced without the need for a programming device

Technical specifications

Data transmission rate	10/100 Mbit/s autosensing
Interfaces	
• 10 BaseT, 100 Base TX	RJ45
• Connection for power supply	24 V DC (± 5%)
Current consumption	
• From backplane bus	55 mA
• From external 24 V DC	60 mA
Power loss at 24 V DC	1.75 W
Perm. environmental conditions	
• Operating temperature	
- Horizontal mounting	0°C to +55°C
- Vertical mounting	0°C to +45°C
• Transport/storage temperature	-40 °C to +70 °C
• Relative humidity	Max. 95% at +25 °C
Design	
• Dimensions (W x H x D) in mm	71.2 x 80 x 62
• Weight	150 g
Performance data	
S7 communication/ PG communication	
• Number of usable connections	8 S7 connections + 1 PG connection
Configuration	With STEP 7-Micro/WIN (V3.2 SP1 and higher)

Ordering Data

Order No.

CP 243-1 communications processor^{D)}

6GK7 243-1EX00-0XE0

for connection of SIMATIC S7-200 to Industrial Ethernet; for S7 communication, PG communication with electronic manual on CD-ROM, German, English, French, Italian, Spanish

Programming software STEP 7-Micro/WIN32 V3.2 for SP3 and higher

Target system:

All CPUs of the SIMATIC S7-200

Prerequisite:

Windows 95/98/NT/2000/XP on PG or PC with 80486 or Pentium processor

delivery package:

German, English, French, Spanish, Italian; with online documentation

Single license^{B)}

6ES7 810-2CC03-0YX0

Single license Upgrade^{1) B)}

6ES7 810-2CC03-0YX3

1) Upgrade for all previous STEP 7-Micro/WIN and STEP 7-Micro/DOS versions

B) Subject to export regulations: AL: N and ECCN: EAR99S

D) Subject to export regulations: AL: N and ECCN: 5D992B1

Overview



- Connection of SIMATIC S7-200 to Industrial Ethernet with
 - 10/100 Mbit/s
 - Half/full duplex
 - RJ45 socket
 - TCP/IP
- Configuration, remote programming and service is possible with STEP 7-Micro/WIN through Industrial Ethernet (program upload and download, status)
- CPU/CPU communication is possible through Industrial Ethernet (Client + Server, 8 S7 connections + 1 PG connection)
- IT communication
 - Web function
 - E-mail function
 - FTP Client function for program-controlled data exchange (e.g. DOS, UNIX, LINUX, embedded systems)
- FTP server with 8 Mbyte memory
- OPC enables further processing of PLC data in PC applications

Technical specifications

Data transmission rate	10/100 Mbit/s autosensing
Interfaces	
• 10BaseT, 100BaseTX	RJ45
• Connection for power supply	24 V DC (± 5%)
Current consumption	
• From backplane bus	55 mA
• From external 24 V DC	60 mA
Power loss at 24 V DC	1.75 W
Perm. environmental conditions	
• Operating temperature	
- Horizontal mounting	0°C to +55°C
- Vertical mounting	0°C to +45°C
• Transport/storage temperature	-40 °C to +70 °C
• Relative humidity	Max. 95% at +25 °C
Design	
• Dimensions (W x H x D) in mm	71.2 x 80 x 62
• Weight	150 g
Performance data	
IT communication	
• Number of connections to an e-mail server	1
• E-mail client	32 E-mails with max. 1024 characters
• Number of FTP connections	1
• Number of HTTP connections	4
• Adjustable access enable program	8 users
• Memory capacity of the Flash Memory file system	8 MB
• Service life of the Flash Memory cells	1,000,000 write cycles
S7 communication/ PG communication	
• Number of usable connections	8 S7 connections + 1 PG connection
Configuration	With STEP 7-Micro/WIN, V3.2 SP3 and higher

Ordering Data

Order No.

CP 243-1 IT communications processor^{D)} **6GK7 243-1GX00-0XE0**

for connection of SIMATIC S7-200 to Industrial Ethernet; for S7 communication, PG communication E-mail and WWW server; with electronic manual on CD-ROM
German, English, French, Italian, Spanish

Programming software STEP 7-Micro/WIN32 V3.2 for SP3 and higher

Target system:

All CPUs of the SIMATIC S7-200

Prerequisite:

Windows 95/98/NT/2000/XP on PG or PC with 80486 or Pentium processor

Delivery package:

German, English, French, Spanish, Italian; with online documentation

Single license^{B)}

6ES7 810-2CC03-0YX0

Single license Upgrade^{1) B)}

6ES7 810-2CC03-0YX3

1) Upgrade for all previous STEP 7-Micro/WIN and STEP 7-Micro/DOS versions

B) Subject to export regulations: AL: N and ECCN: EAR99S

D) Subject to export regulations: AL: N and ECCN: 5D992B1

Overview



The regulated load power supply for the SIMATIC S7-200.

- Coordinated design and functionality, can be integrated easily into the PLC network.
- For reliably powering the controller, encoders and sensors with 24 V DC, 3.5 A.
- Flexible implementation, either in industry or in the domestic supply system

Technical specifications

Type	3.5 A
Order No.	6EP1 332-1SH31
Input	Single-phase AC
Rated voltage $V_{in \text{ rated}}$	120/230 V AC Settable using wire jumper
Voltage range	93 to 132 V/187 to 264 V AC
Overvoltage strength	$2.3 \times V_{in \text{ rated}}$; 1.3 ms
Mains buffering $I_{out \text{ rated}}$	> 20 ms at $V_{in} = 187 \text{ V}$
Rated line frequency; range	50/60 Hz, 47 to 63 Hz
Rated current $I_{in \text{ rated}}$	1.65/0.95 A
Inrush current limitation (+25 °C)	< 33 A, < 3 ms ($V_{in} = 230 \text{ V}$)
i^2t	< 1.0 A ² s
Integrated line-side fuse	T 2.5 A/250 V (not accessible)
Recommended circuit-breaker (EC 898) in mains supply line	Two-pole circuit-breaker from 10 A, Characteristic C or from 6 A, Characteristic D
Output	Stabilized, floating direct voltage
Rated voltage $V_{out \text{ rated}}$	24 V DC
Total tolerance	$\pm 5 \%$ (typ. $\pm 2 \%$)
•Stat. mains compensation	Approx. $\pm 0.1 \%$
•Stat. load compensation	Approx. $\pm 0.2 \%$
Residual ripple (clock frequency: approx. 50 kHz)	< 150 mV _{pp} (typ. 30 mV _{pp})
Spikes (bandwidth: 20 MHz)	< 240 mV _{pp} (typ. 110 mV _{pp})
Setting range	-
Status display	-
Power ON/OFF behavior	No overshoot of V_{out} (soft start)
Starting delay/voltage rise	< 1 s/typ. 80 ms
Rated current $I_{out \text{ rated}}$	3.5 A
Current range	
•Up to +45 °C	0 to 3.5 A
•Up to +60 °C	0 to 3.5 A
Dyn. V/I with	
•Starting on short circuit	typ. 5 A for 100 ms
•Short-circuit in operation	typ. 5 A for 100 ms
Parallel connection for increased output	Yes, up to 5

Type	3.5 A
Order No.	6EP1 332-1SH31
Efficiency	
Efficiency at $V_{out \text{ rated}}$, $I_{out \text{ rated}}$	Approx. 84 %
Power loss at $V_{out \text{ rated}}$, $I_{out \text{ rated}}$	Approx. 16 W
Control	
Dyn. mains compensation ($V_{in \text{ rated}} \pm 15 \%$)	$\pm 0.3 \%$ V_{out}
Dyn. load compensation (I_{out} : 50/100/50 %)	< $\pm 10 \%$ V_{out} (typ. $\pm 3 \%$ V_{out})
Settling time	
•Load step from 50 to 100%	< 5 ms
•Load step from 100 to 50%	< 5 ms
Protection and monitoring	
Output overvoltage protection	
Current limitation	3.8 A
Short-circuit protection	Stabilized current characteristic to typ. 14 V, electronic shutdown below that, automatic restart
RMS sustained short-circuit current	< 4 A
Overload/short-circuit indicator	-
Safety	
Galvanic isolation primary/secondary	Yes, SELV output voltage V_{out} acc. to EN 60950
Protective class	Class I
Discharge current	< 3.5 mA
TÜV test	Yes
CE-marking	Yes
UL/cUL (CSA), approval	Yes, cULus listed (UL 508, CSA 22.2 No. 14-M91), File E143289
FM approval	-
Appr. for use in marine vessels	-
Degree of protection (EN 60529)	IP20

Technical specifications (Continued)

Type	3.5 A
Order No.	6EP1 332-1SH31
EMC	
Interference emission	EN 55022 Class B
Line harmonics limitation	EN 61000-3-2
Interference immunity	EN 61000-6-2
Operating specifications	
Ambient temperature range	0 to +60°C with natural convection
Transportation and storage temperature range	-25 to +85 °C
Humidity rating	Climatic class 3K3 acc. to EN 60721, no condensation
Mechanical specifications	
Connections	
•Mains input L, N, PE	One screw-type terminal each for 0.5 to 1 mm ² finely stranded, 0.5 to 1.5 mm ² single-core
•Output L+	1 screw-type terminal for 0.5 to 1 mm ²
•Output M	2 screw-type terminals for 0.5 to 1 mm ²
Dimensions (W x H x D) in mm	160 x 80 x 62
Weight approx.	0.5 kg
Mounting	Snap-mounting on DIN rail EN 50022-35x15/7.5, wall mounting
Accessories	Mounting bracket

Ordering Data

Order No.

**Stabilized load power supply
SITOP power 3.5 A^{A)}**
120/230 V AC, 24 V/3.5 A DC

6EP1 332-1SH31

Mounting bracket

for space-saving installation of power supply on the cabinet rear panel (the power supply is mounted with the side wall on the rear panel of the housing); for switchgear cabinets with a depth of 240 mm or more

6EP1 971-1AA01

A) Subject to export regulations: AL: N and ECCN: EAR99H

SIMATIC S7-200

Human Machine Interface

TD 200 text display

3

Overview



- The user-friendly text display for the S7-200
- For control and monitoring:
Message text display, intervention in PLC program, setting of inputs and outputs
- Direct connection to CPU interface using supplied cable or incorporation into network (also via EM 277)
- No separate power supply required
- No separate parameterization software required
- Addressing and setting of contrast in supplied menu

Ordering Data

Order No.

Text Display TD 200

for connecting to SIMATIC S7-200; used with STEP 7 Micro/WIN V3.2 SP4 and higher.

6ES7 272-0AA30-0YA0

PROFIBUS bus connector IP20 with 90° cable feeder

- without PG connection
- with PG connection

6ES7 972-0BA12-0XA0

6ES7 972-0BB12-0XA0

PROFIBUS bus connector IP20 with 35° cable feeder

- without PG connection
- with PG connection

6ES7 972-0BA41-0XA0

6ES7 972-0BB41-0XA0

PROFIBUS FC Standard Cable

for connecting to PPI; standard type with special design for quick mounting, 2-wire, shielded, sold by the meter, up to 1000 m, minimum order 20 m

6XV1 830-0EH10

Technical specifications

6ES7 272-0AA30-0YA0	
Power supply	
Input voltage	24 V; Power supplied through the S7-200 communications interface or optional external power supply unit. The CPU sensor power supply (24 V DC) is not brought into load
- Rated value (DC)	
Input current	120 mA
- Rated value at 24 V DC	
MPI	
• Transmission rate (PPI), max.	187.5 kBit/s
1st interface	
• Physical	RS 485
Functionality	
- PPI	Yes
PPI	
- Number of stations	126; S7-200, OP, TP, TBP, PG/PC
Operator control and monitoring	
Display	
- Type	LCD backlight
- Number of lines	2
- Number of characters per line	20; Chars/line: ASCII, Cyrillic; 10 chars per line: Chinese
- Height of characters	5 mm
Environmental requirements	
Operating temperature	
- min.	0 °C
- max.	60 °C
Storage/transportation temperature	
- min.	-40 °C
- max.	70 °C
Degree of protection and class of protection	
- IP 65	Yes; frontal
Dimensions and weight	
• Weight, approx.	250 g
• Width	148 mm
• Height	76 mm
• Depth	27 mm
• Installation cutout, width	138 mm
• Installation cutout, height	68 mm
• Cabinet/control panel thickness	0.3 mm; 0.3 to 4 mm

Overview

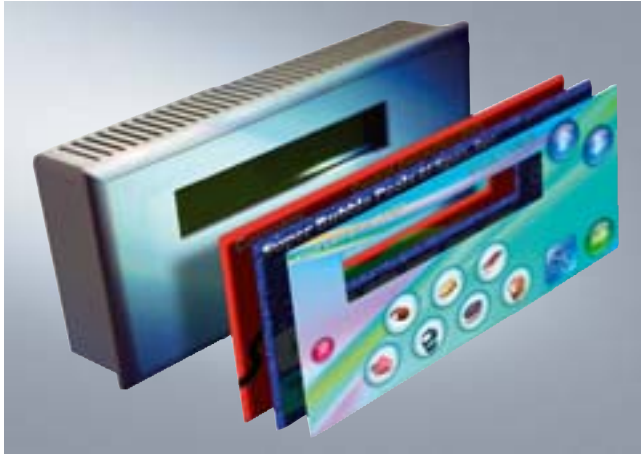

- The user-friendly text display for the S7-200 with customizable display
- For control and monitoring: Message text display, intervention in PLC program, setting of inputs and outputs
- Direct connection to CPU interface using supplied cable or incorporation into network (also via EM 277)
- No separate power supply required
- No separate parameterization software required
- Frontpanel design can be individually selected
- Addressing and setting of contrast in supplied menu

Ordering Data

Order No.

Ordering Data	Order No.
Text Display TD 200C ^{A)} With individually configurable control elements on the front of the device; for connecting to SIMATIC S7-200; can be used with STEP 7-Micro/WIN V4 and higher	6ES7 272-1AA10-0YA0
PROFIBUS bus connector IP20 with 90° cable feeder	
•without PG connection	6ES7 972-0BA12-0XA0
•with PG connection	6ES7 972-0BB12-0XA0
PROFIBUS bus connector IP20 with 35° cable feeder	
•without PG connection	6ES7 972-0BA41-0XA0
•with PG connection	6ES7 972-0BB41-0XA0
PROFIBUS FC Standard Cable for connecting to PPI; standard type with special design for quick mounting, 2-wire, shielded, sold by the meter, up to 1000 m, minimum order 20 m	6XV1 830-0EH10

A) Subject to export regulations: AL: N and ECCN: EAR99H

Technical specifications

6ES7 272-1AA10-0YA0	
Power supply	
Input voltage	24 V; Power supplied through the S7-200 communications interface or optional external power supply unit. The CPU sensor power supply (24 V DC) is not brought into load
- Rated value (DC)	
Input current	120 mA
- Rated value at 24 V DC	
MPI	
•Transmission rate (PPI), max.	187.5 kBit/s
1st interface	
•Physical	RS 485
Functionality	
- PPI	Yes
PPI	
- Number of stations	126; S7-200, OP, TP, TBP, PG/PC
Operator control and monitoring	
Display	
- Type	STN graphics display, LED backlighting
- Number of lines	2
- Number of characters per line	20; Chars/line: ASCII, Cyrillic; 10 chars per line: Chinese
- Height of characters	5 mm
Environmental requirements	
Operating temperature	
- min.	0 °C
- max.	60 °C
Storage/transportation temperature	
- min.	-20 °C
- max.	70 °C
Degree of protection and class of protection	
- IP 65	Yes; frontal
Dimensions and weight	
•Weight, approx.	200 g
•Width	148 mm
•Height	76 mm
•Depth	28 mm
•Installation cutout, width	138 mm
•Installation cutout, height	68 mm
•Cabinet/control panel thickness	0.3 mm; 0.3 to 4 mm

SIMATIC S7-200

Human Machine Interface

SIMATIC TP 177micro

3

Overview



- Touch panel for operator control and monitoring of small machines and plants
- Low-cost starter unit in the category of touch panels with graphics capability complete with all the basic functions required for simple tasks
- Pixel graphics 5.7" STN Touch Screen (analog/resistive), Blue-mode (4 levels)
- Specifically for SIMATIC S7-200:
Communication to the PLC is performed via the integrated interface over a point-to-point connection
- Connected to the PLC via MPI or PROFIBUS DP cable
- The SIMATIC TP 177micro is the innovative successor to the SIMATIC TP 070/TP 170micro Touch Panels
- Ships end of 4th quarter 2004

Configuration

Configuring is carried out with the engineering software SIMATIC WinCC flexible Micro, Compact, Standard or Advanced (see HMI software/engineering software SIMATIC WinCC flexible).

The necessary HardwareSupportPackage (HSP) can be downloaded free of charge via the following link:
<http://www4.ad.siemens.de/WW/view/en/19241467>

Importing of TP-Designer projects (TP 070) into WinCC flexible is not possible.

A PC/PPI adaptor cable is needed to download the configuration.

Technical specifications

Type	TP 177micro
Display	STN liquid crystal display (LCD)
•Size	5.7"
•Resolution (W x H in pixels)	320 x 240 (240 x 320 with vertical design)
•Colors	4 blue levels
•MTBF backlighting (at 25 °C)	Approx. 50,000 hours
Control elements	Touch screen
•Numeric/alphanumeric input	Yes / Yes ¹⁾
Processor	ARM CPU
Memory	
•Type	Flash / RAM
•Usable memory for user data	256 KB
Ports	1 x RS 485
Interface with PLC	S7-200
Power supply	24 V DC
•Permitted range	+18 V to +30 V DC
•Nominal current	0.24 A
Clock	Software clock, without battery backup
Degree of protection	
•Front	IP65 (in installed state), NEMA 4, NEMA 4x, NEMA 12
•Rear	IP20
Certification	Available soon: FM, cULus, CE, C-Tick
Dimensions	
•Front W x H (mm)	212 x 156
•Cut-out W x H (mm)	198 x 142
Weight	0.7 kg
Ambient conditions	
•Mounting position	Vertical
- Max. permissible angle of inclination without forced ventilation	2)
•Temperature	
- Operation (vertical installation)	0 °C to +50 °C 2)
- Operation (max. inclination)	2)
- Transport, storage	-20 °C to +60 °C
•Max. relative humidity	2)

1) English font only can be displayed

2) Status not yet established before going to print

3) Not battery-backed

Note:

All specified values are maximum values.

The total number of configurable elements is limited by the size of the user memory.

Type	TP 177micro
Functions	
Message system	
•No. of messages	500
•Bit messages	Yes
•Analog messages	No
•No. of process values per message	8
•Message buffer	Circulating buffer, 128 entries each ³⁾
Process diagrams	250
•Text objects	500 text elements
•Variables per diagram	20
•Entries per diagram	20
•Graphics objects	Bitmaps, icons, background images
•Dynamic objects	Bars
- Directories	Yes
Variables	250
User administration (security)	Yes
Online languages	5
•Project languages (incl. system messages)	Danish, German, traditional Chinese, simplified Chinese, English, Finnish, French, Greek, Italian, Japanese, Korean, Dutch, Norwegian, Polish, Portuguese, Russian, Swedish, Spanish, Czech, Turkish, Hungarian
Character set	WinCC flexible, ideographic languages
Configuration tool	From WinCC flexible 2004 Micro HSP for OP 73micro, OP 73, OP 77A, TP 177micro, TP 177A (to be ordered separately)
•Configuration transfer	Serial via RS 485

SIMATIC S7-200

Human Machine Interface

SIMATIC TP 177micro

3

Ordering Data	Order No.
SIMATIC TP 177micro ^{E)} Touch Panel for connection to the SIMATIC S7-200, 5.7" STN display	6AV6 640-0CA11-0AX0
Starter pack TP 177micro ^{E)} comprising: <ul style="list-style-type: none"> • TP 177micro touch panel • SIMATIC WinCC flexible Micro engineering software • SIMATIC HMI Manual Collection, 5 languages (English, German, French, Italian, Spanish) comprising all currently available user manuals, product manuals and communication manuals for SIMATIC HMI • MPI cable (5 m) 	6AV6 650-0DA01-0AA0
Configuration with SIMATIC WinCC flexible HSP OP 73micro, OP 73, OP 77A, TP 177micro, TP 177A: http://www4.ad.siemens.de/WWW/view/en/19241467	see catalog ST 80
Documentation (to be ordered separately) Instruction manual OP 73micro, TP 177micro <ul style="list-style-type: none"> • German • English • French • Italian • Spanish 	6AV6 691-1DF01-0AA0 6AV6 691-1DF01-0AB0 6AV6 691-1DF01-0AC0 6AV6 691-1DF01-0AD0 6AV6 691-1DF01-0AE0
User manual WinCC flexible Micro <ul style="list-style-type: none"> • German • English • French • Italian • Spanish 	6AV6 691-1AA01-0AA0 6AV6 691-1AA01-0AB0 6AV6 691-1AA01-0AC0 6AV6 691-1AA01-0AD0 6AV6 691-1AA01-0AE0
SIMATIC HMI Manual Collection Electronic documentation, on CD-ROM 5 languages (English, French, German, Italian and Spanish) comprising all currently available user manuals, product manuals and communication manuals for SIMATIC HMI	6AV6 691-1SA01-0AX0

Ordering Data	Order No.
Accessories for supplementary ordering	
Protective foil (pack of 10)	6AV6 671-2XC00-0AX0
Service package comprising: <ul style="list-style-type: none"> • Gaskets • Clamp-type terminals • Plug-in terminal strip (block of two) 	6AV6 671-2XA00-4AX0
PC/PPI cable Multimaster ^{1) A)} for connecting the S7-200 to serial PC/OP interface and for downloading the configuration for Micro Panels	6ES7 901-3CB30-0XA0
PROFIBUS 830-1T connecting cable For connection of data terminal, precut/preassembled with two sub D connectors, 9-pin, 3 m	6XV1 830-1CH30
System interfaces	see catalog ST 80
Connecting cables	see catalog ST 80

1) The PC/PPI cable with Order No. 6ES7 901-3BF21-0XA0 can also still be used

A) Subject to export regulations AL: N and ECCN: EAR99H

E) Subject to export regulations AL: N and ECCN: 5D002ENC3A

Overview

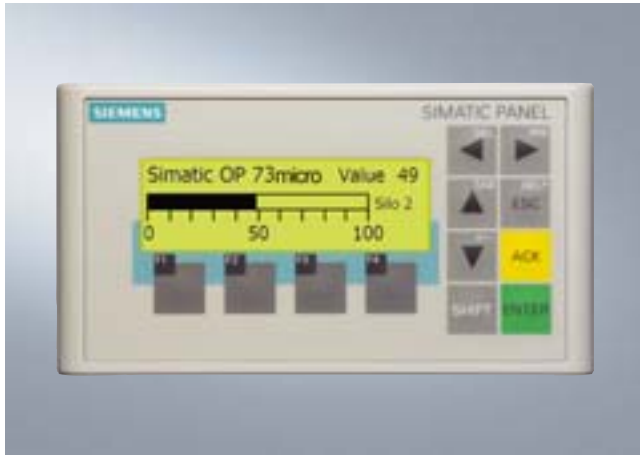

- Operator panel for operator control and monitoring of small machines and plants
- A new dimension in graphics: small and clever
- Pixel graphics 3" LCD, monochrome
- 8 system keys, 4 freely configurable function keys
- Specifically for SIMATIC S7-200:
Communication with the controller is point-to-point using the integral interface
- Connected to the PLC via MPI or PROFIBUS DP cable
- Start of delivery approximately end of 4th quarter 2004

Technical specifications

Type	OP 73micro
Display	LCD
•Size	3"
•Resolution (W x H in pixels)	160 x 48
•Colors	Monochrome (yellow-green)
•MTBF of background lighting (at 25°C)	Approx. 100,000 hours
Control elements	Membrane keyboard
•Function keys, programmable	4 function keys
•System keys	8
•Numeric/alphanumeric input	Yes/yes ¹⁾
Processor	ARM CPU
Memory	
•Type	Flash
•Usable memory for user data	128 KB
Ports	1 x RS 485
Interface with PLC	S7-200
Power supply	24 V DC
•Permitted range	+18 to +30 V DC
•Nominal current	0.1 A
Clock	Software clock, without battery backup
Degree of protection	
•Front	IP65 (in installed state) NEMA 12, NEMA 4x, NEMA4
•Rear	IP20
Certification	Available soon: FM, cULus, CE, C-Tick
Dimensions	
•Front W x H (mm)	154 x 84
•Cut-out W x H (mm)	138 x 68
Weight	0.3 kg

1) English font only can be displayed

2) Status not yet established before going to print

3) Not battery-backed

Note:

All specified values are maximum values.

The total number of configurable elements is limited by the size of the user memory.

Type	OP 73micro
Ambient conditions	
•Mounting position	Vertical ²⁾
- max. permissible angle of inclination without forced ventilation	
•Temperature	
- Operation (vertical installation)	0 °C to +50 °C ²⁾
- Operation (max. inclination)	
- Transport, storage	-20 °C to +70 °C ²⁾
•Max. relative humidity	
Functions	
Message system	
•No. of messages	250
•Bit messages	Yes
•Number of process values per message	8
•Message buffer	Circulating buffer, 128 entries each ³⁾
Process diagrams	250
•Text objects	1000 text elements
•Variables per diagram	20
•Fields per diagram	20
•Graphics objects	250
•Dynamic objects	Bars
- Directories	Yes
Variables	500
User administration (security)	Yes
Online languages	5
Project languages (incl. system messages)	Danish, German, traditional Chinese, simplified Chinese, English, Finnish, French, Greek, Italian, Japanese, Korean, Dutch, Norwegian, Polish, Portuguese, Russian, Swedish, Spanish, Czech, Turkish, Hungarian
Character set	WinCC flexible, ideographic languages
Help system	Yes
Task planner	Yes
Configuration tool	From WinCC flexible 2004 Micro HSP for OP 73micro, OP 73, OP 77A, TP 177micro, TP 177A (to be ordered separately)
•Transfer of the configuration	Serially via RS485

SIMATIC S7-200

Human Machine Interface

SIMATIC OP 73micro

3

Ordering Data	Order No.
SIMATIC OP 73micro ^{E)} Operator Panel for connecting to the SIMATIC S7-200, with 3" display, mono incl. installation accessories	6AV6 640-0BA11-0AX0
Starter pack OP 73micro ^{E)} comprising: <ul style="list-style-type: none"> • Operator Panel OP 73micro • SIMATIC WinCC flexible Micro engineering software • SIMATIC HMI Manual Collection, 5 languages (English, German, French, Italian, Spanish), comprising all currently available user manuals, product manuals and communication manuals for SIMATIC HMI • MPI cable (5 m) 	6AV6 650-0BA01-0AA0
Configuration with SIMATIC WinCC flexible HSP OP 73micro, OP 73, OP 77A, TP 177micro, TP 177A: http://www4.ad.siemens.de/WW/view/en/19241467	see catalog ST 80
Documentation (to be ordered separately) Instruction manual OP 73micro/TP 177micro ¹⁾ <ul style="list-style-type: none"> • German 6AV6 691-1DF01-0AA0 • English 6AV6 691-1DF01-0AB0 • French 6AV6 691-1DF01-0AC0 • Italian 6AV6 691-1DF01-0AD0 • Spanish 6AV6 691-1DF01-0AE0 	
User manual WinCC flexible Micro <ul style="list-style-type: none"> • German 6AV6 691-1AA01-0AA0 • English 6AV6 691-1AA01-0AB0 • French 6AV6 691-1AA01-0AC0 • Italian 6AV6 691-1AA01-0AD0 • Spanish 6AV6 691-1AA01-0AE0 	
SIMATIC HMI Manual Collection Electronic documentation, on CD-ROM 5 languages (English, French, German, Italian and Spanish); Comprising: all currently available user manuals, product manuals and communication manuals for SIMATIC HMI	6AV6 691-1SA01-0AX0

Ordering Data	Order No.
Accessories for supplementary ordering Service package comprising: <ul style="list-style-type: none"> • Gaskets • 5 clamps • Clamp-type terminal strip (block of two) 	6AV6 671-1XA00-0AX0
PC/PPI Multimaster cable ^{1) A)} For connecting the S7-200 to serial PC/OP interface and for downloading the configuration for Micro Panels	6ES7 901-3CB30-0XA0
PROFIBUS 830-1T connecting cable For connection of data terminal, precut/preassembled with two sub D connectors, 9-pin, terminated at both ends, 3 m	6XV1 830-1CH30
System interfaces	see catalog ST 80
Connecting cables	see catalog ST 80

1) The PC/PPI cable with Order No. 6ES7 901-3BF21-0XA0 can also still be used

A) Subject to export regulations AL: N and ECCN: EAR99H

E) Subject to export regulations AL: N and ECCN: 5D002ENC3A

Overview

- Software for the SIMATIC S7-200
- Functions for all phases of an automation project:
 - Planning, configuring and parameterization of hardware and communication
 - Creation of a user program
 - Documentation
 - Testing, commissioning and service
 - Process control
 - Archiving

The following are available:

- STEP 7- Micro/WIN
- STEP 7 Micro/WIN command library
- WinCC flexible micro
- S7-200 PC-Access

For further information see section 7.



3

SIMATIC S7-300



4/2 4/2	Introduction S7-300/S7-300F	
4/4 4/4	Central processing units CPU 312C to CPU 317F-2 DP	
4/38 4/38	SIPLUS central processing units SIPLUS CPU 312C, CPU 313C, CPU 314, CPU 315-2 DP	
4/40 4/40 4/46 4/52	Digital modules SM 321 digital input modules SM 322 digital output modules SM 323/SM 327 digital I/O modules	
4/56 4/56 4/57 4/58	SIPLUS digital modules SIPLUS SM 321 digital input modules SIPLUS SM 322 digital output modules SIPLUS SM 323 digital input/output modules	
4/59 4/59 4/66 4/69 4/72	Analog modules SM 331 analog input modules SM 332 analog output modules SM 334 analog I/O modules SM 335 fast analog I/O module	
4/74 4/74 4/75 4/76	SIPLUS analog modules SIPLUS SM 331 analog input modules SIPLUS SM 332 analog output modules SIPLUS SM 334 analog input/output modules	
4/77 4/77 4/80 4/82	F digital / analog modules SM 326 F digital input - Safety Integrated SM 326 F digital output - Safety Integrated SM 336 F analog input - Safety Integrated	
4/84 4/84 4/85	SIPLUS F digital modules SIPLUS SM 326 F digital input - Safety Integrated SIPLUS SM 326 F digital output - Safety Integrated	
4/86 4/86 4/89	Ex input / output modules Ex digital I/O modules Ex analog I/O modules	
4/93 4/93 4/95 4/97 4/99	Function modules FM 350-1 counter module FM 350-2 counter module FM 351 positioning module FM 352 electronic cam controller	
		Function modules (continued) 4/101 FM 352-5 High-Speed Boolean Processor 4/105 FM 353 positioning module 4/107 FM 354 positioning module 4/109 FM 357-2 positioning module 4/111 FM STEPDRIVE power section 4/112 1FL3 stepper motors 4/114 FM 355 closed-loop control modules 4/117 FM 355-2 closed-loop temperature control modules 4/120 SM 338 ultrasonic position encoder 4/122 SM 338 POS input module 4/124 SIWAREX U 4/125 SIWAREX M
		4/128 IQ-Sense modules and sensors 4/128 IQ-Sense sensor modules 4/129 IQ-Sense photoelectric sensors 4/131 IQ-Sense ultrasonic sensors
		4/132 Special modules 4/132 SM 374 simulator 4/133 DM 370 dummy module
		4/134 Communication 4/134 CP 340 4/136 SIPLUS CP 340 4/137 CP 341 4/140 CP 343-2 4/141 CP 343-2 P 4/142 CP 342-5 4/144 CP 342-5 FO 4/146 CP 343-5 4/148 CP 343-1 Lean 4/150 CP 343-1 4/152 CP 343-1 IT 4/154 CP 343-1 PN
		4/156 Connection methods 4/156 Front connector 4/157 Fully modular connection 4/160 Flexible connection
		4/162 Interface modules 4/162 IM 360/-361/-365 interface modules
		4/163 SIPLUS interface modules 4/163 SIPLUS IM 365 interface module
		4/164 Power supplies 4/164 Power supplies
		4/168 Accessories 4/168 DIN rail 4/169 Labeling sheets



S7-300

- The modular mini PLC system for the low and medium performance ranges
- With comprehensive range of modules for optimum adaptation to the automation task
- Flexible use through simple implementation of distributed structures and versatile networking
- Convenient system as result of user-friendly handling and uncomplicated, fan-free configuration
- Can be expanded without problems when the tasks increase
- Powerful thanks to a large number of integrated functions

S7-300F

- Failsafe automation system for plants with increased safety requirements for production engineering
- Based on S7-300
- ET 200S and ET 200M distributed I/O stations with safety-relevant modules can also be connected; safety-relevant communication via PROFIBUS DP with PROFISAFE profile.
- Standard modules can be used in addition for non-safety-relevant applications

SIPLUS S7-300

- The PLC for use in the harshest environmental conditions
- With extended temperature range from -25 to +70°C
- Suitable for extraordinary medial load (pollution gas atmosphere)
- Occasional short-term condensation and increased mechanical loading permissible
- With the proven PLC technology of the S7-300
- Convenient handling, programming, maintenance and service
- Ideal for use in the automotive industry, environmental technology, mining, chemical plants, production technology, food industry etc.
- The alternative to expensive custom solutions

More Information you can find at:

<http://www.siemens.com/siplus>

Technical specifications

General technical specifications S7-300, S7-300F

Degree of protection	Degree of protection IP20 to IEC 60 529
Ambient temperature	
•With horizontal mounting	0 to 60 °C
•With vertical mounting	0 to 40 °C
Relative humidity	5 to 95%, no condensation (RH severity level 2 in accordance with IEC 61131-2)
Atmospheric pressure	795 to 1080 hPa
Isolation	
•24 V DC circuits	Test voltage 500 V DC
•230 V AC circuits	Test voltage 1460 V AC
Electromagnetic compatibility	Requirements of EMC law; Noise immunity according to IEC 61000-6-2, tested according to: IEC 61000-4-2, 61000-4-3, IEC 61000-4-4, IEC 61000-4-5, IEC 61000-4-6 Emitted interference according to EN 50081-2, tested according to EN 55011, class A, group 1
Mechanical rating	
•Vibrations, tested according to/tested with	IEC 60068, Part 2-6/10 up 58 Hz; constant amplitude 0.075 mm; 58 to 150 Hz; constant acceleration 1 g; oscillation period: 10 frequency cycles per axis in each direction of the 3 mutually perpendicular axes
•Shock, tested according to/tested with	IEC 60068, Part 2-27/half-sine: strength of impact 15 g (peak value), duration 11 ms

General technical specifications SIPLUS S7-300

Ambient temperature	
Temperature	Horizontal mounting: -25 °C to 70 °C Vertical mounting: -25 °C to 50 °C
Relative humidity	5 to 95%; transient condensation permissible, corresponding to relative humidity (RH-) stress grade 2 according to IEC 1131-2 and IEC 721 3-3 Cl. 3K5
Transient icing	-25 °C to 0 °C IEC 721 3-3 Cl. 3K5
Atmospheric pressure	1080 to 795 hPa corresponding to a height of -1000 to 2000 m
Pollutant concentration	SO ₂ : < 0,5 ppm; relative humidity <60% Test: 10 ppm, 4 days H ₂ S: < 0,1 ppm; relative humidity <60% Test: 1 ppm, 4 days (according to IEC 721 3-3; Class 3C3)
Mechanical environmental conditions	
Vibrations	Type of vibration: frequency progressions changing at 1 octave per minute. 2 Hz ≤ f ≤ 9 Hz, constant amplitude 3,0 mm 9 Hz ≤ f ≤ 150 Hz, constant acceleration 1 g; Duration of vibration: 10 frequency progressions per axis in each direction of the three mutually perpendicular axes; Vibration testing according to IEC 68 section 2-6 (Sinus) and IEC 721 3-3, Class 3M4
Shock	Type of shock: semisinusoidal shock strength: 15 g peak value, duration shock direction 11 ms: 3 shocks each in +/- direction on each of the mutually perpendicular axes Shock testing according to IEC 68 section 2-27
Conformity	EN 50155 (railroad applications - electronic device on rail vehicles)

SIMATIC S7-300

Central processing units

CPU 312C to CPU 317F-2 DP

4

CPU 312C



- The compact CPU with integrated digital inputs and outputs
- For small applications with high requirements in terms of processing power
- With process-related functions

Micro memory card required to operate the CPU.

CPU 313C-2 PtP



- The compact CPU with integrated digital I/Os and second serial interface
- For installations with high requirements in terms of processing power and response time.
- With process-related functions

Micro memory card required to operate the CPU.

CPU 313C



- The compact CPU with integrated digital and analog inputs and outputs
- For installations with high requirements in terms of processing power and response time.
- With process-related functions

Micro memory card required to operate the CPU.

CPU 313C-2 DP



- The compact CPU with integrated digital I/Os and PROFIBUS DP master/slave interface
- With process-related functions
- For tasks with special functions
- For the connection of standalone I/O devices

Micro memory card required to operate the CPU.

CPU 314C-2 PtP



- The compact CPU with integrated digital and analog I/Os, as well as a second serial interface
- For installations with high requirements in terms of processing power and response time
- With process-related functions

Micro memory card required to operate the CPU.

CPU 312



- The starter CPU for Totally Integrated Automation (TIA).
- For small-scale applications with moderate requirements on the processing speed.

Micro memory card required to operate the CPU.

CPU 314C-2 DP



- The compact CPU with integrated digital and analog I/Os and PROFIBUS DP master/slave interface
- With process-related functions
- For tasks with special functions
- For the connection of standalone I/O devices

Micro memory card required to operate the CPU.

CPU 314



- For installations with medium requirements on program scope
- High processing performance in binary and floating-point arithmetic

Micro memory card is required to operate the CPU.

SIMATIC S7-300

Central processing units

CPU 312C to CPU 317F-2 DP

4

CPU 315-2 DP



- The CPU with medium to large program memory and quantity framework for the use, if required, of SIMATIC Engineering Tools
- High processing performance in binary and floating-point arithmetic
- PROFIBUS DP master/slave interface
- For extensive I/O configurations
- For setting up distributed I/O structures

Micro memory card required for operation of CPU.

CPU 318-2 DP



- The CPU with a large program memory and PROFIBUS DP master/slave interface
- For extensive I/O configurations
- For setting up distributed I/O structures

CPU 317-2 DP



- The CPU with a large program memory and quantity framework for demanding requirements
- For multisector automation tasks in the construction of series machines, special machines and plants
- Used as a central controller on production lines with central and distributed I/O
- High processing performance in binary and floating-point arithmetic
- PROFIBUS DP master/slave interface
- For extensive I/O configurations
- For setting up distributed I/O structures
- Supports as an option the use of SIMATIC Engineering Tools
- Distributed intelligence in Component based Automation (CBA) on PROFIBUS DP

Micro memory card required for operation of CPU.

CPU 317-2 PN/DP



- The CPU with a large program memory and quantity framework for demanding requirements
- Distributed intelligence in Component based Automation (CBA) on PROFINET
- PROFINET proxy for intelligent devices on PROFIBUS DP in Component based Automation (CBA)
- PROFINET I/O controller for operating distributed I/O on PROFINET
- For multisector automation tasks in the construction of series machines, special machines and plants
- Used as a central controller on production lines with central and distributed I/O
- For extensive I/O configurations
- For setting up distributed I/O structures
- High processing performance in binary and floating-point arithmetic
- Combined MPI/PROFIBUS DP-master/slave interface
- Supports as an option the use of SIMATIC Engineering Tools

Micro memory card required for operation of CPU.

CPU 317T-2 DP



- SIMATIC CPU with integrated technology/motion control functionality
- With the full functionality of the standard CPU 317-2 DP
- For multisector automation tasks in the construction of series machines, special machines and plants
- Ideal for synchronized motion sequences such as coupling to a virtual/real master, gearbox synchronism, cam disc or print-mark correction.
- Used as a central controller on production lines with central and distributed I/O
- Distributed intelligence in Component Based Automation (CBA) on PROFIBUS DP
- With onboard I/O for fast technological functions (e.g., cam switching, reference point detection)
- PROFIBUS DP (DRIVE) interface for the isochronous connection of drive components.
- A common S7 application program for control and motion control tasks (no additional programming language for motion control required)
- Optional "S7 Technology" package required

CPU 315F-2 DP



- For configuration of a failsafe automation system for plants with increased safety requirements
- Based on the SIMATIC CPU 315-2 DP
- With 2 interfaces (1x MPI, 1x DP/MPI)
- Complies with safety requirements up to SIL 3 to IEC 61508, AK6 to DIN V 19250 and Cat. 4 to EN 954-1
- Without additional wiring of safety-relevant I/O
- Safety-relevant communication via PROFIBUS DP with *PROFISAFE* profile with distributed I/O stations
- Distributed connection of failsafe ET200S PROFISAFE I/O modules possible; Central and distributed connection of failsafe ET200M I/O modules possible
- Central and distributed use of standard modules for non-safety-relevant applications

Micro memory card required for operation of CPU.