

SNAP High-Density Digital I/O Modules

Features

- 16 or 32 digital input points or output points in one compact SNAP module
- Up to 16 high-density digital modules on a SNAP rack, making up to 512 digital points available on one rack
- Convenient pluggable wiring harness, breakout boards, and header cables (available separately)
- Rugged packaging
- Operating temperature: 0 to 70 °C

Description

SNAP high-density digital (HDD) modules from Opto 22 provide 16 or 32 digital input or output points in one compact SNAP module. All HDD modules work with the SNAP PAC System, which consists of SNAP PAC controllers and brains, SNAP PAC racks, SNAP I/O modules, and PAC Project software. These modules can also be used in intelligent remote I/O for Allen-Bradley® Logix PLC systems.

SNAP high-density digital modules are ideal for OEMs and for anyone who has high point-count applications. The high-density point configuration reduces per-point costs of digital I/O systems by providing up to eight times as many I/O points in the same space.

The following high-density digital modules are available:

- The **SNAP-IDC-32** or **SNAP-IDC-32-FM** digital input module, with 32 input points, can be used to sense on/off status for 10–32 VDC inputs from sources such as proximity switches, limit switches, push buttons, and pilot switches (PNP or sourcing type).
- The **SNAP-IDC-32N** is similar, but its input range is -10 to -32 VDC and its common connections are positive rather than negative, making it ideal for NPN or sinking type inputs.
- The **SNAP-IDC-16** digital input module offers 16 points with channel-to-channel isolation. It can sense on/off status for 10–32 VDC/VAC loads.
- The **SNAP-IDC-HT-16** leakage tolerant digital input module is used with proximity switches. It offers channel-to-channel isolation for 16 points and senses on/off status for loads of 15–28 VDC/VAC.
- **SNAP-IAC-16**, **SNAP-IAC-A-16**, and **SNAP-IAC-K-16** digital input modules each have 16 points with channel-to-channel isolation. These modules sense on/off status



SNAP-IDC-32 high-density digital input module

for 90–140 VAC (SNAP-IAC-16), 180–280 VAC (SNAP-IAC-A-16), or 70–130 VAC (SNAP-IAC-K-16).

- SNAP-ODC-32-SRC, **SNAP-ODC-32-SRC-FM**, **SNAP-ODC-32-SNK**, and **SNAP-ODC-32-SNK-FM** digital output modules have 32 points and can switch on and off 5–60 VDC loads, either sourcing or sinking.

Module part numbers ending in -FM are Factory Mutual approved.

Part Numbers

Part	Description
Modules	
SNAP-IDC-32 SNAP-IDC-32-FM*	SNAP 32-point digital input module, 10–32 VDC
SNAP-IDC-32N	SNAP 32-point digital input module, -10 to -32 VDC, with positive common connection
SNAP-IDC-16	SNAP isolated 16-point digital input module, 10–32 VDC/VAC
SNAP-IDC-HT-16	SNAP leakage-tolerant isolated 16-point digital input module, 15–28 VDC/VAC
SNAP-IAC-16	SNAP isolated 16-point digital input module, 90–140 VAC/VDC
SNAP-IAC-A-16	SNAP isolated 16-point digital input module, 180–280 VAC/VDC
SNAP-IAC-K-16	SNAP isolated 16-point digital input module, 70–130 VAC/VDC
SNAP-ODC-32-SRC SNAP-ODC-32-SRC-FM*	SNAP 32-point digital output module, 5–60 VDC load sourcing
SNAP-ODC-32-SNK SNAP-ODC-32-SNK-FM*	SNAP 32-point digital output module, 5–60 VDC load sinking
Accessories	
OPTOTERMINAL-G20	Terminal with operator controls for use with SNAP high-density digital modules

* Factory Mutual approved

SNAP High-Density Digital I/O Modules

All HDD input modules feature automatic counting and latching. DC models are ideal for detecting low-voltage auxiliary contacts.

Mounting Racks

SNAP high-density digital modules are designed to work with SNAP PAC mounting racks. Up to 16 modules can be mounted on a rack, making up to 512 digital points available. In addition, HDD modules can be mixed with 4-channel SNAP digital, analog, and serial modules on the same rack.

SNAP racks use a retention rail locking system that holds modules securely to the rack. Normally, a hold-down screw is not required. However, for applications that require additional module security, each module has provisions for two 4-40 by 1/2-inch standard machine screws to hold each module in position on the SNAP rack.

Wiring Aids: Breakout Boards, Wiring Harnesses, and Header Cables

Due to space constraints, instead of using the usual removable terminal connectors, high-density digital modules use other wiring devices. These cables and breakout boards are available separately and are detailed in form 1756, the *SNAP TEX Cables and Breakout Boards Data Sheet*, available on our website.

SNAP breakout boards for high-density digital modules provide LED indicators as well as labeled and easily accessible fused connectors for input or output points, all of which simplify connecting field devices to HDD modules.

For a table showing compatible boards, cables, and modules, see the *SNAP TEX Cables and Breakout Boards Data Sheet*.



SNAP-IDC-HDB breakout board

If you are not using breakout boards, you can connect 16-point input modules directly to field devices or terminal strips using the **SNAP-HD-ACF6** wiring harness assembly. The assembly includes two 8-point connectors that plug securely into the top of the module and provide flying leads at the field end.

Similarly, 32-point modules can connect to field devices with the **SNAP-HD-CBF6** wiring harness, which plugs into the top of the module and provides flying leads.

G4 Digital I/O Connectivity

SNAP-ODC-32-SNK digital output modules can connect to G4PB16 mounting racks using the **SNAP-HD-G4F6** header cable to integrate older G4 digital output I/O systems with modern PAC Project software and SNAP Ethernet-based controllers. This connection makes available the G4 I/O's 3-amp switching capability, which provides twelve times the 0.25 amp capability per point of the high-density digital modules themselves.

SNAP Product Compatibility

SNAP HDD modules are compatible with the SNAP PAC System and can be used on SNAP PAC mounting racks with SNAP PAC R-series controllers and SNAP PAC EB and SB brains. These modules can be used with both standard wired Ethernet controllers and brains and with Wired+Wireless™ models.

Other digital, analog, and serial SNAP I/O modules can be placed on the same rack with HDD modules for the mix of signals required at any location.

NOTE: For information on using HDD modules in older systems, see form #1688, the *SNAP PAC System Migration Technical Note*.

Programming

Opto 22 PAC Control software version 8.0 or newer is required if you are using SNAP high-density digital modules with a SNAP PAC controller. SNAP HDD modules can also be accessed by custom software built with the OptoMMP Communication Toolkit or by communication with an EtherNet/IP or Modbus/TCP system.

See Opto 22 form 1547, the *SNAP High-Density Digital Modules User's Guide*, for detailed information on using these modules in a PAC Control strategy. The OptoMMP Communication Toolkit is documented in Opto 22 form 1465, the *OptoMMP Protocol Guide*. Communication with A-B PLC systems is covered in form 1770, the *EtherNet/IP for SNAP PAC Protocol Guide*. For Modbus/TCP systems, see form 1678, the *Modbus/TCP Protocol Guide*.

SNAP High-Density Digital I/O Modules

OptoTerminal-G20

SNAP high-density digital modules have a diagnostic port for commissioning and troubleshooting using the optional

OptoTerminal-G20

operator interface terminal. The OptoTerminal-G20 displays the status of a high-density digital module's points on a two-line LCD display and can also be used to turn output points on and off. See



OptoTerminal-G20

Opto 22 form 1547, the *SNAP High-Density Digital Modules User's Guide*, for more information.

Connecting to G4 Digital I/O

SNAP-ODC-32-SNK digital output modules and SNAP-IDC-32N digital input modules can connect to G4PB16 mounting racks using the **SNAP-HD-G4F6** header cable. This cable allows older G4 (or even G1) digital I/O systems to take advantage of modern Opto 22 products like SNAP PAC controllers, SNAP PAC brains, and PAC Project software.

For more information, see form #1756, the *SNAP TEX Cables and Breakout Boards Data Sheet*.

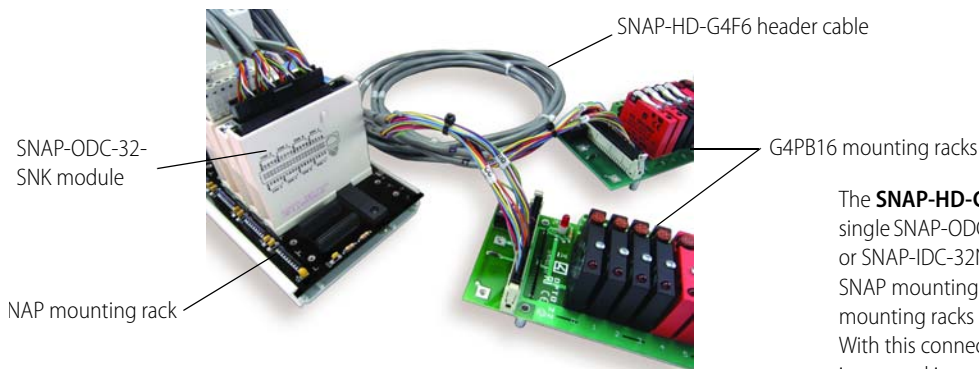

SNAP-ODC-32-SNK module

SNAP mounting rack

SNAP-HD-G4F6 header cable

G4PB16 mounting racks

NOTE: This cable does not work with SNAP-ODC-32-SRC modules.

NOTE: For the SNAP-IDC-32N module, you must use 15 volt or 24 volt G1 or G4 modules. The 5 volt modules will not work.

The **SNAP-HD-G4F6** header cable connects a single SNAP-ODC-32-SNK digital output module or SNAP-IDC-32N digital input module on a SNAP mounting rack to two G4 (or G1) mounting racks with header connectors. With this connection, older I/O systems can be integrated into a modern SNAP I/O system and take advantage of Ethernet networking, SNAP PAC controllers, and PAC Project software.

Comparing SNAP Digital Modules

IMPORTANT: SNAP high-density digital modules differ from each other and from 4-channel SNAP digital modules in several critical areas, including electrical capabilities and I/O performance.

You must consider these differences when deciding which SNAP digital module to use for an application. For example, while a SNAP-IDC-32 digital input module provides 32 I/O points on one module, it does not provide the channel-to-channel isolation of a SNAP-IDC-16 with 16 channels or a SNAP-IDC5 with 4. See the table "[Comparing SNAP High-Density and 4-Channel Digital Modules](#)" on page 4 for a comparison of capabilities.

Counting

Digital counting is an important area in which HDD input modules differ from 4-channel SNAP digital input modules. Opto 22 has traditionally provided counting capability for any

digital input point when used with a brain that supports high-speed digital features. This counting happens in the brain, not in the module.

SNAP high-density digital modules introduce a different kind of counting, where the counting occurs on the module itself. While the module uses a 16-bit counter (counting only to 65,535), the I/O processor used with the module accumulates counts to 32 bits by periodically getting and clearing the module's counts, and adding each new count to what it already has for that point. However, this is not high-speed counting because it is done on the module, and both the HDD module's speed and communication speed between the brain and the module are limited. Note that counting speed on HDD modules is not deterministic and will vary.

However, this slower counting rate works well for many applications that involve counting at slower speeds—for example, rotating shafts, flow meters with pulsed outputs, and electrical meters tuned to slower speeds.

SNAP High-Density Digital I/O Modules

Comparing SNAP High-Density and 4-Channel Digital Modules

Item	SNAP High-Density Digital Modules	4-Channel SNAP Digital Modules
Number of points on module	16 or 32, depending on module	4
Isolation and fusing	16-point input modules: Each point is optically isolated from other points on the module. 32-point input and output modules: The module is divided into four groups of eight points. Groups are isolated from each other, but points within a group are not isolated from each other. Groups must be externally fused.	Input modules: Each point is optically isolated from other points on the module. Most output modules: Points are not isolated from each other. Points share a common fuse. For isolated modules, see the <i>SNAP Digital Output Modules Data Sheet</i> (form #1144).
Status LEDs	None; use the handheld OptoTerminal-G20 for module diagnostics and commissioning, or for 32-point modules, connect to an optional breakout rack.	One for each point, located on top of module.
Polling time from I/O processor to module ¹	2–30 ms typical ²	0.5–2 ms typical ²
Module turn-on/off time ¹	16-point input modules: 15–20 ms 32-point input modules: 6 ms Output modules: 100 microseconds	Varies by module. Examples: <ul style="list-style-type: none"> • SNAP-IDC5-FAST: 25 microseconds • SNAP-IDC5: 5 ms turn-on, 15 ms turn-off
On/off status	Yes	Yes
Input latching	Yes	Yes
Counting on digital input modules	Counting occurs on the module. ³ Counting is available with SNAP-PAC-R1 ⁴ , SNAP-PAC-EB1 ⁴ , and SNAP-PAC-SB1 processors. Counting speeds: On 32-point modules, 0–50 Hz @ 50% duty cycle On 16-point modules, 0–25 Hz @ 50% duty cycle (Speed depends on module; see specifications for each part number.)	High-speed counting occurs on the I/O processor (brain or on-the-rack controller) and can be configured for any point. (High-speed counting is available on SNAP-PAC-R1 ⁴ , SNAP-PAC-EB1 ⁴ , and SNAP-PAC-SB1 processors.) Counting speed varies based on the processor and the speed of the module. Example: SNAP-PAC-EB1 brain with SNAP-IDC5-FAST: up to 20 KHz
Watchdog timer	Firmware 8.1 and higher, yes. Firmware 8.0 and lower, no.	Yes
Pulse generation	Yes	Yes
On-pulse, off-pulse, and Period measurement	No	Yes
Frequency	No	Yes
Totalizer	No	Yes
Digital events	Firmware 8.1 and higher, yes. Firmware 8.0 and lower, no.	Yes

¹ Actual turn-on and turn-off times equal the polling time plus the module time.

² Polling time varies based on the SNAP I/O processor (brain or on-the-rack controller), processor configuration, and Ethernet host communication activity.

³ The high-density digital module uses a 16-bit counter, but the processor used with the module accumulates counts to 32 bits by periodically getting and clearing the module's counts and adding to current values. Update time varies based on number of modules and Ethernet communication demands.

⁴ Including -FM (Factory Mutual approved) and -W (Wired+Wireless) models.

SNAP High-Density Digital I/O Modules

Specifications

	SNAP-IDC-32 SNAP-IDC-32-FM	SNAP-IDC-32N
Input Range	10 to 32 VDC	-10 to -32 VDC
Nominal Voltage Range	24 VDC	24 VDC
Input Resistance	20 K ohms	20 K ohms
Logic Voltage and Current	5 VDC \pm 0.1 @ 150 mA	5 VDC \pm 0.1 @ 150 mA
Input Arrangement	32 input channels; 4 groups of 8 inputs each (Points in each group share a common negative connection.)	32 input channels; 4 groups of 8 inputs each (Points in each group share a common positive connection.)
Channel-to-Channel Isolation	No channel-to-channel isolation; 100 V group-to-group isolation	No channel-to-channel isolation; 100 V group-to-group isolation
Hold-down screws Connector screws	Torque: 4 in-lb (0.45 N-m) Torque: 5.26 in-lb (0.6 N-m)	Torque: 4 in-lb (0.45 N-m) Torque: 5.26 in-lb (0.6 N-m)
Maximum Number of HDD Modules on One Mounting Rack	16	16
Indicators	None; use optional OptoTerminal-G20 diagnostic display or breakout rack.	None; use optional OptoTerminal-G20 diagnostic display or breakout rack.
ON Voltage	10 VDC @ 0.5 mA	10 VDC @ 0.5 mA
OFF Voltage	3 VDC @ 0.1 mA	3 VDC @ 0.1 mA
Polling time from I/O processor to module ¹	2–30 ms typical ²	2–30 ms typical ²
Input Turn-On/Off Time	6 ms	6 ms
Counting Frequency (DC input)	0–50 Hz @ 50% duty cycle	0–50 Hz @ 50% duty cycle
Agency Approvals	UL, CE, RoHS, DFARS FM (-FM model only)	CE, RoHS, DFARS
Warranty	Lifetime	Lifetime

1 Affects turn-on and turn-off determination

2 Time varies based on the SNAP PAC I/O processor (brain or on-the-rack controller), processor configuration, and Ethernet host communication activity.

SNAP High-Density Digital I/O Modules

Specifications (continued)

	SNAP-IDC-16	SNAP-IDC-HT-16	SNAP-IAC-16	SNAP-IAC-A-16	SNAP-IAC-K-16
Input Range	10–32 VDC/VAC	15–28 VDC/VAC	90–140 VAC/VDC	180–280 VAC/VDC	70–130 VAC/VDC
Nominal Voltage Range	24 VDC	24 VDC	120 VAC	240 VAC	100 VAC
Input Resistance	44 K ohms	4 K ohms	300 K ohms	940 K ohms	220 K ohms
Logic Voltage and Current	5 VDC \pm 0.1 @ 150 mA	5 VDC \pm 0.1 @ 150 mA	5 VDC \pm 0.1 @ 150 mA	5 VDC \pm 0.1 @ 150 mA	5 VDC \pm 0.1 @ 150 mA
Input Arrangement	16 isolated input channels	16 isolated input channels	16 isolated input channels	16 isolated input channels	16 isolated input channels
Channel-to-Channel Isolation	250 V steady-state, 1500 V transient	250 V steady-state, 1500 V transient	250 V steady-state, 1500 V transient	250 V steady-state, 1500 V transient	250 V steady-state, 1500 V transient
Maximum Number of HDD Modules on One Mounting Rack	16	16	16	16	16
Indicators	None; use optional OptoTerminal-G20 diagnostic display.	None; use optional OptoTerminal-G20 diagnostic display.	None; use optional OptoTerminal-G20 diagnostic display.	None; use optional OptoTerminal-G20 diagnostic display.	None; use optional OptoTerminal-G20 diagnostic display.
ON Voltage	10 VDC @ 0.230 mA	15 VDC @ 3.50 mA	90 VAC/VDC @ 0.3 mA	180 VAC/VDC @ 0.191 mA	70 VAC/VDC @ 0.3 mA
OFF Voltage	3 VDC @ 0.05 mA	9 VDC @ 2.0 mA	40 VAC/VDC @ 0.135 mA	40 VAC/VDC @ 0.043 mA	30 VAC/VDC @ 0.135 mA
Torque, hold-down screws	4 in-lb (0.45 N-m)	4 in-lb (0.45 N-m)	4 in-lb (0.45 N-m)	4 in-lb (0.45 N-m)	4 in-lb (0.45 N-m)
Torque, connector screws	5.26 in-lb (0.6 N-m)	5.26 in-lb (0.6 N-m)	5.26 in-lb (0.6 N-m)	5.26 in-lb (0.6 N-m)	5.26 in-lb (0.6 N-m)
Polling time from I/O processor to module ¹	2–30 ms typical ²	2–30 ms typical ²	2–30 ms typical ²	2–30 ms typical ²	2–30 ms typical ²
Input Turn-On/Off Time	15 ms turn-on time 20 ms turn-off time	20 ms turn-on time 25 ms turn-off time	15 ms turn-on time 20 ms turn-off time	15 ms turn-on time 20 ms turn-off time	15 ms turn-on time 20 ms turn-off time
Counting Frequency (DC input)	0–25 Hz @ 50% duty cycle	0–15 Hz @ 50% duty cycle	0–25 Hz @ 50% duty cycle	0–25 Hz @ 50% duty cycle	0–25 Hz @ 50% duty cycle
Agency Approvals	UL, CE, RoHS, DFARS	CE, RoHS, DFARS	UL, CE, RoHS, DFARS	UL, CE, RoHS, DFARS	CE, RoHS, DFARS
Warranty	Lifetime	Lifetime	Lifetime	Lifetime	Lifetime

¹ Affects turn-on and turn-off determination

² Time varies based on the SNAP PAC I/O processor (brain or on-the-rack controller), processor configuration, and Ethernet host communication activity.

SNAP High-Density Digital I/O Modules

Specifications (continued)

	SNAP-ODC-32-SRC SNAP-ODC-32-SRC-FM	SNAP-ODC-32-SNK SNAP-ODC-32-SNK-FM
Switching Voltage	5–60 VDC	5–60 VDC
Nominal Switching Voltage	12–24 VDC	12–24 VDC
Logic Voltage and Current	5 VDC ± 0.1 @ 150 mA	5 VDC ± 0.1 @ 150 mA
Maximum Off State Voltage	60 VDC	60 VDC
Output Leakage, Typical	<10 microamps per channel (60 V, 70 °C)	<10 microamps per channel (60 V, 70 °C)
Maximum Load per Point	0.25 A	0.25 A
Voltage Drop	0.15 VDC @ 0.25 A	0.15 VDC @ 0.25 A
Surge (1 sec.)	1 A	1 A
Output Arrangement	32 output channels; 4 groups of 8 outputs each. Points in each group share a common positive connection.	32 output channels; 4 groups of 8 outputs each. Points in each group share a common negative connection.
Output Turn-On/Off Time	100 microseconds	100 microseconds
Polling time from I/O processor to module ¹	2–30 ms typical ²	2–30 ms typical ²
Indicators	None; use optional OptoTerminal-G20 diagnostic display or breakout rack.	None; use optional OptoTerminal-G20 diagnostic display or breakout rack.
Maximum Number of HDD Modules on One Mounting Rack	16	16
Agency Approvals	SNAP-ODC-32-SRC: UL, CE, RoHS, DFARS SNAP-ODC-32-SRC-FM: CE, FM, RoHS, DFARS	SNAP-ODC-32-SNK: UL, CE, RoHS, DFARS SNAP-ODC-32-SNK-FM: CE, FM, RoHS, DFARS
Torque, hold-down screws	4 in-lb (0.45 N-m)	4 in-lb (0.45 N-m)
Torque, connector screws	5.26 in-lb (0.6 N-m)	5.26 in-lb (0.6 N-m)
Warranty	Lifetime	Lifetime

1 Affects turn-on and turn-off determination

2 Time varies based on the SNAP PAC I/O processor (brain or on-the-rack controller), processor configuration, and Ethernet host communication activity.

SNAP High-Density Digital I/O Modules

Pinouts and Wiring

Pinouts—SNAP-ODC-32-SRC (and -FM) and SNAP-ODC-32-SNK (and -FM) Digital Modules

FUSING

For both sourcing and sinking modules, either fuse each point (as shown in the first and third groups, below) or fuse each group of points (as shown in the second and fourth groups).

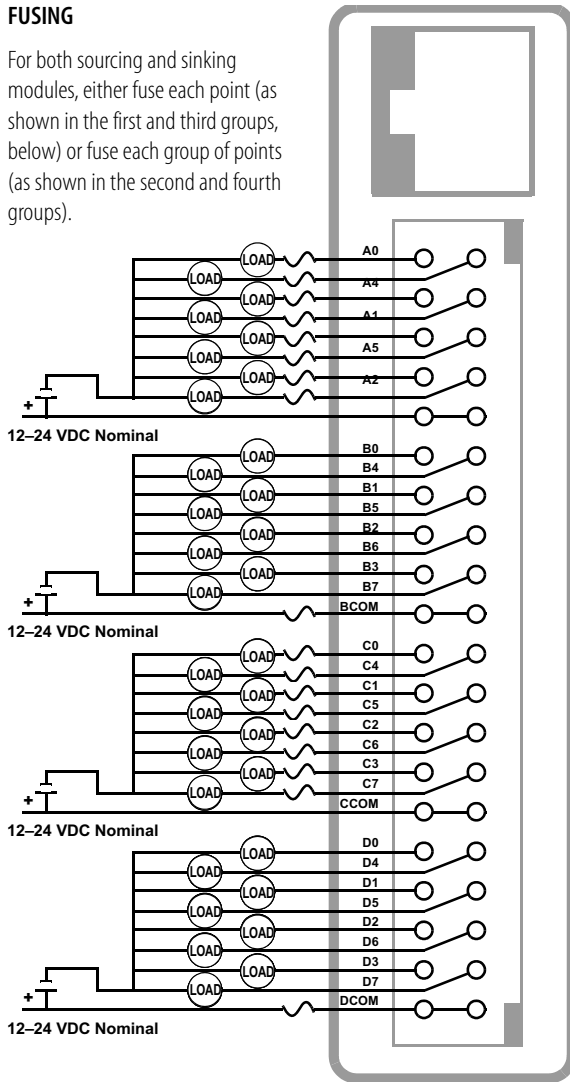

SNAP-ODC-32-SRC
Load Sourcing Module
(Top view of module)

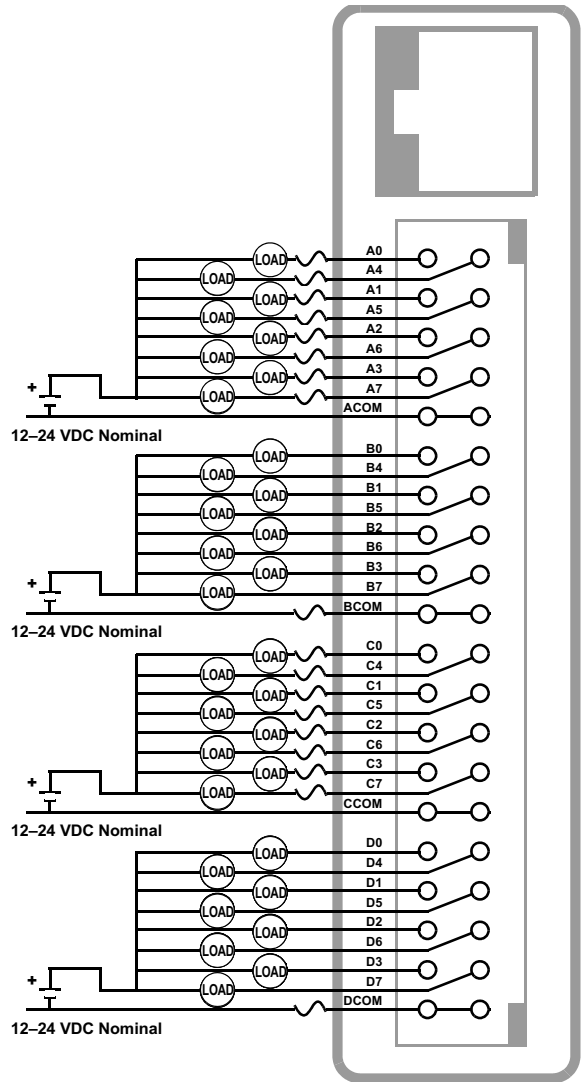

SNAP-ODC-32-SNK
Load Sinking Module
(Top view of module)

NOTE: The SNAP-ODC-32-SRC and SNAP-ODC-32-SNK modules (includes -FM models) have built-in transient suppression for each channel. Additional commutating diodes are not necessary.

SNAP High-Density Digital I/O Modules

Pinouts and Wiring (continued)

Pinouts for SNAP-IDC-32, SNAP-IDC-32-FM, and SNAP-IDC-32N Digital Modules

IMPORTANT: SNAP-IDC-32 modules are polarity specific and must be wired as shown.

Polarity for SNAP-IDC-32N

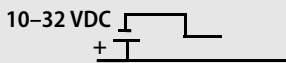
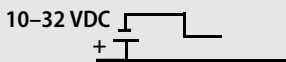
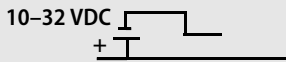
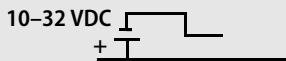

Polarity for SNAP-IDC-32 SNAP-IDC-32-FM

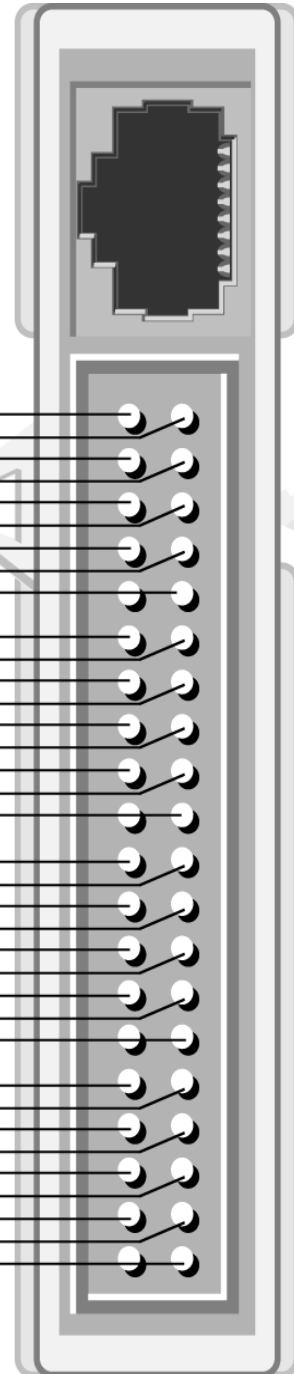
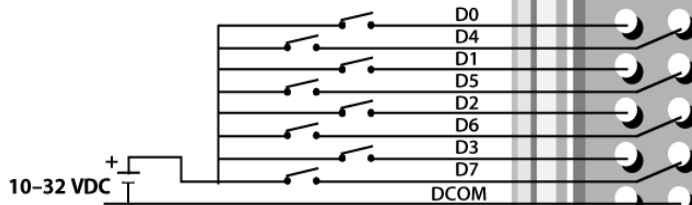
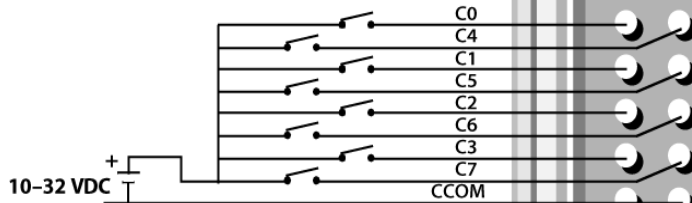
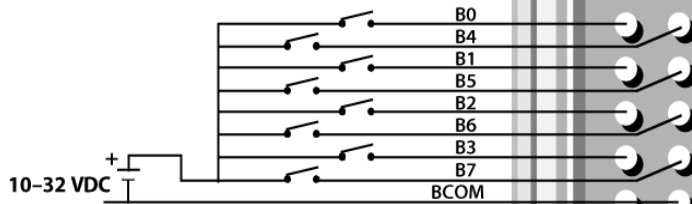
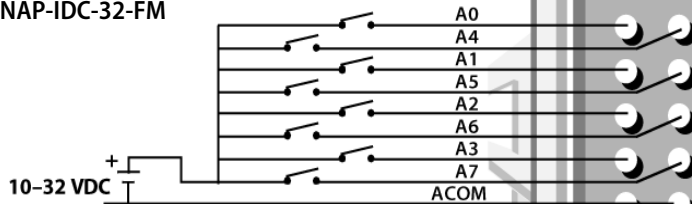

SNAP High-Density Digital I/O Modules

Pinouts and Wiring (continued)

Connector Wiring—SNAP 32-Point Digital Modules

The following diagram shows 32-channel module connector wiring for the SNAP-HD-CBF6 wiring harness. Wires from the

wiring harness are grouped into four sets. Each set contains color-coded wires.

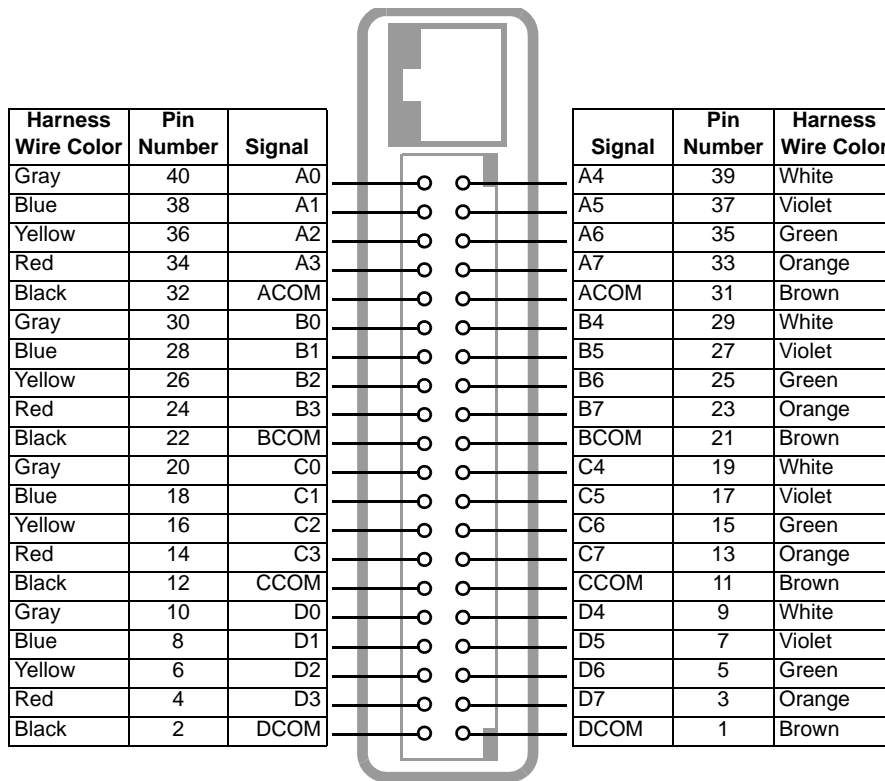

Connector wiring for SNAP-ODC-32-SNK, SNAP-ODC-32-SRC, SNAP-IDC-32, -FM versions, and SNAP-IDC-32N (top view of module)

Building Your Own Wiring Harness or Header Cable for a 32-channel module

To build your own wiring harness similar to the SNAP-HD-CBF6, you will need the following parts:

Connector: Molex 15-04-5401

Pin housing: Molex 50-57-9320

Pins: Molex p/n 16-02-0103

Cable: Alpha 5020/40c (24 AWG, 40 conductor) or equivalent (UL type CM)

To build your own SNAP-HD-BF6 header cable for use with either breakout rack, you will need the parts listed below. Both ends of the cable use the same connectors.

Connector: Molex 15-04-5401

Pin housing: Molex 50-57-9320

Pins: Molex p/n 16-02-0103

Cable: Alpha 5020C or Manhattan M38910 (24 AWG, 10 conductor, 4x length needed) or equivalent (UL type CM)

SNAP High-Density Digital I/O Modules

Pinouts and Wiring (continued)

Pinouts—16-Channel Digital Input Modules

Applies to the SNAP-IDC-16, SNAP-IDC-HT-16, SNAP-IAC-16, SNAP-IAC-A-16, and SNAP-IAC-K-16.

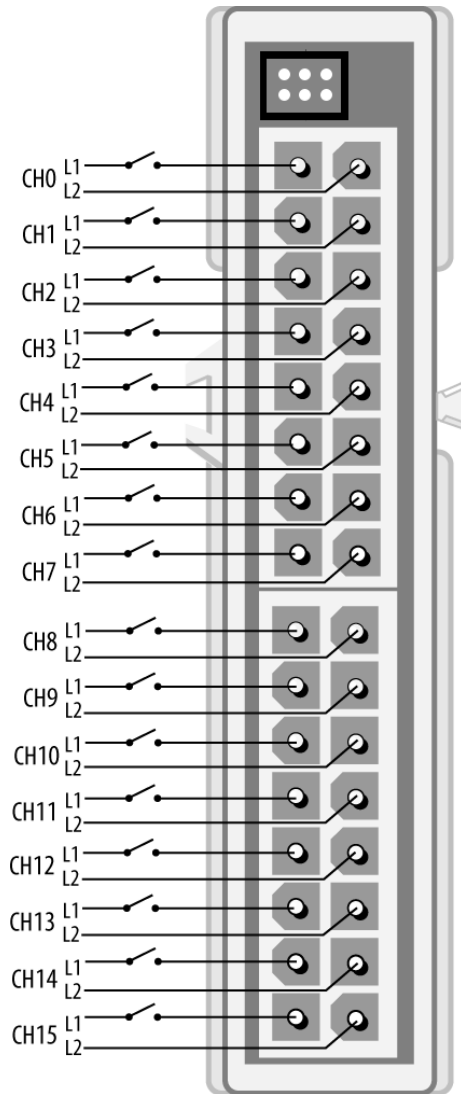

NOTE: The connectors on these modules are not polarity-sensitive. You can connect the positive lead (+) for each channel (or point) to either L1 or L2, and this can vary from point to point on the module.

SNAP High-Density Digital I/O Modules

Pinouts and Wiring (continued)

Connector Wiring—SNAP 16-Point Digital Modules

The following diagram shows 16-channel module connector wiring for the SNAP-HD-ACF6 wiring harness. Applies to SNAP-IDC-16, SNAP-IDC-HT-16, SNAP-IAC-16, SNAP-IAC-A-16, and SNAP-IAC-K-16 high-density digital modules.

NOTE: The small four-pin connector on the top of a 16-point module connects to the optional OptoTerminal-G20 using a special adapter cable, included with the OptoTerminal.

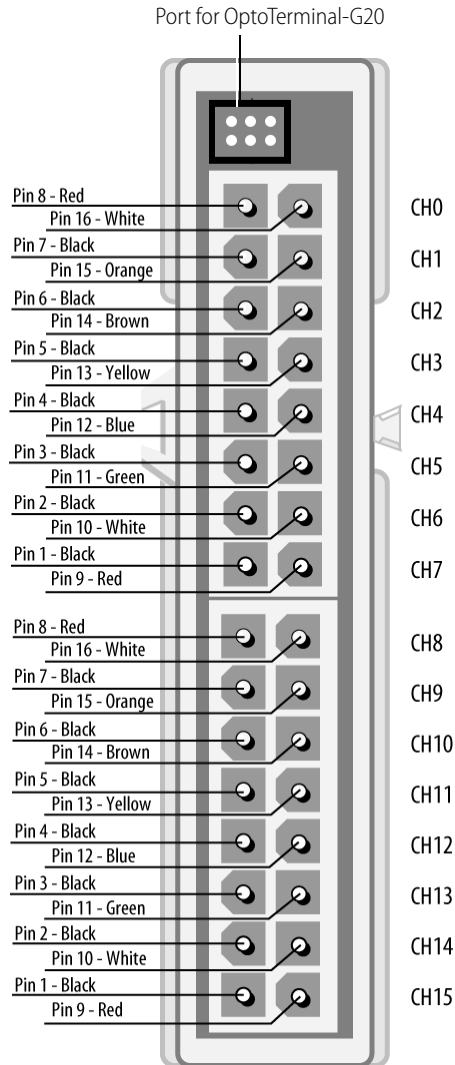

Top View of Module

Building Your Own Wiring Harness for a 16-channel Module

To build your own wiring harness similar to the SNAP-HD-ACF6, you will need the following parts:

Connector: Molex 39-01-2165

Pins: Molex 39-00-0214

Cable: Belden 8308 (22 AWG, 16 conductor, shielded) or equivalent (UL AWM style 2464)

SNAP High-Density Digital I/O Modules

Dimensional Drawings

SNAP 32-Point Digital Modules

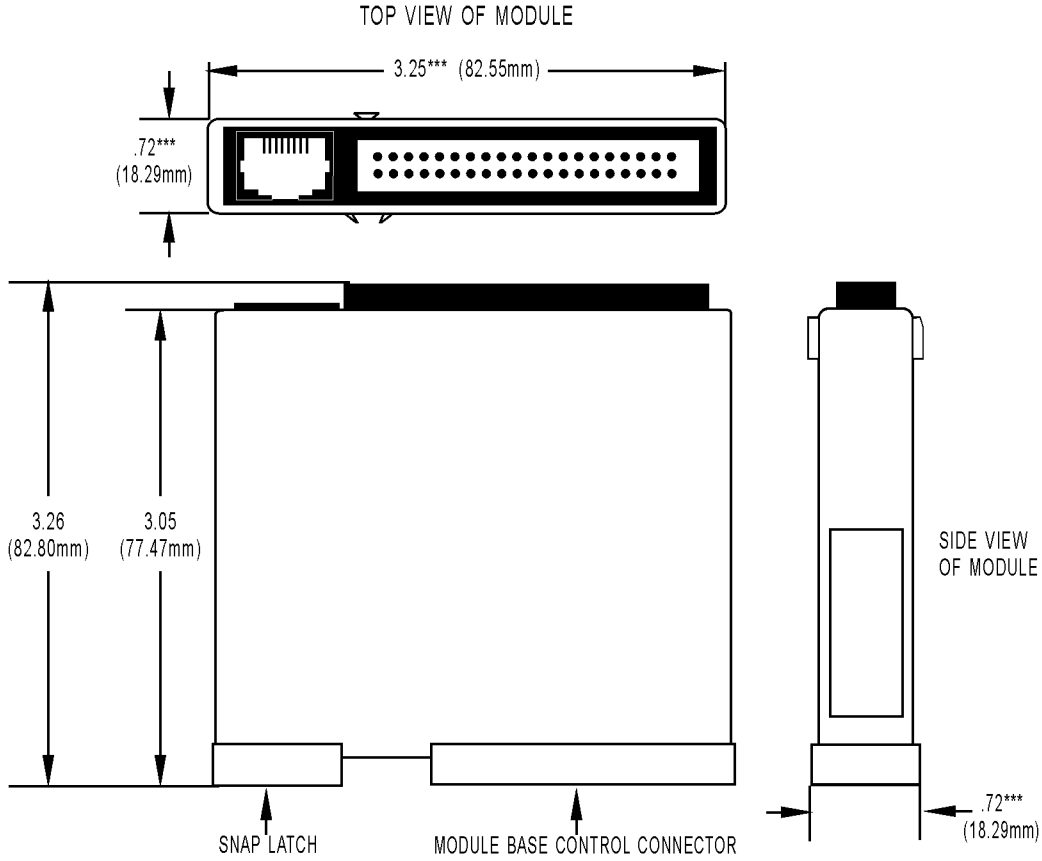

TOLERANCES LEGEND

* +/- .010" ** +/- .020"
 *** +/- .030" **** +/- .060"
 NO * REFERENCE ONLY

SNAP High-Density Digital I/O Modules

Dimensional Drawings (continued)

SNAP 16-Point Digital Modules

TOP VIEW OF MODULE

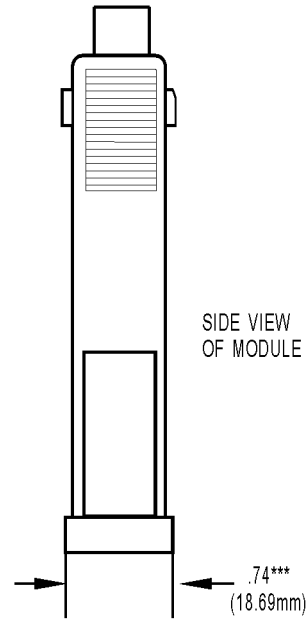
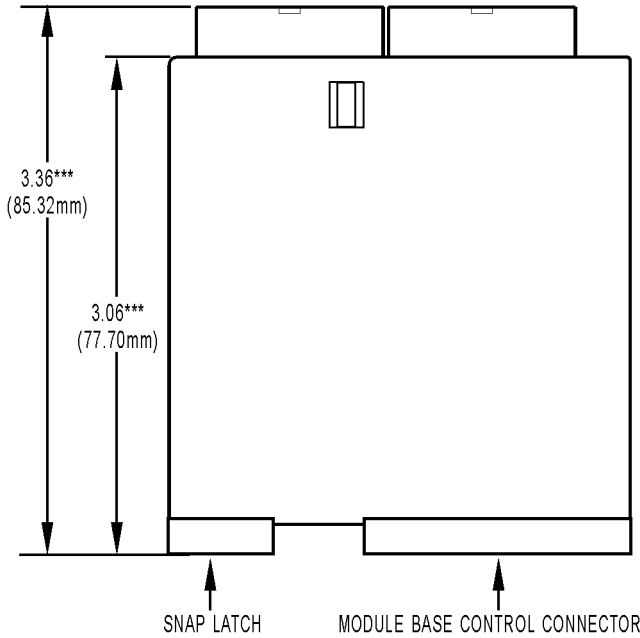
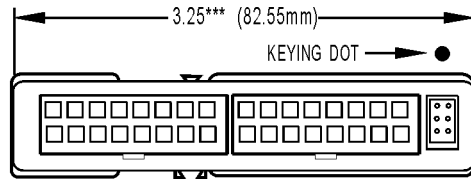

TOLERANCES LEGEND
 * +/- .010" ** +/- .020"
 *** +/- .030" **** +/- .060"
 NO * REFERENCE ONLY

SNAP High-Density Digital I/O Modules

Dimensional Drawings (continued)

SNAP High-Density Digital Modules (All)

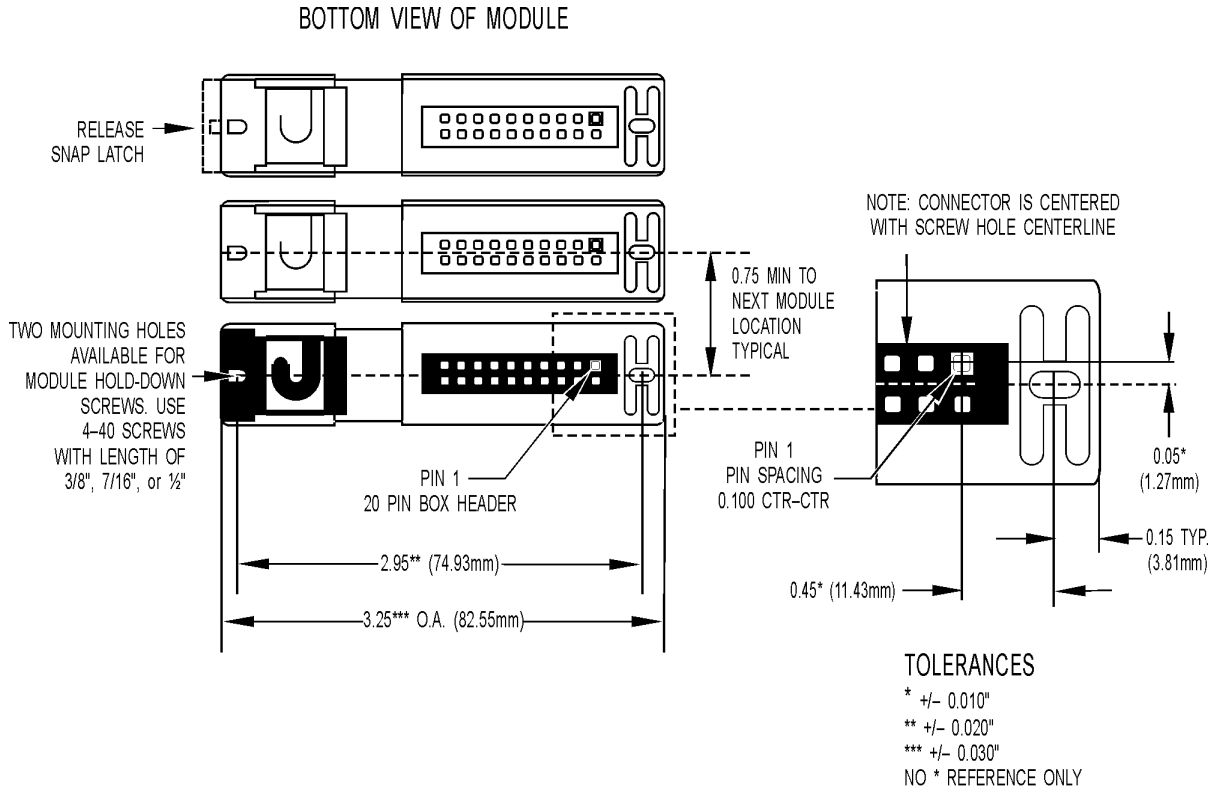

IMPORTANT: The mounting rack connector has 24 pins; the module connector has 20 pins. The extra pins on the mounting rack connector prevent misalignment of the module during installation.

SNAP High-Density Digital I/O Modules

Dimensional Drawings (continued)

SNAP High-Density Digital Modules (All)

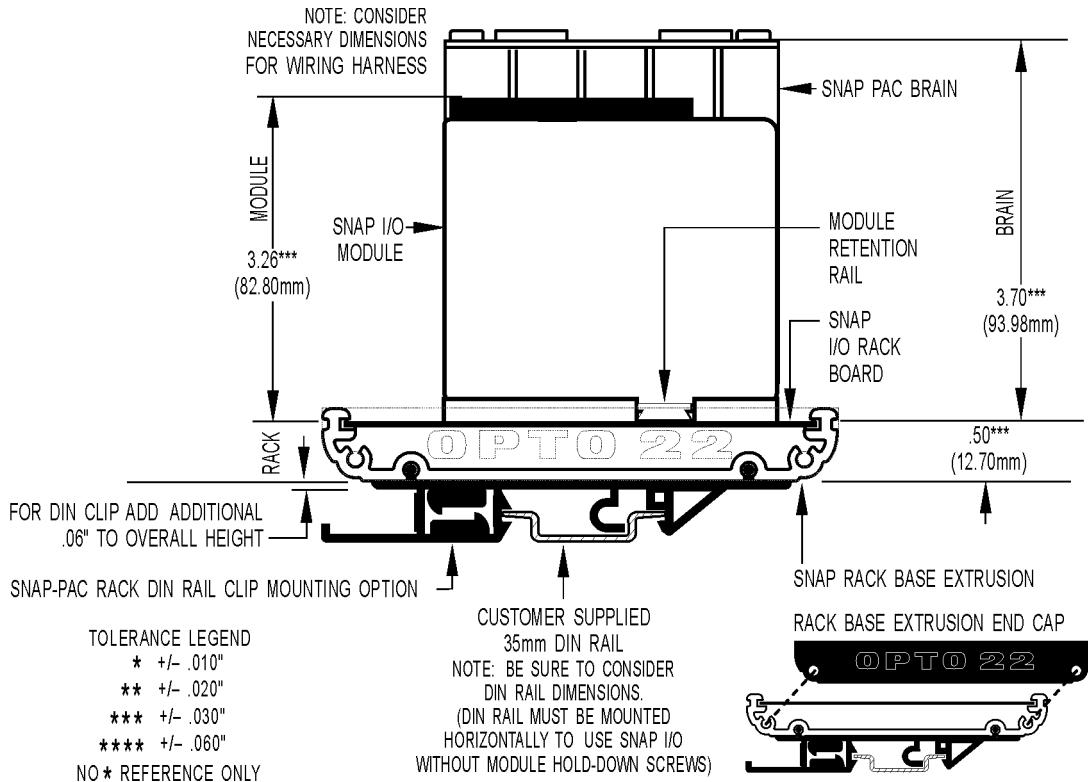

More About Opto 22

Products

Opto 22 develops and manufactures reliable, flexible, easy-to-use hardware and software products for industrial automation, remote monitoring, and data acquisition applications.

SNAP PAC System

Designed to simplify the typically complex process of understanding, selecting, buying, and applying an automation system, the SNAP PAC System consists of four integrated components:

- SNAP PAC controllers
- PAC Project™ Software Suite
- SNAP PAC brains
- SNAP I/O™

SNAP PAC Controllers

Programmable automation controllers (PACs) are multifunctional, multidomain, modular controllers based on open standards and providing an integrated development environment.

Opto 22 has been manufacturing PACs for many years. The latest models include the standalone SNAP PAC S-series and the rack-mounted SNAP PAC R-series. Both handle a wide range of digital, analog, and serial functions and are equally suited to data collection, remote monitoring, process control, and discrete and hybrid manufacturing.

SNAP PACs are based on open Ethernet and Internet Protocol (IP) standards, so you can build or extend a system without the expense and limitations of proprietary networks and protocols.

PAC Project Software Suite

Opto 22's PAC Project Software Suite provides full-featured and cost-effective control programming, HMI (human machine interface) development and runtime, OPC server, and database connectivity software to power your SNAP PAC System.

These fully integrated software applications share a single tagname database, so the data points you configure in PAC Control™ are immediately available for use in PAC Display™, OptoOPCServer™, and OptoDataLink™. Commands are in plain English; variables and I/O point names are fully descriptive.

PAC Project Basic offers control and HMI tools and is free for download on our website, www.opto22.com. PAC Project Professional, available for separate purchase, adds OptoOPCServer, OptoDataLink, options for Ethernet link redundancy or segmented networking, and support for legacy Opto 22 serial *mistic*™ I/O units.

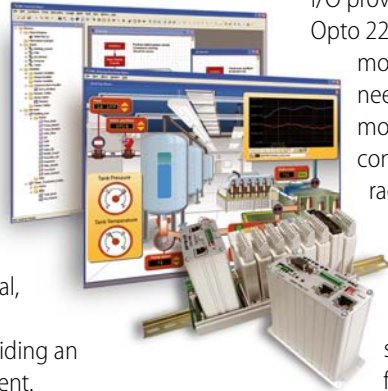

SNAP PAC Brains

While SNAP PAC controllers provide central control and data distribution, SNAP PAC brains provide distributed intelligence for I/O processing and communications. Brains offer analog, digital, and serial functions, including thermocouple linearization; PID loop control; and optional high-speed digital counting (up to 20 kHz), quadrature counting, TPO, and pulse generation and measurement.

SNAP I/O

I/O provides the local connection to sensors and equipment. Opto 22 SNAP I/O offers 1 to 32 points of reliable I/O per module, depending on the type of module and your needs. Analog, digital, serial, and special-purpose modules are all mixed on the same mounting rack and controlled by the same processor (SNAP PAC brain or rack-mounted controller).

Quality

Founded in 1974 and with over 85 million devices sold, Opto 22 has established a worldwide reputation for high-quality products. All are made in the U.S.A. at our manufacturing facility in Temecula, California. Because we do no statistical testing and each part is tested twice before leaving our factory, we can guarantee most solid-state relays and optically isolated I/O modules for life.

Free Product Support

Opto 22's Product Support Group offers free, comprehensive technical support for Opto 22 products. Our staff of support engineers represents decades of training and experience. Product support is available in English and Spanish, by phone or email, Monday through Friday, 7 a.m. to 5 p.m. PST.

Free Customer Training

Hands-on training classes for the SNAP PAC System are offered at our headquarters in Temecula, California. Each student has his or her own learning station; classes are limited to nine students. Registration for the free training class is on a first-come, first-served basis. See our website, www.opto22.com, for more information or email training@opto22.com.

Purchasing Opto 22 Products

Opto 22 products are sold directly and through a worldwide network of distributors, partners, and system integrators. For more information, contact Opto 22 headquarters at 800-321-6786 or 951-695-3000, or visit our website at www.opto22.com.

www.opto22.com