

CLEAN TRAY™ Stainless Steel Cable Tray

Straight Section



Straight sections are available in 10-ft. lengths with or without perforations. Available with a 20-degree sloped cover in some sizes. One U-connector and hardware is supplied with each straight section.

Bulletin: F23

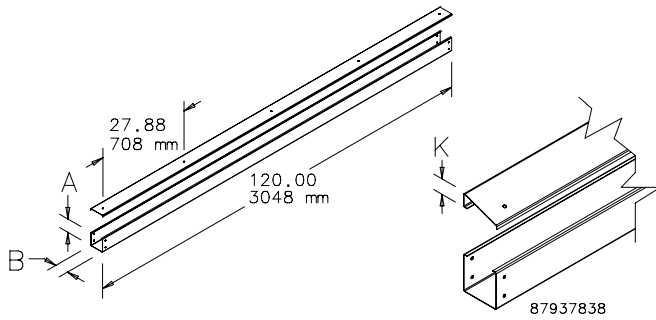

Catalog Number	AxB in./mm	Description	K in./mm
CT22120SS	2.00 x 2.00 51 x 51	Standard	—
CT33120SS	3.00 x 3.00 76 x 76	Standard	—
CT44120SS	4.00 x 4.00 102 x 102	Standard	—
CT46120SS	4.00 x 6.00 102 x 152	Standard	—
CT66120SS	6.00 x 6.00 152 x 152	Standard	—
CT22P120SS	2.00 x 2.00 51 x 51	Perforated	—
CT33P120SS	3.00 x 3.00 76 x 76	Perforated	—
CT44P120SS	4.00 x 4.00 102 x 102	Perforated	—
CT46P120SS	4.00 x 6.00 102 x 152	Perforated	—
CT66P120SS	6.00 x 6.00 152 x 152	Perforated	—
CTS33120SS	3.00 x 3.00 76 x 76	Sloped Top	1.06 24
CTS44120SS	4.00 x 4.00 102 x 102	Sloped Top	1.42 36
CTS46120SS	4.00 x 6.00 102 x 152	Sloped Top	2.16 55
CTS66120SS	6.00 x 6.00 152 x 152	Sloped Top	2.16 55
CTS33P120SS	3.00 x 3.00 76 x 76	Sloped Top Perforated	1.06 27
CTS44P120SS	4.00 x 4.00 102 x 102	Sloped Top Perforated	1.42 36
CTS46P120SS	4.00 x 6.00 102 x 152	Sloped Top Perforated	2.16 55
CTS66P120SS	6.00 x 6.00 152 x 152	Sloped Top Perforated	2.16 55

Divider Straight Section

Used to divide one straight section into two sections.

Bulletin: F23

Catalog Number	AxB in./mm	Fits Cable Tray Size in./mm	L in./mm
CT33DSS	3.00 x 3.00	4.00 x 4.00	2.13
	76 x 76	102 x 102	54
CT44DSS	4.00 x 4.00	4.00 x 6.00	3.13
	102 x 102	102 x 152	79
CT66DSS	6.00 x 6.00	6.00 x 6.00	5.13
	152 x 152	152 x 152	130

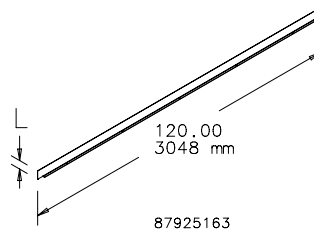

Telescopic Straight Section



Adjusts from 18.74 in. to 30.61 in.

Bulletin: F23

Catalog Number	AxB in.	AxB mm
CT22TSS	2.00 x 2.00	51 x 51
CT33TSS	3.00 x 3.00	76 x 76
CT44TSS	4.00 x 4.00	102 x 102
CT46TSS	4.00 x 6.00	102 x 152
CT66TSS	6.00 x 6.00	152 x 152

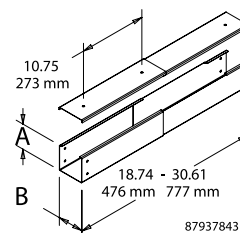

Divider, Telescopic Straight Section

Must be trimmed to length.

Bulletin: F23

Catalog Number	AxB in.	AxB mm
CT33TDSPSS	3.00 x 3.00	76 x 76
CT44TDSPSS	4.00 x 4.00	102 x 102
CT66TDSPSS	6.00 x 6.00	152 x 152

90-Degree Elbows

Used wherever a 90-degree transition is required. Models without tabs connect directly to another elbow without using a splice.

Bulletin: F23

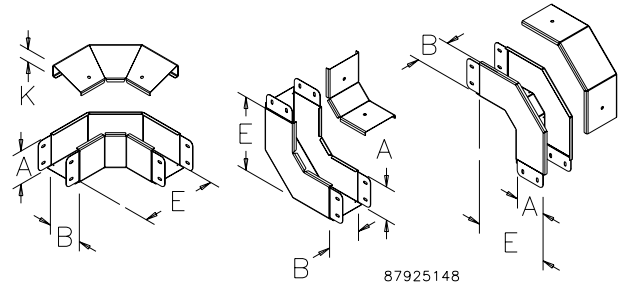

Catalog Number	AxB in.	AxB mm	Description	E (in.)	E (mm)	K (in.)	K (mm)
CT22EFC90SS	2.00 x 2.00	51 x 51	Front Cover	6.00	152	—	—
CT33EFC90SS	3.00 x 3.00	76 x 76	Front Cover	7.00	178	—	—
CT44EFC90SS	4.00 x 4.00	102 x 102	Front Cover	9.00	229	—	—
CT46EFC90SS	4.00 x 6.00	102 x 152	Front Cover	11.00	279	—	—
CT66EFC90SS	6.00 x 6.00	152 x 152	Front Cover	11.00	279	—	—
CT22EFCNT90SS	2.00 x 2.00	51 x 51	Front Cover without Tabs	6.00	152	—	—
CT33EFCNT90SS	3.00 x 3.00	76 x 76	Front Cover without Tabs	7.00	178	—	—
CT44EFCNT90SS	4.00 x 4.00	102 x 102	Front Cover without Tabs	9.00	229	1.42	36
CT46EFCNT90SS	4.00 x 6.00	102 x 152	Front Cover without Tabs	11.00	279	2.16	55
CT66EFCNT90SS	6.00 x 6.00	152 x 152	Front Cover without Tabs	11.00	279	2.16	55
CT22EIC90SS	2.00 x 2.00	51 x 51	Inside Cover	6.00	152	—	—
CT33EIC90SS	3.00 x 3.00	76 x 76	Inside Cover	7.00	178	—	—
CT44EIC90SS	4.00 x 4.00	102 x 102	Inside Cover	9.00	229	—	—
CT46EIC90SS	4.00 x 6.00	102 x 152	Inside Cover	11.00	279	—	—
CT66EIC90SS	6.00 x 6.00	152 x 152	Inside Cover	11.00	279	—	—
CT22E0C90SS	2.00 x 2.00	51 x 51	Outside Cover	6.00	152	—	—
CT33E0C90SS	3.00 x 3.00	76 x 76	Outside Cover	7.00	178	—	—
CT44E0C90SS	4.00 x 4.00	102 x 102	Outside Cover	9.00	229	—	—
CT46E0C90SS	4.00 x 6.00	102 x 152	Outside Cover	11.00	279	—	—
CT66E0C90SS	6.00 x 6.00	152 x 152	Outside Cover	11.00	279	—	—
CT22PEFC90SS	2.00 x 2.00	51 x 51	Front Cover Perforated	6.00	152	—	—
CT33PEFC90SS	3.00 x 3.00	76 x 76	Front Cover Perforated	7.00	178	—	—
CT44PEFC90SS	4.00 x 4.00	102 x 102	Front Cover Perforated	9.00	229	—	—
CT46PEFC90SS	4.00 x 5.00	102 x 127	Front Cover Perforated	11.00	279	—	—
CT66PEFC90SS	6.00 x 5.00	152 x 127	Front Cover Perforated	11.00	279	—	—
CTS33EFC90SS	3.00 x 3.00	76 x 76	Front Cover Sloped Inward	7.00	178	1.06	27
CTS44EFC90SS	4.00 x 4.00	102 x 102	Front Cover Sloped Inward	9.00	229	1.42	36
CTS46EFC90SS	4.00 x 6.00	102 x 152	Front Cover Sloped Inward	11.00	279	2.16	55
CTS66EFC90SS	6.00 x 6.00	152 x 152	Front Cover Sloped Inward	11.00	279	2.16	55
CTS33PEFC90SS	3.00 x 3.00	76 x 76	Front Cover Sloped Inward Perforated	7.00	178	1.06	27
CTS44PEFC90SS	4.00 x 4.00	102 x 102	Front Cover Sloped Inward Perforated	9.00	229	1.42	36
CTS46PEFC90SS	4.00 x 6.00	102 x 152	Front Cover Sloped Inward Perforated	11.00	279	2.16	55
CTS66PEFC90SS	6.00 x 6.00	152 x 152	Front Cover Sloped Inward Perforated	11.00	279	2.16	55

CLEAN TRAY™ Stainless Steel Cable Tray

90-Degree Elbows—Perforated without Tabs



Used wherever a 90-degree transition is required.

Bulletin: F23

Catalog Number	AxB in.	AxB mm	E (in.)	E (mm)
CT22PEFCNT90SS	2.00 x 2.00	51 x 51	6.00	152
CT33PEFCNT90SS	3.00 x 3.00	76 x 76	7.00	178
CT44PEFCNT90SS	4.00 x 4.00	102 x 102	9.00	229
CT46PEFCNT90SS	4.00 x 6.00	102 x 152	11.00	279
CT66PEFCNT90SS	6.00 x 6.00	152 x 152	11.00	279

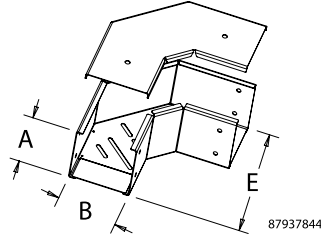

90-Degree Elbows—Front Cover Sloped Inward without Tabs



Used wherever a 90-degree transition is required.

Bulletin: F23

Catalog Number	AxB in./mm	E in./mm	K in./mm
CTS44EFCNT90SS	4.00 x 4.00	9.00	1.42
	102 x 102	229	36
CTS46EFCNT90SS	4.00 x 6.00	11.00	2.16
	102 x 152	279	55
CTS66EFCNT90SS	6.00 x 6.00	11.00	2.16
	152 x 152	279	55

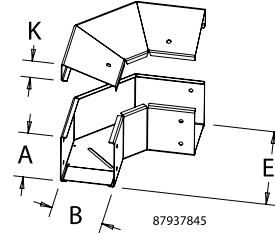

90-Degree Elbows—Front Cover Sloped Outward with Tabs



Used wherever a 90-degree transition is required.

Bulletin: F23

Catalog Number	AxB in./mm	E in./mm	K in./mm
CTS44EFC090SS	4.00 x 4.00	9.00	1.42
	102 x 102	229	36
CTS46EFC090SS	4.00 x 6.00	11.00	2.16
	102 x 152	279	55
CTS66EFC090SS	6.00 x 6.00	11.00	2.16
	152 x 152	279	55

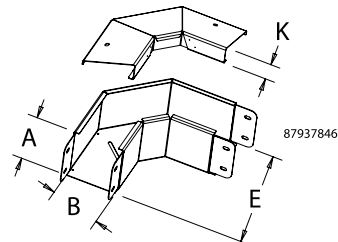

90-Degree Elbows—Front Cover Sloped Outward without Tabs



Used wherever a 90-degree transition is required.

Bulletin: F23

Catalog Number	AxB in./mm	E in./mm	K in./mm
CTS44EFCONT90SS	4.00 x 4.00 102 x 102	9.00 229	1.42 36
CTS46EFCONT90SS	4.00 x 6.00 102 x 152	11.00 279	2.16 55
CTS66EFCONT90SS	6.00 x 6.00 152 x 152	11.00 279	2.16 55

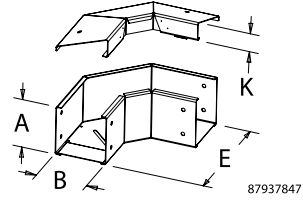

90-Degree Elbows—Inside Cover Sloped



Used wherever a 90-degree transition is required.

Bulletin: F23

Catalog Number	AxB in./mm	E in./mm	K in./mm
CTS44EIC90SS	4.00 x 4.00 102 x 102	9.00 229	1.42 36
CTS46EIC90SS	4.00 x 6.00 102 x 152	11.00 279	2.16 55
CTS66EIC90SS	6.00 x 6.00 152 x 152	11.00 279	2.16 55

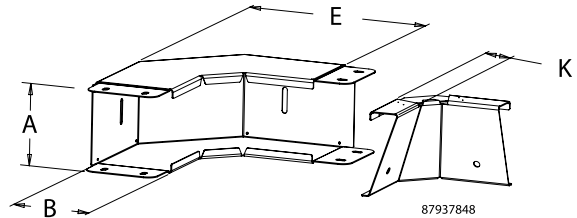

90-Degree Elbows—Outside Cover Sloped



Used wherever a 90-degree transition is required.

Bulletin: F23

Catalog Number	AxB in./mm	E in./mm	K in./mm
CTS44E0C90SS	4.00 x 4.00 102 x 102	9.00 229	1.42 36
CTS46E0C90SS	4.00 x 6.00 102 x 152	11.00 279	2.16 55
CTS66E0C90SS	6.00 x 6.00 152 x 152	11.00 279	2.16 55

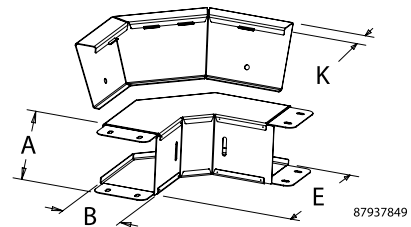

CLEAN TRAY™ Stainless Steel Cable Tray

45-Degree Elbows

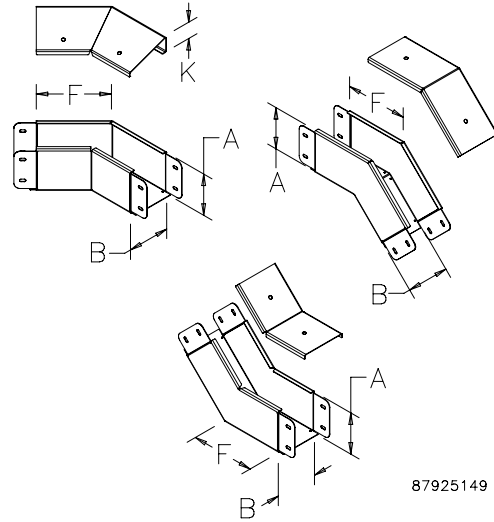

87925149

Used wherever a 45-degree transition is required.

Bulletin: F23

Catalog Number	AxB in.	AxB mm	Description	F (in.)	F (mm)	K (in.)	K (mm)
CT22EFC45SS	2.00 x 2.00	51 x 51	Front Cover	4.57	116	—	—
CT33EFC45SS	3.00 x 3.00	76 x 76	Front Cover	4.98	127	—	—
CT44EFC45SS	4.00 x 4.00	102 x 102	Front Cover	5.96	151	—	—
CT46EFC45SS	4.00 x 6.00	102 x 152	Front Cover	6.79	173	—	—
CT66EFC45SS	6.00 x 6.00	152 x 152	Front Cover	6.79	173	—	—
CT22EIC45SS	2.00 x 2.00	51 x 51	Inside Cover	4.57	116	—	—
CT33EIC45SS	3.00 x 3.00	76 x 76	Inside Cover	4.98	127	—	—
CT44EIC45SS	4.00 x 4.00	102 x 102	Inside Cover	5.96	151	—	—
CT46EIC45SS	4.00 x 6.00	102 x 152	Inside Cover	6.79	173	—	—
CT66EIC45SS	6.00 x 6.00	152 x 152	Inside Cover	6.79	173	—	—
CT22E0C45SS	2.00 x 2.00	51 x 51	Outside Cover	4.57	116	—	—
CT33E0C45SS	3.00 x 3.00	76 x 76	Outside Cover	4.98	127	—	—
CT44E0C45SS	4.00 x 4.00	102 x 102	Outside Cover	5.96	151	—	—
CT46E0C45SS	4.00 x 6.00	102 x 152	Outside Cover	6.79	173	—	—
CT66E0C45SS	6.00 x 6.00	152 x 152	Outside Cover	6.79	173	—	—
CT22PEFC45SS	2.00 x 2.00	51 x 51	Front Cover Perforated	4.57	116	—	—
CT33PEFC45SS	3.00 x 3.00	76 x 76	Front Cover Perforated	4.98	127	—	—
CT44PEFC45SS	4.00 x 4.00	102 x 102	Front Cover Perforated	5.96	151	—	—
CT46PEFC45SS	4.00 x 6.00	102 x 152	Front Cover Perforated	6.79	173	—	—
CT66PEFC45SS	6.00 x 6.00	152 x 152	Front Cover Perforated	6.79	173	—	—
CTS33EFC45SS	3.00 x 3.00	76 x 76	Front Cover Sloped	4.98	127	1.06	27
CTS44EFC45SS	4.00 x 4.00	102 x 102	Front Cover Sloped	5.96	151	1.42	36
CTS46EFC45SS	4.00 x 6.00	102 x 152	Front Cover Sloped	6.79	173	2.16	55
CTS66EFC45SS	6.00 x 6.00	152 x 152	Front Cover Sloped	6.79	173	2.16	55
CTS33PEFC45SS	3.00 x 3.00	76 x 76	Front Cover Sloped Perforated	4.98	127	1.06	27
CTS44PEFC45SS	4.00 x 4.00	102 x 102	Front Cover Sloped Perforated	5.96	151	1.42	36
CTS46PEFC45SS	4.00 x 6.00	102 x 152	Front Cover Sloped Perforated	6.79	173	2.16	55
CTS66PEFC45SS	6.00 x 6.00	152 x 152	Front Cover Sloped Perforated	6.79	173	2.16	55

45-Degree Elbows—Front Cover Sloped Outward



Catalog Number	AxB in./mm	F in./mm	K in./mm
CTS44EFC045SS	4.00 x 4.00	5.96	1.42
	102 x 102	151	36
CTS46EFC045SS	4.00 x 6.00	6.79	2.16
	102 x 152	173	55
CTS66EFC045SS	6.00 x 6.00	6.79	2.16
	152 x 152	173	55

Used wherever a 45-degree transition is required.

Bulletin: F23

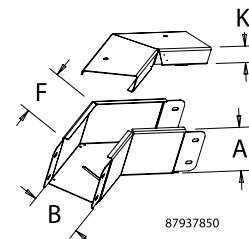

87937850

45-Degree Elbows—Inside Cover Sloped



Used wherever a 45-degree transition is required.

Bulletin: F23

Catalog Number	AxB in./mm	F in./mm	K in./mm
CTS44EIC45SS	4.00 x 4.00 102 x 102	5.96 151	1.42 36
CTS46EIC45SS	4.00 x 6.00 102 x 152	6.79 173	2.16 55
CTS66EIC45SS	6.00 x 6.00 152 x 152	6.79 173	2.16 55

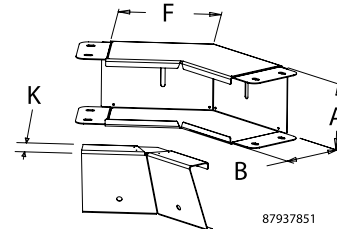

45-Degree Elbows—Outside Cover Sloped



Used wherever a 45-degree transition is required.

Bulletin: F23

Catalog Number	AxB in./mm	F in./mm	K in./mm
CTS44E0C45SS	4.00 x 4.00 102 x 102	5.96 151	1.42 36
CTS46E0C45SS	4.00 x 6.00 102 x 152	6.79 173	2.16 55
CTS66E0C45SS	6.00 x 6.00 152 x 152	6.79 173	2.16 55

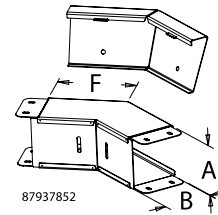

Variable-Angle Elbow Fitting



Adjustable from 0 to 90 degrees. Simplifies and saves field integration and installation time.

Bulletin: F23

Catalog Number	AxB in.	AxB mm
CT22VSS	2.00 x 2.00	51 x 51
CT33VSS	3.00 x 3.00	76 x 76
CT44VSS	4.00 x 4.00	102 x 102
CT46VSS	4.00 x 6.00	102 x 152
CT66VSS	6.00 x 6.00	152 x 152

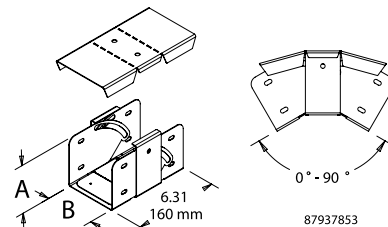

CLEAN TRAY™ Stainless Steel Cable Tray

90-Degree Tee

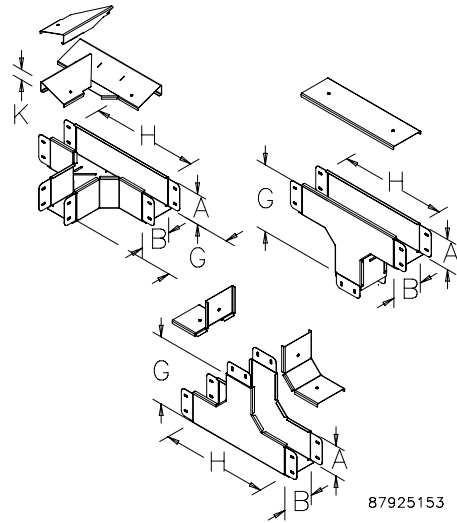

87925153

Available with or without perforations in three cover options: front, inside and outside. Used wherever two 90-degree transitions are required. Available with a 20-degree sloped cover in some sizes (Front Cover only).

Bulletin: F23

Catalog Number	AxB in.	AxB mm	Description	G (in.)	G (mm)	H (in.)	H (mm)	K (in.)	K (mm)
CT22TFCSS	2.00 x 2.00	51 x 51	Front Cover	3.00	152	10.00	254	—	—
CT33TFCSS	3.00 x 3.00	76 x 76	Front Cover	9.00	229	14.00	356	—	—
CT44TFCSS	4.00 x 4.00	102 x 102	Front Cover	7.00	178	11.00	279	—	—
CT46TFCSS	4.00 x 6.00	102 x 152	Front Cover	11.00	279	16.00	406	—	—
CT66TFCSS	6.00 x 6.00	152 x 152	Front Cover	11.00	279	16.00	406	—	—
CT33TICSS	3.00 x 3.00	76 x 76	Inside Cover	7.00	178	11.00	279	—	—
CT44TICSS	4.00 x 4.00	102 x 102	Inside Cover	9.00	229	14.00	356	—	—
CT46TICSS	4.00 x 6.00	102 x 152	Inside Cover	11.00	279	16.00	406	—	—
CT66TICSS	6.00 x 6.00	152 x 152	Inside Cover	11.00	279	16.00	406	—	—
CT22TOCSS	2.00 x 2.00	51 x 51	Outside Cover	6.00	152	10.00	254	—	—
CT33TOCSS	3.00 x 3.00	76 x 76	Outside Cover	7.00	178	11.00	279	—	—
CT44TOCSS	4.00 x 4.00	102 x 102	Outside Cover	9.00	229	14.00	356	—	—
CT46TOCSS	4.00 x 6.00	102 x 152	Outside Cover	11.00	279	16.00	406	—	—
CT66TOCSS	6.00 x 6.00	152 x 152	Outside Cover	11.00	279	16.00	406	—	—
CT22PTFCSS	2.00 x 2.00	51 x 51	Front Cover Perforated	6.00	152	10.00	254	—	—
CT33PTFCSS	3.00 x 3.00	76 x 76	Front Cover Perforated	7.00	178	11.00	279	—	—
CT44PTFCSS	4.00 x 4.00	102 x 102	Front Cover Perforated	9.00	229	14.00	356	—	—
CT46PTFCSS	4.00 x 6.00	102 x 152	Front Cover Perforated	11.00	279	16.00	406	—	—
CT66PTFCSS	6.00 x 6.00	152 x 152	Front Cover Perforated	11.00	279	16.00	406	—	—
CTS33TFCSS	3.00 x 3.00	76 x 76	Front Cover Sloped	7.00	178	11.00	279	1.06	27
CTS44TFCSS	4.00 x 4.00	102 x 102	Front Cover Sloped	9.00	229	14.00	356	1.42	36
CTS46TFCSS	4.00 x 6.00	102 x 152	Front Cover Sloped	11.00	279	16.00	406	2.16	55
CTS66TFCSS	6.00 x 6.00	152 x 152	Front Cover Sloped	11.00	279	16.00	406	2.16	55
CTS33PTFCSS	3.00 x 3.00	76 x 76	Front Cover Sloped Perforated	7.00	178	11.00	279	1.06	27
CTS44PTFCSS	4.00 x 4.00	102 x 102	Front Cover Sloped Perforated	9.00	229	14.00	356	1.42	36
CTS46PTFCSS	4.00 x 6.00	102 x 152	Front Cover Sloped Perforated	11.00	279	16.00	406	2.16	55
CTS66PTFCSS	6.00 x 6.00	152 x 152	Front Cover Sloped Perforated	11.00	279	16.00	406	2.16	55

CLEAN TRAY™ Stainless Steel Cable Tray

90-Degree Tee—Front Cover Sloped Outward



Used wherever two 90-degree transitions are required.

Bulletin: F23

Catalog Number	AxB in.	AxB mm	K (in.)	K (mm)
CTS44TFCOSS	4.00 x 4.00	102 x 102	1.42	36
CTS46TFCOSS	4.00 x 6.00	102 x 152	2.16	55
CTS66TFCOSS	6.00 x 6.00	152 x 152	2.16	55

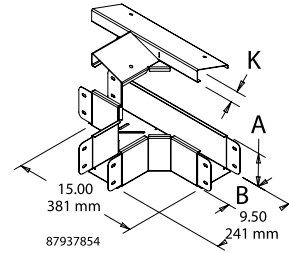

90-Degree Tee—Inside Cover Sloped



Used wherever two 90-degree transitions are required.

Bulletin: F23

Catalog Number	AxB in.	AxB mm	K (in.)	K (mm)
CTS44TICSS	4.00 x 4.00	102 x 102	1.42	36
CTS46TICSS	4.00 x 6.00	102 x 152	2.16	55
CTS66TICSS	6.00 x 6.00	152 x 152	2.16	55

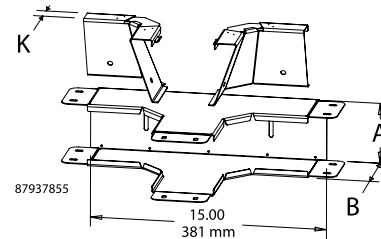

90-Degree Tee—Outside Cover Sloped



Used wherever two 90-degree transitions are required.

Bulletin: F23

Catalog Number	AxB in.	AxB mm	G (in.)	G (mm)	K (in.)	K (mm)
CTS44TOCSS	4.00 x 4.00	102 x 102	9.00	229	1.42	36
CTS46TOCSS	4.00 x 6.00	102 x 152	11.00	279	2.16	55
CTS66TOCSS	6.00 x 6.00	152 x 152	11.00	279	2.16	55

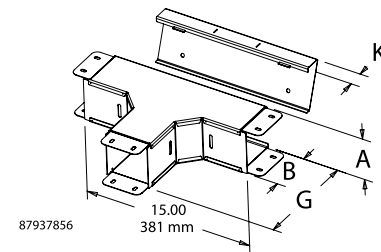

CLEAN TRAY™ Stainless Steel Cable Tray

Cross

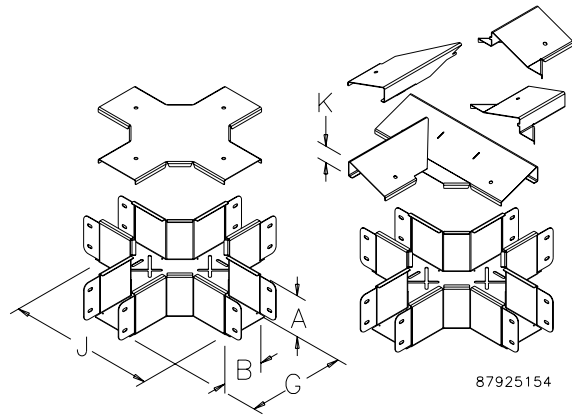

87925154

Available with or without perforations. Used where there are four branches. Available with 20-degree sloped cover in some sizes. Kit includes both left and right sloped covers to create any configuration.

Bulletin: F23

Catalog Number	AxB in.	AxB mm	Description	G (in.)	G (mm)	J (in.)	J (mm)	K (in.)	K (mm)
CT22CSS	2.00 x 2.00	51 x 51	Standard	6.00	152	10	254	—	—
CT33CSS	3.00 x 3.00	76 x 76	Standard	7.00	178	11.00	279	—	—
CT44CSS	4.00 x 4.00	102 x 102	Standard	9.00	229	14.00	356	—	—
CT46CSS	4.00 x 6.00	102 x 152	Standard	11.00	279	16.00	406	—	—
CT66CSS	6.00 x 6.00	152 x 152	Standard	11.00	279	16.00	406	—	—
CT22PCSS	2.00 x 2.00	51 x 51	Perforated	6.00	152	10.00	254	—	—
CT33PCSS	3.00 x 3.00	76 x 76	Perforated	7.00	178	11.00	279	—	—
CT44PCSS	4.00 x 4.00	102 x 102	Perforated	9.00	229	14.00	356	—	—
CT46PCSS	4.00 x 6.00	102 x 152	Perforated	11.00	279	16.00	406	—	—
CT66PCSS	6.00 x 6.00	152 x 152	Perforated	11.00	279	16.00	406	—	—
CTS33CSS	3.00 x 3.00	76 x 76	Sloped Top	7.00	178	11.00	279	1.06	27
CTS44CSS	4.00 x 4.00	102 x 102	Sloped Top	9.00	229	14.00	356	1.42	36
CTS46CSS	4.00 x 6.00	102 x 152	Sloped Top	11.00	279	16.00	406	2.16	55
CTS66CSS	6.00 x 6.00	152 x 152	Sloped Top	11.00	279	16.00	406	2.16	55
CTS33PCSS	3.00 x 3.00	76 x 76	Sloped Top Perforated	7.00	178	11.00	279	1.06	27
CTS44PCSS	4.00 x 4.00	102 x 102	Sloped Top Perforated	9.00	229	14.00	356	1.42	36
CTS46PCSS	4.00 x 6.00	102 x 152	Sloped Top Perforated	11.00	279	16.00	406	2.16	55
CTS66PCSS	6.00 x 6.00	152 x 152	Sloped Top Perforated	11.00	279	16.00	406	2.16	55

Divider 90-Degree Tee



Used to divide a 90-degree tee into two sections.

Bulletin: F23

Catalog Number	AxB in.	AxB mm	Fits Cable		Description	L (in.)	L (mm)
			Tray Size	Tray Size			
CT33DTFCSS	3.00 x 3.00	76 x 76	3 x 3	3 x 3	Front Cover	2.13	54
CT44DTFCSS	4.00 x 4.00	102 x 102	4 x 4	4 x 4	Front Cover	3.13	79
CT46DTFCSS	4.00 x 6.00	102 x 152	4 x 6	4 x 6	Front Cover	3.13	79
CT66DTFCSS	6.00 x 6.00	152 x 152	6 x 6	6 x 6	Front Cover	5.13	130
CT33DTICSS	3.00 x 3.00	76 x 76	3 x 3	3 x 3	Inside Cover	2.13	54
CT44DTICSS	4.00 x 4.00	102 x 102	4 x 4	4 x 4	Inside Cover	3.13	79
CT66DTICSS	6.00 x 6.00	152 x 152	6 x 6	6 x 6	Inside Cover	5.13	130
CT33DTCSS	3.00 x 3.00	76 x 76	3 x 3	3 x 3	Outside Cover	2.13	54
CT44DTCSS	4.00 x 4.00	102 x 102	4 x 4	4 x 4	Outside Cover	3.13	79
CT66DTCSS	6.00 x 6.00	152 x 152	6 x 6	6 x 6	Outside Cover	5.13	130

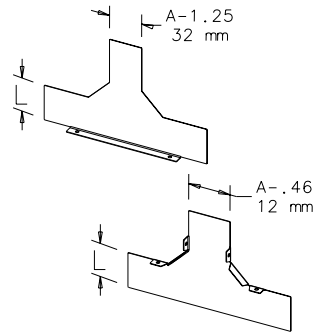

87925167

CLEAN TRAY™ Stainless Steel Cable Tray

Divider 90-Degree Elbow



Used to divide a 90-degree elbow into two sections.

Bulletin: F23

Catalog Number	AxB in.	AxB mm	Description	Fits Cable		
				Tray Size	L (in.)	L (mm)
CT33DEFC90SS	3.00 x 3.00	76 x 76	Front Cover	3 x 3	2.13	54
CT44DEFC90SS	4.00 x 4.00	102 x 102	Front Cover	4 x 4	3.13	79
CT46DEFC90SS	4.00 x 6.00	102 x 152	Front Cover	4 x 6	3.13	79
CT66DEFC90SS	6.00 x 6.00	152 x 152	Front Cover	6 x 6	5.13	130
CT33DEIC90SS	3.00 x 3.00	76 x 76	Inside Cover	3 x 3	2.13	54
CT44DEIC90SS	4.00 x 4.00	102 x 102	Inside Cover	4 x 4, 4 x 6	3.13	79
CT66DEIC90SS	6.00 x 6.00	152 x 152	Inside Cover	6 x 6	5.13	130
CT33DEOC90SS	3.00 x 3.00	76 x 76	Outside Cover	3 x 3	2.13	54
CT44DEOC90SS	4.00 x 4.00	102 x 102	Outside Cover	4 x 4, 4 x 6	3.13	79
CT66DEOC90SS	6.00 x 6.00	152 x 152	Outside Cover	6 x 6	5.13	130

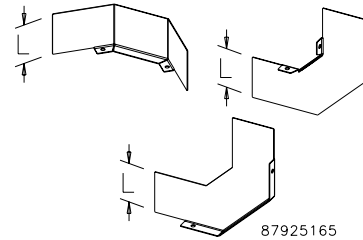

Divider 45-Degree Elbow



Used to divide a 45-degree elbow into two sections.

Bulletin: F23

Catalog Number	AxB in.	AxB mm	Description	Fits Cable		
				Tray Size	L (in.)	L (mm)
CT33DEFC45SS	3.00 x 3.00	76 x 76	Front Cover	3 x 3	2.13	54
CT44DEFC45SS	4.00 x 4.00	102 x 102	Front Cover	4 x 4	3.13	79
CT46DEFC45SS	4.00 x 6.00	102 x 152	Front Cover	4 x 6	3.13	79
CT66DEFC45SS	6.00 x 6.00	152 x 152	Front Cover	6 x 6	5.13	130
CT33DEIC45SS	3.00 x 3.00	76 x 76	Inside Cover	3 x 3	2.13	54
CT44DEIC45SS	4.00 x 4.00	102 x 102	Inside Cover	4 x 4, 4 x 6	3.13	79
CT66DEIC45SS	6.00 x 6.00	152 x 152	Inside Cover	6 x 6	5.13	130
CT33DEOC45SS	3.00 x 3.00	76 x 76	Outside Cover	3 x 3	2.13	54
CT44DEOC45SS	4.00 x 4.00	102 x 102	Outside Cover	4 x 4, 4 x 6	3.13	79
CT66DEOC45SS	6.00 x 6.00	152 x 152	Outside Cover	6 x 6	5.13	130

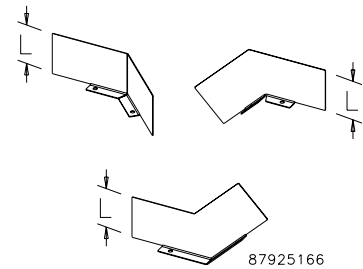

CLEAN TRAY™ Stainless Steel Cable Tray

U-Connector



Used to connect two straight sections.

Bulletin: F23

Catalog Number	AxB in./mm
CT22UCSS	2.00 x 2.00 51 x 51
CT33UCSS	3.00 x 3.00 76 x 76
CT44UCSS	4.00 x 4.00 102 x 102
CT46UCSS	4.00 x 6.00 102 x 152
CT66UCSS	6.00 x 6.00 152 x 152

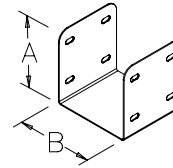

87925155

Closure Plate



Closes the end of a cable tray section or run. Available with 20-degree slope in some sizes (left slope shown).

Bulletin: F23

Catalog Number	AxB in.	AxB mm	Description	K (in.)	K (mm)
CT22CPSS	2.00 x 2.00	51 x 51	Standard	—	—
CT33CPSS	3.00 x 3.00	76 x 76	Standard	—	—
CT44CPSS	4.00 x 4.00	102 x 102	Standard	—	—
CT46CPSS	4.00 x 6.00	102 x 152	Standard	—	—
CT66CPSS	6.00 x 6.00	152 x 152	Standard	—	—
CTS33CPRS	3.00 x 3.00	76 x 76	Sloped Right	1.06	27
CTS33CPLS	3.00 x 3.00	76 x 76	Sloped Left	1.06	27
CTS44CPRS	4.00 x 4.00	102 x 102	Sloped Right	1.42	36
CTS44CPLS	4.00 x 4.00	102 x 102	Sloped Left	1.42	36
CTS46CPRS	4.00 x 6.00	102 x 152	Sloped Right	2.16	55
CTS46CPLS	4.00 x 6.00	102 x 152	Sloped Left	2.16	55
CTS66CPRS	6.00 x 6.00	152 x 152	Sloped Right	2.16	55
CTS66CPLS	6.00 x 6.00	152 x 152	Sloped Left	2.16	55

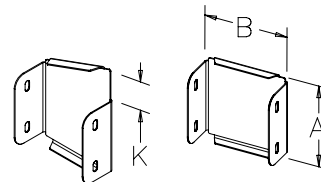

87925156

Enclosure Adapter



Allows the cable tray to be securely connected to an enclosure.

Bulletin: F23

Catalog Number	AxB in./mm
CT22AESS	2.00 x 2.00 51 x 51
CT33AESS	3.00 x 3.00 76 x 76
CT44AESS	4.00 x 4.00 102 x 102
CT46AESS	4.00 x 6.00 102 x 152
CT66AESS	6.00 x 6.00 152 x 152

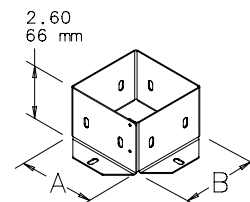

87925157

CLEAN TRAY™ Stainless Steel Cable Tray

Reducer

Used to reduce to a smaller size cable tray. Available with 20-degree slope in some sizes (right slope shown).

Bulletin: F23

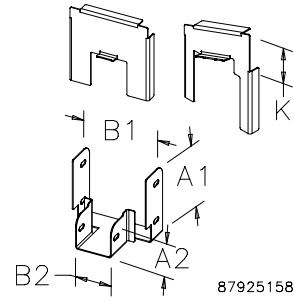
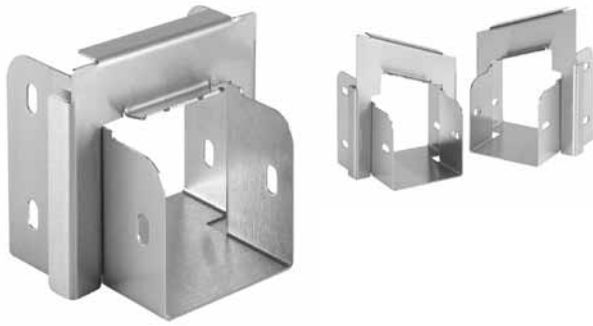

87925158

Catalog Number	AxB in.	AxB mm	Description	A2 (in.)	A2 (mm)	B2 (in.)	B2 (mm)	K (in.)	K (mm)
CT3322RSS	3.00 x 3.00	76 x 76	3 x 3 2 x 2 Standard	2.00	51	2.00	51	—	—
CT4433RSS	4.00 x 4.00	102 x 102	4 x 4 3 x 3 Standard	3.00	76	3.00	76	—	—
CT4422RSS	4.00 x 4.00	102 x 102	4 x 4 2 x 2 Standard	2.00	51	2.00	51	—	—
CT4644RSS	4.00 x 6.00	102 x 152	4 x 6 4 x 4 Standard	4.00	102	4.00	102	—	—
CT4633RSS	4.00 x 6.00	102 x 152	4 x 6 3 x 3 Standard	3.00	76	3.00	76	—	—
CT6622RSS	6.00 x 6.00	152 x 152	6 x 6 2 x 2 Standard	2.00	51	2.00	51	—	—
CT6646RSS	6.00 x 6.00	152 x 152	6 x 6 4 x 6 Standard	4.00	102	6.00	152	—	—
CT6644RSS	6.00 x 6.00	152 x 152	6 x 6 4 x 4 Standard	4.00	102	4.00	102	—	—
CT6633RSS	6.00 x 6.00	152 x 152	6 x 6 3 x 3 Standard	3.00	76	3.00	76	—	—
CTS4433RRSS	4.00 x 4.00	102 x 102	4 x 4 3 x 3 Sloped Right	3.00	76	3.00	76	1.42	36
CTS4433RLSS	4.00 x 4.00	102 x 102	4 x 4 3 x 3 Sloped Left	3.00	76	3.00	76	1.42	36
CTS4644RRSS	4.00 x 6.00	102 x 152	4 x 6 4 x 4 Sloped Right	4.00	102	4.00	102	2.16	55
CTS4644RLSS	4.00 x 6.00	102 x 152	4 x 6 4 x 4 Sloped Left	4.00	102	4.00	102	2.16	55
CTS4633RRSS	4.00 x 6.00	102 x 152	4 x 6 3 x 3 Sloped Right	3.00	76	3.00	76	2.16	55
CTS4633RLSS	4.00 x 6.00	102 x 152	4 x 6 3 x 3 Sloped Left	3.00	76	3.00	76	2.16	55
CTS6646RRSS	6.00 x 6.00	152 x 152	6 x 6 4 x 6 Sloped Right	4.00	102	6.00	152	2.16	55
CTS6646RLSS	6.00 x 6.00	152 x 152	6 x 6 4 x 6 Sloped Left	4.00	102	6.00	152	2.16	55
CTS6644RRSS	6.00 x 6.00	152 x 152	6 x 6 4 x 4 Sloped Right	4.00	102	4.00	102	2.16	55
CTS6644RLSS	6.00 x 6.00	152 x 152	6 x 6 4 x 4 Sloped Left	4.00	102	4.00	102	2.16	55
CTS6633RRSS	6.00 x 6.00	152 x 152	6 x 6 3 x 3 Sloped Right	3.00	76	3.00	76	2.16	55
CTS6633RLSS	6.00 x 6.00	152 x 152	6 x 6 3 x 3 Sloped Left	3.00	76	3.00	76	2.16	55

Cable Exit Cover



Covers cables that exit the side of the cable tray. Will cover a keyhole or slot used to pass the cable through.

Bulletin: F23

Catalog Number	T in./mm
CT2233CEC	1.50 38
CT4466CEC	3.00 76

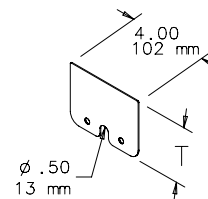

87925159

CLEAN TRAY™ Stainless Steel Cable Tray

Straight Section Splice



Used to connect two fittings with tabs. Available with 20-degree slope in some sizes.

Bulletin: F23

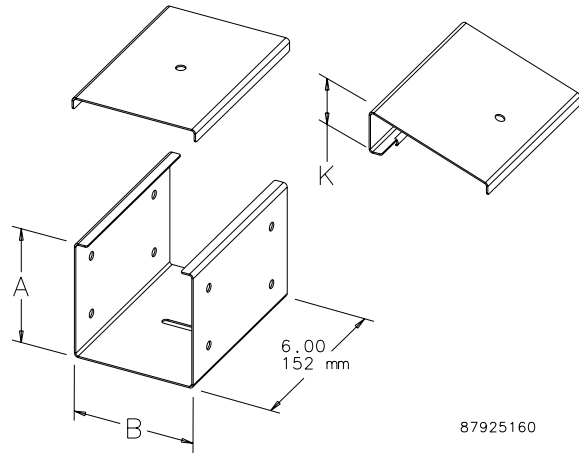

87925160

Catalog Number	AxB in.	AxB mm	Description	K (in.)	K (mm)
CT22SPSS	2.00 x 2.00	51 x 51	Standard	—	—
CT33SPSS	3.00 x 3.00	76 x 76	Standard	—	—
CT44SPSS	4.00 x 4.00	102 x 102	Standard	—	—
CT46SPSS	4.00 x 6.00	102 x 152	Standard	—	—
CT66SPSS	6.00 x 6.00	152 x 152	Standard	—	—
CT22SPSSS	2.00 x 2.00	51 x 51	Perforated	—	—
CT33SPSSS	3.00 x 3.00	76 x 76	Perforated	—	—
CT44SPSSS	4.00 x 4.00	102 x 102	Perforated	—	—
CT46SPSSS	4.00 x 6.00	102 x 152	Perforated	—	—
CT66SPSSS	6.00 x 6.00	152 x 152	Perforated	—	—
CTS33SPSS	3.00 x 3.00	76 x 76	Sloped Top	1.06	27
CTS44SPSS	4.00 x 4.00	102 x 102	Sloped Top	1.42	36
CTS46SPSS	4.00 x 6.00	102 x 152	Sloped Top	2.16	55
CTS66SPSS	6.00 x 6.00	152 x 152	Sloped Top	2.16	55
CTS33SPSSS	3.00 x 3.00	76 x 76	Sloped Top Perforated	1.06	27
CTS44SPSSS	4.00 x 4.00	102 x 102	Sloped Top Perforated	1.42	36
CTS46SPSSS	4.00 x 6.00	102 x 152	Sloped Top Perforated	2.16	55
CTS66SPSSS	6.00 x 6.00	152 x 152	Sloped Top Perforated	2.16	55

Divider Straight Section Splice



Used to divide a straight section splice into two sections.

Bulletin: F23

Catalog Number	AxB in./mm	Fits Cable Tray Size	L in./mm
CT33DSPSS	3.00 x 3.00	3 x 3	2.13
	76 x 76		54
CT44DSPSS	4.00 x 4.00	4 x 4, 4 x 6	3.13
	102 x 102		79
CT66DSPSS	6.00 x 6.00	6 x 6	5.13
	152 x 152		130

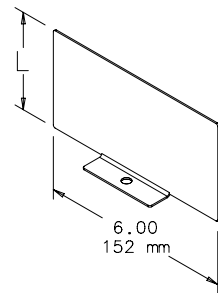

87925164

Transition Cover



Transitions from a sloped to standard cable tray. Available with right- and left-hand slope. Will fit the Splice (order separately) or anywhere on a straight section (transition cover sloped to flat left-hand shown in drawing).

Bulletin: F23

Catalog Number	Description	Fits Cable Tray Size	B in./mm	K in./mm
CTS33TCRSS	Transition Cover Sloped to Flat Right Hand	3 x 3	3.00 76	1.06 27
CTS33TCLSS	Transition Cover Sloped to Flat Left Hand	3 x 3	3.00 76	1.06 27
CTS44TCRSS	Transition Cover Sloped to Flat Right Hand	4 x 4	4.00 102	1.42 36
CTS44TCLSS	Transition Cover Sloped to Flat Left Hand	4 x 4	4.00 102	1.42 36
CTS46TCRSS	Transition Cover Sloped to Flat Right Hand	4 x 6, 6 x 6	6.00 152	2.16 55
CTS46TCLSS	Transition Cover Sloped to Flat Left Hand	4 x 6, 6 x 6	6.00 152	2.16 55

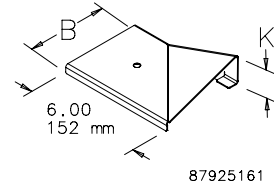

Side Coupling

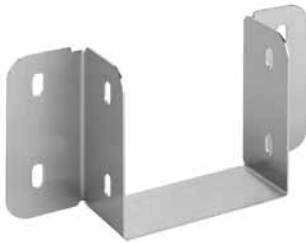

Used to connect straight sections or fittings to the side of a cable tray run. A cutout will be required in the side of the cable tray.

Bulletin: F23

Catalog Number	AxB in.	AxB mm
CT22SCSS	2.00 x 2.00	51 x 51
CT33SCSS	3.00 x 3.00	76 x 76
CT44SCSS	4.00 x 4.00	102 x 102
CT46SCSS	4.00 x 6.00	102 x 152
CT66SCSS	6.00 x 6.00	152 x 152

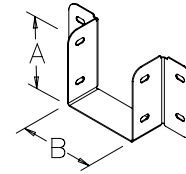

Fastener Package

1/4-20 stainless steel fasteners used to connect cable tray components.

Bulletin: F23

Catalog Number	Screws	Nuts
CT1420SS	100	100

Hanger Bracket

Used to support a cable tray run.

Bulletin: F23

Catalog Number	AxB in./mm	M in./mm	Pkg. Qty.
CT22HB	2.00 x 2.00	3.58	20
	51 x 51	91	
CT33HB	3.00 x 3.00	4.58	20
	76 x 76	116	
CT44HB	4.00 x 4.00	5.58	20
	102 x 102	142	
CT66HB	6.00 x 6.00	7.58	20
	152 x 152	193	

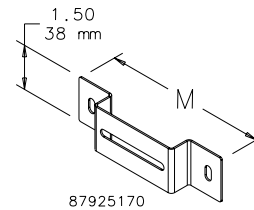

CLEAN TRAY™ Stainless Steel Cable Tray

L-Bracket

Used to support a cable tray run. Can be mounted to a vertical UNISTRUT® channel.

UNISTRUT is a registered trademark of Unistrut Corporation.

Bulletin: F23

Catalog Number	AxB in./mm	N in./mm	P in./mm	Pkg. Qty.
CT22LB	2.00 x 2.00	3.00	3.64	20
	51 x 51	76	92	
CT33LB	3.00 x 3.00	4.00	4.64	20
	76 x 76	102	118	
CT44LB	4.00 x 4.00	5.00	5.64	20
	102 x 102	127	143	
CT66LB	6.00 x 6.00	7.64	7.64	20
	152 x 152	194	194	

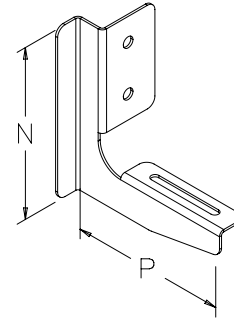

87925169

Wall Bracket

Used to support a cable tray run.

Bulletin: F23

Catalog Number	AxB in./mm	R in./mm	S in./mm	Pkg. Qty.
CT22WB	2.00 x 2.00	1.55	2.25	20
	51 x 51	39	57	
CT33WB	3.00 x 3.00	2.55	3.25	20
	76 x 76	65	83	
CT44WB	4.00 x 4.00	3.55	4.25	20
	102 x 102	90	108	
CT66WB	6.00 x 6.00	5.55	6.25	20
	152 x 152	141	159	

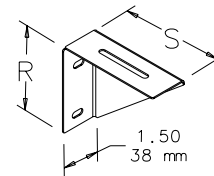

87925168

Latch Hardware Kits

Bulletin: F23

Catalog Number	Use on (in.)	Use on (mm)
CTLCHSS	2.00 x 2.00, 4.00 x 6.00, 6.00 x 6.00	51 x 51, 102 x 152, 152 x 152
CTLCH3SS	3.00 x 3.00	76 x 76
CTLCH4SS	4.00 x 4.00	102 x 102
CTSLSHSS	Sloped	—