

Metal Clad Cable, Armored Cable and Flexible Metal Conduit Fittings

Metal Clad Cable, Armored Cable and Flexible Metal Conduit

Armored Cable (Type AC) — Ref. NEC Article 320

National Electrical Code defines type AC armored cable as, "A fabricated assembly of insulated conductors in a flexible metallic enclosure."

ACT	Indicates an armored cable employing conductors having thermoplastic (Type T) insulation.
AC	Indicates an armored cable employing conductors having rubber insulation of code grade.
ACH	Indicates an armored cable employing conductors having rubber insulation of the heat resistant (75° C) grade.
ACHH	Indicates an armored cable employing conductors having rubber insulation of the heat resistant (90° C) grade.
ACU	Indicates an armored cable employing conductors having rubber insulation of latex grade.
"L"	Used as a suffix, it indicates that a lead covering has been applied over the conductor assembly.

All armored cables may employ copper or aluminum or copperclad aluminum conductors with the following sizes and are rated for 600 volts or less:

- No. 14 AWG to No. 1 AWG Copper
- No. 12 AWG to No. 1 AWG Aluminum or Copperclad Aluminum

Type AC cables except ACL carry an internal bonding strip of copper or aluminum in intimate contact with the armor for its entire length. Armored cable can be used for both exposed or concealed locations. With lead-covered conductors (Type ACL), the cable can be embedded in masonry or concrete and can be used in damp locations or where exposed to oil.

Armored cable is not permitted in locations where it will be subjected to physical damage or corrosive fumes. Armored cable cannot be used for direct burial in earth.

With minor exceptions, armored cable is also not permitted to be used in hoists or elevators, storage battery rooms, any hazardous locations, in commercial garages and in theaters or similar locations.

Codes require that cable shall be supported with straps or staples without damaging conductors and also limit the minimum bend radius to 5 times the diameter of type AC cable. Certain precautions are prescribed in code where cable is installed through joist rafters or similar wood members.

According to NEC 320 where armored cable is terminated, a fitting is required to protect conductors from abrasion. In addition, a bushing is required between the conductors and armor. Design of fitting has to be such that the insulating bushing is visible for inspection. Bushing is not required with lead-covered cables when properly installed.

Portions of this section reprinted by permission from NFPA 70–2005, National Electrical Code®, Copyright © 2004, National Fire Protection Association, Boston, MA.

Please refer to the following for further details and complete information:

1. NEC Article 320...Armored Cable (Type AC Cable)
2. UL 4, ANSI C33.9...Safety Standards for Armored Cable
3. UL 514B, Safety Standards for Outlet Boxes and Fittings
4. A-A-50552...Federal Specification. Fittings for Cable, Power, Electrical and Conduit, Metal, Flexible
5. NEMA FB-1...Standards Publication. Fittings & Supports for Conduit and Cable Assemblies
6. CEC Section 12-700...Wiring Methods (Armored Cable)
7. CSA C22.2 No. 51...Safety Standards for Armored Cables
8. CSA C22.2 No. 18...Safety Standards for Outlet Boxes, Conduit Boxes and Fittings

NOTE

The materials herein, whether relating to the National Electrical Code, the Underwriters Laboratories, Inc. listing, to industry practice or otherwise, are not intended to provide all relevant information required for use and installation of our products. Refer to applicable codes, instructions and industry specifications prior to installation or use.

Metal Clad Cable, Armored Cable and Flexible Metal Conduit Fittings

Metal Clad Cable, Armored Cable and Flexible Metal Conduit — continued

Flexible Metal Conduit — Ref. NEC Article 348

Flexible metal conduit can be used for exposed or concealed work in dry locations. It can be used for wet locations provided conductors within are lead covered or other approved type.

Flexible metal conduit cannot be used underground or embedded in poured concrete or aggregate. With rubber covered conductors, the conduit cannot be exposed to oil, gasoline or other materials having a deteriorating effect on rubber.

With minor exceptions use of flexible metal conduit is not permitted in hoists, in storage battery rooms and in any hazardous locations. Use of flexible metal conduit is restricted to systems under 600 volts.

According to NEC Article 350-5, flexible metal conduit no longer than six feet and containing circuit conductors protected by overcurrent device rated for 20 amps or less is suitable as a grounding means provided, it is terminated in fittings approved for the purpose.

Flexible metal conduit longer than six feet is permitted to be used as a grounding means provided the conduit and the fitting are approved for the purpose. To date, there is no flexible metal conduit approved for the purpose by the Underwriters Laboratories.

In Class I & II, Division 2 hazardous areas, the conduit itself cannot be used as the grounding means. A bonding jumper must be installed in accordance with NEC Section 250.102. Flexible metal conduit is available with steel or aluminum armor in trade size 3/8" to 4". With few exceptions where 3/8" and 3/4" trade sizes are used, Code prohibits use of conduit less than d" trade size. Bends in concealed work are restricted to 360 degrees total. No angle connectors are permitted in concealed raceway installations.

Portions of this section reprinted by permission from NFPA 70-2005, National Electrical Code®, Copyright © 2004, National Fire Protection Association, Boston, MA.

Please refer to the following for further details and complete information:

1. NEC Article 348...Flexible Metal Conduit
2. UL 1, ANSI C33.92...Safety Standards for Flexible Metal Conduit
3. UL 514B, Safety Standards for Outlet Boxes and Fittings
4. A-A-50552...Federal Specification. Fittings for Cable, Power, Electrical and Conduit, Metal Flexible
5. WW-C-566...Federal Specification. Conduit, Metal, Flexible
6. NEMA FB1...Standards Publication. Fittings and Supports for Conduit and Cable Assemblies
7. CEC 12-1100...Wiring Method (Rigid & Flexible Conduit)
8. CSA C22.2 No. 56...Safety Standards for Flexible Metallic Conduit and Liquid-Tight Flexible Metal Conduit
9. CSA C22.2 No. 18...Safety Standards for Outlet Boxes, Conduit Boxes and Fittings

T&B Fittings

Suggested Specifications for Armored Cable and Flexible Metal Conduit Fittings



Series 3110
Armored Cable Connector &
Flexible Metal Conduit



Series 422
Insuliner® Sleeve

- Armored cable (metal clad cable type AC) and flexible metal conduit shall conform to provisions of following applicable standards:

Armored Cable...UL 4/ANSI C33.9/CSA 22.2 No. 51

Flexible Metal Conduit...UL 1/ANSI C33.92/WW-C-566/CSA 22.2 No. 56

Type of cable used and conductors within flexible metal conduit shall be suitable for conditions of use and location.

- Where approved armored cable or flexible metal conduit is used as an equipment grounding conductor, terminating fitting used shall be of the grounding type as manufactured by Thomas & Betts, series 3110

- Where armored cable or flexible metal conduit terminates into a threadless or threaded opening, it shall be assembled with approved fittings; fittings shall be of malleable iron/steel construction, electro zinc plated inside outside, equipped with nylon insulated throat and shall be of angled saddle type as manufactured by Thomas & Betts, series 3110. Direct bearing screw type fittings shall not be used

- Suitable bushing as manufactured by Thomas & Betts, series 422 or 390, shall be provided between the conductors and armor

Metal Clad Cable, Armored Cable and Flexible Metal Conduit Fittings



Armored Cable & Flexible Metal Conduit Connectors



3110 Series

Application

- To connect and effectively bond armored cable or flexible metal conduit to a box or an enclosure

Features

- Provided with a saddle designed to:
 - Firmly secure conduit in place without damaging cable armor (Mechanical holding power of angled wedge assembly increases with increased strain.)
 - Provide high quality bond between conduit or cable and is unaffected by vibrations
 - Centralize conduit or cable with respect to throat opening for conductors
- Insulated throat protects conductors during and after installation, reduces wire pull effort and prevents thread damage in handling
- Locknuts designed to provide effective bond between connector and box or enclosure, will not vibrate loose
- Designed with fewer screws — reduces installation time and cost
- Armor stop with viewing window
- Rugged all steel or malleable iron construction
- Suitable as a grounding means per NEC Article 348 for flexible metal conduit, NEC Article 320 for armored cable and NEC Article 330 for metal clad cable
- Suitable for hazardous location use per Class 1 Division 2 NEC 501.10 (b)(2)

Standard Material/Finish

Body	Steel or malleable iron/ Electro Zinc Plated & Chromate Coated
Saddle	Steel/Electro Zinc Plated & Chromate Coated
Screws	Steel/Electro Zinc Plated & Chromate Coated
Insulator	Thermoplastic/As Molded

Conforms to

UL 514B
CSA C22.2 No. 18
NEMA FB1

Listed/Certified by

UL (UL File No. 23018)
CSA (LR-2884, LR-4484)

RANGE	HUB SIZE	CONDUIT SIZE	CABLE OPENING
3110 Series Straight Connectors	1/4" thru 5" NPS	3/8" thru 5"	.437" to 5.500"
3130 Series 90° Connectors	1/4" thru 4" NPS	3/8" thru 4"	.437" to 4.560"

(All hubs provided with straight pipe threads NPS)

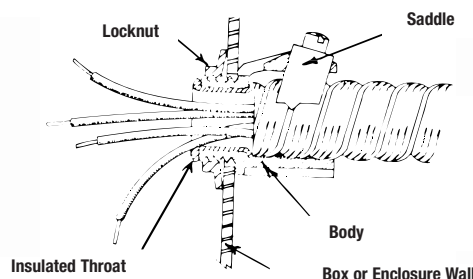

Typical Installation

T&B Fittings

United States
Tel: 901.252.8000
800.816.7809
Fax: 901.252.1354

Canada
Tel: 450.347.5318
Fax: 450.347.1976

Technical Services
Tel: 888.862.3289

Thomas & Betts

www.tnb.com

Metal Clad Cable, Armored Cable and Flexible Metal Conduit Fittings

Designed to resist vibration and strain!

TITE-BITE® Connectors — Nylon-Insulated



T&B Fittings



CAT. NO.	CABLE OPENING		TRADE SIZE	K.O. SIZE	DIMENSIONS (IN.)		
	MAX.	MIN.			A†	B	C
3110-TB**#	.660	.470	3/8"	1/2"	1 1/4"	1 1/8"	g
3112#	.937	.750	1/2"	1/2"	1 1/4"	1 1/8"	g
3115#	1.125	.906	3/4"	3/4"	1 5/8"	1 3/4"	1 1/32"
3117#	1.468	1.250	1"	1"	2 1/8"	1 3/4"	1 1/8"
3118***	1.750	1.562	1 1/4"	1 1/4"	2 3/4"	2	1 1/4"
3119***	2.031	1.812	1 1/2"	1 1/2"	3 1/8"	2 5/8"	1 3/4"
3120***	2.500	2.312	2"	2"	3 3/4"	2 3/4"	1 5/16"
3121***	3.062	2.812	2 1/2"	2 1/2"	4 3/8"	3 3/4"	2 1/4"
3122***	3.562	3.312	3"	3"	5	3 3/4"	2 1/4"
3123***††	4.060	3.620	3 1/2"	3 1/2"	—	—	—
3124***	4.560	4.120	4"	4"	—	—	—

**UL Listed for armored cable only.

***UL Listed for flexible metal conduit only.

Material: Steel thru 3/4" trade size.

†Approximate dimension with screw at minimum height.

UL File No. E 23018

CSA File No. 2884

††CSA not applicable.

Approved for Metal Clad Cable

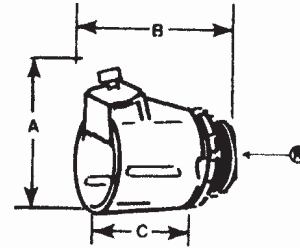

- Steel or malleable iron construction
- Tough, insulated lining and Tite-Bite® design make these connectors a "must" when conductors are subject to vibration or strain
- Look for the unique T&B blue color to ensure the highest quality fitting

Completely salvageable!

TITE-BITE® Connectors



CAT. NO.	CABLE OPENING		TRADE SIZE	K.O. SIZE	DIMENSIONS (IN.)		
	MAX.	MIN.			A†	B	C
300-TB**#	.660	.470	3/8"	1/2"	1 1/4"	1 1/16"	3/16"
302-TB#	.937	.750	1/2"	1/2"	1 1/8"	1 1/16"	1/4"
304#	1.093	.906	3/4"	3/4"	1 1/8"	1 1/16"	1 1/32"
306#	1.468	1.250	1"	1"	2 1/8"	1 3/4"	1 1/4"
308***	1.750	1.562	1 1/4"	1 1/4"	2 5/8"	2 1/32"	1 1/4"
310***	2.031	1.812	1 1/2"	1 1/2"	2 3/8"	2 1/16"	1 3/4"
312***	2.500	2.312	2"	2"	3 1/8"	2 1/16"	1 5/16"
314***	3.062	2.812	2 1/2"	2 1/2"	3 3/8"	3 1/8"	2 1/4"
316***	3.562	3.312	3"	3"	4 1/8"	3 3/16"	2 1/4"

**UL Listed for armored cable only.

***UL Listed for flexible metal conduit only.

†Approximate dimension with screw at minimum height.

UL File No. E 23018

CSA File No. 2884

Material: Steel thru 1/2" trade size.

Approved for Metal Clad Cable

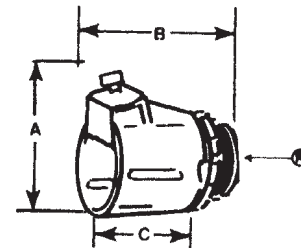

- Easy to install with double-grip saddle
- 3/8" and 1/2" sizes made of formed steel, which produces uniform high quality and a smooth throat to protect conductor insulation
- 3/4" and larger size are malleable iron

Metal Clad Cable, Armored Cable and Flexible Metal Conduit Fittings

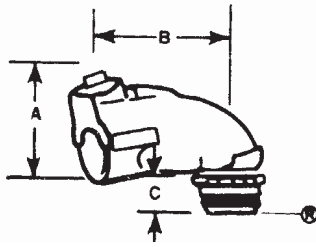

- Steel or malleable iron construction
- Offers all of the advantages of the straight connector with only one screw to tighten, except in the larger sizes, which have two
- Peep hole on top provides for easy inspection of ABC bushing
- Narrow design makes it easy to install connectors in adjacent knockouts

The easiest and best connector to install when making sharp bends at the enclosure or equipment!

TITE-BITE® Connectors — 90° Angle Nylon-Insulated



CAT. NO.	CABLE OPENING		TRADE SIZE	K.O. SIZE	DIMENSIONS (IN.)		
	MAX.	MIN.			A†	B	C
3130-TB#	.660	.470	3/8"	1/2"	1 11/32	1 19/32	19/16
3132#	.937	.750	1/2"	1/2"	1 1/8	2 1/16	1 9/16
3135#	1.093	.906	3/4"	3/4"	2 1/8	2 7/8	9/8
3137#	1.468	1.250	1"	1"	2 21/32	2 7/8	1 1/2
3138***	1.750	1.562	1 1/4"	1 1/4"	3 3/16	3 3/32	9/8
3139***	2.031	1.812	1 1/2"	1 1/2"	4	4 3/8	1 1/16
3140***	2.500	2.312	2"	2"	4 15/16	5 1/16	1 1/16
3141***	3.062	2.812	2 1/2"	2 1/2"	6 5/32	6	3/4
3142***	3.562	3.312	3"	3"	7 11/32	7 1/16	3/4
3143†††	4.060	3.620	3 1/2"	3 1/2"	—	—	—
3144-TB***	4.560	4.120	4"	4"	—	—	—

***UL Listed for flexible metal conduit only.

CSA File No. 2884

†Approximate dimension with screw at minimum height.

TITE-BITE® Connectors* — 90° angle

†††Not UL Listed or CSA Certified.

Approved for Metal Clad Cable

UL File No. E 23018

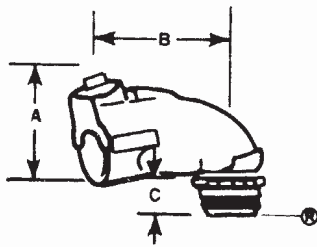

- Throat is long enough to install in cast housing knockouts
- 3/8" and 1/2" sizes of steel construction
- 3/4" and larger sizes made of malleable iron

Angle clip provides secure mechanical grip that tightens under tension or vibration!

TITE-BITE® Connectors — 90° Angle



CAT. NO.	CABLE OPENING		TRADE SIZE	K.O. SIZE	DIMENSIONS (IN.)		
	MAX.	MIN.			A†	B	C
321-TB#	.660	.470	3/8"	1/2"	1 11/32	1 1/2	3/8
323#	.937	.750	1/2"	1/2"	1 1/8	2 3/8	1 1/32
325#	1.093	.906	1/2"	1/2"	2 1/8	2 7/8	7/8
326-TB#	1.468	1.250	1"	1"	2 21/32	2 7/8	1
327-TB***	1.750	1.562	1 1/4"	1 1/4"	3 3/8	3 3/8	—
328***	2.031	1.812	1 1/2"	1 1/2"	4 1/8	4 1/8	—
329***	2.500	2.312	2"	2"	4 3/8	4 31/32	—
330-TB***	3.062	2.812	2 1/2"	2 1/2"	6 1/2	6	—
331***	3.562	3.312	3"	3"	5 25/32	7	—

***UL Listed for flexible metal conduit only.

CSA File No. 2884

†Approximate dimension with screw at minimum height.

Approved for Metal Clad Cable

UL File No. E 23018



- Can be used on smooth or corrugated aluminum sheathed and steel MC cable
- One-screw design enables quick installation

Unique saddle design firmly secures cable in place, provides holding power in excess of listing agency requirements and ensures high-quality bonding!

TITE-BITE® Aluminum Sheathed Cable Connectors



CAT. NO.	DIA. RANGE ALUM. SHEATH (IN.)	HUB SIZE
2492	(.370-.500)	1/2"

UL Listed as a grounding means for steel MC cable and ALS. For dry location.

CSA File No. 589

UL File No. E 38947

Tite-Bite® Connectors are approved for continuous sheathed corrugated MC cable.

United States
Tel: 901.252.8000
800.816.7809
Fax: 901.252.1354

Canada
Tel: 450.347.5318
Fax: 450.347.1976

Technical Services
Tel: 888.862.3289

Thomas & Betts

www.tnb.com

Metal Clad Cable, Armored Cable and Flexible Metal Conduit Fittings

Fits every size of armored cable, leaded cable and flexible conduit!



Squeeze Connectors

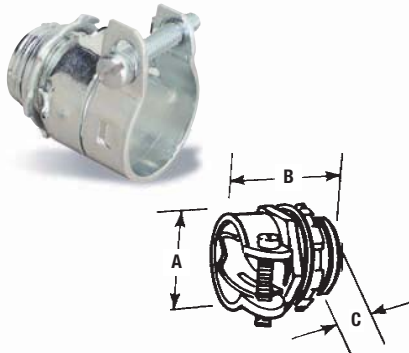

CAT. NO.	CABLE OPENING		TRADE SIZE	K.O. SIZE	DIMENSIONS (IN.)		
	MAX.	MIN.			A†	B	C
252***	.531	.437	5/16"	3/8"	13/16	25/32	11/32
253TB**	.585	.455	3/8"	1/2"	3/2	113/64	3/8
254-TB	.938	.812	1/2"	1/2"	13/2	13/8	13/32
255	1.094	.938	3/4"	3/4"	13/4	117/32	7/16
256	1.375	1.250	1"	1"	119/32	13/8	1/2
257***	1.656	1.500	11/4"	11/4"	13/8	123/32	17/32
258***	1.875	1.688	11/2"	11/2"	23/4	13/8	9/16
259***	2.500	2.313	2"	2"	231/32	23/8	11/16
249***	3.062	2.812	21/2"	21/2"	33/16	217/16	3/4
277***	3.563	3.312	3"	3"	313/16	23/8	3/4
278-TB	4.370	3.200	31/2"	31/2"	63/8	53/4	117/16
281-TB	4.600	3.500	4"	4"	73/4	53/4	13/8

- Malleable iron or steel construction
- Catalog No. 253 is steel

** UL Listed for armored cable only. Fitting material steel. UL File No. E 23018
 *** UL Listed for flexible metal conduit only. CSA File No. 2884
 † Approximate dimension with screw at minimum height.

Only two screws to tighten!

Squeeze Connectors — 90° Angle

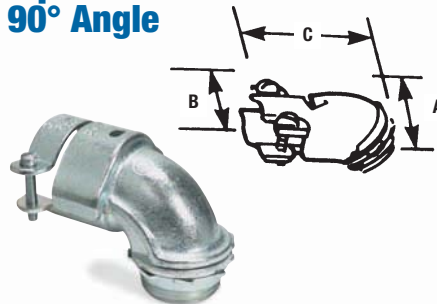

CAT. NO.	CABLE OPENING		TRADE SIZE	K.O. SIZE	DIMENSIONS (IN.)		
	MAX.	MIN.			A	B	C
266-TB	.656	.406	3/8"	1/2"	11/2	113/32	17/16
272**	.812	.688	3/8"	1/2"	13/8	13/8	—
268-TB	.937	.813	1/2"	1/2"	117/16	113/16	13/8
279	1.000	.875	3/4"	3/4"	113/16	21/16	13/16
270	1.125	1.000	3/4"	3/4"	13/8	13/4	113/16
273TB	1.406	1.187	1"	1"	23/8	21/2	21/16
274***	1.656	1.375	11/4"	11/4"	3	3	3
275***	1.875	1.625	11/2"	11/2"	33/8	33/16	4
276***	2.500	2.125	2"	2"	43/8	313/16	43/8
282-TB	3.100	2.520	21/2"	21/2"	43/16	517/16	73/16
283-TB	3.640	3.100	3"	3"	53/16	63/16	83/16
284-TB	4.220	3.700	31/2"	31/2"	637/16	83/16	111/4
285-TB	4.600	4.100	4"	4"	73/4	83/8	123/8

- Cap lifts off simply by loosening screws partway
- 3/8" and 1/2" sizes made of steel
- 3/4" and larger sizes made of malleable iron

** UL Listed for armored cable only. UL File No. E23018
 *** UL Listed for flexible metal conduit only. CSA File No. 2884

Fast and easy installation — simply loosen screws partway to lift off cap!

Squeeze Connectors — 45° Angle

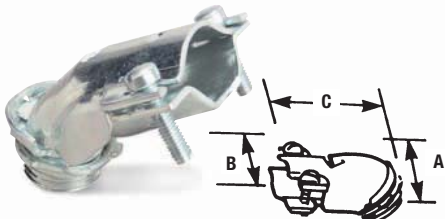

CAT. NO.	CABLE OPENING		TRADE SIZE	K.O. SIZE	DIMENSIONS (IN.)		
	MAX.	MIN.			A	B	C
265	.656	.406	3/8"	1/2"	117/32	15/32	11/8
267	.937	.813	1/2"	1/2"	123/32	1/2	11/4
269	1.125	1.000	3/4"	3/4"	2	17/32	13/16

- 3/8" and 1/2" sizes made of steel
- 3/4" and larger sizes made of malleable iron

UL File No. E-23018
 CSA File No. 2884

Metal Clad Cable, Armored Cable and Flexible Metal Conduit Fittings



Armor-gripping saddle stays open by itself when cable is being inserted!

Two-Screw Connectors

- Formed steel body
- Carefully round bushing

CAT. NO.	CABLE OPENING		TRADE SIZE	K.O. SIZE	DIMENSIONS (IN.)		
	MAX.	MIN.			A	B	C
3301-TB**	.656	.250	3/8"	1/2"	3/2"	1 1/16"	1 1/16"
3312-TB	.937	.500	1/2"	1/2"	1 1/2"	1"	1"

** UL Listed for armored cable only. UL File No. E 1383 CSA File No. 2884

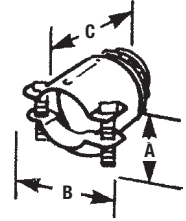

For non-metallic and armored cable

Duplex Clamp Connector

- Malleable iron construction

CAT. NO.	K.O. SIZE	DIMENSIONS (IN.)	
		A	B
291-TB	1/2"	1 1/2"	1 1/16"

UL File No. E 1383 CSA File No. 2884

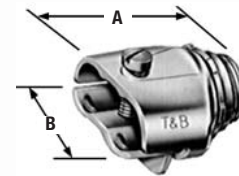

TITE-BITE® design holds flexible metal cable firmly in place with a single screw!

Adapter — EMT to Flex

CAT. NO.	SIZE FLEX TO EMT	DIMENSIONS (IN.)		
		A	B	C
503TB	1/2" - 1/2"	1 1/2"	1 1/16"	1"
504	3/4" - 3/4"	1 5/8"	1 1/16"	2"
505-TB	1" - 1"	2 1/2"	2 1/16"	2 1/2"

CSA File No. 8994 UL File No. E-23018

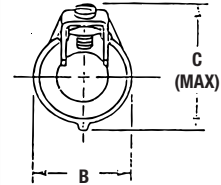
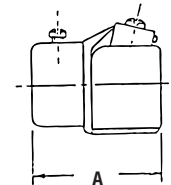

One-piece fitting couples 3/8" flexible metal conduit to 1/2" EMT!

Combination Coupling

CAT. NO.	SIZE FLEX TO EMT	DIMENSIONS (IN.)		
		A	B	C
449-TB	3/8" - 1/2"	1 1/2"	1 1/2"	1 5/16"

Cable opening: max. .656, min. .250 UL File No. E-23018 CSA File No. 2884

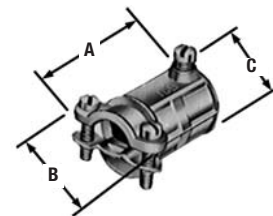

Smooth plastic bushing protects conductor insulation from rough edges of armored cable and flexible metal conduit!

Anti-Short Bushing

CAT. NO.	SIZE
390	14-2, 14-3, 12-2
391	14-4, 12-3, 6-1, and 4-1
392	12-4, 10-2, 10-3 and 2-1
393	10-4, 8-2, 8-3, and 1-1
394	8-4, 6-2, 6-3, 4-2, 4-3, and 6-4

Colorized Temperature Rating: 240° F

CSA File No. 589
UL not applicable.



Fast and easy installation!

Strap

- Elongated bolt hole makes alignment easy, even when holes in mounting surface are off center
- Snap-on design holds strap in place



CAT. NO.	SIZE
65-TB	3/8" Flex

