

Humidity Sensor Units

CHS Series CHS-U, -SS, -C Types

TDK's CHS series humidity sensors are compact and extremely simple to apply. Because they contain the necessary circuitry, there is no need to provide additional control circuitry or perform time-consuming calibration. With simple connection to a power supply, they will output DC at 100% relative humidity. This makes it possible to read RH directly with a voltmeter.

CHS-U TYPE

For industrial use and measuring equipment

FEATURES

- These sensors can measure a wide range of humidity – from 5(%) to 95(%)RH.
- They are highly accurate. The nominal accuracy for the CHS-UPR and CHR-UPS is within ± 3 (%) RH.

Type	CHS-UGS CHS-UGR	CHS-UPS CHS-UPR
Nominal accuracy(%)RH	± 5	± 3
Measuring range(%)RH	5 to 95	5 to 95

- Characteristics are stable over a wide temperature range.
- Humidity sensing characteristics exhibit virtually no hysteresis.
- Highly cost-effective and compact, requiring extremely little mounting space.
- Low current consumption.
- Outputs DC.1V at 100(%)RH; relative humidity can be read directly with a voltmeter.
- All-in-one construction integrates sensor with support circuitry. The entire module operates off a 5V power supply.
- Generated ripple at low humidity levels will not exceed 2.5mV.

SHAPES AND DIMENSIONS

SQUARE TYPE

CHS-UGS, -UPS

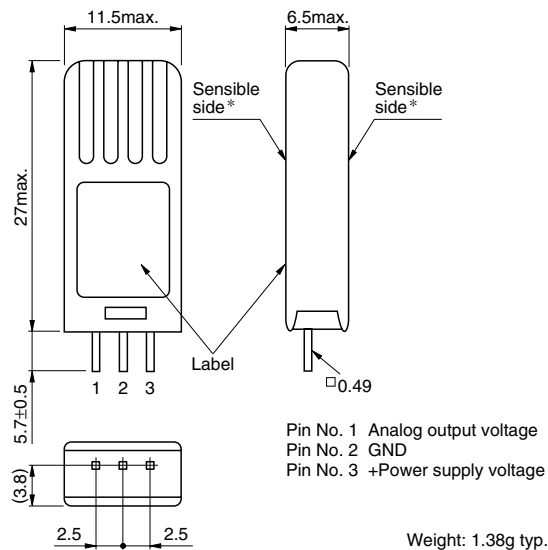

MAXIMUM RATINGS (Ta=25°C)

Power supply voltage Edc	7V max.
Operating conditions	0 to +50°C, power supply voltage 5V, without dewing
Storage conditions	-20 to +60°C, without dewing

ROUND TYPE

CHS-UGR, -UPR

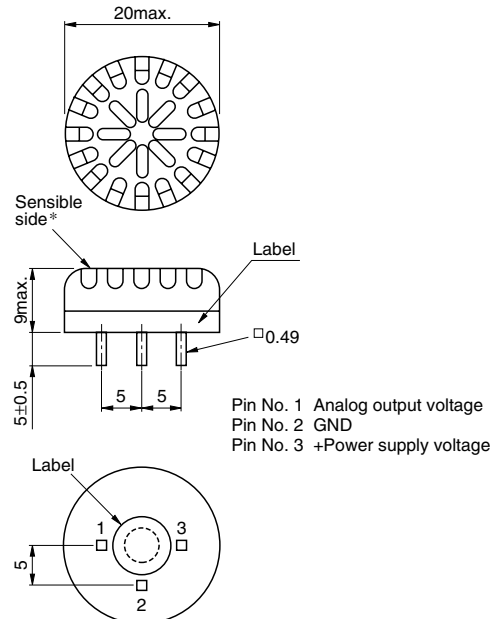

*When installing the device, ensure that the humidity sensing surface is not obstructed.

Weight: 1.68g typ.
Dimensions in mm
Tolerance: ± 0.2

CHS-U TYPE

ELECTRICAL CHARACTERISTICS

Item	Specifications			Conditions
	Minimum	Standard	Maximum	
Operating voltage E_{dc} (V)	4.75	5	5.25	
Operating current (mA)			0.6	$E_{dc}=5V, 25^{\circ}C$
Output voltage (mV)/(%)RH		10		$E_{dc}=5V, 25^{\circ}C, 5$ to 95(%RH)
Output impedance (k Ω)		(200)*		at DC
Accuracy (%RH)	CHS-UPS, -UPR	-3	+3	$E_{dc}=5V, 25^{\circ}C, 5$ to 95(%RH) (For details, please refer to typical characteristics)
	CHS-UGS, -UGR	-5	+5	
Hysteresis (%RH)		= 0		Stable time: 20min
Temperature dependency (%RH)	-5		+5	$E_{dc}=5V, 25^{\circ}C$ standard, +5 to +45 $^{\circ}C, 5$ to 95(%RH)
Response time (min)		1		Response time to reach 90% of actual humidity as for from 30 to 85(%RH)
Recommended operating temperature ($^{\circ}C$)	+5		+45	$E_{dc}=5V$

*(): Reference value

TYPICAL CHARACTERISTICS

SENSOR LINEARITY CHARACTERISTICS ($T_a=25^{\circ}C$ $E_{dc}=5V$)

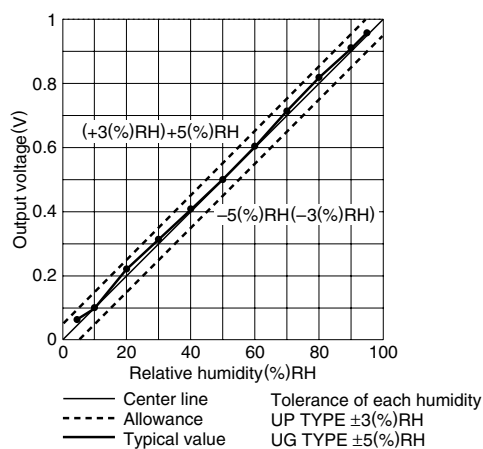

TEMPERATURE DEPENDENCY CHARACTERISTICS

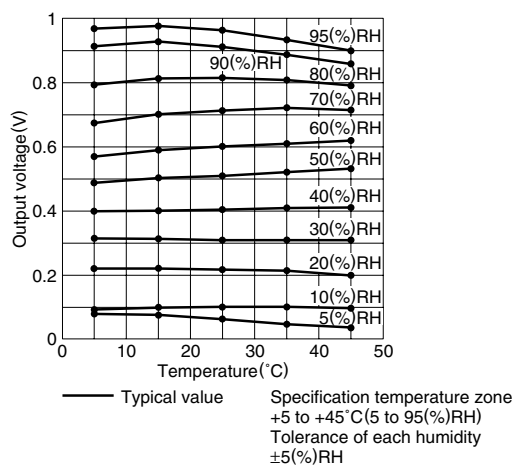

CHS-SS TYPE

For consumer and office equipment

FEATURES

- Humidity sensing characteristics exhibit virtually no hysteresis.
- Compact size.
- Low current consumption.
- Outputs DC.1V at 100(%)RH; relative humidity can be read directly with a voltmeter.
- All-in-one construction integrates sensor with support circuitry. The entire module operates off a 5V power supply.
- Generated ripple at low humidity levels will not exceed 2.5mV.

Type	CHS-GSS	CHS-MSS
Nominal accuracy(%)RH	±5	±5
Measuring range(%)RH	5 to 90	20 to 85

MAXIMUM RATINGS (Ta=25°C)

Power supply voltage Edc	7V max.
Operating conditions	0 to +50°C, power supply voltage 5V, without dewing
Storage conditions	-20 to +60°C, without dewing

SHAPES AND DIMENSIONS

SQUARE TYPE

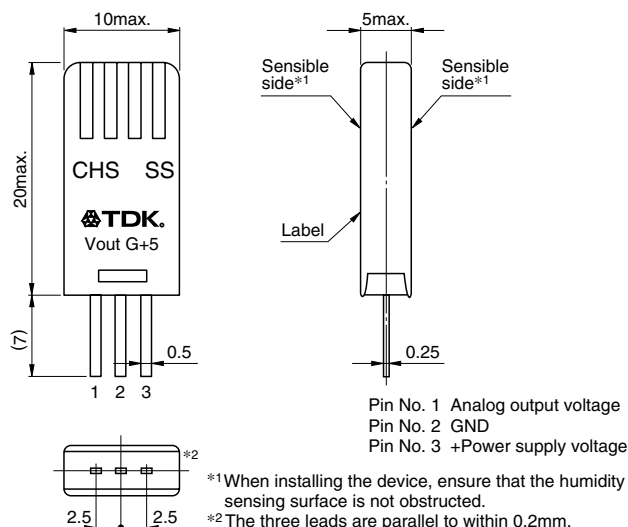

Weight: 1.1g typ.

Dimensions in mm
Tolerance: ±0.2

ELECTRICAL CHARACTERISTICS

Item	Specifications			Conditions
	Minimum	Standard	Maximum	
Operating voltage Edc (V)	4.75	5	5.25	
Operating current(mA)			0.6	E _{dc} =5V, 25°C
Output voltage(mV)/(%)RH		10		E _{dc} =5V, 25°C
Output impedance(kΩ)		(200)*		at DC
Accuracy(%)RH	CHS-GSS	-5	+5	E _{dc} =5V, 25°C, 5 to 90(%)RH(For details, please refer to typical characteristics)
	CHS-MSS	-5	+5	E _{dc} =5V, 25°C, 20 to 85(%)RH(For details, please refer to typical characteristics)
Hysteresis(%)RH		= 0		Stable time: 20min
Temperature dependency(%)RH	-5		+5	E _{dc} =5V, 25°C standard
Response time(min)		1		Response time to reach 90% of actual humidity as for from 30 to 85(%)RH
Recommended operating temperature(°C)	CHS-GSS	+5	+45	E _{dc} =5V, without dewing
	CHS-MSS	+15	+35	(For details, please refer to typical characteristics)

*(): Reference value

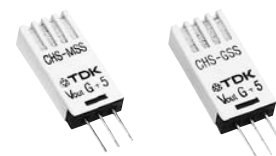

• All specifications are subject to change without notice.

CHS-SS TYPE
TYPICAL CHARACTERISTICS

SENSOR LINEARITY CHARACTERISTICS (Ta=25°C Edc=5V)

CHS-GSS TYPE

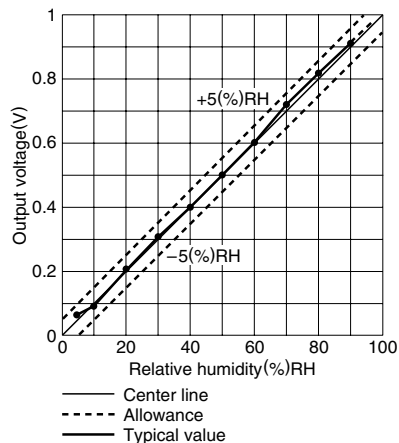

TEMPERATURE DEPENDENCY CHARACTERISTICS

CHS-GSS TYPE

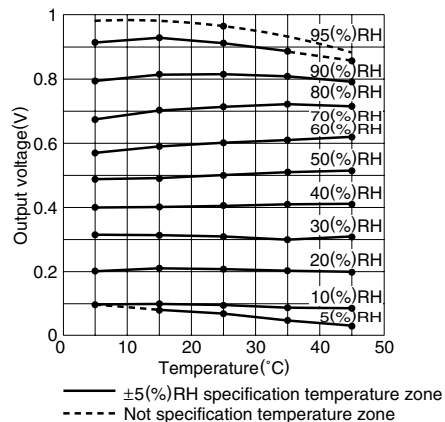

CHS-MSS TYPE

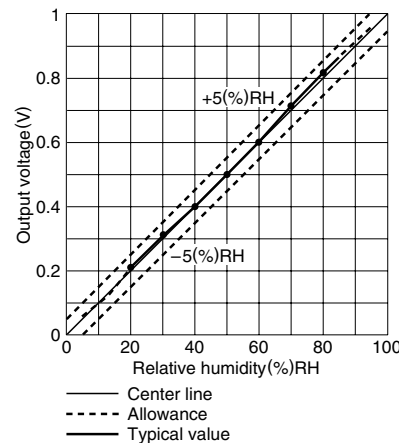

CHS-MSS TYPE

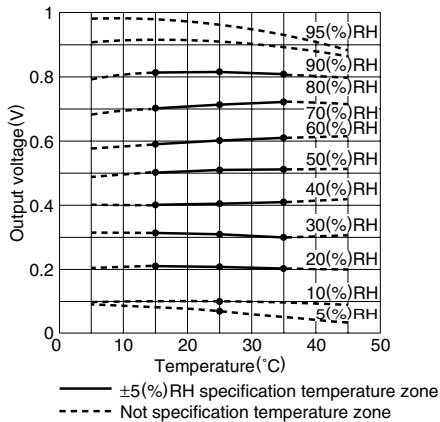

• All specifications are subject to change without notice.

CHS-C TYPE

For consumer and office equipment

FEATURES

- Temperature detection thermistor can be added.
- Humidity sensing characteristics exhibit virtually no hysteresis.
- Low current consumption.
- Absolute humidity can be read directly with DC. 1V voltmeter.
- All-in-one construction incorporates circuits and 5V power supply operation.
- Generated ripple at low humidity levels will not exceed 2.5mV.

Type	CHS-CMC-__
Nominal accuracy(%)RH	±5
Measuring range(%)RH	30, 50, 80

MAXIMUM RATINGS (Ta=25°C)

Power supply voltage Edc	7V max.
Operating conditions	0 to +50°C, power supply voltage 5V, without dewing
Storage conditions	-20 to +60°C, without dewing

SHAPES AND DIMENSIONS

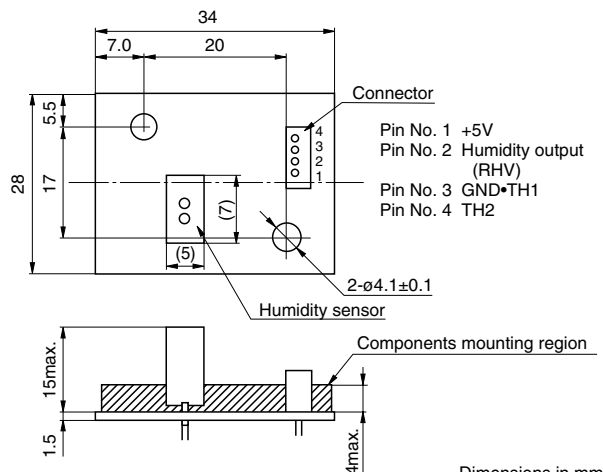

Dimensions in mm
Tolerance: ±0.5

ELECTRICAL CHARACTERISTICS

Item	Specifications			Conditions
	Minimum	Standard	Maximum	
Operating voltage Edc (V)	4.75	5	5.25	
Operating current(mA)			0.6	E _{dc} =5V, 25°C
Output impedance(kΩ)		(200)		at DC
Accuracy(%)RH	30(%)RH	-5 (0.5V)	+5 (0.6V)	E _{dc} =5V, 25°C
	50(%)RH	-5 (0.86V)	+5 (0.96V)	(For details, please refer to typical characteristics)
	80(%)RH	-5 (1.5V)	+5 (1.7V)	
Hysteresis(%)RH		= 0		Stable time: 20 min
Temperature dependency(%)RH	-5		+5	E _{dc} =5V, 25°C standard (For details, please refer to typical characteristics)
Response time(min)		1		Response time to reach 90% of actual humidity as for from 30 to 85(%)RH
Recommended operating temperature(°C)	+15		+35	E _{dc} =5V

RECOMMENDED CHARACTERISTICS OF TEMPERATURE DETECTION THERMISTOR

Part No.	NTCCM16084BH103JC
Resistance value(Between TH1 and TH2)	10kΩ±5%
Constant B	4100K±3%
Maximum rated power	230mW

• All specifications are subject to change without notice.

CHS-C TYPE

TYPICAL CHARACTERISTICS

SENSOR LINEARITY CHARACTERISTICS(Ta=25°C, Edc=5V)

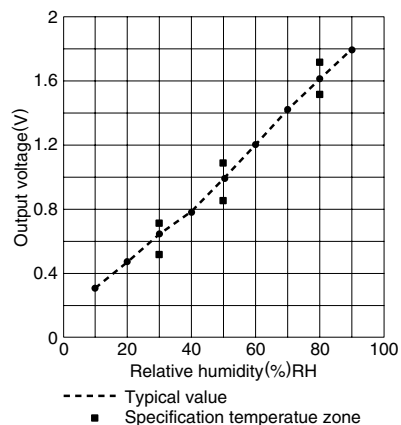

TEMPERATURE DEPENDENCY CHARACTERISTICS

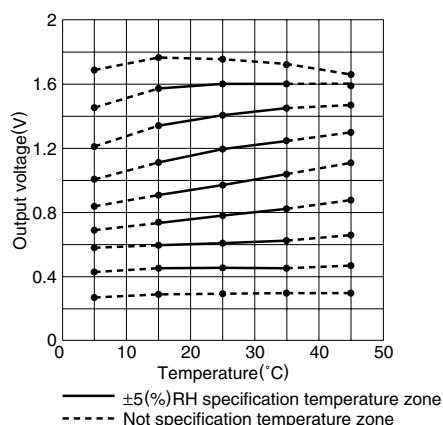

TYPICAL APPLICATIONS

HUMIDITY MONITOR

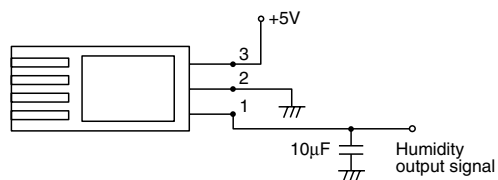

BATTERY POWERED SYSTEM

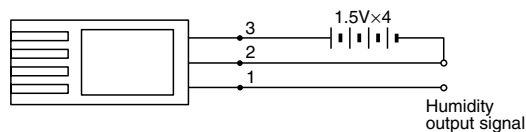

• All specifications are subject to change without notice.