

4.3 Shureseal™

Cable glands Metallic cable glands

- High performance metal cable fittings
- Special construction prevents twisting and ensures effective strain relief
- Easy to install
- For cables with outer diameters from 3.2 mm to 47.6 mm

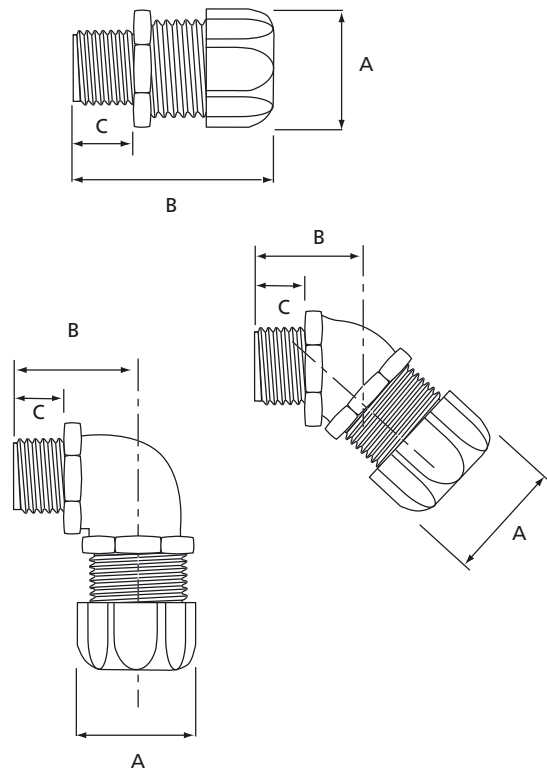

Technical Information

Style/thread	Straight, 45° and 90° NPT and metric (I.S.O.) threads
System IP rating	IP65
Body (material)	Zinc or galvanized steel
Gland nut (material)	Steel or galvanised steel
Seal (material)	Neoprene or rubber
Colour	Metallic
Temperature range	-35°C to +105°C

Approvals



052391
00589
004484



E-13938

Ordering Information

PRODUCT REF.	MATERIAL BODY	MATERIAL SEAL	MATERIAL NUT	CABLE Ø RANGE FROM...TO [mm]	THREAD SIZE	DIMENSIONS			QUANTITY [pieces]
						A [mm]	B [mm]	C [mm]	
STRAIGHT METALLIC CABLE GLAND WITH METRIC (I.S.O.) THREAD									
9520	zinc plated steel	Neoprene	zinc plated steel	3.2 - 6.3	M20	28.6	42.0	14.3	25
9521-EU	zinc plated steel	Neoprene	zinc plated steel	6.3 - 9.5	M20	28.6	42.0	14.3	25
9522-EU	zinc plated steel	Neoprene	zinc plated steel	9.5 - 12.7	M20	28.6	42.0	14.3	25
9523	zinc plated steel	Neoprene	zinc plated steel	11.4 - 14.2	M20	28.6	42.0	14.3	25
9524-EU	zinc plated steel	Neoprene	zinc plated steel	12.7 - 15.8	M20	34.9	44.5	15.0	25
90° METALLIC CABLE GLAND WITH NPT THREAD									
4960	zinc plated steel	rubber	steel	3.2 - 9.5	1/2"	28.6	44.5	15.9	25
4961	zinc plated steel	rubber	steel	7.9 - 14.2	1/2"	28.6	44.5	15.9	25
4970	zinc plated steel	rubber	steel	3.2 - 9.5	3/4"	34.9	45.2	17.5	10
4971	zinc plated steel	rubber	steel	7.9 - 14.2	3/4"	34.9	45.2	17.5	10
4972	zinc plated steel	rubber	steel	12.7 - 19.0	3/4"	34.9	45.2	17.5	10

Ordering Information

PRODUCT REF.	MATERIAL BODY	MATERIAL SEAL	MATERIAL NUT	CABLE Ø RANGE FROM...TO [mm]	THREAD SIZE [inch]	DIMENSIONS			QUANTITY [pieces]
						A [mm]	B [mm]	C [mm]	
STRAIGHT METALLIC CABLE GLAND WITH NPT THREAD									
2920	zinc	rubber	zinc plated steel	3.2 - 9.5	1/2	28.6	44.5	15.9	25
2921	zinc	rubber	zinc plated steel	7.9 - 14.2	1/2	28.6	44.5	15.9	25
2922	zinc	rubber	zinc plated steel	12.7 - 19.1	1/2	34.9	44.5	15.9	10
2930	zinc	rubber	zinc plated steel	3.2 - 9.5	3/4	34.9	45.2	19.1	10
2931	zinc	rubber	zinc plated steel	7.9 - 14.2	3/4	34.9	45.2	19.1	10
2932	zinc	rubber	zinc plated steel	12.7 - 19.1	3/4	34.9	45.2	19.1	10
2940	zinc	rubber	zinc plated steel	7.9 - 14.2	1	34.9	44.5	20.6	10
2941	zinc	rubber	zinc plated steel	12.7 - 19.1	1	34.9	44.5	20.6	10
2942	zinc	rubber	zinc plated steel	17.8 - 24.1	1	41.3	47.6	20.6	10
2520	zinc	Neoprene	steel	3.2 - 6.4	1/2	29.4	42.9	15.9	25
2521	zinc	Neoprene	steel	6.4 - 9.5	1/2	29.4	42.9	15.9	25
2522	zinc	Neoprene	steel	9.5 - 12.7	1/2	29.4	42.9	15.9	25
2523	zinc	Neoprene	steel	11.4 - 14.2	1/2	29.4	42.9	15.9	25
2524	zinc	Neoprene	steel	12.7 - 15.9	1/2	34.9	44.5	15.9	25
2525	zinc	Neoprene	steel	15.9 - 19.1	1/2	34.9	44.5	15.9	25
2558	zinc	Neoprene	steel	22.4 - 27.1	1 1/4	53.2	54.8	20.6	5
2559	zinc	Neoprene	steel	27.1 - 30.6	1 1/4	53.2	54.8	20.6	5
2562	zinc	Neoprene	steel	20.6 - 25.4	1 1/2	58.7	63.5	17.5	5
2563	zinc	Neoprene	steel	25.4 - 30.1	1 1/2	58.7	63.5	17.5	5
2574	zinc	Neoprene	steel	34.9 - 41.3	2	69.9	66.7	20.6	1
2575	zinc	Neoprene	steel	41.3 - 47.6	2	69.9	66.7	20.6	1
45° METALLIC CABLE GLAND WITH NPT THREAD									
2200	zinc plated malleable iron	Neoprene	zinc plated steel	3.2 - 6.3	1/2	28.6	7.1	14.3	25
2201	zinc plated malleable iron	Neoprene	zinc plated steel	6.3 - 9.5	1/2	28.6	7.1	14.3	25
2202	zinc plated malleable iron	Neoprene	zinc plated steel	9.5 - 12.7	1/2	28.6	7.1	14.3	25
2203	zinc plated malleable iron	Neoprene	zinc plated steel	11.4 - 14.2	1/2	28.6	7.1	14.3	25
2204	zinc plated malleable iron	Neoprene	zinc plated steel	12.7 - 15.9	1/2	34.9	10.3	14.3	10
2205	zinc plated malleable iron	Neoprene	zinc plated steel	15.9 - 19.1	1/2	34.9	35.7	14.3	10
2206-TB	zinc plated malleable iron	Neoprene	zinc plated steel	3.2 - 6.3	3/4	34.9	35.7	15.9	10
2207-TB	zinc plated malleable iron	Neoprene	zinc plated steel	6.3 - 9.5	3/4	34.9	35.7	15.9	10
2208-TB	zinc plated malleable iron	Neoprene	zinc plated steel	9.5 - 12.7	3/4	34.9	35.7	15.9	10
2209	zinc plated malleable iron	Neoprene	zinc plated steel	12.7 - 15.9	3/4	34.9	35.7	15.9	10
2210	zinc plated malleable iron	Neoprene	zinc plated steel	15.9 - 19.1	3/4	34.9	35.7	15.9	10
2211	zinc plated malleable iron	Neoprene	zinc plated steel	19.1 - 22.2	3/4	42.9	38.1	38.1	10
2213	zinc plated malleable iron	Neoprene	zinc plated steel	9.5 - 12.7	1	34.9	38.1	19.8	5
2214	zinc plated malleable iron	Neoprene	zinc plated steel	12.7 - 15.9	1	34.9	38.1	19.8	5
2215	zinc plated malleable iron	Neoprene	zinc plated steel	15.9 - 19.1	1	34.9	38.1	19.8	5
2216	zinc plated malleable iron	Neoprene	zinc plated steel	19.1 - 22.2	1	42.9	37.3	19.8	5
2217	zinc plated malleable iron	Neoprene	zinc plated steel	22.2 - 25.0	1	42.9	37.3	19.8	5
2218	zinc plated malleable iron	Neoprene	zinc plated steel	22.3 - 27.0	1	52.4	50.0	19.8	5
2219	zinc plated malleable iron	Neoprene	zinc plated steel	27.0 - 30.1	1	52.4	50.0	19.8	5
2220-TB	zinc plated malleable iron	Neoprene	zinc plated steel	22.3 - 27.0	1 1/4	52.4	48.4	20.6	2
2221	zinc plated malleable iron	Neoprene	zinc plated steel	27.0 - 30.1	1 1/4	52.4	48.4	20.6	2
2222	zinc plated malleable iron	Neoprene	zinc plated steel	30.1 - 34.9	1 1/4	52.4	57.2	20.6	2
2223	zinc plated malleable iron	Neoprene	zinc plated steel	34.9 - 37.7	1 1/4	52.4	57.2	20.6	2

4.3 Shureseal™

Cable glands Plastic cable glands

- High performance plastic cable fittings
- Special construction prevents twisting and ensures effective strain relief
- Easy to install
- For all cable sizes between 3.2 and 24.1 mm of outer diameter

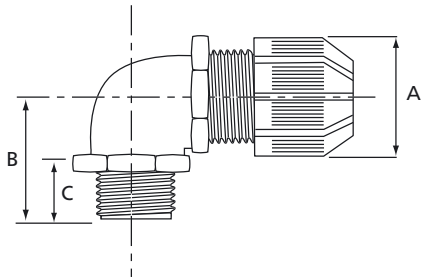
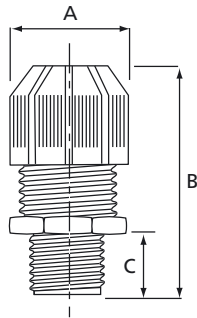

Technical Information

Style/thread	Straight and 90° NPT threads
IP rating	IP65
Material	UV resistant polyamide 6.6.
Steel locknut	Chromate finished steel or zinc
Seal	Neoprene
Colour	Black
Flammability rating	UL 94 V-2
Temperature range	-34°C to +105°C

Approvals



052391



E-13938

Ordering Information

PRODUCT REF.	CABLE DIAMETER RANGE FROM...TO [mm]	THREAD SIZE [inch]	DIMENSIONS			QUANTITY [pieces]
			A [mm]	B [mm]	C [mm]	
STRAIGHT PLASTIC CABLE GLAND WITH NPT THREAD						
2920NM	3.2 - 9.5	1/2	26.2	54.0	15.9	25
2921NM	7.9 - 14.2	1/2	26.2	54.0	15.9	25
2922NM	12.7 - 19.0	1/2	35.7	54.0	15.9	25
2930NM	3.2 - 9.5	3/4	35.7	55.6	15.9	10
2931NM	7.9 - 14.2	3/4	35.7	55.6	15.9	10
2932NM	12.7 - 14.2	3/4	35.7	55.6	15.9	10
2940NM	7.9 - 14.2	1	35.7	59.5	19.8	10
2941NM	12.7 - 19.0	1	35.7	59.5	19.8	10
2942NM	17.8 - 24.1	1	42.5	60.3	19.8	10
90° PLASTIC CABLE GLAND WITH NPT THREAD						
4960NM	3.2 - 9.5	1/2	30.9	31.8	15.9	25
4961NM	7.9 - 14.2	1/2	30.9	31.8	15.9	25
4970NM	3.2 - 9.5	3/4	35.7	34.9	15.9	10
4971NM	7.9 - 14.2	3/4	35.7	34.9	15.9	10
4972NM	12.7 - 19.0	3/4	35.7	34.9	15.9	10

Shureseal™

Cable grommets with strain relief

- Supplied with one Ty-Rap® cable tie to ensure a stable, tight and sealed strain relief
- Material with high elasticity
- Can also be used for single cables
- Chemically resistant
- Weather and UV resistant
- Simple and quick installation
- 5 sizes for cable diameters from 4 mm to 32 mm
- Maximal wall thickness 2.2 mm
- Typical applications: In control cabinets, in the building of motor vehicles, in the construction of machines,...



4.3

Technical Information

Material, gland	Neoprene
Material, cable tie	Polyamide 6.6
Colour	Black
Temperature range	-30°C to +90°C
Flammability	UL 514

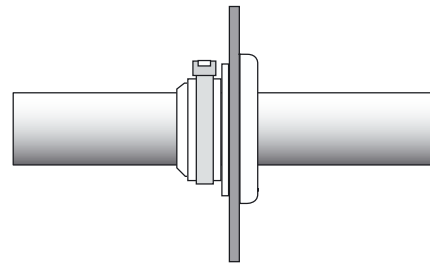
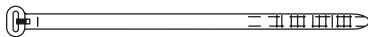
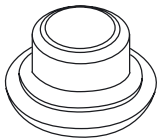
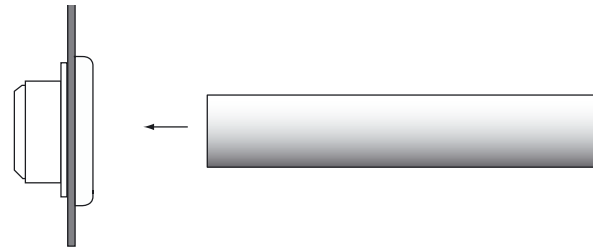
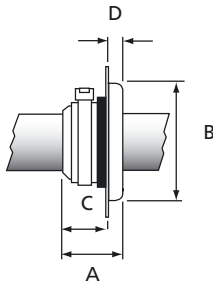

Ordering Information

PRODUCT REF.	MATERIAL	DIMENSIONS				CABLE Ø RANGE FROM ... TO [mm]	FIXING HOLE DIAMETER [mm]	WALL THICKNESS UP TO [mm]	CABLE TIE REFERENCE	WEIGHT [g/100]	QUANTITY [pieces]
		A [mm]	B [mm]	C [mm]	D [mm]						
7401	Neoprene	18.6	24	13.6	5.0	4.0 - 9.0	16	2.2	TY 24 MX	420	10
7402	Neoprene	18.7	28	13.7	5.0	7.0 - 12.0	19	2.2	TY 25 MX	690	10
7403	Neoprene	22.0	34	17.0	5.0	12.0 - 18.0	25	2.2	TY 25 MX	1100	10
7404	Neoprene	24.0	43	19.0	5.0	18.0 - 25.0	32	2.2	TY 25 MX	1500	5
7405	Neoprene	24.5	51	18.5	6.0	25.0 - 32.0	38	2.2	TY 25 MX	1950	5