

Solve Your Basic Sensing Challenges Easily with the E3X-NA Series

- Streamlined features provide basic sensing immediately after plug-in
- *Wire-saving* amplifiers reduce installation time and minimize space requirements
- Master/slave connector design affords connectivity for up to 16 wire-saving amplifiers
- Use the LED bar display to quickly confirm sensor performance
- Optical communication design prevents mutual interference for up to 5 amplifiers
- Green LED models address *mark-detecting* applications
- High-speed models have a response time of 50 μ s
- Select a *water-resistant* model (IP66 rating) using an M8 connector
- Prewired water-resistant models are available





Ordering Information: Amplifier Units, Connectors, Accessories and Fiber-Optics

■ Amplifier Units with Cables

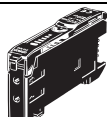

Type	Part number		Control output	Appearance
	NPN output	PNP output		
Standard	E3X-NA11	E3X-NA41	ON/OFF	
High-speed	E3X-NA11F	E3X-NA41F		
Mark-detection	E3X-NAG11	E3X-NAG41		
Water-resistant	E3X-NA11V	E3X-NA41V		

■ Connector-Ready Amplifiers (Order Connector Separately)

Item	Part number		Applicable connector (order separately)		Control output	Appearance
	NPN output	PNP output				
Wire-saving	E3X-NA6	E3X-NA8	Master	E3X-CN11	ON/OFF output	
			Slave	E3X-CN12		
Water-resistant (M8 connectors)	E3X-NA14V	E3X-NA44V	XS3F-M421-40□-A XS3F-M422-40□-A			

■ Amplifier Unit Connectors (Order Separately)

Note: Stickers for Connectors are included as accessories.

Item	Appearance	Cable length	No. of conductors	Part number
Master Connector		2 m	3	E3X-CN11
Slave Connector			1	E3X-CN12

■ Combining Amplifier Units and Connectors (Each Sold Separately)



Refer to the following tables when placing an order. Amplifier Units and Connectors are sold separately.

Amplifier Units			+	Applicable Connectors (Order Separately)	
Type	NPN	PNP		Master Connector	Slave Connector
Wire-saving models	E3X-NA6	E3X-NA8		E3X-CN11 (3-wire)	E3X-CN12 (1-wire)

Example: When Using 5 Amplifier Units



Amplifier Units (5 Units)	+	1 Master Connector + 4 Slave Connectors
---------------------------	---	---

■ Sensor I/O Connectors (Order Separately)

Size	Cable specifications	Appearance	Cable type		Part number
M8	Standard cable	Straight connector 	2 m	Four-core cable	XS3F-M421-402-A
			5 m		XS3F-M421-405-A
		L-shaped connector 	2 m		XS3F-M422-402-A
			5 m		XS3F-M422-405-A

■ Accessories (Order Separately)

Mounting Brackets

Appearance	Applicable models	Quantity	Part number
	E3X-NA□ E3X-NA□F E3X-NAG□	1	E39-L143
	E3X-NA□V		E39-L148

End Plate

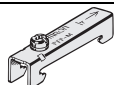
Appearance	Quantity	Part number
	1	PFP-M

■ Fiber-Optic Cables

The E3X-NA amplifiers use Omron's E32-series fiber-optic cables. With a choice of over 80 sensing heads, you are sure to find one that matches your application requirements. Refer to the selection of E32 cables (listed with their respective sensing distances) in the fiber section at the end of this data sheet. Order fiber-optic cables separately.

Specifications

■ Amplifier Units

Ratings/Characteristics

Item		Amplifier Units with Cables				Connector-ready amplifier units	
		Standard models	High-speed detection models	Mark-detecting models	Water-resistant models	Wire-saving models	Water-resistant models (use M8 connectors)
Output type	NPN output	E3X-NA11	E3X-NA11F	E3X-NAG11	E3X-NA11V	E3X-NA6	E3X-NA14V
	PNP output	E3X-NA41	E3X-NA41F	E3X-NAG41	E3X-NA41V	E3X-NA8	E3X-NA44V
Light source (wavelength)		Red LED (680 nm)		Green LED (520 nm)	Red LED (680 nm)		
Supply voltage		12 to 24 VDC $\pm 10\%$, ripple (p-p): 10% max.					
Current consumption		35 mA max.	35 mA max. (for 24-VDC power supply)	35 mA max.			
Control output		NPN/PNP (depends on model) open collector; load current: 50 mA max.; residual voltage: 1 V max.					
Operation mode	Switch-selectable	Light-ON/Dark-ON operation					
Response time		200 μ s max. for operation and reset respectively (See note.)	Operation: 20 μ s max. Reset: 30 μ s max.	200 μ s max. for operation and reset respectively (See Note.)			
Sensitivity adjustment		8-turn sensitivity adjuster (with indicator)					
Circuit protection		Reverse polarity, output short-circuit, mutual interference prevention (optically synchronized)	Reverse polarity, output short-circuit	Reverse polarity, output short-circuit, mutual interference prevention (optically synchronized)			
Timer function		OFF-delay timer: 40 ms (fixed)					
Ambient illumination (receiver side)		Incandescent lamp: 10,000 lux max. Sunlight: 20,000 lux max.					
Ambient temperature		Operating: Groups of 1 to 3 Amplifiers: -25°C to 55°C (-13°F to 131°F) Groups of 4 to 11 Amplifiers: -25°C to 50°C (-13°F to 122°F) Groups of 12 to 16 Amplifiers: -25°C to 45°C (-13°F to 113°F) with no icing or condensation Storage: -30°C to 70°C (-22°F to 158°F) with no icing or condensation					
Ambient humidity		Operating and storage: 35% to 85% (with no condensation)					
Insulation resistance		20 M Ω min. (at 500 VDC)					
Dielectric strength		1,000 VAC at 50/60 Hz for 1 minute					500 VAC at 50/60 Hz for 1 minute
Vibration resistance		10 to 55 Hz with a 1.5-mm double amplitude for 2 hrs each in X, Y and Z directions					
Shock resistance		500 m/s ² , for 3 times each in X, Y and Z directions					
Enclosure rating		IEC60529 IP50 (with Protective Cover attached)			IEC60529 IP66 (with Protective Cover attached)	IEC60529 IP50 (with Protective Cover attached)	IEC60529 IP66 (with Protective Cover attached)
Connection method		Prewired (standard cable length: 2 m)				Connector	M8 connector
Weight (packed)		Approx. 100 g			Approx. 110 g	Approx. 55 g	Approx. 65 g
Material	Case	Polybutylene terephthalate (PBT)					
	Cover	Polycarbonate			Polyethersulfone (PES)	Polycarbonate	Polyethersulfone (PES)
Accessories		Instruction Sheet					

Note: When there are 8 or more Amplifier Units mounted side-by-side, the response time will be 350 μ s max.

■ Amplifier Unit Connectors

Item		E3X-CN11	E3X-CN12
Rated current		2.5 A	
Rated voltage		50 V	
Contact resistance		20 m Ω max. (20 mVDC max., 100 mA max.) (The above figure is for connection to the Amplifier Unit and the adjacent Connector. It does not include the conductor resistance of the cable.)	
Number of insertions		50 times (for connection to the Amplifier Unit and the adjacent Connector)	
Material	Housing	Polybutylene terephthalate (PBT)	
	Contact	Phosphor bronze/gold-plated nickel	
Weight (packed)		Approx. 55 g	Approx. 25 g

Nomenclature

■ Amplifier Units

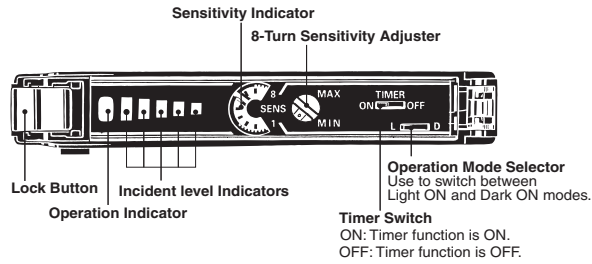

■ LED Bar Display

Indicators

In addition to an operation indicator (orange), the E3X-NA also has incident level indicators (4 green and 1 red). Use these indicators for optical axis adjustments and maintenance.

Status of indicators (in L/ON mode)	Operation indicator (in L/ON mode)	Incident level
<p>Not lit Lit (See note.)</p>	Not lit	Approx. 80% max. of operating level
	Not lit	Approx. 80% to 90% of operating level
	Not lit or lit	Approx. 90% to 110% of operating level
	Lit	Approx. 110% to 120% of operating level
	Lit	Approx. 120% min. of operating level

Note: The indicator farthest to the right will be lit even if the incident level is 0.

Operation

Output Circuits

Output	Model	Mode selector	Timing chart	State of output transistor	Output circuit
NPN	E3X-NA11 E3X-NA6 E3X-NAG11 E3X-NA11F E3X-NA11V E3X-NA14V	LIGHT ON (L/ON)	Incident light: [Pulse] → No incident light: [Low] → Operation indicator ON (orange): [Pulse] → OFF: [Low] → Output transistor: ON [High] → OFF [Low] → Load (relay): Operate [High] → Release [Low] → (Between brown and black)	Light ON	
		DARK ON (D/ON)	Incident light: [Pulse] → No incident light: [Low] → Operation indicator ON (orange): [Pulse] → OFF: [Low] → Output transistor: ON [Low] → OFF [High] → Load (relay): Operate [Low] → Release [High] → (Between brown and black)	Dark ON	<p>M8 Connector Pin Arrangement</p> <p>Note: Pin 2 is not used.</p>
PNP	E3X-NA41 E3X-NA8 E3X-NAG41 E3X-NA41F E3X-NA41V E3X-NA44V	LIGHT ON (L/ON)	Incident light: [Pulse] → No incident light: [Low] → Operation indicator ON (orange): [Pulse] → OFF: [Low] → Output transistor: ON [Low] → OFF [High] → Load (relay): Operate [Low] → Release [High] → (Between brown and black)	Light ON	
		DARK ON (D/ON)	Incident light: [Pulse] → No incident light: [Low] → Operation indicator ON (orange): [Pulse] → OFF: [Low] → Output transistor: ON [High] → OFF [Low] → Load (relay): Operate [High] → Release [Low] → (Between brown and black)	Dark ON	<p>M8 Connector Pin Arrangement</p> <p>Note: Pin 2 is not used.</p>

Connectors (Sensor I/O Connectors)

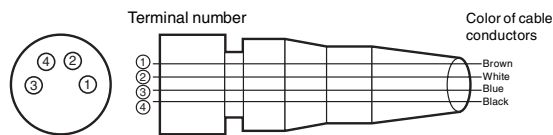

XS3F-M421-402-A, XS3F-M422-402-A
 XS3F-M421-405-A, XS3F-M422-405-A

Classification	Color of cable conductors	Connection pin number	Application
DC	Brown	1	Power supply (+V)
	White	2	---
	Blue	3	Power supply (0 V)
	Black	4	Output

Note: Pin 2 is not used.

Engineering Data (Typical)

■ Parallel Operating Range

At max. sensitivity. (Use for optical axis adjustment at installation.)

E32-TC200

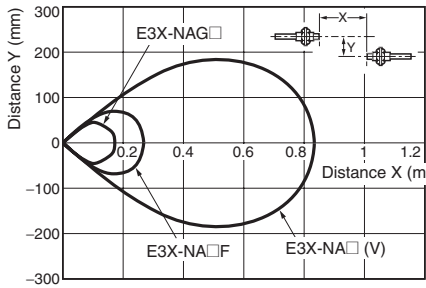

E32-T11L/T12L

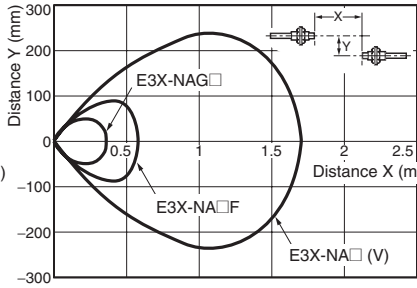

E32-T11R

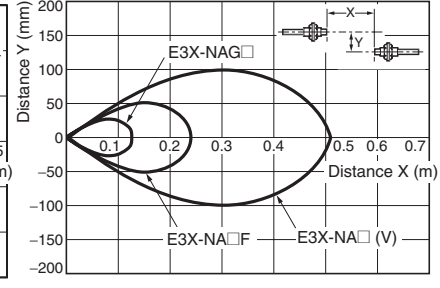

E32-T11

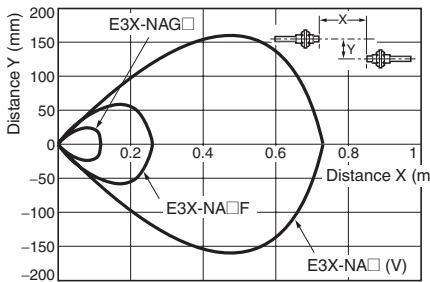

E32-TC200E

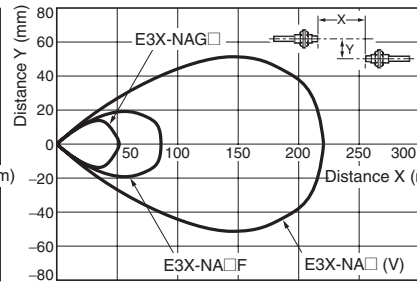

E32-T24S

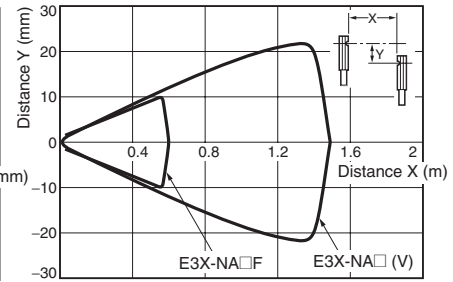

■ Operating Range

With standard sensing target at max. sensitivity. (Use for the positioning of the object and Sensor.)

E32-DC200

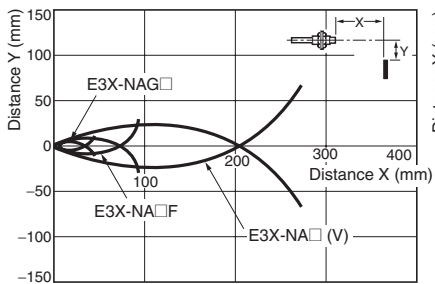

E32-D11L

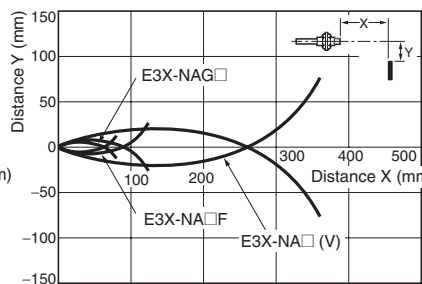

E32-D11R/D12R

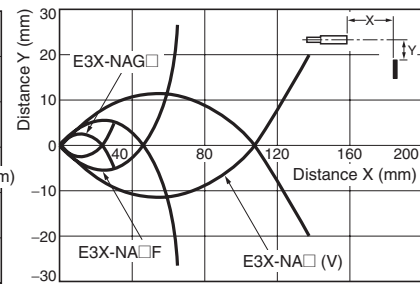

E32-DC200E

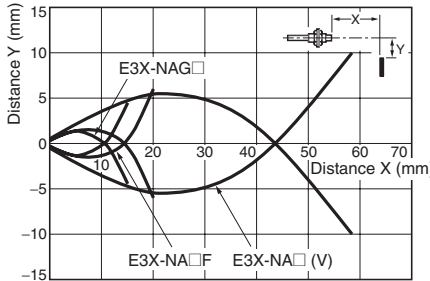

E32-D33

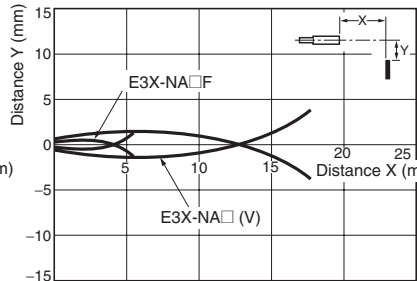

E32-L25L

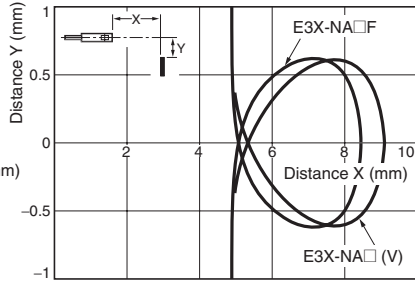

■ Number of Turns of Sensitivity Adjuster vs. Sensing Distance

E32-T11L

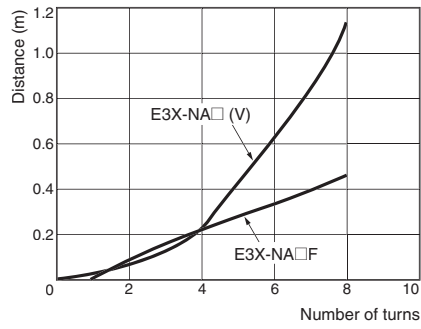

E32-D11L

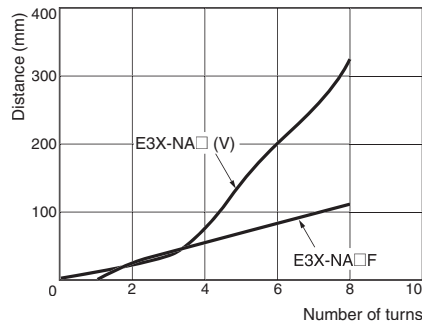

Sensing Distance vs. Hysteresis

E32-T11L

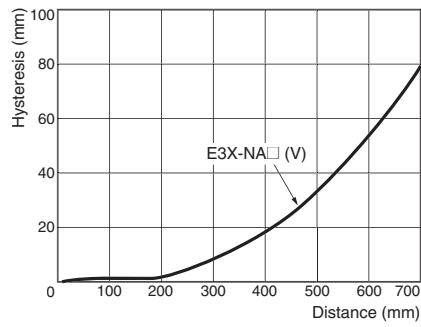

E32-D11L

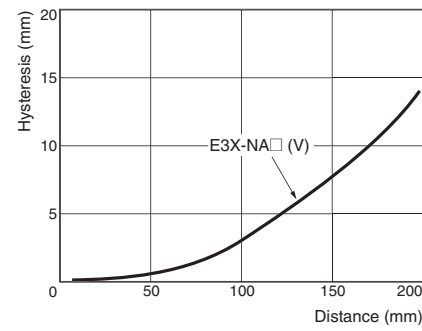

Dimensions

Unit: mm (inch)

■ Amplifier Units

Amplifier Units with Cables (with Mounting Bracket Attached)

E3X-NA11
E3X-NA11F
E3X-NA41
E3X-NA41F
E3X-NAG11
E3X-NAG41

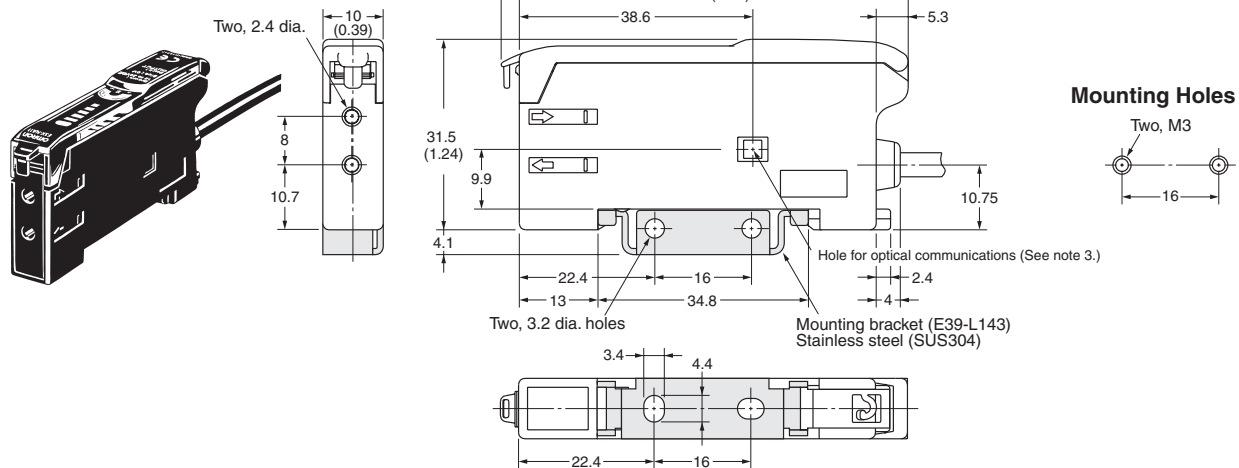

- Note:**
1. The mounting bracket can also be used on side A.
 2. With these models, a 4-dia., 3-conductor, vinyl-insulated round cable (conductor cross-sectional area: 0.45 mm^2 ; insulation diameter: 1.1 mm) is used. Standard length: 2 m.
 3. The hole for optical communications is for preventing mutual interference. There is no hole for E3X-NA□F models.

Water-Resistant Amplifier Units with Cables (with Mounting Bracket Attached)

E3X-NA11V
E3X-NA41V

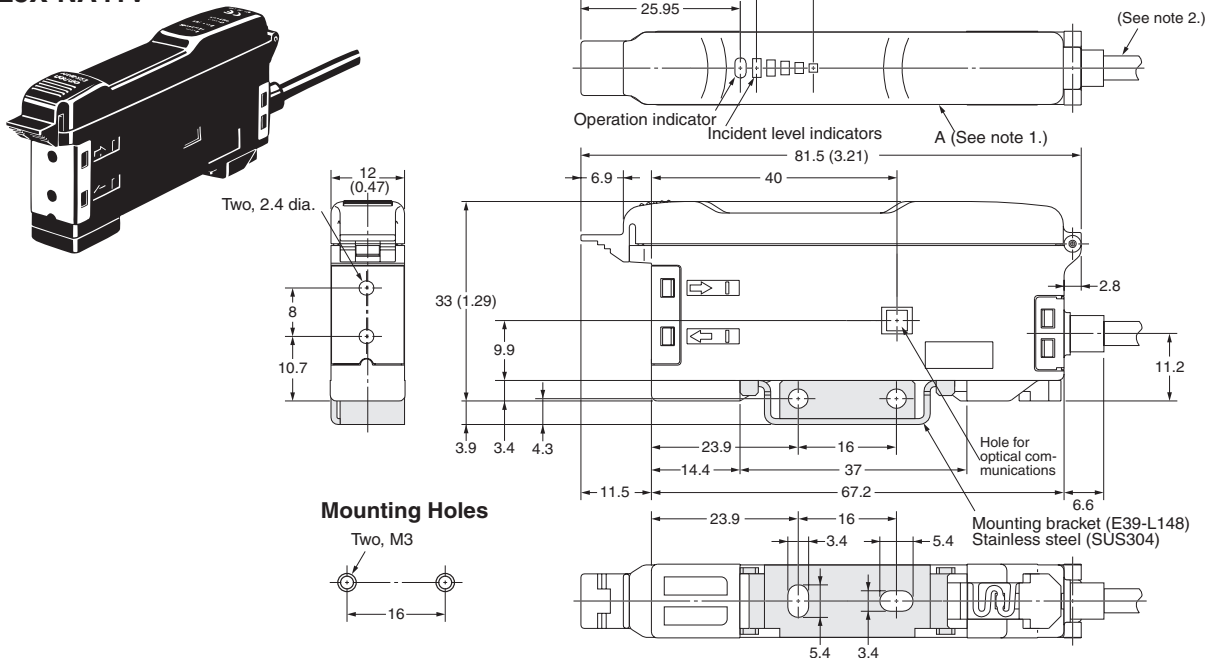

- Note:**
1. The mounting bracket can also be used on side A.
 2. With these models, a 4-dia., 3-conductor, vinyl-insulated round cable (conductor cross-sectional area: 0.45 mm^2 ; insulation diameter: 1.1 mm) is used. Standard length: 2 m.

Wire-Saving Amplifiers

E3X-NA6
E3X-NA8

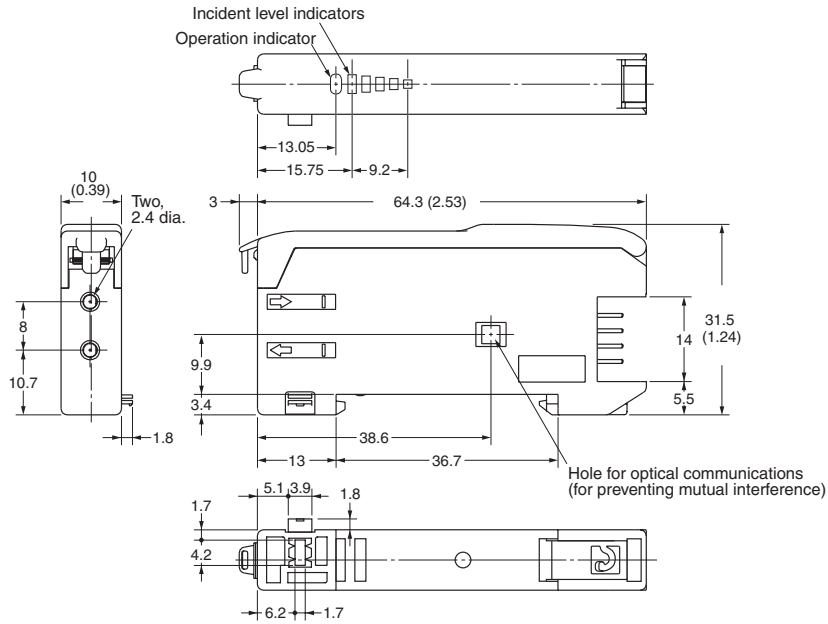
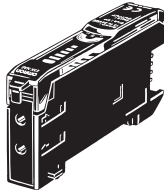

Dimensions with Master Connector Connected

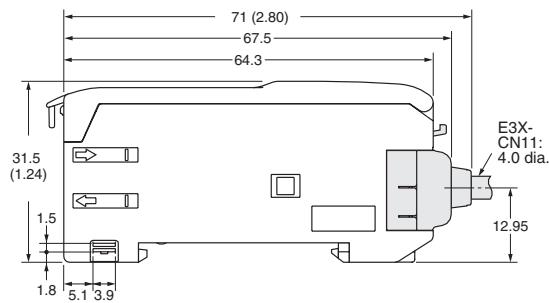

Dimensions with Slave Connector Connected

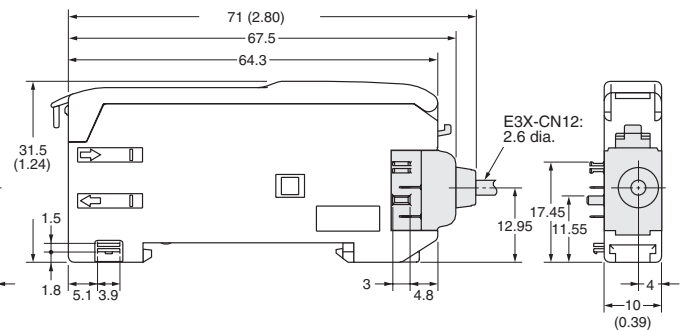

M8 Connector-Ready, Water-Resistant Amplifier Units

E3X-NA14V
E3X-NA44V

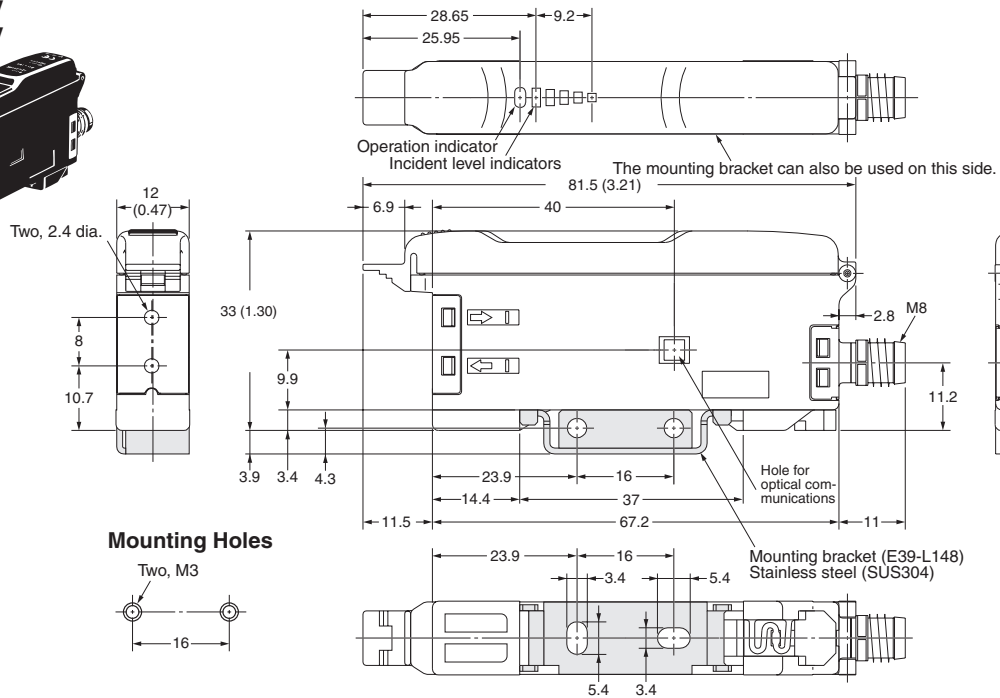
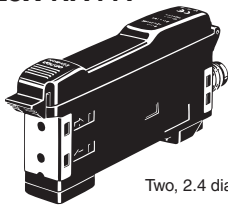

■ Amplifier Unit Connectors (Order Separately)

Master Connectors
E3X-CN11

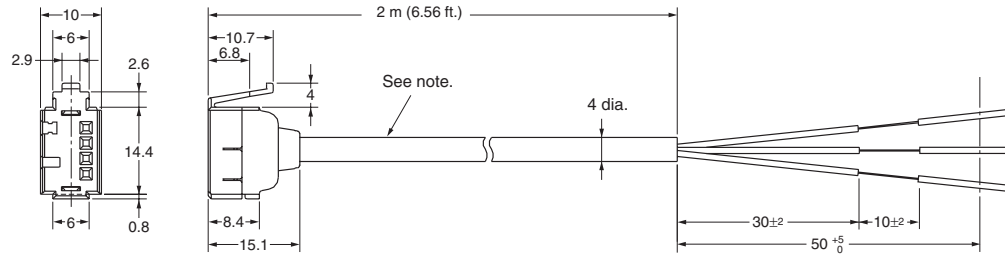
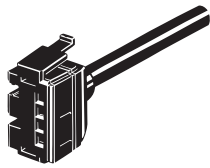

Note: A 4-dia., 3-conductor, vinyl-insulated round cable (conductor cross-sectional area: 0.2 mm²; insulation diameter: 1.1 mm) is used.

Slave Connectors
E3X-CN12

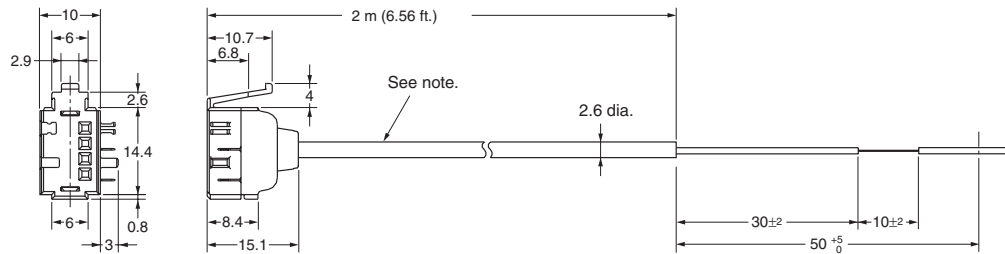
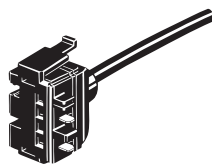

Note: A 2.6-dia., single-conductor, vinyl-insulated round cable (conductor cross-sectional area: 0.2 mm²; insulation diameter: 1.1 mm) is used.

■ Sensor I/O Connectors (Order Separately)

Straight Connector (at One End of Cable)

XS3F-M421-402-A (L=2 m)

XS3F-M421-405-A (L=5 m)

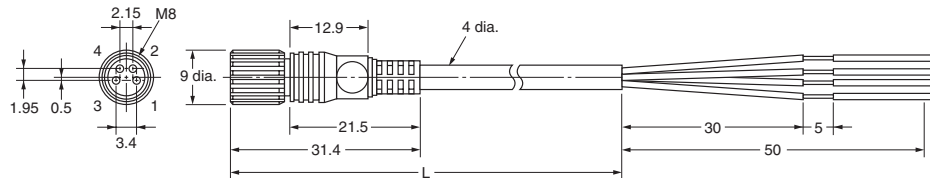

L-shaped Connector (at One End of Cable)

XS3F-M422-402-A (L=2 m)

XS3F-M422-405-A (L=5 m)

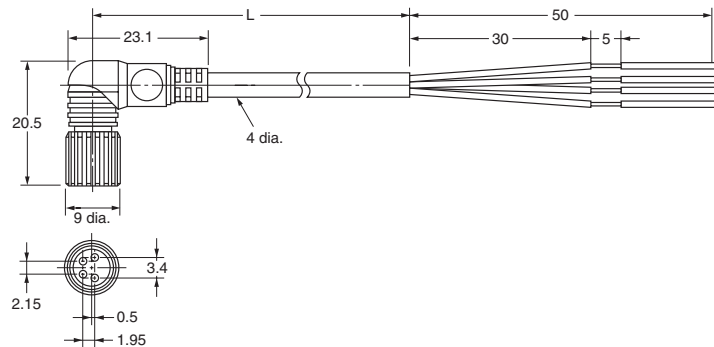
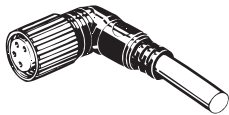

■ Accessories (Order Separately)

Mounting Bracket for E3X-NA□, E3X-NA□F, and E3X-NAG□ Models

E39-L143

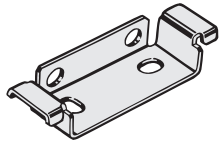

Material: Stainless steel (SUS 304)

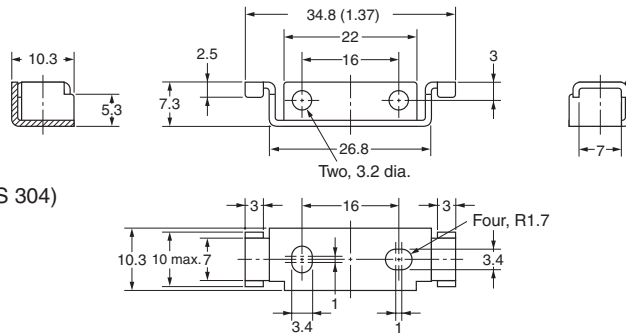

Mounting Holes

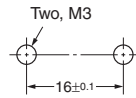

Mounting Bracket for E3X-NA□V Models

E39-L148

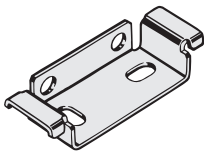

Material: Stainless steel (SUS 304)

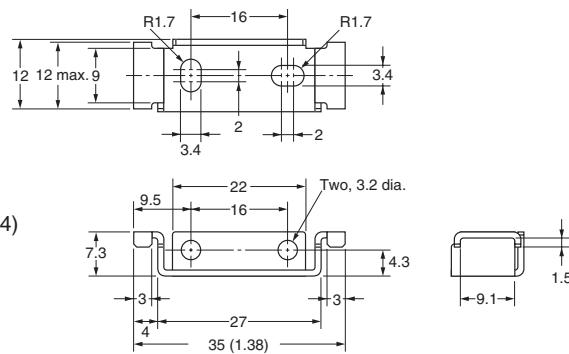

Mounting Holes

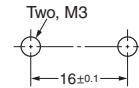

End Plate

PFP-M

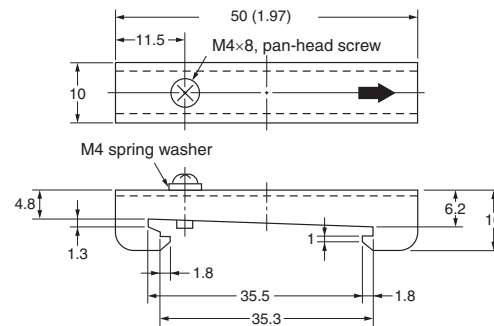
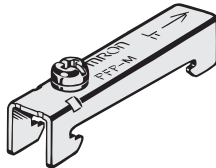

Precautions

■ Wiring Precautions

Read the following before using the Amplifier Unit and Sensor to ensure safety.

Power Supply Voltage

Do not impose any voltage exceeding the rated voltage on the E3X-NA. Do not impose AC power (100 VAC) on models that operate with DC. In both cases, the E3X-NA may burst or burn.

Load Short-circuits

Do not short-circuit the load connected to the E3X-NA, or the E3X-NA may burst or burn.

Polarity

When supplying power to the E3X-NA, make sure that the polarity of the power is correct, or the E3X-NA may burst or burn.

No-load Operation

A load must be connected to the E3X-NA during operation, or internal elements may burst or burn. Always wire through a load.

Operating Environment

- Do not use the Amplifier Unit or Sensor in places with flammable or explosive gas.
- Do not use the Amplifier Unit or Sensor underwater.
- Do not disassemble, repair, or modify the Amplifier Unit or Sensor.

■ Power

Turning Power ON

The Sensor is ready to operate within 100 ms after the power supply is turned ON. If the Sensor and load are connected to power supplies separately, be sure to turn ON the power supply to the Sensor first.

Turning Power OFF

Pulses may be output when the power is turned OFF. Always turn OFF the power to the load or the load line first.

Power Supply Type

Do not connect the E3X-NA to a full-wave or half-wave rectified power supply.

Communications Hole

The hole on the side of the Amplifier Unit is a communications hole for preventing mutual interference when Amplifier Units are mounted side-by-side. The E3X-MC11 Mobile Console (sold separately) cannot be used.

If an excessive amount of light is received via the Sensor, the mutual interference prevention function may not work. In this case, make the appropriate adjustments using the sensitivity adjuster.

The mutual interference prevention function will not operate when the E3X-NA is used side-by-side with E3X-DA-N models.

■ Wiring the Amplifier Unit

Cable

The cable can be extended, provided that the extension wire applied is at least 0.3 mm² thick and the total distance no more than 100 m.

Do not pull the cable with a force exceeding 30N.

Separation from Power or High-tension Lines

Do not wire power lines or high-tension lines alongside the lines of the Amplifier Unit in the same conduit, otherwise the Amplifier Unit may be damaged or malfunction due to induction. Be sure to wire the lines of the Amplifier Unit as far as possible from power lines or high-tension lines or laid in an exclusive, shielded conduit.

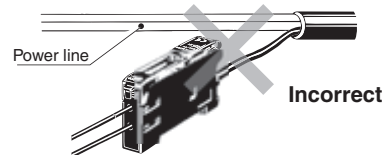

Power Supply

If a standard switching regulator is used as a power supply, the frame ground (FG) terminal and the ground (G) terminal must be grounded, or faulty operation may result from the switching noise of the power supply.

M8 Metal Connectors (Water-Resistant Models)

Turn OFF the power before inserting or removing the connector.

Hold the connector cover when inserting or removing the connector.

Tighten the fixing screws by hand. Using tools such as pliers may cause damage.

The applicable tightening torque range is 0.3 to 0.4 N·m. If tightening is insufficient, the enclosure rating may not be maintained, and vibrations may cause the connector to come loose.

■ Mounting the Amplifier Unit

Joining Amplifier Units

1. Mount the Amplifier Units one at a time onto the DIN rail.

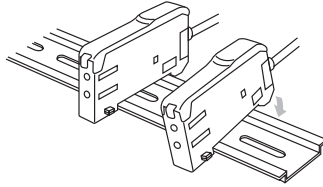

2. Line up the clips and slide the Amplifier Units together. Then press the Amplifier Units together until they click into place.

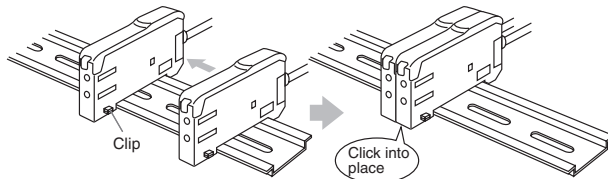

Separating Amplifier Units

Slide Amplifier Units away from each other, and remove from the DIN rail one at a time. (Do not attempt to remove Amplifier Units from the DIN rail without separating them first.)

- Note:**
1. The specifications for ambient temperature will vary according to the number of Amplifier Units used together. For details, refer to *Ratings/Characteristics* in the *Specifications* section of this data sheet.
 2. Always turn OFF the power supply before joining or separating Amplifier Units.

Mounting

1. Mount the front part on the mounting bracket E39-L143 or E39-L148 (order separately) or onto a DIN rail.
2. Press the back part onto the mounting bracket or the DIN rail.

Note: Do not mount the back of the Amplifier Unit onto the mounting bracket or the DIN rail first, or the mounting strength of the Amplifier Unit may be reduced. Always mount the front of the Amplifier Unit first.

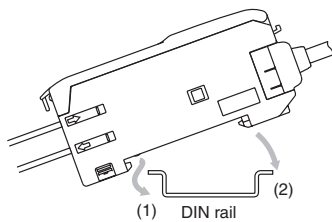

Removal

Pull the lock tab of the Amplifier Unit with a flat blade screwdriver in direction (3) and lift the fiber insertion part in direction (4) as shown below.

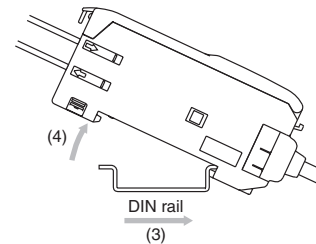

When side-mounting using a mounting bracket, secure the mounting bracket to the Amplifier Unit and then mount using M3 screws. Use plain washers of diameter 6mm or less when mounting.

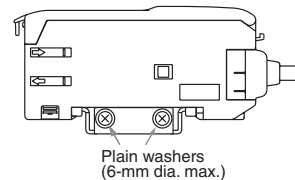

Operating Environment

Ambient Conditions

Dust or dirt accumulation on the optical communications hole may prevent normal communications. Be sure to remove any dust or dirt before using the Unit.

Ratings and Specifications

The ratings and performance specifications for items such as the minimum sensing target and characteristics are based on products taken at random from certain production lots. Use this data as reference only.

Protective Cover

Be sure to mount the Protective Cover before use.

■ Mounting the Fiber Unit

Tightening Force

The tightening force applied to the Fiber Unit should be as shown below.

Screw-Mounting Model

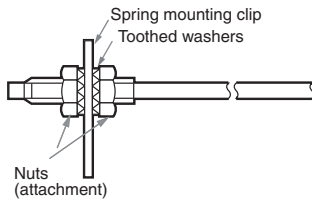

Cylindrical Model

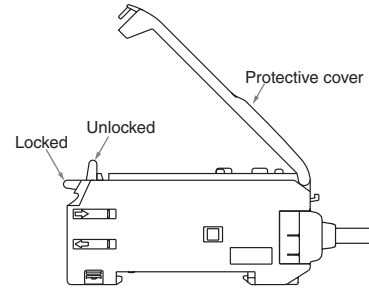
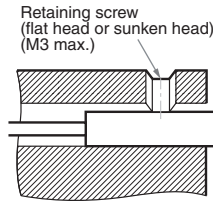

Note: To maintain the fiber properties, confirm that the lock is released before removing the fiber.

3. Precautions for Fiber Connection/Disconnection

Be sure to lock or unlock the lock button within an ambient temperature range between -10°C and 40°C .

Cutting Fiber

Insert a fiber into the Fiber Cutter and determine the length of the fiber to be cut.

Press down the Fiber Cutter in a single stroke to cut the fiber.

The cutting holes cannot be used twice. If the same hole is used twice, the cutting face of the fiber will be rough and the sensing distance will be reduced. Always use an unused hole.

Cut a thin fiber as follows:

1. An attachment is temporarily fitted to a thin fiber before shipment.

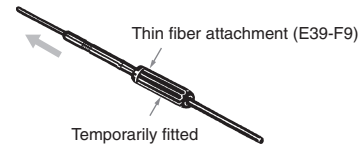

2. Secure the attachment after adjusting the position of it in the direction indicated by the arrow.



3. Insert the fiber to be cut into the E39-F4.

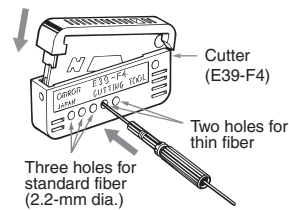

4. Finished state (proper cutting state)



Note: Insert the fiber in the direction indicated by the arrow.

Fiber Units	Clamping torque
M3/M4 screw	0.78 N·m max.
M6 screw/ 6-mm dia. cylinder	0.98 N·m max.
1.5-mm dia. cylinder	0.2 N·m max.
2-mm dia./3-mm dia. cylinder	0.29 N·m max.
E32-T12F 5-mm dia. Teflon model	0.78 N·m max.
E32-D12F 6-mm dia. Teflon model	
E32-T16	0.49 N·m max.
E32-R21	0.59 N·m max.
E32-M21	Up to 5 mm to the tip: 0.49 N·m max. More than 5 mm from the tip: 0.78 N·m max.
E32-L25A	0.78 N·m max.
E32-T16P E32-T16PR E32-T24S E32-L24L E32-L25L E32-T16J E32-T16JR	0.29 N·m max.
E32-T16W E32-T16WR	0.3 N·m max.

Use a proper-sized wrench.

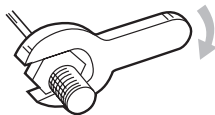

Fiber Connection and Disconnection

The E3X-NA Amplifier Unit has a lock button. Connect or disconnect the fibers to or from the E3X-NA Amplifier Unit using the following procedures:

1. Connection

Open the protective cover, insert the fibers according to the fiber insertion marks on the side of the Amplifier Unit, and lower the lock button.

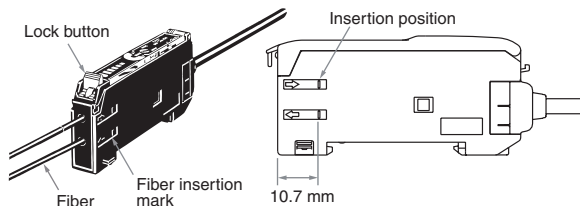

2. Disconnection

Remove the protective cover and raise the lock button to pull out the fiber.

Connection

Do not pull or press the Fiber Units. The Fiber Units have a withstand force of 9.8 N or 29.4 N maximum (pay utmost attention because the fibers are thin).

Do not bend the edge of the Fiber Units (excluding the E32-T□R and E32-D□R).

Correct

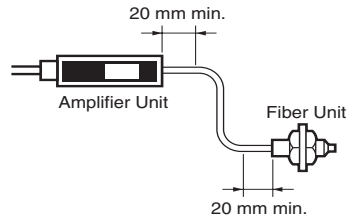

Incorrect

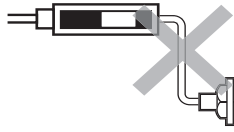

Do not apply excess force on the Fiber Units.

Correct

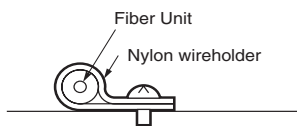

Incorrect

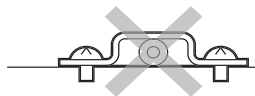

The Fiber Head could be broken by excessive vibration. Use the following method to prevent fiber head breakage:

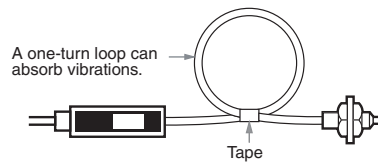

Bending Radius

E39-F11 Sleeve Bender

The bending radius of the stainless steel tube should be as large as possible. The smaller the bending radius becomes, the shorter the sensing distance will be.

Insert the tip of the stainless steel tube to the Sleeve Bender and bend the stainless steel tube slowly along the curve of the Sleeve Bender (refer to the figure).

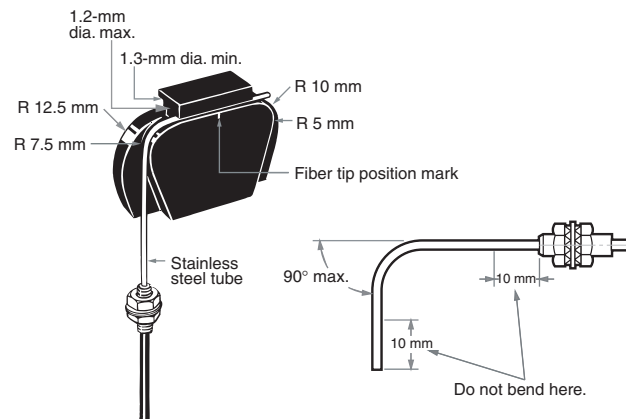

■ Mounting Amplifier Units with Connectors

Mounting Connectors

1. Insert the Master or Slave Connector into the Amplifier Unit until it clicks into place.

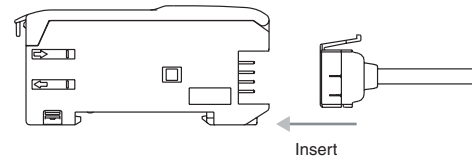

2. Join Amplifier Units together as required after all the Master and Slave Connectors have been inserted.
3. Attach the stickers (provided as accessories) to the sides of Master and Slave Connectors that are not connected to other Connectors.

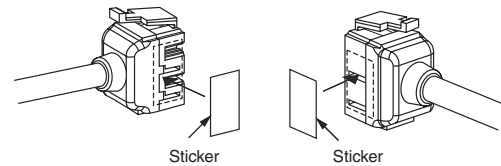

Note: Attach the stickers to the sides with grooves.

Removing Connectors

1. Slide the slave Amplifier Unit for which the Connector is to be removed away from the rest of the group.
2. After the Amplifier Unit has been separated, press down on the lever on the Connector and remove it. (Do not attempt to remove Connectors without separating them from other Amplifier Units first.)

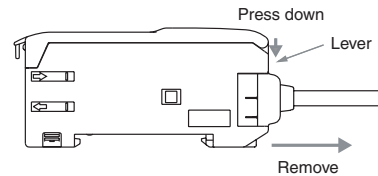

■ Mounting End Plate (PFP-M)

Depending on how it is mounted, an Amplifier Unit may move during operation. In this case, use an End Plate.

Before mounting an End Plate, remove the clip from the master Amplifier Unit using a nipper or similar tool.

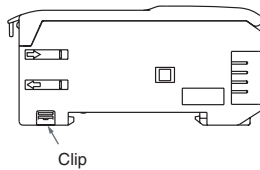

The clip can also be removed using the following mechanism, which is incorporated in the construction of the section underneath the clip.

1. Insert the clip that is to be removed into the slit underneath the clip on another Amplifier Unit.

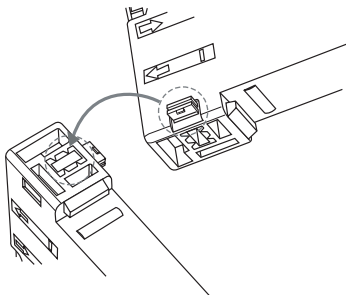

2. Remove the clip by rotating the Amplifier Unit.

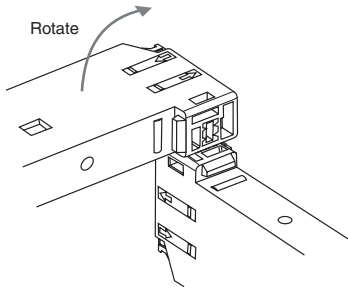

Pull Strengths for Connectors (Including Cables)

E3X-CN11: 30 N max.
E3X-CN12: 12 N max.

■ Reflector

Use of E39-R3 Reflector

Use detergent, etc., to remove any dust or oil from the surfaces where tape is applied. Adhesive tape will not be attached properly if oil or dust remains on the surface.

The E39-R3 cannot be used in places where it is exposed to oil or chemicals.

E39-F32 Protective Spiral Tubes

Insert a fiber to the Protective Spiral Tube from the head connector side (screwed) of the tube.

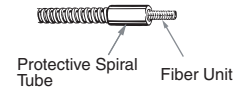

Push the fiber into the Protective Spiral Tube. The tube should be straight so that the fiber is not twisted when inserted. Then turn the end cap of the spiral tube.



Secure the Protective Spiral Tube on a suitable place with the attached nut.

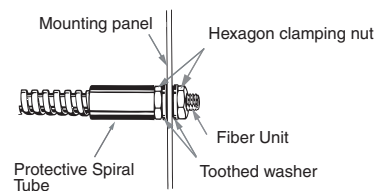

Use the attached saddle to secure the end cap of the Protective Spiral Tube. To secure the Protective Spiral Tube at a position other than the end cap, apply tape to the tube so that the portion becomes thicker in diameter.

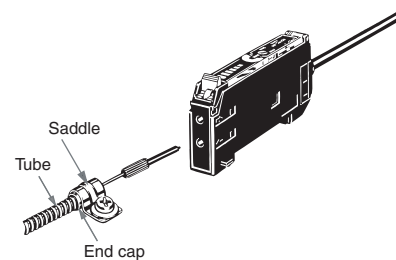

■ E39-F10 Fiber Connector

Mount the Fiber Connector as shown in the following illustrations.

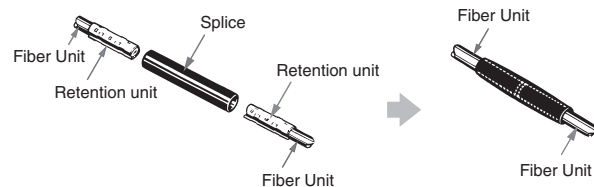

The Fiber Units should be as close as possible when they are connected.

Sensing distance will be reduced by approximately 25% when fibers are connected.

Only 2.2-mm-dia. fibers can be connected.









Sensing Distance with Fiber Optic Cables

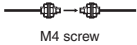
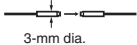

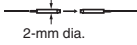

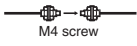

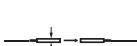
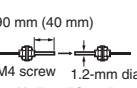

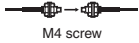

■ Through-beam Fiber Units

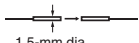

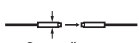

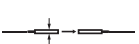
Refer to the end of the following table for notes and precautions.

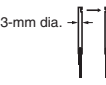
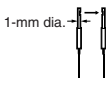
(Free-cut) Indicates models that allow free cutting. Models without this mark do not allow free cutting.

■ : Red light □ : Green light

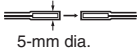
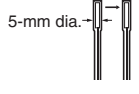
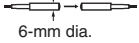
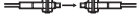
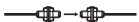
Application	Features	Appearance	Applicable Amplifier Unit	Sensing distance (mm) (Values in parentheses: when using the E39-F1 Lens Unit)	Standard object (see notes) (min. sensing target: opaque)	Part number	Permissible bending radius		
Long distance	M4 (Free-cut)		E3X-NA□ (V)	■ 700 (2,000)	1.4-mm dia. (0.03-mm dia.)	E32-T11L	25 mm		
			E3X-NAG□	□ 130 (370)					
			E3X-NA□F	■ 210 (600)	1.4-mm dia. (0.5-mm dia.)				
	3-mm dia. (Free-cut)			E3X-NA□ (V)	■ 700	1.4-mm dia. (0.03-mm dia.)	E32-T12L		
				E3X-NAG□	□ 130				
				E3X-NA□F	■ 210	1.4-mm dia. (0.5-mm dia.)			
	M3 (Free-cut)			E3X-NA□ (V)	■ 200	0.9-mm dia. (0.03-mm dia.)	E32-T21L	10 mm	
				E3X-NAG□	□ 40				
				E3X-NA□F	■ 60	0.9-mm dia. (0.2-mm dia.)			
		2-mm dia.; small diameter (Free-cut)			E3X-NA□ (V)	■ 200	0.9-mm dia. (0.03-mm dia.)	E32-T22L	
					E3X-NAG□	□ 40			
					E3X-NA□F	■ 60	0.9-mm dia. (0.2-mm dia.)		
M14; with lens; ideal for explosion-proof applications (Free-cut)			E3X-NA□ (V)	■ 14,000	10-mm dia. (0.1-mm dia.)	E32-T17L	25 mm		
			E3X-NA□F	■ 4,200	10-mm dia. (1.5-mm dia.)				
General-purpose	M4 (Free-cut)			E3X-NA□ (V)	■ 400 (3,000)	1.0-mm dia. (0.03-mm dia.)	E32-TC200	25 mm	
				E3X-NAG□	□ 75 (550)				
				E3X-NA□F	■ 120 (900)	1.0-mm dia. (0.2-mm dia.)			
	M3; possible to mount the reflective side-view conversion attachment E39-F5 (Free-cut)				E3X-NA□ (V)	■ 360	1.0-mm dia. (0.03-mm dia.)	E32-TC200A	25 mm
					E3X-NAG□	□ 65			
					E3X-NA□F	■ 100	1.0-mm dia. (0.2-mm dia.)		
	M3; for detecting minute sensing targets (Free-cut)				E3X-NA□ (V)	■ 100	0.5-mm dia. (0.03-mm dia.)	E32-TC200E	10 mm
					E3X-NAG□	□ 20			
					E3X-NA□F	■ 30	0.5-mm dia. (0.1-mm dia.)		
Thin fiber	2-mm dia.; for detecting minute sensing targets (Free-cut)			E3X-NA□ (V)	■ 100	0.5-mm dia. (0.03-mm dia.)	E32-T22	10 mm	
				E3X-NAG□	□ 20				
				E3X-NA□F	■ 30	0.5-mm dia. (0.1-mm dia.)			
	1.2-mm dia.; with sleeve (Free-cut)	90 mm (40 mm)  M4 screw 1.2-mm dia. (): E32-TC200B4			E3X-NA□ (V)	■ 400	1.0-mm dia. (0.03-mm dia.)	E32-TC200B E32-TC200B4	25 mm
					E3X-NAG□	□ 75			
					E3X-NA□F	■ 120	1.0-mm dia. (0.2-mm dia.)		
	0.9-mm dia.; with sleeve (Free-cut)	90 mm (40 mm)  M3 screw 0.9-mm dia. (): E32-TC200F4			E3X-NA□ (V)	■ 100	0.5-mm dia. (0.03-mm dia.)	E32-TC200F E32-TC200F4	10 mm
					E3X-NAG□	□ 20			
					E3X-NA□F	■ 30	0.5-mm dia. (0.1-mm dia.)		

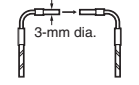
Application	Features	Appearance	Applicable Amplifier Unit	Sensing distance (mm) (Values in parentheses: when using the E39-F1 Lens Unit)	Standard object (see notes) (min. sensing target: opaque)	Part number	Permissible bending radius
Flexible (R4)	Ideal for mounting on moving sections (R4) (Free-cut)	 M4 screw	E3X-NA□ (V)	360	1.0-mm dia. (0.03-mm dia.)	E32-T11	4 mm
			E3X-NAG□	65			
			E3X-NA□F	100			
		 M3 screw	E3X-NA□ (V)	100	0.5-mm dia. (0.03-mm dia.)	E32-T21	
			E3X-NAG□	18			
			E3X-NA□F	30			
		 1.5-mm dia.	E3X-NA□ (V)	100	0.5-mm dia. (0.03-mm dia.)	E32-T22B	
			E3X-NAG□	18			
			E3X-NA□F	30			
	M4 (Free-cut)	 M4 screw	E3X-NA□ (V)	280 (2,100)	1.0-mm dia. (0.03-mm dia.)	E32-T11R	1 mm
			E3X-NAG□	50 (375)			
			E3X-NA□F	80 (600)			
	3-mm dia. (Free-cut)	 3-mm dia.	E3X-NA□ (V)	280 (2,100)	1.0-mm dia. (0.03-mm dia.)	E32-T12R	1 mm
			E3X-NAG□	50 (375)			
			E3X-NA□F	80 (600)			
M3; small diameter (Free-cut)	 M3 screw	E3X-NA□ (V)	60	0.5-mm dia. (0.03-mm dia.)	E32-T21R	1 mm	
		E3X-NAG□	12				
		E3X-NA□F	18				
2-mm dia.; small diameter (Free-cut)	 2-mm dia.	E3X-NA□ (V)	60	0.5-mm dia. (0.03-mm dia.)	E32-T22R	1 mm	
		E3X-NAG□	18				
		E3X-NA□F	18				
Side-view	Long distance; space-saving (Free-cut)	 3-mm dia.	E3X-NA□ (V)	240	1.0-mm dia. (0.03-mm dia.)	E32-T14L	25 mm
			E3X-NAG□	45			
			E3X-NA□F	70			
	Space-saving (Free-cut)	 3-mm dia.	E3X-NA□ (V)	110	1.0-mm dia. (0.03-mm dia.)	E32-T14LR	1 mm
			E3X-NA□F	33			
	Suitable for detecting minute sensing targets (Free-cut)	 1-mm dia.	E3X-NA□ (V)	90	0.5-mm dia. (0.03-mm dia.)	E32-T24	10 mm
			E3X-NAG□	12			
			E3X-NA□F	27			
	Suitable for detecting minute sensing targets (Free-cut)	 1-mm dia.	E3X-NA□ (V)	30	0.5-mm dia. (0.03-mm dia.)	E32-T24R	1 mm
			E3X-NA□F	9			
	Screw-mounting type (Free-cut)		E3X-NA□ (V)	1,800	4.0-mm dia. (0.03-mm dia.)	E32-T14	25 mm
			E3X-NAG□	330			
			E3X-NA□F	540			

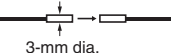
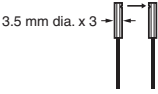
Application	Features	Appearance	Applicable Amplifier Unit	Sensing distance (mm) (Values in parentheses: when using the E39-F1 Lens Unit)	Standard object (see notes) (min. sensing target: opaque)	Part number	Permissible bending radius	
Chemical-resistant	Teflon-covered *1; withstands chemicals and harsh environments (operating ambient temperature: -30°C to 70°C) (Free-cut)	 5-mm dia.	E3X-NA□ (V)		4.0-mm dia. (0.2-mm dia.)	E32-T12F	40 mm	
			E3X-NAG□	300				
			E3X-NA□F	480	4.0-mm dia. (0.7-mm dia.)			
	Teflon-covered *1; side-view; withstands chemicals and harsh environments (operating ambient temperature: -30°C to 70°C) (Free-cut)	 5-mm dia.	E3X-NA□ (V)	200	3.0-mm dia. (0.2-mm dia.)	E32-T14F	10 mm	
			E3X-NAG□	37				
			E3X-NA□F	60	3.0-mm dia. (0.7-mm dia.)			
	Teflon *1; withstands chemicals and harsh environments (operating ambient temperature: -40°C to 200°C)	 6-mm dia.	E3X-NA□ (V)	350	1.0-mm dia. (0.2-mm dia.)	E32-T81F	10 mm	
			E3X-NA□F	100	1.0-mm dia. (0.5-mm dia.)			
	Heat-resistant	Resists 200°C; flexible (R10); fiber sheath material: Teflon *1 (operating ambient temperature: -40°C to 200°C)	 M4 screw	E3X-NA□ (V)	180	1.0-mm dia. (0.2-mm dia.)	E32-T81R	10 mm
E3X-NA□F				50	1.0-mm dia. (0.5-mm dia.)			
Resists 150°C *2; fiber sheath material: fluororesin (operating ambient temperature: -40°C to 150°C) (Free-cut)		 M4 screw	E3X-NA□ (V)	400	1.5-mm dia. (0.03-mm dia.)	E32-T51	35 mm	
			E3X-NA□F	120	1.5-mm dia. (1.0-mm dia.)			
Resists 300°C *3, with spiral tube; high mechanical strength; fiber sheath material: stainless steel (operating ambient temperature: -40°C to 300°C)		 M4 screw	E3X-NA□ (V)	300 (3,000)	1.0-mm dia. (0.03-mm dia.)	E32-T61	25 mm	
			E3X-NA□F	90	1.0-mm dia. (0.5-mm dia.)			
Side-view; resists 150°C *2; suitable for detecting minute sensing targets; fiber sheath material: fluororesin (operating ambient temperature: -40°C to 150°C) (Free-cut)		 2-mm dia.	E3X-NA□ (V)	130	1.0-mm dia. (0.03-mm dia.)	E32-T54	35 mm	
			E3X-NA□F	35	1.0-mm dia. (0.3-mm dia.)			
Resists 200°C *3; L-shaped; fiber sheath material: stainless steel		 3-mm dia.	E3X-NA□ (V)	700	1.7-mm dia. (0.03-mm dia.)	E32-T84S	25 mm	
			E3X-NA□F	210	1.7-mm dia. (0.4-mm dia.)			
Slot sensor		Suitable for film sheet detection; no optical axis adjustment required; easy to mount (Free-cut)		E3X-NA□ (V)	10	4.0-mm dia. (0.1-mm dia.)	E32-G14	25 mm
				E3X-NAG□	10			
	E3X-NA□F			10	4.0-mm dia. (1.0-mm dia.)			
Narrow vision field	Suitable for detecting wafers (Free-cut)	 3-mm dia.	E3X-NA□ (V)	1,000	1.7-mm dia. (0.5-mm dia.)	E32-T22S	10 mm	
			E3X-NA□F	300				
	Side-view; suitable for detecting wafers (Free-cut)	 3.5 mm dia. x 3	E3X-NA□ (V)	700	2.0-mm dia. (0.03-mm dia.)	E32-T24S	10 mm	
			E3X-NA□F	210	2.0-mm dia. (0.5-mm dia.)			

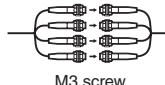
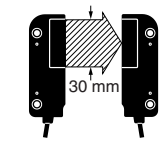
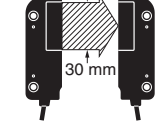
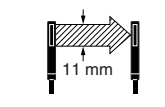
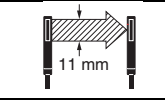
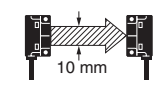
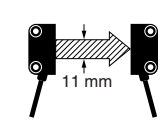
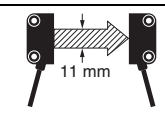
Application	Features	Appearance	Applicable Amplifier Unit	Sensing distance (mm) (Values in parentheses: when using the E39-F1 Lens Unit)	Standard object (see notes) (min. sensing target: opaque)	Part number	Permissible bending radius
Area sensing	Multi-point detection (4-head)	 M3 screw	E3X-NA□(V)	300	2.0-mm dia. (0.03-mm dia.)	E32-M21	25 mm
			E3X-NA□F	90	2.0-mm dia. (0.3-mm dia.)		
	Detects in a 30-mm area (Free-cut)	 30 mm	E3X-NA□(V)	920	(0.5-mm dia.) *4	E32-T16W	10 mm
			E3X-NAG□	170			
			E3X-NA□F	270	(4.0-mm dia.) *4		
	Detects in a 30-mm area; flexible (Free-cut)	 30 mm	E3X-NA□(V)	690	(0.5-mm dia.) *4	E32-T16WR	1 mm
			E3X-NA□F	200	(4.0-mm dia.) *4		
	Side-view; suitable for applications with limited spatial depth (Free-cut)	 11 mm	E3X-NA□(V)	520	(0.3-mm dia.) *4	E32-T16J	10 mm
			E3X-NAG□	95			
			E3X-NA□F	150	(2.0-mm dia.) *4		
Side-view; suitable for applications with limited spatial depth; flexible (Free-cut)	 11 mm	E3X-NA□(V)	390	(0.3-mm dia.) *4	E32-T16JR	1 mm	
		E3X-NA□F	110	(2.0-mm dia.) *4			
Suitable for detecting over a 10-mm area; long distance (Free-cut)	 10 mm	E3X-NA□(V)	1,500	(0.9-mm dia.) *4	E32-T16	25 mm	
		E3X-NAG□	275				
		E3X-NA□F	450	(1.5-mm dia.) *4			
Stable for detecting minute sensing targets in a wide area; enclosure rating: IEC 60529 IP50 (Free-cut)	 11 mm	E3X-NA□(V)	600	(0.3-mm dia.) *4	E32-T16P	10 mm	
		E3X-NAG□	110				
		E3X-NA□F	180	(2.0-mm dia.) *4			
Stable for detecting minute objects in a wide area; flexible; enclosure rating: IEC60529 IP50 (Free-cut)	 11 mm	E3X-NA□(V)	450	(0.3-mm dia.) *4	E32-T16PR	1 mm	
		E3X-NA□F	130	(2.0-mm dia.) *4			

*1 Teflon is a registered trademark of the Dupont Company and the Mitsui Dupont Chemical Company for their fluoride resin.

*2 For continuous operation, use the products within a temperature range of -40°C to 130°C.

*3 Indicates the heat-resistant temperature at the fiber tip.

*4 These figures are for a sensing distance of 100 mm. (Diameters of sensing targets are ones at a stationary state.)

Note: 1. The size of standard sensing target is the same as the fiber core diameter (lens diameter for models with lens).

2. The values of the minimum sensing target for E3X-NA□(V) and E3X-NAG□ through-beam models indicate those obtained where the sensing distance and sensitivity are set to optimum values.





3. The value of the minimum sensing target for E3X-NA□F through-beam models indicates that obtained at the rated sensing distance with the sensitivity set to the optimum value.









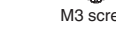
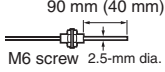
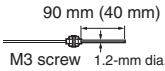
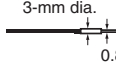
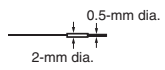



■ Fiber Units with Reflective Sensors



Refer to the end of the following table for notes and precautions.







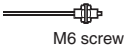
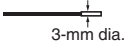
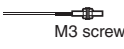
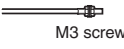
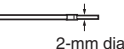
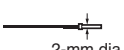
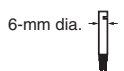
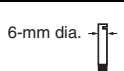
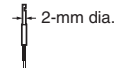
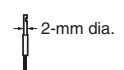

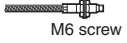
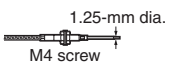

(Free-cut) Indicates models that allow free cutting. Models without this mark do not allow free cutting.

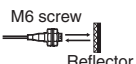
■ : Red light □ : Green light

Application	Features	Appearance	Applicable Amplifier Unit	Sensing distance (mm) *1	Standard object (see note) (min. sensing target: Gold wire)	Part number	Permissible bending radius	
Long distance	M6 (Free-cut)	 M6 screw	E3X-NA□ (V) ■	200	250×250 (0.01-mm dia.)	E32-D11L	25 mm	
			E3X-NAG□ □	35	50×50 (0.1-mm dia.)			
			E3X-NA□F ■	65	100×100 (0.015-mm dia.)			
	3-mm dia.; small diameter (Free-cut)	 3-mm dia.	E3X-NA□ (V) ■	120	150×150 (0.01-mm dia.)	E32-D12	25 mm	
			E3X-NAG□ □	20	25×25 (0.1-mm dia.)			
			E3X-NA□F ■	40	50×50 (0.015-mm dia.)			
	M4 (Free-cut)	 M4 screw	E3X-NA□ (V) ■	50	100×100 (0.01-mm dia.)	E32-D21L	10 mm	
			E3X-NAG□ □	10	25×25 (0.1-mm dia.)			
			E3X-NA□F ■	17	25×25 (0.015-mm dia.)			
		3-mm dia.; small diameter (Free-cut)	 3-mm dia.	E3X-NA□ (V) ■	50	100×100 (0.01-mm dia.)	E32-D22L	10 mm
				E3X-NAG□ □	10	25×25 (0.1-mm dia.)		
				E3X-NA□F ■	17	25×25 (0.015-mm dia.)		
General-purpose	M6 (Free-cut)	 M6 screw	E3X-NA□ (V) ■	150	200×200 (0.01-mm dia.)	E32-DC200	25 mm	
			E3X-NAG□ □	25	50×50 (0.1-mm dia.)			
			E3X-NA□F ■	50	75×75 (0.015-mm dia.)			
	M3; small diameter (Free-cut)	 M3 screw	E3X-NA□ (V) ■	36	50×50 (0.01-mm dia.)	E32-DC200E	10 mm	
			E3X-NAG□ □	6	25×25 (0.1-mm dia.)			
			E3X-NA□F ■	12	25×25 (0.02-mm dia.)			
Thin fiber	2.5-mm dia.; with sleeve (Free-cut)	 90 mm (40 mm) M6 screw 2.5-mm dia. (): E32-DC200B4	E3X-NA□ (V) ■	150	200×200 (0.01-mm dia.)	E32-DC200B E32-DC200B4	25 mm	
			E3X-NAG□ □	25	50×50 (0.1-mm dia.)			
			E3X-NA□F ■	50	75×75 (0.015-mm dia.)			
	1.2-mm dia.; with sleeve (Free-cut)	 90 mm (40 mm) M3 screw 1.2-mm dia. (): E32-DC200F4	E3X-NA□ (V) ■	36	50×50 (0.01-mm dia.)	E32-DC200F E32-DC200F4	10 mm	
			E3X-NAG□ □	6	25×25 (0.1-mm dia.)			
			E3X-NA□F ■	12	25×25 (0.02-mm dia.)			
	0.8-mm dia.; for detecting minute sensing targets (Free-cut)	 3-mm dia. 0.8-mm dia.	E3X-NA□ (V) □	10	25×25 (0.01-mm dia.)	E32-D33	4 mm	
			E3X-NA□F □	3.3	25×25 (0.03-mm dia.)			
	0.5-mm dia.; for detecting minute sensing targets (Free-cut)	 0.5-mm dia. 2-mm dia.	E3X-NA□ □	1.5	25×25 (0.01-mm dia.)	E32-D331	4 mm	
			E3X-NA□F □	0.5	25×25 (0.05-mm dia.)			

Application	Features	Appearance	Applicable Amplifier Unit	Sensing distance (mm) *1	Standard object (see note) (min. sensing target: Gold wire)	Part number	Permissible bending radius
Flexible	Ideal for mounting on moving sections 	 M6 screw	E3X-NA□(V)	90	150×150 (0.01-mm dia.)	E32-D11	4 mm
			E3X-NAG□	15	25×25 (0.1-mm dia.)		
			E3X-NA□F	30	50×50 (0.015-mm dia.)		
		 M3 screw	E3X-NA□(V)	15	25×25 (0.01-mm dia.)	E32-D21	
			E3X-NA□F	15	25×25 (0.02-mm dia.)		
			 M4 screw	E3X-NA□(V)	15		
	E3X-NAG□	2.4		25×25 (0.1-mm dia.)			
	E3X-NA□F	15		25×25 (0.02-mm dia.)			
	 1.5-mm dia.	E3X-NA□(V)	7	25×25 (0.01-mm dia.)	E32-D22B		
		E3X-NA□F	2.3	25×25 (0.02-mm dia.)			
	M6 	 M6 screw	E3X-NA□(V)	90	150×150 (0.01-mm dia.)	E32-D11R	1 mm
			E3X-NAG□	15	25×25 (0.1-mm dia.)		
			E3X-NA□F	30	50×50 (0.02-mm dia.)		
	3-mm dia. 	 3-mm dia.	E3X-NA□(V)	90	150×150 (0.01-mm dia.)	E32-D12R	
E3X-NAG□			15	25×25 (0.1-mm dia.)			
E3X-NA□F			30	50×50 (0.02-mm dia.)			
M3; small diameter 	 M3 screw	E3X-NA□(V)	15	25×25 (0.01-mm dia.)	E32-D21R		
		E3X-NA□F	5	25×25 (0.03-mm dia.)			
3-mm dia.; small diameter 	 3-mm dia.	E3X-NA□(V)	15	25×25 (0.01-mm dia.)	E32-D22R		
		E3X-NA□F	15	25×25 (0.03-mm dia.)			

Application	Features	Appearance	Applicable Amplifier Unit	Sensing distance (mm) *1	Standard object (see note) (min. sensing target: Gold wire)	Part number	Permissible bending radius		
Coaxial	M6 coaxial; high-precision positioning (Free-cut)	 M6 screw	E3X-NA□ (V)	150	200×200 (0.01-mm dia.)	E32-CC200	25 mm		
			E3X-NAG□	25	50×50 (0.1-mm dia.)				
			E3X-NA□F	50	75×75 (0.015-mm dia.)				
	3-mm dia. coaxial; small diameter; high-precision positioning (Free-cut)	 3-mm dia.	E3X-NA□ (V)	80	100×100 (0.01-mm dia.)	E32-D32L			
			E3X-NAG□	12	25×25 (0.1-mm dia.)				
			E3X-NA□F	25	50×50 (0.02-mm dia.)				
	M3 coaxial; high-precision positioning; possible to mount small-spot lens (E39-F3A-5/F3B/F3C) (Free-cut)	 M3 screw	E3X-NA□ (V)	40	50×50 (0.01-mm dia.)	E32-C31			
			E3X-NAG□	16	25×25 (0.1-mm dia.)				
			E3X-NA□F	13	25×25 (0.02-mm dia.)				
	M3 coaxial; high-precision positioning; possible to mount small-spot lens (E39-F3A-5/F3B/F3C)	 M3 screw	E3X-NA□ (V)	15	25×25 (0.01-mm dia.)	E32-C41			
			E3X-NA□F	15	25×25 (0.02-mm dia.)				
	2-mm dia. coaxial; high-precision positioning; possible to mount small-spot (0.1 to 0.6 dia.) lens (E39-F3A)	 2-mm dia.	E3X-NA□ (V)	15	25×25 (0.01-mm dia.)	E32-C42			
E3X-NA□F			15	25×25 (0.02-mm dia.)					
2-mm dia. coaxial; high-precision positioning; possible to mount small-spot (0.5 to 1 dia.) lens (E39-F3A) (Free-cut)	 2-mm dia.	E3X-NA□ (V)	40	50×50 (0.01-mm dia.)	E32-D32				
		E3X-NAG□	16	25×25 (0.1-mm dia.)					
		E3X-NA□F	13	25×25 (0.02-mm dia.)					
Side-view	6-mm dia.; long distance (Free-cut)	 6-mm dia.	E3X-NA□ (V)	40	50×50 (0.03-mm dia.)	E32-D14L	25 mm		
			E3X-NAG□	10	25×25 (0.3-mm dia.)				
			E3X-NA□F	13	25×25 (0.03-mm dia.)				
	6-mm dia.; flexible (Free-cut)	 6-mm dia.	E3X-NA□ (V)	16	25×25 (0.03-mm dia.)	E32-D14LR		1 mm	
			E3X-NA□F	15					
	2-mm dia.; small diameter; flexible, space-saving (Free-cut)	 2-mm dia.	E3X-NA□ (V)	15	25×25 (0.03-mm dia.)	E32-D24		10 mm	
			E3X-NAG□	2.4	25×25 (0.3-mm dia.)				
			E3X-NA□F	15	25×25 (0.03-mm dia.)				
	2-mm dia.; small diameter space-saving; flexible (Free-cut)	 2-mm dia.	E3X-NA□ (V)	7	25×25 (0.03-mm dia.)	E32-D24R		1 mm	
			E3X-NA□F	12.3					
	Chemical-resistant	Teflon-covered *3; withstands chemicals and harsh environments (operating ambient temperature: -30°C to 70°C) (Free-cut)	 6-mm dia.	E3X-NA□ (V)	50	100×100 (0.03-mm dia.)		E32-D12F	40 mm
				E3X-NAG□	18	25×25 (0.3-mm dia.)			
E3X-NA□F				16	25×25 (0.03-mm dia.)				

Application	Features	Appearance	Applicable Amplifier Unit	Sensing distance (mm) *1	Standard object (see note) (min. sensing target: Gold wire)	Part number	Permissible bending radius
Heat-resistant	Resists 150°C *2; fiber sheath material: fluororesin (operating ambient temperature: -40°C to 150°C) (Free-cut)	 M6 screw	E3X-NA□ (V)	120	150×150 (0.03-mm dia.)	E32-D51	35 mm
			E3X-NA□F	40	50×50 (0.03-mm dia.)		
	Resists 300°C *4; fiber sheath material: stainless steel (operating ambient temperature: -40°C to 300°C)	 M6 screw	E3X-NA□ (V)	45	100×100 (0.03-mm dia.)	E32-D61	25 mm
			E3X-NA□F	15	25×25 (0.03-mm dia.)		
	Resists 400°C *4; fiber sheath material: stainless steel (operating ambient temperature: -40°C to 400°C)	 1.25-mm dia. M4 screw	E3X-NA□ (V)	30	50×50 (0.03-mm dia.)	E32-D73	25 mm
			E3X-NA□F	10	25×25 (0.03-mm dia.)		
Area sensing	Side-view; detection over wide areas (Free-cut)		E3X-NA□ (V)	75	100×100 (0.03-mm dia.)	E32-D36P1	25 mm
			E3X-NA□F	25	50×50 (0.03-mm dia.)		
Retroreflective	Transparent object detection; polarized (Free-cut)	 M6 screw Reflector E39-R3	E3X-NA□ (V)	10 to 250	35-mm dia. (0.3-mm dia.)	E32-R21 +E39-R3 (Attachment)	10 mm
			E3X-NA□F	10 to 250	35-mm dia. (0.5-mm dia.)		
	Transparent object detection, polarized (operating ambient temperature: -25°C to 55°C); enclosure rating: IEC 60529 IP66 (Free-cut)	 Reflector E39-R1	E3X-NA□ (V)	150 to 1,500	35-mm dia. (0.6-mm dia.)	E32-R16 +E39-R1 (Attachment)	25 mm
			E3X-NA□F	150 to 1,000	35-mm dia. (4.0-mm dia.)		
Limited reflective	Suitable for positioning crystal glass (Free-cut)		E3X-NA□ (V)	4 to 12	---	E32-L56E1 E32-L56E2	35 mm
			E3X-NA□F	4 to 12	---		
	Detects wafers and small differences in height; (operating ambient temperature: -40°C to 105°C); enclosure rating: IEC 60529 IP50 (Free-cut)		E3X-NA□ (V)	4±2	25×25 (0.015-mm dia.)	E32-L24L	10 mm
			E3X-NA□F	4±2	25×25 (0.03-mm dia.)		
	Detects wafers and small differences in height; enclosure rating: IEC 60529 IP50		E3X-NA□ (V)	7.2±1.8	25×25 (0.015-mm dia.)	E32-L25L	10 mm
			E3X-NA□F	7.2±1.8	25×25 (0.03-mm dia.)		
	Detects wafers and small differences in height; enclosure rating: IEC 60529 IP50 (Free-cut)		E3X-NA□ (V)	3.3	25×25 (0.015-mm dia.)	E32-L25	25 mm
			E3X-NA□F	3.3	25×25 (0.03-mm dia.)		
			E3X-NA□ (V)	3.3	25×25 (0.015-mm dia.)	E32-L25A	25 mm
			E3X-NA□F	3.3	25×25 (0.03-mm dia.)		
Fluid-level detection	Fluid contact type: unbendable section L 150 mm, 350 mm (two types)		E3X-NA□ (V)	---	---	E32-D82F1 E32-D82F2	40 mm
			E3X-NA□F	---	---		
	Tube-mounting type (Free-cut)		E3X-NA□ (V)	---	---	E32-L25T	10 mm
			E3X-NA□F	---	---		

*1 Sensing distance indicates values for white paper.

*2 For continuous operation, use the products within a temperature range of -40°C to 130°C.

*3 Teflon is a registered trademark of the Dupont Company and the Mitsui Dupont Chemical Company for their fluoride resin.

*4 Indicates the heat-resistant temperature at the fiber tip.

Note: The values of the minimum sensing target indicate those obtained at a distance where the smallest object can be sensed with the Reflective Fiber Unit.

ALL DIMENSIONS SHOWN ARE IN MILLIMETERS.

To convert millimeters into inches, multiply by 0.03937. To convert grams into ounces, multiply by 0.03527.

OMRON**OMRON ELECTRONICS LLC**

One East Commerce Drive
Schaumburg, IL 60173

1-800-55-OMRON**OMRON ON-LINE**

Global - <http://www.omron.com>
USA - <http://www.omron.com/oei>
Canada - <http://www.omron.com/oci>

OMRON CANADA, INC.

885 Milner Avenue
Scarborough, Ontario M1B 5V8

416-286-6465