

# Digital Fiber Sensors E3X-DA-S

## The Next-Generation Platform for a Wide Range of Sensing

- Power tuning function addresses saturation or insufficient light conditions.
- Dual digital display enables simultaneous monitoring of current and preset values.
- 4 element LED and Auto Power Control ensure stable, long term performance.
- Advanced functions include differential operation for minute detection, 2 independent outputs for area detection, remote input function, and counter function.
- Improved mobile console.
- Same ease-of-use as the E3X-DA-N amplifiers.
- Highest speed in the industry.



## Ordering Information

### ■ Amplifier Units

**Stock Note:** Shaded models are normally stocked.

#### Amplifier Units with Cables

Item	Appearance	Functions	Model		
			NPN output	PNP output	
Standard models		---	E3X-DA11-S	E3X-DA41-S	
Mark-detecting models		Green LED	---	E3X-DAG11-S	E3X-DAG41-S
		Blue LED	---	E3X-DAB11-S	E3X-DAB41-S
Advanced models		Two-output models	Area output, self-diagnosis, differential operation	E3X-DA11TW-S	E3X-DA41TW-S
		External-input models	Remote setting, counter, differential operation	E3X-DA11RM-S	E3X-DA41RM-S

#### Amplifier Units with Connectors

Item	Appearance	Functions	Model		
			NPN output	PNP output	
Standard models		---	E3X-DA6-S	E3X-DA8-S	
Mark-detecting models		Green LED	---	E3X-DAG6-S	E3X-DAG8-S
		Blue LED	---	E3X-DAB6-S	E3X-DAB8-S
Advanced models		Two-output models	Area output, self-diagnosis, differential operation	E3X-DA6TW-S	E3X-DA8TW-S
		External-input models	Remote setting, counter, differential operation	E3X-DA6RM-S	E3X-DA8RM-S

## ■ Amplifier Unit Connectors (Order Separately)

**Stock Note:** Shaded models are normally stocked.

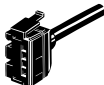
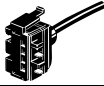
Item	Appearance	Cable length	No. of conductors	Model
Master Connector		2 m	3	E3X-CN11
			4	E3X-CN21
Slave Connector			1	E3X-CN12
			2	E3X-CN22

### Combining Amplifier Units and Connectors

Amplifier Units and Connectors are sold separately. Refer to the following tables when placing an order.

Amplifier Unit			+	Applicable Connector (Order Separately)	
Model	NPN output	PNP output		Master Connector	Slave Connector
Standard models	E3X-DA6-S	E3X-DA8-S		E3X-CN11 (3-wire)	E3X-CN12 (1-wire)
Mark-detecting models	E3X-DAG6-S	E3X-DAG8-S			
		E3X-DAB6-S	E3X-DAB8-S	E3X-CN21 (4-wire)	E3X-CN22 (2-wire)
Advanced models	E3X-DA6TW-S	E3X-DA8TW-S			
		E3X-DA6RM-S	E3X-DA8RM-S		

### Combining Multiple Wire-saving Amplifiers and Connector Cables

When combining wire-saving amplifiers, the amplifiers that are connected together must all have the same part number. Only one master connector is required. The master connector cable distributes power to all the “ganged” wire-saving amplifiers. The rest of the wire-saving amplifiers require slave connector cables; slave connector cables handle output signal transmission only.



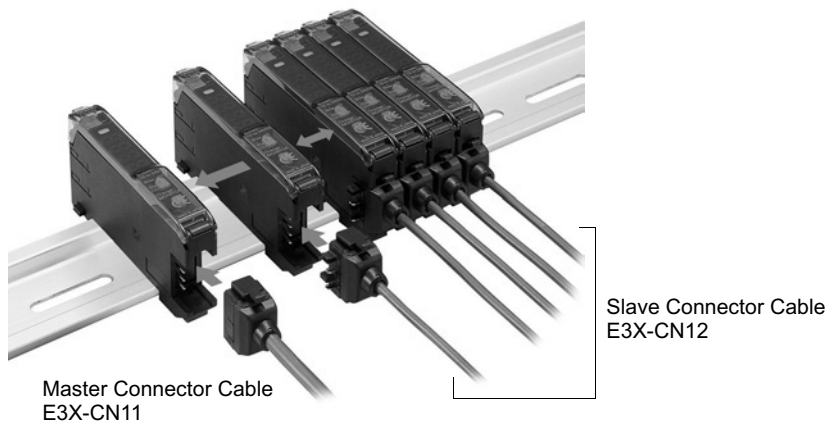

Example: Requirements for combining 5 E3X-DA6 amplifiers:

- 1 master connector cable
- 5 slave connector cables
- 6 E3X-DA6 amplifiers



## Mobile Console (Order Separately)

**Stock Note:** Shaded models are normally stocked.

Appearance	Model	Remarks
	E3X-MC11-S (model number of set)	Mobile Console with Head, Cable, and AC adapter provided as accessories
	E3X-MC11-C1-S	Mobile Console
	E3X-MC11-H1	Head
	E39-Z12-1	Cable (1.5 m)

**Note:** Use the E3X-MC11-S Mobile Console for the E3X-DA-S-series Amplifier Units. Other Mobile Consoles cannot be used.

## Accessories (Order Separately)

**Stock Note:** Shaded models are normally stocked.

### Mounting Bracket

Appearance	Model	Quantity
	E39-L143	1

### End Plate

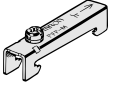
Appearance	Model	Quantity
	PFP-M	1

# Specifications

## ■ Ratings/Characteristics

### Amplifier Units

#### Amplifier Units with Cables

Item	Type		Standard models	Mark-detecting models		Advanced, two-output models	Advanced, external-input models
	Model	NPN output	E3X-DA11-S	E3X-DAG11-S	E3X-DAB11-S	E3X-DA11TW-S	E3X-DA11RM-S
		PNP output	E3X-DA41-S	E3X-DAG41-S	E3X-DAB41-S	E3X-DA41TW-S	E3X-DA41RM-S
Light source (wavelength)			Red LED (650 nm)	Green LED (525 nm)	Blue LED (470 nm)	Red LED (650 nm)	
Supply voltage			12 to 24 VDC ±10%, ripple (p-p) 10% max.				
Power consumption			960 mW max. (current consumption: 40 mA max. at power supply voltage of 24 VDC)			1,080 mW max. (current consumption: 45 mA max. at power supply voltage of 24 VDC)	
Control output			Load power supply voltage: 26.4 VDC; NPN/PNP open collector; load current: 50 mA max.; residual voltage: 1 V max.				
Circuit protection			Reverse polarity for power supply connection, output short-circuit				
Response time	High-speed mode	NPN	48 μs for operation and 50 μs for reset			80 μs for operation and reset respectively	48 μs for operation and 50 μs for reset*1
		PNP	53 μs for operation and 55 μs for reset				53 μs for operation and 55 μs for reset*1
	Standard mode		1 ms for operation and reset respectively				
	High-resolution mode		4 ms for operation and reset respectively				
Sensitivity setting			Teaching or manual method				
Functions	Power tuning		Light emission power and reception gain, digital control method				
	Differential detection		---			Switchable between single edge and double edge detection mode Single edge: Can be set to 250 μs, 500 μs, 1 ms, 10 ms, or 100 ms. Double edge: Can be set to 500 μs, 1 ms, 2 ms, 20 ms, or 200 ms.	
	Timer function		Select from OFF-delay, ON-delay, or one-shot timer. 1 ms to 5 s (1 to 20 ms set in 1-ms increments, 20 to 200 ms set in 10-ms increments, 200 ms to 1 s set in 100-ms increments, and 1 to 5 s set in 1 s-increments)				
	Automatic power control (APC)		High-speed control method for emission current				
	Zero-reset		Display can be reset to zero when required (negative values can be displayed).				
	Initial reset		Settings can be returned to defaults as required.				
	Mutual interference prevention		Possible for up to 10 Units*2, *3				
	Counter		---			Switchable between up counter and down counter. Set count: 0 to 9,999,999	
I/O settings		---			Output setting (Select from channel 2 output, area output, or self-diagnosis.)	External input setting (Select from teaching, power tuning, zero reset, light OFF, or counter reset.)	
Display			Operation indicator (orange), Power Tuning indicator (orange)			Operation indicator for channel 1 (orange), Operation indicator for channel 2 (orange)	Operation indicator (orange), Power Tuning indicator (orange)
Digital display			Select from the following: Incident level + threshold, incident light peak level + no incident light bottom level, minimum incident light peak level + maximum no incident light bottom level, long bar display, incident level + peak hold, incident level + channel			Select from same displays as given at the left or a counter display.	
Display orientation			Normal/reversed program selectable.				

Item	Model	Type	Standard models	Mark-detecting models		Advanced, two-output models	Advanced, external-input models
		NPN output	E3X-DA11-S	E3X-DAG11-S	E3X-DAB11-S	E3X-DA11TW-S	E3X-DA11RM-S
		PNP output	E3X-DA41-S	E3X-DAG41-S	E3X-DAB41-S	E3X-DA41TW-S	E3X-DA41RM-S
Ambient illumination (receiver side)			Incandescent lamp:10,000 lux max. Sunlight:20,000 lux max.				
Ambient temperature			Operating: Groups of 1 to 2 Amplifiers: -25°C to 55°C Groups of 3 to 10 Amplifiers: -25°C to 50°C Groups of 11 to 16 Amplifiers: -25°C to 45°C (with no icing or condensation) Storage: -30°C to 70°C (with no icing or condensation)				
Ambient humidity			Operating and storage: 35% to 85% (with no condensation)				
Insulation resistance			20 MΩ min. (at 500 VDC)				
Dielectric strength			1,000 VAC at 50/60 Hz for 1 minute				
Vibration resistance (destruction)			10 to 55 Hz with a 1.5-mm double amplitude for 2 hrs each in X, Y and Z directions				
Shock resistance (destruction)			500 m/s <sup>2</sup> , for 3 times each in X, Y and Z directions				
Enclosure rating			IEC 60529 IP50 (with Protective Cover attached)				
Connection method			Prewired cable				
Weight (packed state)			Approx. 100 g				
Materials	Case		Polybutylene terephthalate (PBT)				
	Cover		Polycarbonate (PC)				
Accessories			Instruction sheet				

**Note:** \*1. When counter is enabled: 80 μs for operation and reset respectively.

\*2. Communications are disabled if the detection mode is selected during high-speed mode; the communications functions for mutual interference prevention and the Mobile Console will not function.

\*3. Mutual interference prevention can be used for up to 6 Units if power tuning is enabled.

## Amplifier Units with Connectors

(Specifications different to those for Amplifier Units with cables)

Item	Model	Type	Standard models	Mark-detecting models		Advanced, two-output models	Advanced, external-input models
		NPN output	E3X-DA6-S	E3X-DAG6-S	E3X-DAB6-S	E3X-DA6TW-S	E3X-DA6RM-S
		PNP output	E3X-DA8-S	E3X-DAG8-S	E3X-DAB8-S	E3X-DA8TW-S	E3X-DA8RM-S
Connection method			Standard connector				
Weight (packed state)			Approx. 55 g				

## Amplifier Unit Connectors

Item	E3X-CN11/21/22		E3X-CN12
Rated current	2.5 A		
Rated voltage	50 V		
Contact resistance	20 mΩ max. (20 mVDC max., 100 mA max.) (The figure is for connection to the Amplifier Unit and the adjacent Connector. It does not include the conductor resistance of the cable.)		
No. of insertions (destruction)	50 times (The figure for the number of insertions is for connection to the Amplifier Unit and the adjacent Connector.)		
Materials	Housing	Polybutylene terephthalate (PBT)	
	Contacts	Phosphor bronze/gold-plated nickel	
Weight (packed state)	Approx. 55 g		Approx. 25 g

## Mobile Console

Item	E3X-MC11-S
Supply voltage	Charged with AC adapter
Connection method	Connected via adapter
Weight (packed state)	Approx. 580 g (Console only: 120 g)

**Note:** Refer to *Operation Manual* provided with the Mobile Console for details.









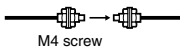
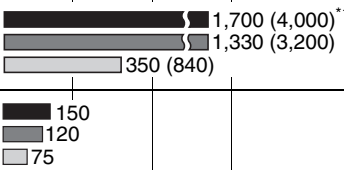

# Ordering Information: Fiber Units

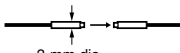
## Through-beam Fiber Units

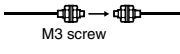
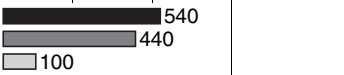
- Note:**
1.  Indicates models that allow free cutting. Models without this mark do not allow free cutting.
  2. The size of standard sensing object is the same as the fiber core diameter (lens diameter for models with lens).
  3. The values for the minimum sensing object are representative values that indicate values obtained in standard mode with the sensing distance and sensitivity set to optimum values.

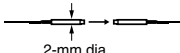
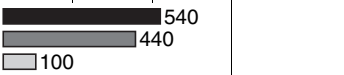
## Long-distance Fiber Units

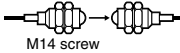
 : High-resolution mode  : Standard mode  : Super-high-speed mode

Features	Appearance	Applicable Amplifier Unit	Sensing distance (mm) (Parentheses: With E39-F1 Lens Unit)	Standard object (min. object) (Parentheses: Opaque object)	Model	Permissible bending radius
M4 	 M4 screw	E3X-DA□-S  E3X-DAG□-S E3X-DAB□-S	 1,700 (4,000) <sup>*1</sup> 1,330 (3,200) 350 (840)  150 120 75	1.4-mm dia. (0.01-mm dia.)	E32-T11L	25 mm
3-mm dia. 	 3-mm dia.	E3X-DA□-S	 1,700 1,330 350		E32-T12L	
M3 	 M3 screw	E3X-DA□-S	 540 440 100	0.9-mm dia. (0.005-mm dia.)	E32-T21L	10 mm
2-mm dia.; small diameter 	 2-mm dia.	E3X-DA□-S	 540 440 100		E32-T22L	
M14 with lens; ideal for explosion-proof applications 	 M14 screw	E3X-DA□-S	 20,000 <sup>*2</sup> 20,000 <sup>*2</sup> 4,000 <sup>*2</sup>	10-mm dia.	E32-T17L	25 mm

- Note:**
1. The optical fiber is 2 m long on each side, so the sensing distance is 4,000 mm.
  2. The optical fiber for the E32-T17L is 10 m long on each side, so the value is 20,000 mm

### A Wide Range of Multicore Fibers for Easy Installation without Loss of Light Intensity

Multicore fiber models are indicated by an "R" at the end of the model number.  
Multicore fiber contains multiple cores. These cores are all surrounded by cladding, giving a minimum bending radius of 1 mm.

The fiber can be bent at right angles without affecting the light intensity. Do not use this fiber in applications that have repetitive flexing.

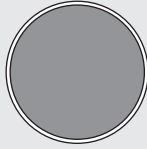



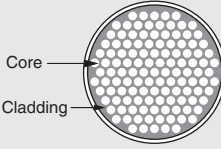





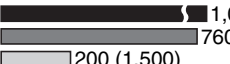
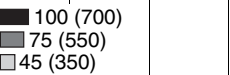

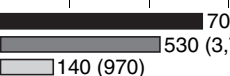

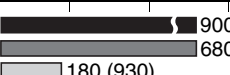
**Conventional Fiber**  
Conventional fiber uses just one core and one cladding section. Bending the fiber may break it or reduce the light intensity.

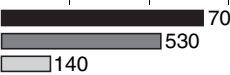

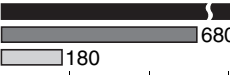

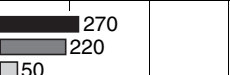

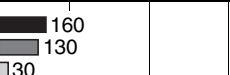
**Multicore Fiber**  
Multicore fiber contains multiple independent cores all surrounded by cladding. The fiber can be bent without breaking or reducing the light intensity.

## General-purpose Fiber Units



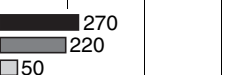

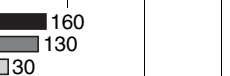
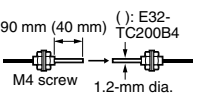
Features	Appearance	Applicable Amplifier Unit	Sensing distance (mm) (Parentheses: With E39-F1 Lens Unit)	Standard object (min. object) (Parentheses: Opaque object)	Model	Permissible bending radius
M4		E3X-DA□-S	 1,000 (4,000)* 760 (4,000)* 200 (1,500)	1.0-mm dia. (0.005-mm dia.)	E32-TC200	25 mm
		E3X-DAG□-S E3X-DAB□-S	 100 (700) 75 (550) 45 (350)			
M4 Multicore		E3X-DA□-S	 700 (4,000)* 530 (3,700) 140 (970)		E32-T11R	1 mm
M4 Fiber sheath material : floresin		E3X-DA□-S	 900 (4,000)* 680 (3,600) 180 (930)		E32-T11U <i>NEW</i>	4 mm
3-mm dia. Multicore		E3X-DA□-S	 700 530 140		E32-T12R	1 mm
M3 Possible to mount the E39-F5 Reflective Side-view Conversion Attachment		E3X-DA□-S	 900 680 180		E32-TC200A	25 mm
M3; for detecting minute objects		E3X-DA□-S	 270 220 50	0.5-mm dia. (0.005-mm dia.)	E32-TC200E	10 mm
		E3X-DAG□-S E3X-DAB□-S	 25 20 12			
M3 Multicore		E3X-DA□-S	 160 130 30		E32-T21R	1 mm

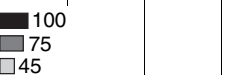
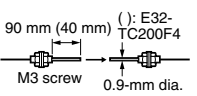
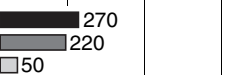
Note: \*The optical fiber is 2 m long on each side, so the sensing distance is 4,000 mm.

## Fiber Units with Thin Heads

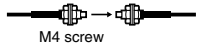

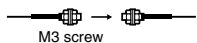

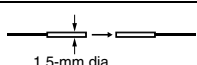
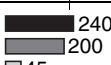



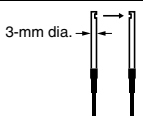
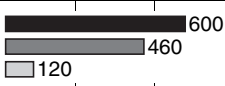

Features	Appearance	Applicable Amplifier Unit	Sensing distance (mm) (Parentheses: With E39-F1 Lens Unit)	Standard object (min. object) (Parentheses: Opaque object)	Model	Permissible bending radius
2-mm dia.; for detecting minute objects		E3X-DA□-S	 270 220 50	0.5-mm dia. (0.005-mm dia.)	E32-T22	10 mm
2-mm dia.; for detecting minute objects; multicore		E3X-DA□-S	 160 130 30		E32-T22R	1 mm
1.2-mm dia.; with sleeve		E3X-DA□-S	 1,000 760 200	1.0-mm dia. (0.005-mm dia.)	E32-TC200B E32-TC200B4	25 mm
		E3X-DAG□-S E3X-DAB□-S	 100 75 45			
0.9-mm dia.; with sleeve		E3X-DA□-S	 270 220 50	0.5-mm dia. (0.005-mm dia.)	E32-TC200F E32-TC200F4	10 mm

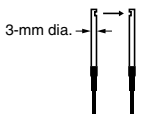
## Flexible Fiber Units (Resists Breaking) (R4)

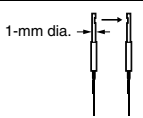
Features	Appearance	Applicable Amplifier Unit	Sensing distance (mm) (Parentheses: With E39-F1 Lens Unit)	Standard object (min. object) (Parentheses: Opaque object)	Model	Permissible bending radius
Ideal for mounting on moving sections (R4)	 M4 screw	E3X-DA□-S	 900 (4,000)* 680 (3,600) 180 (930)	1.0-mm dia. (0.005-mm dia.)	E32-T11	4 mm
	 M3 screw	E3X-DA□-S	 240 200 45		E32-T21	
	 1.5-mm dia.	E3X-DA□-S	 240 200 45		E32-T22B	

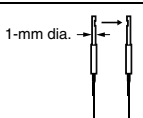
Note: \*The optical fiber is 2 m long on each side, so the sensing distance is 4,000 mm.

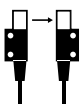
## Side-view Fiber Units

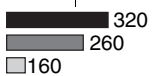
Features	Appearance	Applicable Amplifier Unit	Sensing distance (mm) (Parentheses: With E39-F1 Lens Unit)	Standard object (min. object) (Parentheses: Opaque object)	Model	Permissible bending radius
Long distance; space-saving	 3-mm dia.	E3X-DA□-S	 600 460 120	1.0-mm dia. (0.005-mm dia.)	E32-T14L	25 mm
		E3X-DAG□-S E3X-DAB□-S	 50 40 25			
Space-saving; multicore	 3-mm dia.	E3X-DA□-S	 270 210 50		E32-T14LR	1 mm
Suitable for detecting minute objects; small diameter	 1-mm dia.	E3X-DA□-S	 160 130 30	0.5-mm dia. (0.005-mm dia.)	E32-T24	10 mm
Suitable for detecting minute objects; small diameter; multicore	 1-mm dia.	E3X-DA□-S	 60 50 10		E32-T24R	1 mm
Screw-mounting type; long distance		E3X-DA□-S	 4,500 3,400 900	4-mm dia. (0.1-mm dia.)	E32-T14	25 mm
		E3X-DAG□-S E3X-DAB□-S	 320 260 160			



## Chemical-resistant Fiber Units

Features	Appearance	Applicable Amplifier Unit	Sensing distance (mm) (Parentheses: With E39-F1 Lens Unit)	Standard object (min. object) (Parentheses: Opaque object)	Model	Permissible bending radius
Teflon-covered*; round head that resists water drops	7.2-mm dia.	E3X-DA□-S	2,500 2,000 520	4-mm dia. (0.1-mm dia.)	E32-T11F <b>NEW</b>	4 mm
Teflon-covered*; withstands chemicals and harsh environments (operating ambient temperature: -30°C to 70°C)	5-mm dia.	E3X-DA□-S	4,000 3,000 800	4-mm dia. (0.1-mm dia.)	E32-T12F	40 mm
Teflon-covered*; withstands chemicals and harsh environments; side-view (operating ambient temperature: -30°C to 70°C)	5-mm dia.	E3X-DA□-S	500 400 100	3-mm dia. (0.1-mm dia.)	E32-T14F	
Teflon*; withstands chemicals and harsh environments (operating ambient temperature: -40°C to 200°C)	6-mm dia.	E3X-DA□-S	920 700 190	1.0-mm dia. (0.005-mm dia.)	E32-T81F-S <b>NEW</b>	10 mm

**Note:** Teflon is a registered trademark of the Dupont Company and the Mitsui Dupont Chemical Company for their fluoride resin.

## Heat-resistant Fiber Units

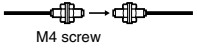
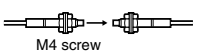
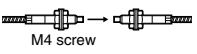
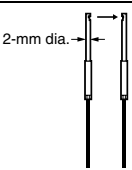
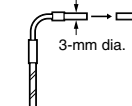
Features	Appearance	Applicable Amplifier Unit	Sensing distance (mm) (Parentheses: With E39-F1 Lens Unit)	Standard object (min. object) (Parentheses: Opaque object)	Model	Permissible bending radius
Resists 150°C <sup>*1</sup> ; fiber sheath material: fluoro-resin (operating ambient temperature: -40°C to 150°C)	 M4 screw	E3X-DA□-S	1,000 760 200	1.5-mm dia. (0.1-mm dia.)	E32-T51	35 mm
Resists 200°C; flexible (R10); fiber sheath material: Teflon <sup>*2</sup> (operating ambient temperature: -40°C to 200°C)	 M4 screw	E3X-DA□-S	360 (2,650) 280 (2,100) 70 (520)	1.0-mm dia. (0.005-mm dia.)	E32-T81R-S <i>NEW</i>	10 mm
Resists 350°C <sup>*3</sup> , with spiral tube; high mechanical strength; fiber sheath material: stainless steel (operating ambient temperature: -60°C to 350°C)	 M4 screw	E3X-DA□-S	600 (4,000) <sup>*4</sup> 450 (3,400) 120 (900)		E32-T61-S <i>NEW</i>	25 mm
Side-view; resists 150°C <sup>*1</sup> ; suitable for detecting minute objects; fiber sheath material: fluoro-resin (operating ambient temperature: -40°C to 150°C)	 2-mm dia.	E3X-DA□-S	300 230 60		E32-T54	35 mm
Resists 200°C <sup>*3</sup> ; L-shaped; fiber sheath material: stainless steel	 3-mm dia.	E3X-DA□-S	1,750 1,300 350	1.7-mm dia. (0.1-mm dia.)	E32-T84S-S <i>NEW</i>	25 mm

**Note:** \*1. For continuous operation, use the products within a temperature range of -40°C to 130°C.

\*2. Teflon is a registered trademark of the Dupont Company and the Mitsui Dupont Chemical Company for their fluoride resin.

\*3. Indicates the heat-resistant temperature at the fiber tip.

\*4. The optical fiber is 2 m long on each side, so the sensing distance is 4,000 mm.







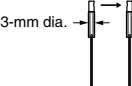
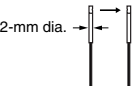
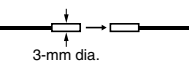
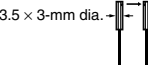

## Fiber Unit with Slot Sensor

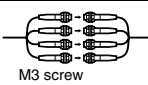
Features	Appearance	Applicable Amplifier Unit	Sensing distance (mm) (Parentheses: With E39-F1 Lens Unit)	Standard object (min. object) (Parentheses: Opaque object)	Model	Permissible bending radius
Suitable for film sheet detection; no optical axis adjustment required; easy to mount		E3X-DA□-S E3X-DAG□-S E3X-DAB□-S	110 110 110	4-mm dia. (0.1-mm dia.)	E32-G14	25 mm

## Fiber Units with a Narrow Vision Field

Features	Appearance	Applicable Amplifier Unit	Sensing distance (mm) (Parentheses: With E39-F1 Lens Unit)	Standard object (min. object) (Parentheses: Opaque object)	Model	Permissible bending radius
Super-narrow vision field; side-view; opening angle: 1.5°; simple adjustment	 3-mm dia.	E3X-DA□-S	1,150 890 250	2-mm dia. (0.1-mm dia.)	E32-A03	1 mm
Super-narrow vision field; small; side-view; opening angle: 3°; simple adjustment	 2-mm dia.	E3X-DA□-S	460 340 100	1.2-mm dia. (0.1-mm dia.)	E32-A04	10 mm
Suitable for detecting wafers	 3-mm dia.	E3X-DA□-S	2,500 1,900 500	1.7-mm dia. (0.1-mm dia.)	E32-T22S	25 mm
Side-view; suitable for detecting wafers	 3.5 x 3-mm dia.	E3X-DA□-S	1,750 1,300 350	2-mm dia. (0.1-mm dia.)	E32-T24S	10 mm

## Area-sensing Fiber Units

Features	Appearance	Applicable Amplifier Unit	Sensing distance (mm) (Parentheses: With E39-F1 Lens Unit)	Standard object (min. object) (Parentheses: Opaque object)	Model	Permissible bending radius
Multi-point detection (4-head)	 M3 screw	E3X-DA□-S	750 610 140	2-mm dia. (0.1-mm dia.)	E32-M21	25 mm
Detects in a 30-mm area	 30 mm	E3X-DA□-S	2,300 1,800 450	(0.3-mm dia.)*1	E32-T16W	10 mm
	 30 mm	E3X-DA□-S	1,700 1,300 340		E32-T16WR (multicore)	1 mm
Side-view; suitable for applications with limited spatial depth	 11 mm	E3X-DA□-S	1,300 1,000 260	(0.2-mm dia.)*1	E32-T16J	10 mm
	 11 mm	E3X-DA□-S	980 750 190		E32-T16JR (multicore)	1 mm
Suitable for detecting over a 10-mm area; long distance	 10 mm	E3X-DA□-S	3,700 2,800 740	(0.6-mm dia.)*2	E32-T16	25 mm
Stable for detecting minute objects in a wide area	 11 mm	E3X-DA□-S	1,500 1,100 300	(0.2-mm dia.)*1	E32-T16P	10 mm
	 11 mm	E3X-DA□-S	1,100 840 220		E32-T16PR (multicore)	1 mm









**Note:** \*1. These figures are for a sensing distance of 300 mm. (Figures for the diameter of sensing objects are in the still state.)

\*2. These figures are ones for which detection is possible in each sensing area at a digital incident level of 1,000. (Figures for the diameter of sensing objects are in the still state.)

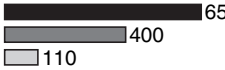
## ■ Diffuse Fiber Units

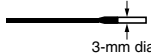
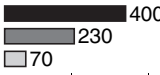

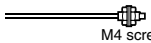
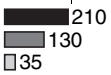
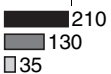

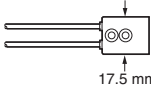
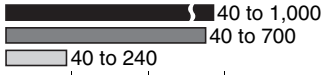



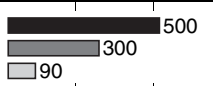

- Note:** 1.  Indicates models that allow free cutting. Models without this mark do not allow free cutting.  
 2. The values for the minimum sensing object are representative values that indicate values obtained in standard mode with the sensing distance and sensitivity set to optimum values.  
 3. When set to the maximum sensitivity setting, internal light reflection may cause the sensor to detect incident light. In such case, adjust the threshold manually or automatically (teaching).

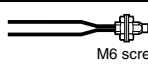
### Long-distance Fiber Units

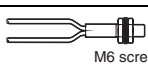
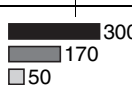
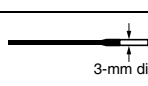
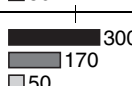
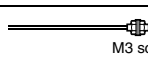
Features	Appearance	Applicable Amplifier Unit	Sensing distance (mm)*	Standard object (min. object: Gold wire)	Model	Permissible bending radius
M6 	 M6 screw	E3X-DA□-S	 650 400 110	500×500 (0.005-mm dia.)	E32-D11L	25 mm
		E3X-DAG□-S E3X-DAB□-S	 44 35 22	100×100 (0.1-mm dia.)		
3-mm dia.; small diameter 	 3-mm dia.	E3X-DA□-S	 400 230 70	300×300 (0.005-mm dia.)	E32-D12	
M4 	 M4 screw	E3X-DA□-S	 210 130 35	200×200 (0.005-mm dia.)	E32-D21L	10 mm
		E3X-DA□-S	 210 130 35			
Square head, long distance 	 17.5 mm	E3X-DA□-S	 40 to 1,000 40 to 700 40 to 240	300×300	E32-D16 <i>NEW</i>	4 mm

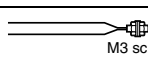

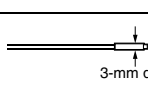



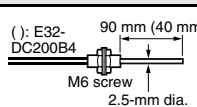
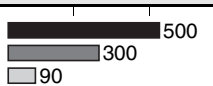

**Note:** \*Values were obtained using a white paper (standard object).

### General-purpose Fiber Units

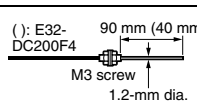
Features	Appearance	Applicable Amplifier Unit	Sensing distance (mm)*	Standard object (min. object: Gold wire)	Model	Permissible bending radius
M6	 M6 Screw	E3X-DA□-S		400×400 (0.005-mm dia.)	E32-DC200	25 mm
		E3X-DAG□-S E3X-DAB□-S		100×100 (0.1-mm dia.)		
M6 ; multicore	 M6 screw	E3X-DA□-S		300×300 (0.005-mm dia.)	E32-D11R	1 mm
M6 Fiber sheath material: fluororesin	 M6 screw	E3X-DA□-S			E32-D11U <i>NEW</i>	4 mm
3-mm dia.; multicore	 3-mm dia.	E3X-DA□-S			E32-D12R	1 mm
M3; small diameter	 M3 screw	E3X-DA□-S		100×100 (0.005-mm dia.)	E32-DC200E	10 mm
		E3X-DAG□-S E3X-DAB□-S		25×25 (0.2-mm dia.)		
M3; small diameter; multicore	 M3 screw	E3X-DA□-S		50×50 (0.005-mm dia.)	E32-D21R	1 mm
3-mm dia.; small diameter; multicore	 3-mm dia.	E3X-DA□-S			E32-D22R	

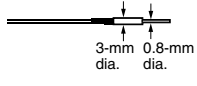

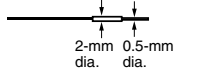

Note: \*Values were obtained using a white paper (standard object).

### Fiber Units with Thin Heads

Features	Appearance	Applicable Amplifier Unit	Sensing distance (mm)*	Standard object (min. object: Gold wire)	Model	Permissible bending radius
2.5-mm dia.; with sleeve	 ( ): E32-DC200B4 90 mm (40 mm) M6 screw 2.5-mm dia.	E3X-DA□-S		400×400 (0.005-mm dia.)	E32-DC200B E32-DC200B4	25 mm
		E3X-DAG□-S E3X-DAB□-S		100×100 (0.1-mm dia.)		
1.2-mm dia.; with sleeve	 ( ): E32-DC200F4 90 mm (40 mm) M3 screw 1.2-mm dia.	E3X-DA□-S		100×100 (0.005-mm dia.)	E32-DC200F E32-DC200F4	10 mm
0.8-mm dia.; for detecting minute objects	 3-mm dia. 0.8-mm dia.	E3X-DA□-S		25×25 (0.005-mm dia.)	E32-D33	4 mm
0.5-mm dia.; for detecting very minute objects	 2-mm dia. 0.5-mm dia.	E3X-DA□-S			E32-D331	







Note: \*Values were obtained using a white paper (standard object).

## Flexible Fiber Units (Resists Breaking) (R4)

Features	Appearance	Applicable Amplifier Unit	Sensing distance (mm)*	Standard object (min. object: Gold wire)	Model	Permissible bending radius
Ideal for mounting on moving sections (R4)	 M6 screw	E3X-DA□-S	300 170 50	300×300 (0.005-mm dia.)	E32-D11	4 mm
	 M3 screw	E3X-DA□-S	50 30 8	50×50 (0.005-mm dia.)	E32-D21	
	 M4 screw	E3X-DA□-S	110 70 20	100×100 (0.005-mm dia.)	E32-D21B	
	 1.5-mm dia.	E3X-DA□-S	50 30 8	50×50 (0.005-mm dia.)	E32-D22B	





Note: \*Values were obtained using a white paper (standard object).

## Coaxial Fiber Units





Features	Appearance	Applicable Amplifier Unit	Sensing distance (mm)*	Standard object (min. object: Gold wire)	Model	Permissible bending radius
M6 coaxial; high-precision positioning	 M6 screw	E3X-DA□-S	500 300 90	500×500 (0.005-mm dia.)	E32-CC200	25 mm
		E3X-DAG□-S E3X-DAB□-S	32 25 16	100×100 (0.1-mm dia.)		
3-mm dia.; small diameter; coaxial; high-precision positioning	 3-mm dia.	E3X-DA□-S	250 150 45	300×300 (0.005-mm dia.)	E32-D32L	
M3 coaxial; high-precision positioning	 M3 screw	E3X-DA□-S	120 75 22	See "Spot diameter" • 0.5-mm dia. • 4.0-mm dia. max.	100×100 (0.005-mm dia.)	E32-C31
M3 coaxial; high-precision positioning	 M3 screw	E3X-DA□-S	50 35 8	See "Spot diameter" • 0.1-mm dia. • 0.2-mm dia. • 4.0-mm dia. max.	50×50 (0.005-mm dia.)	E32-C41
2-mm dia. coaxial; high-precision positioning	 2-mm dia.	E3X-DA□-S	50 35 8	See "Spot diameter" • Adjustable in the range 0.1 to 0.6-mm dia.		E32-C42
2-mm dia. coaxial; high-precision positioning	 2-mm dia.	E3X-DA□-S	120 75 22	See "Spot diameter" • Adjustable in the range 0.5 to 1-mm dia.	100×100 (0.005-mm dia.)	E32-D32

Note: \*Values were obtained using a white paper (standard object).

### Spot Diameter (Order Lens separately)

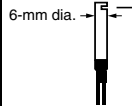

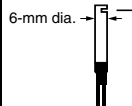
Lens	Appearance	Focusing lens type	Spot diameter values	
E39-F3A		Variable	E32-C42 Spot: 0.1-0.6 mm dia.	E32-D32 Spot: 0.5-1.0 mm dia.
E39-F3A-5		Fixed	E32-C31 Spot: 0.5 mm dia. Focal length: 7 mm	E32-C41 Spot: 0.1 mm dia. Focal length: 7 mm
E39-F3B			E32-C31 Spot: 0.5 mm dia. Focal length: 17 mm	E32-C41 Spot: 0.2 mm dia. Focal length: 17 mm
E39-F3C			E32-C31 Spot: 4.0 mm dia. Focal length: 20 mm	E32-C41 Spot: 4.0 mm dia. Focal length: 20 mm

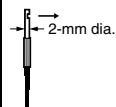
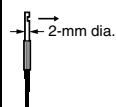
### Side-view Fiber Units

Features	Appearance	Applicable Amplifier Unit	Sensing distance (mm)*			Standard object (min. object: Gold wire)	Model	Permissible bending radius
6-mm dia.; long distance 		E3X-DA□-S	■ 200	■ 110	□ 36	200×200 (0.005-mm dia.)	E32-D14L	25 mm
6-mm dia.; multicore 		E3X-DA□-S	■ 80	■ 45	□ 14	100×100 (0.005-mm dia.)	E32-D14LR	1 mm
2-mm dia.; small diameter; space-saving 		E3X-DA□-S	■ 50	■ 30	□ 8	50×50 (0.005-mm dia.)	E32-D24	10 mm
		E3X-DA□-S	■ 26	■ 15	□ 4		E32-D24R (multicore)	1 mm

Note: \*Values were obtained using a white paper (standard object).







### Chemical-resistant Fiber Units

Features	Appearance	Applicable Amplifier Unit	Sensing distance (mm) <sup>1)</sup>			Standard object (min. object: Gold wire)	Model	Permissible bending radius
Teflon-covered <sup>2)</sup> ; withstands chemicals and harsh environments (operating ambient temperature: -30°C to 70°C) 		E3X-DA□-S	■ 160	■ 95	□ 30	200×200 (0.005-mm dia.)	E32-D12F	40 mm

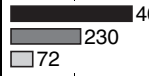
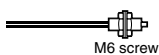
Note: 1. \*Values were obtained using a white paper (standard object).

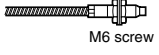
2. Teflon is a registered trademark of the Dupont Company and the Mitsui Dupont Chemical Company for their fluoride resin.

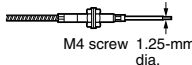
## Heat-resistant Fiber Units

Features	Appearance	Applicable Amplifier Unit	Sensing distance (mm) <sup>*1</sup>	Standard object (min. object: Gold wire)	Model	Permissible bending radius
Resists 150°C <sup>2</sup> ; fiber sheath material: fluororesin (operating ambient temperature: -40°C to 150°C)		E3X-DA□-S	 400 230 72	200×200 (0.005-mm dia.)	E32-D51	35 mm
Resists 200°C <sup>3</sup> ; fiber sheath material: fluororesin (operating ambient temperature: -40°C to 200°C)		E3X-DA□-S	 150 90 27		E32-D81R-S <i>NEW</i>	10 mm
Resists 350°C <sup>3</sup> ; fiber sheath material: stainless steel (operating ambient temperature: -60°C to 350°C)		E3X-DA□-S	 150 90 27		E32-D61-S <i>NEW</i>	25 mm
Resists 400°C <sup>3</sup> ; fiber sheath material: stainless steel (operating ambient temperature: -40°C to 400°C)		E3X-DA□-S	 100 60 18	100×100 (0.005-mm dia.)	E32-D73-S <i>NEW</i>	

**Note:** \*1. Values were obtained using a white paper (standard object).

\*2. For continuous operation, use the products within a temperature range of -40°C to 130°C.



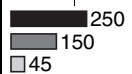

\*3. Indicates the heat-resistant temperature at the fiber tip.

## Area-sensing Fiber Units

Features	Appearance	Applicable Amplifier Unit	Sensing distance (mm)*	Standard object (min. object: Gold wire)	Model	Permissible bending radius
Side-view; detection over wide areas		E3X-DA□-S	 250 150 45	300×300 (0.005-mm dia.)	E32-D36P1	25 mm

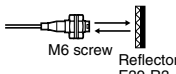
**Note:** \*Values were obtained using a white paper (standard object).

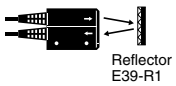







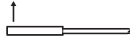

## Retroreflective Fiber Units

Features	Appearance	Applicable Amplifier Unit	Sensing distance (mm)*	Standard object (min. object: Gold wire)	Model	Permissible bending radius
Transparent object detection; Polarized		E3X-DA□-S	 10 to 250 10 to 250 10 to 250	35-mm dia. (0.1-mm dia.)	E32-R21 + E39-R3 (Attachment)	10 mm
Transparent object detection (operating ambient temperature: -25°C to 55°C); degree of protection: IEC60529 IP66; Polarized		E3X-DA□-S	 150 to 1,500 150 to 1,500 150 to 1,500	35-mm dia. (0.2-mm dia.)	E32-R16 + E39-R1 (Attachment)	25 mm

**Note:** \*Values were obtained using a white paper (standard object).

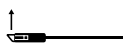





## Convergent Fiber Units

Features	Appearance	Applicable Amplifier Unit	Sensing distance (mm)*			Standard object (min. object: Gold wire)	Model	Permissible bending radius
Suitable for positioning liquid crystal glass 		E3X-DA□-S	10 to 15 10 to 15 10 to 15			100×100 Soda glass with reflection factor of 7%	E32-L16 <b>NEW</b>	25 mm
Suitable for positioning liquid crystal glass 		E3X-DA□-S	14 to 12 14 to 12 14 to 12				E32-L56E1 E32-L56E2	35 mm
Suitable for positioning liquid crystal glass (Resists 300°C)		E3X-DA□-S	15 to 18 15 to 18 15 to 18				E32-L66 <b>NEW</b>	25 mm
Liquid crystal glass, mounting detection, small 		E3X-DA□-S	10 to 4 10 to 4 10 to 4			25×25 (0.005-mm dia.)	E32-L24S <b>NEW</b>	10 mm
Detects wafers and small differences in height; (operating ambient temperature: -40°C to 105°C); degree of protection: IEC60529 IP50 		E3X-DA□-S	14±2 14±2 14±2				E32-L24L	10 mm
		E3X-DA□-S	17.2±1.8 17.2±1.8 17.2±1.8				E32-L25L	
Detects wafers and small differences in height; degree of protection: IEC60529 IP50 		E3X-DA□-S	13.3 13.3 13.3				E32-L25	25 mm
		E3X-DA□-S	13.3 13.3 13.3				E32-L25A	

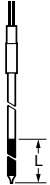
**Note:** Values were obtained using a white paper (standard object).

### Fluid-level Detection Fiber Units

Features	Appearance	Applicable Amplifier Unit	Sensing distance (mm)	Standard object (min. object: Gold wire)	Model	Permissible bending radius
Fluid contact type: unbendable section L 150 mm, 350 mm (two types); (operating ambient temperature: -40°C to 200°C)		E3X-DA□-S	---	Pure water at 25°C	E32-D82F1 E32-D82F2	40 mm
Tube-mounting type; Light ON when fluid is present; minimal influence from bubbles and water drops		E3X-DA□-S	Applicable tube: Transparent tube Tube diameter: 3.2, 6.4, or 9.5 mm (Tube must be FEP or material with equivalent transparency; recommended wall thickness: 1 mm)		E32-A01	4 mm
Tube-mounting type; light ON when fluid is present; minimal influence from bubbles and water drops		E3X-DA□-S	Applicable tube: Transparent tube Tube diameter: 6 to 13 mm (Tube must be FEP or material with equivalent transparency; recommended wall thickness: 1 mm)		E32-A02	
Tube-mounting type; dense mounting to detect level differences of 4 mm		E3X-DA□-S	Applicable tube: Transparent tube Tube diameter: 8 to 10 mm (Tube must be FEP or material with equivalent transparency; recommended wall thickness: 1 mm)		E32-L25T	10 mm
Tube-mounting type; unlimited tube diameter; minimal influence from bubbles and water drops		E3X-DA□-S	Applicable tube: Transparent tube Tube diameter: No restriction (Tube must be FEP or material with equivalent transparency)		E32-D36F	4 mm

# Output Circuits

## NPN Output

Model	Mode selector	Timing chart	State of output transistor	Output circuit
E3X-DA11-S E3X-DA6-S E3X-DAG11-S E3X-DAG6-S E3X-DAB11-S E3X-DAB6-S	LIGHT ON (L/ON)	Incident light No incident light Operation indicator (orange) ON OFF Output transistor ON OFF Load (relay) Operate Release (Between brown and black)	Light ON	
	DARK ON (D/ON)	Incident light No incident light Operation indicator (orange) ON OFF Output transistor ON OFF Load (relay) Operate Release (Between brown and black)	Dark ON	
E3X-DA11TW-S E3X-DA6TW-S	LIGHT ON (L/ON)	CH1/CH2 Incident light No incident light Operation indicator (orange) ON OFF Output transistor ON OFF Load (relay) Operate Release (Between brown and black)	Light ON	
	DARK ON (D/ON)	CH1/CH2 Incident light No incident light Operation indicator (orange) ON OFF Output transistor ON OFF Load (relay) Operate Release (Between brown and black)	Dark ON	
E3X-DA11RM-S E3X-DA6RM-S	LIGHT ON (L/ON)	Incident light No incident light Operation indicator (orange) ON OFF Output transistor ON OFF Load (relay) Operate Release (Between brown and black)	Light ON	
	DARK ON (D/ON)	Incident light No incident light Operation indicator (orange) ON OFF Output transistor ON OFF Load (relay) Operate Release (Between brown and black)	Dark ON	

**Note: 1.** When area setting is used with the E3X-DA□TW-S the ON/OFF regions are as follows:  
 LIGHT ON: ON when the incident level is between the thresholds for channels 1 and 2.  
 DARK ON: OFF when the incident level is between the thresholds for channels 1 and 2.

**2. Time Charts for Timer Settings (T: Set Time)**

ON delay	OFF delay	One-shot

# PNP Output

Model	Mode selector	Timing chart	State of output transistor	Output circuit
E3X-DA41-S E3X-DA8-S E3X-DAG41-S E3X-DAG8-S E3X-DAB41-S E3X-DAB8-S	LIGHT ON (L/ON)	Incident light	Light ON	
	DARK ON (D/ON)	Incident light	Dark ON	
E3X-DA41TW-S E3X-DA8TW-S	LIGHT ON (L/ON)	CH1/ Incident light	Light ON	
	DARK ON (D/ON)	CH1/ Incident light	Dark ON	
E3X-DA41RM-S E3X-DA8RM-S	LIGHT ON (L/ON)	Incident light	Light ON	
	DARK ON (D/ON)	Incident light	Dark ON	

**Note:** 1. When area setting is used with the E3X-DA□TW-S the ON/OFF regions are as follows:  
 LIGHT ON:ON when the incident level is between the thresholds for channels 1 and 2.  
 DARK ON:OFF when the incident level is between the thresholds for channels 1 and 2.  
 2. Time Charts for Timer Settings (T: Set Time)

ON delay	OFF delay	One-shot
Incident light	Incident light	Incident light

# Nomenclature

## Amplifier Units

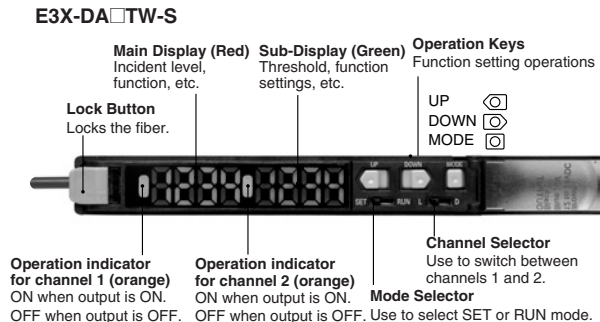
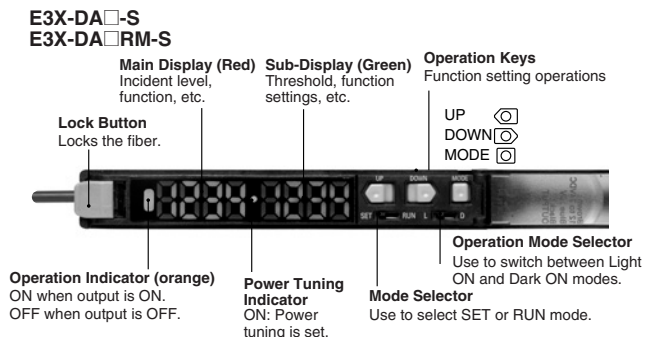

## Adjustment Methods

### 1. Setting the Operation Mode

The operation mode is set with the Operation Mode Selector.

Operation mode		Operation
Light ON	L·ON	L  (Factory-set)
Dark ON	D·ON	D

- E3X-DA□TW-S: The operation mode is set with the channel selector. Refer to *Section 5. Setting Functions in SET Mode on page 23.*
- E3X-DA□TW-S: Set the Channel Selector to the desired channel before making any adjustments or settings. This is true for all adjustments and settings.

### 2. Adjusting the Power (RUN Mode)

The current incident light level can be adjusted to near the power tuning target value (default: 2,000).

- Confirm that the MODE key setting is PTUN (power tuning). The default setting is PTUN. Refer to *Section 5. Setting Functions in SET Mode on page 23*

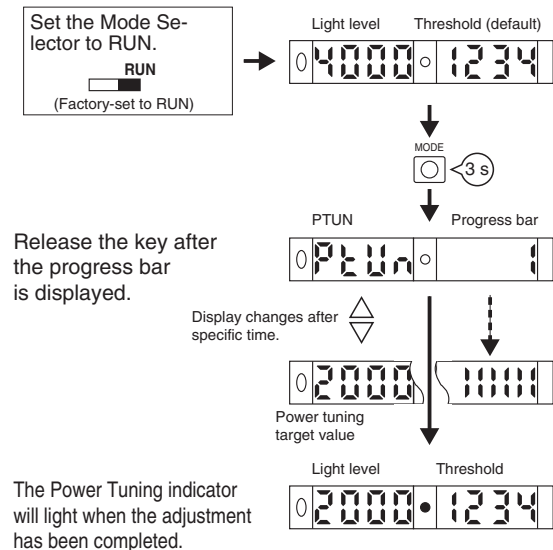

To restore the default power settings:

"OFF" will flash twice.

The Power Tuning indicator will go out when the default setting has been restored.

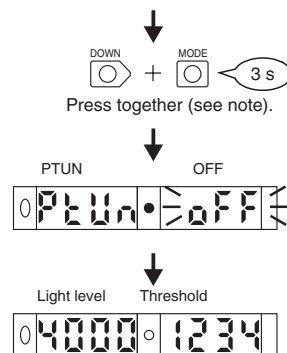

### \* Setting Errors

An error has occurred if one of the following displays appears after the progress bar is displayed.

Display	Error	Action
Flashes twice 0 Ptun Over	<b>Over Error</b> The incident light level is too low for the power tuning target value.	The power will not be tuned. The power can be increased up to approximately 5 times the incident light value.
Flashes twice 0 Ptun Botm	<b>Bottom Error</b> The incident light level is too high for the power tuning target value.	The power will be turned to the minimum level. The power can be decreased down to approximately 1/25th the incident light value.

**Note:** Press the DOWN key right after pressing the MODE key.

### 3. Setting Thresholds Manually (RUN Mode)

A threshold can be set manually. A threshold value can also be fine-tuned using manual setting after teaching.

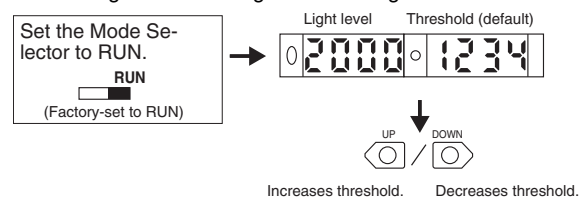

- Even if the display method for display switching is changed, the threshold will appear on the sub-display when the key is pressed.

### 4. Teaching the Threshold Value (SET Mode)

- There are four methods that can be used for teaching, as described below. Use the method most suitable for the application.
- An error has occurred if OVER, LO, or NEAR is displayed on the sub-display. Repeat the operation from the beginning.

#### 4-1. Setting the Threshold at Maximum Sensitivity

The threshold can be set at the maximum sensitivity. This method is ideal when using a Through-beam Fiber Unit to detect workpieces so that detection is not influenced to any great degree by dust and other environmental factors.

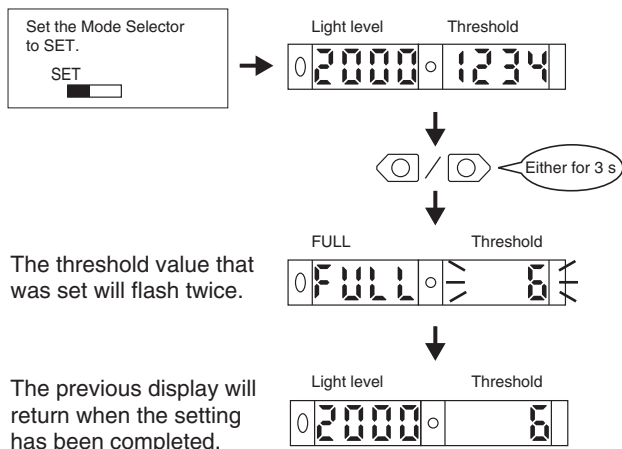

#### 4-2. Teaching a Through-beam Fiber Unit without a Workpiece

A value about 6% less than the incident light level can be set as the threshold value. This method is ideal when detecting very small differences in light level, such as when detecting very fine or transparent objects.

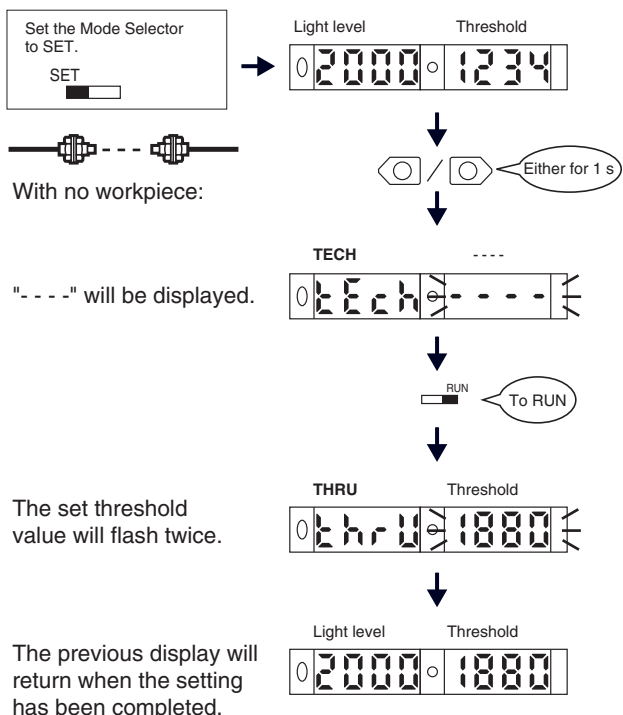

#### 4-3. Teaching a Reflective Fiber Unit without a Workpiece

A value about 6% greater than the incident light level can be set as the threshold value. This method is ideal when using a Reflective Fiber Unit to detect workpieces so that detection is not influenced to any great degree by dust and other environmental factors.

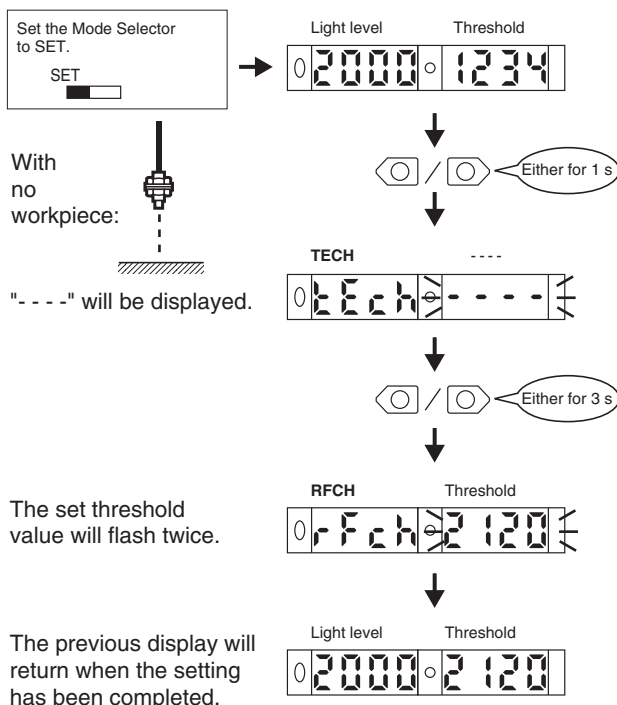

#### 4-4. Teaching With and Without a Workpiece

Teaching can be performed twice, once with and once without a workpiece, and the value between the two measured value can be set as the threshold.

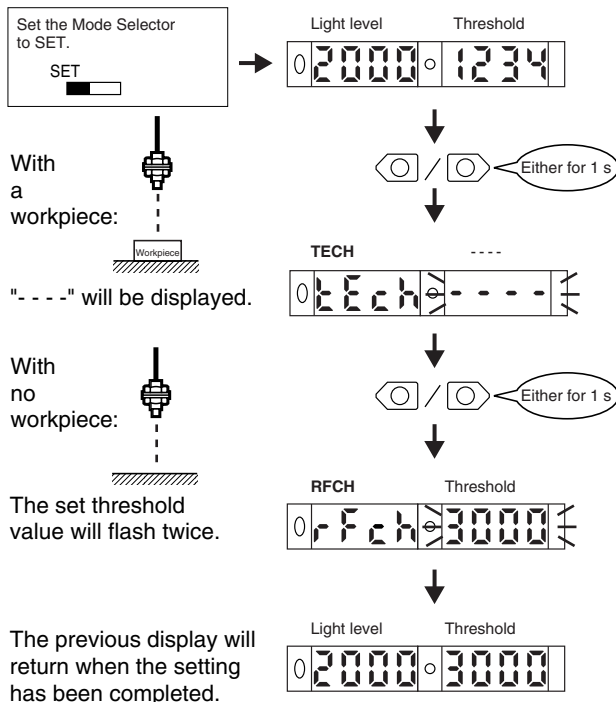

## 5. Setting Functions in SET Mode

• The default settings are shown in the transition boxes between functions.

### For the E3X-DA□-S

Teaching: Refer to Section 4. Teaching the Threshold Value (SET Mode) on page 22.

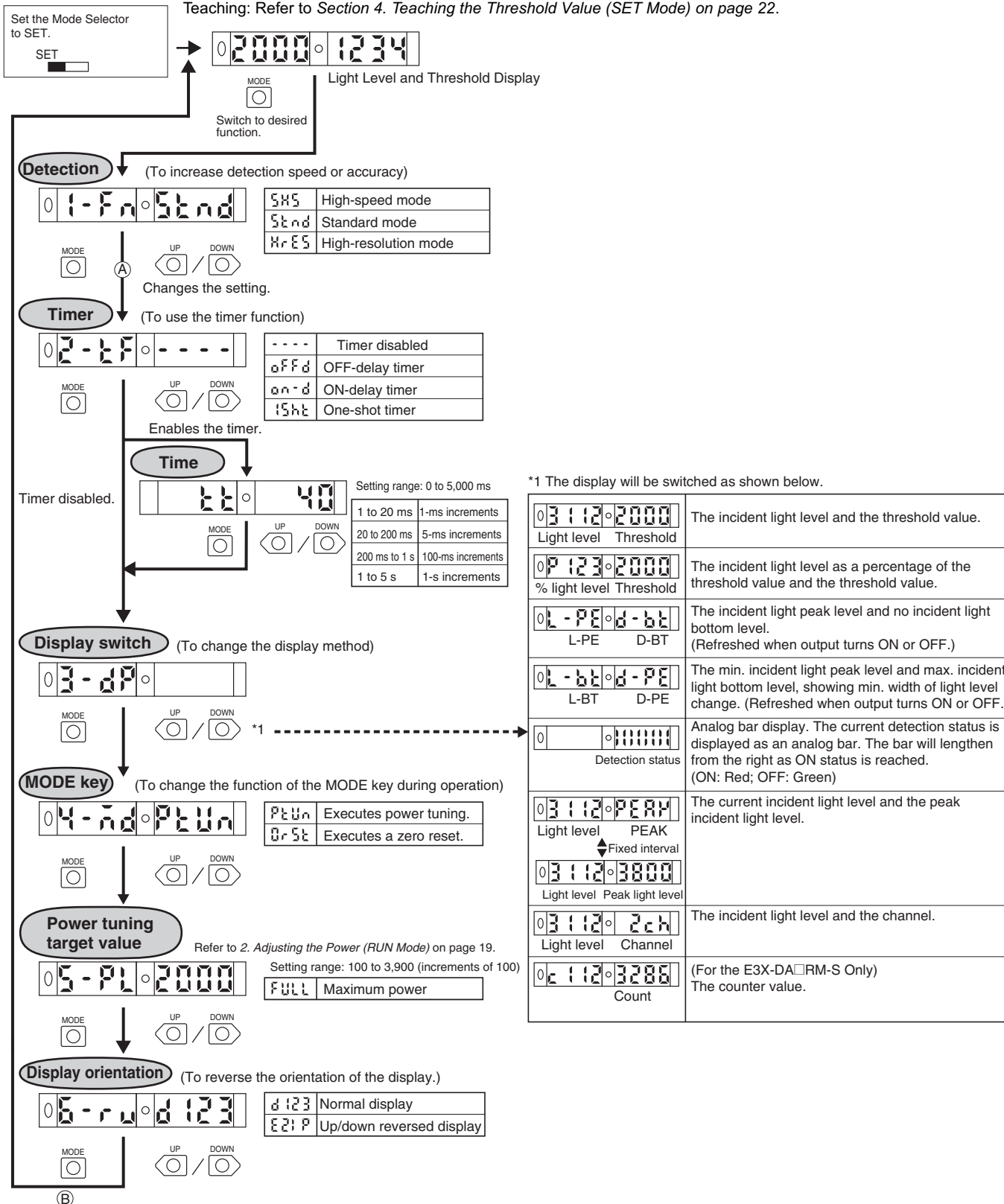

### For the E3X-DA□TW-S

Teaching: Refer to Section 4. Teaching the Threshold Value (SET Mode) on page 22

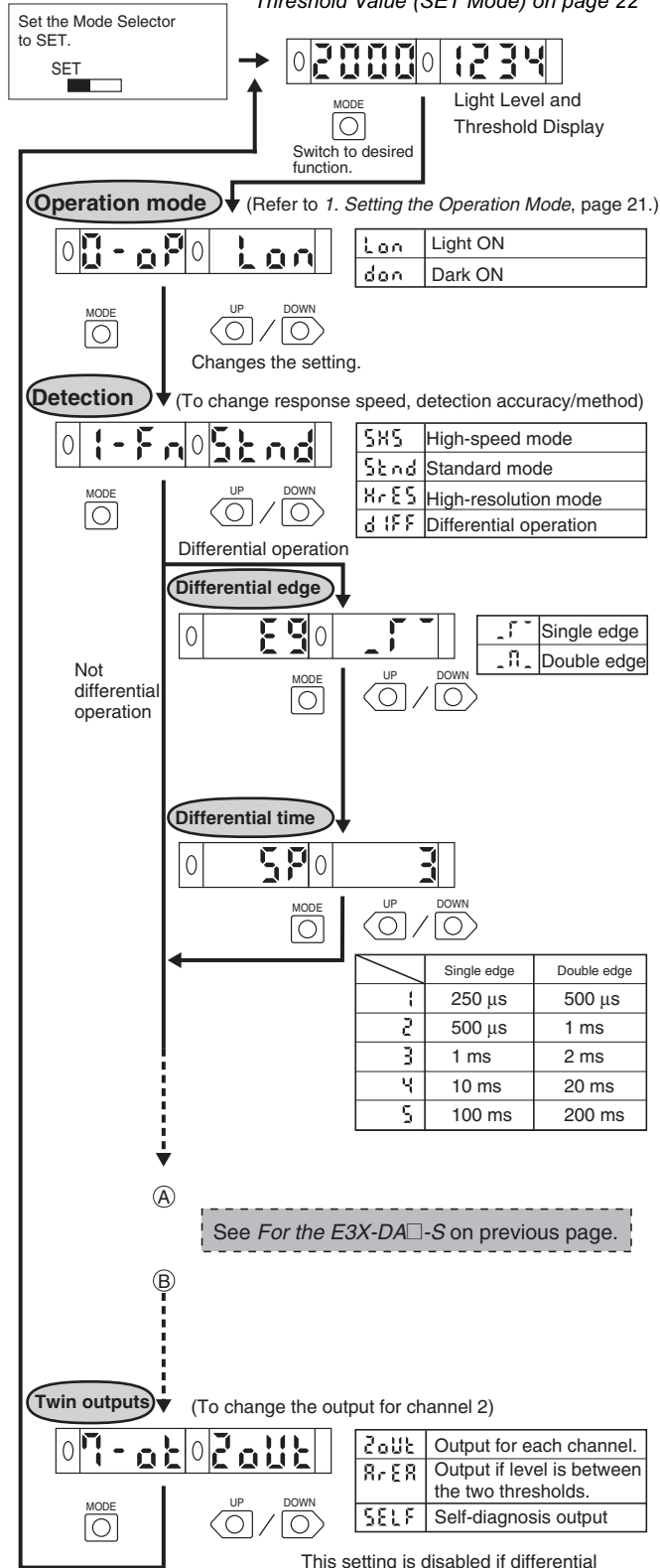

This setting is disabled if differential operation is set for the detection function. (Alarm outputs are always used for differential operation.)

### For the E3X-DA□RM-S

Teaching: Refer to Section 4. Teaching the Threshold Value (SET Mode) on page 22.

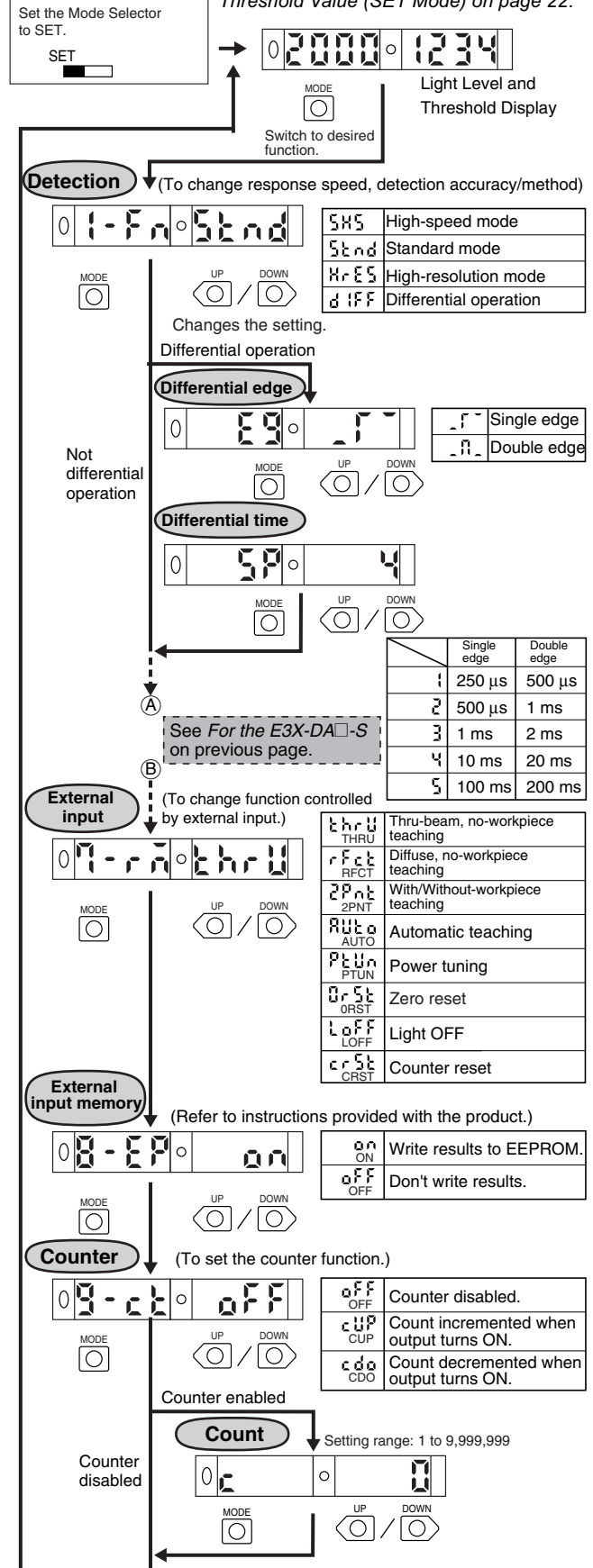



## 6. Convenient Functions

### 6-1. Zeroing the Digital Display

The incident light level on the digital display can be set to 0.

- Change the function to 0RST (zero reset) with the MODE key. The default setting is PTUN. Refer to Section 5. Setting Functions in SET Mode on page 23.

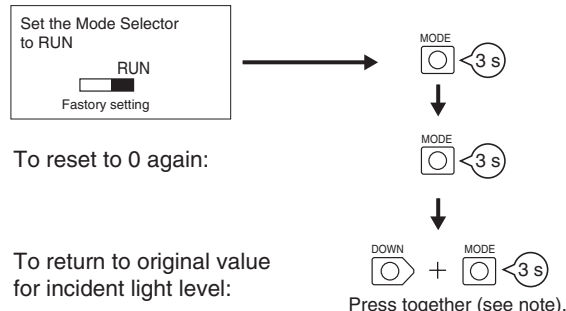

To reset to 0 again:

To return to original value for incident light level:

### 6-2. Locking the Keys

All key operations can be disabled.

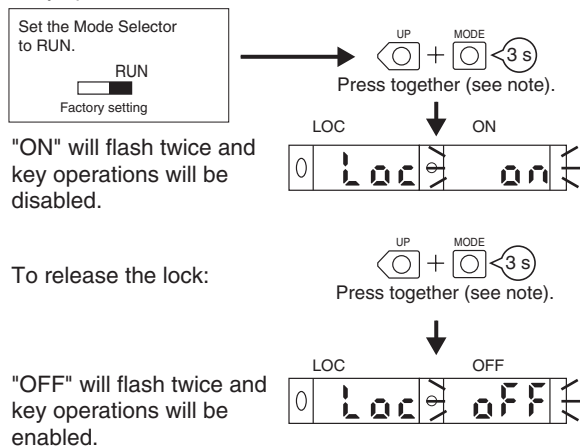

"ON" will flash twice and key operations will be disabled.

To release the lock:

"OFF" will flash twice and key operations will be enabled.

\* If a key is pressed while key operations are locked, "LOC" will flash twice on the display to indicate that key operations have been disabled.



**Note:** Press the DOWN key right after pressing the MODE key.

### 6-3. Initializing Settings

All settings can be returned to their original default settings.

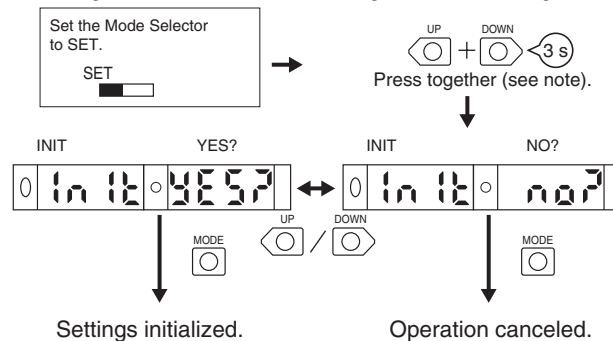

# Safety Precautions

**Note:** In addition to the precautions in this data sheet, please read and observe the common precautions in the instruction sheet accompanying the product.

## Amplifier Unit

### Installation

#### Operation After Turning Power ON

The Amplifier Unit is ready to operate within 200 ms after the power supply is turned ON. If the Sensor and load are connected to separate power supplies, be sure to turn ON the power supply for the Sensor first.

### Mounting

#### Connecting and Disconnecting Connectors

##### Mounting Connectors

1. Insert the Master or Slave Connector into the Amplifier Unit until it clicks into place.

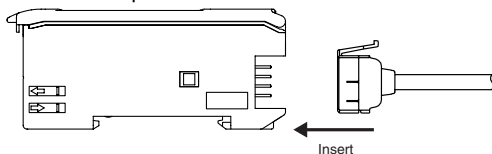

2. Attach the protector seals (provided as accessories) to the sides of master and slave connectors that are not connected.

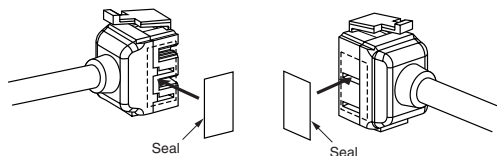

**Note:** Attach the seals to the sides with grooves

##### Removing Connectors

1. Slide the slave Amplifier Unit(s) for which the Connector is to be removed away from the rest of the group.
2. After the Amplifier Unit(s) has been separated, press down on the lever on the Connector and remove it. (Do not attempt to remove Connectors without separating them from other Amplifier Units first.)

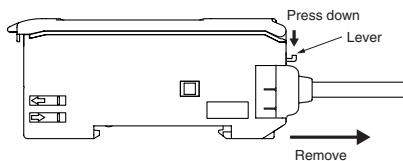

#### Joining and Removing Amplifier Units

##### Joining Amplifier Units

1. Mount the Amplifier Units one at a time onto the DIN track.

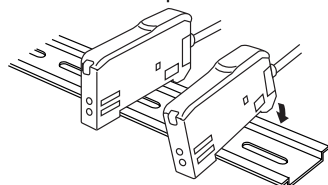

2. Slide the Amplifier Units together, line up the clips, and press the Amplifier Units together until they click into place.

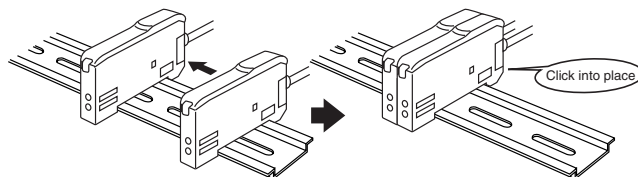

##### Separating Amplifier Units

Slide Amplifier Units away from each other, and remove from the DIN track one at a time. (Do not attempt to remove Amplifier Units from the DIN track without separating them first.)

- Note:**
1. The specifications for ambient temperature will vary according to the number of Amplifier Units used together. For details, refer to *Ratings/Characteristics*.
  2. Always turn OFF the power supply before joining or separating Amplifier Units.

#### Mounting the End Plate (PFP-M)

An End Plate should be used if there is a possibility of the Amplifier Unit moving, e.g., due to vibration. If a Mobile Console is going to be mounted, connect the End Plate in the direction shown in the following diagram.

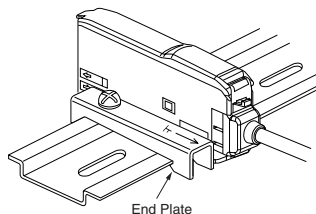

#### Mounting the Mobile Console Head

Leave a gap of at least 20 mm between the nearest Amplifier Unit and the Mobile Console head.

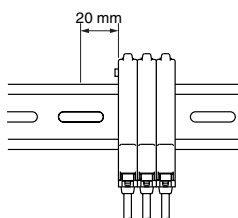

## Fiber Connection

The E3X Amplifier Unit has a lock button for easy connection of the Fiber Unit. Connect or disconnect the fibers using the following procedures:

### 1. Connection

Open the protective cover, insert the fibers according to the fiber insertion marks on the side of the Amplifier Unit, and lower the lock button.

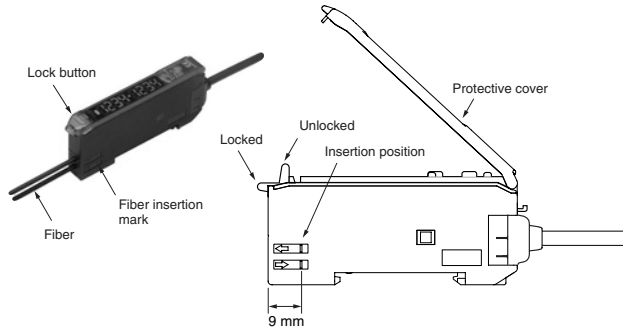

### Fibers with E39-F9 Attachment

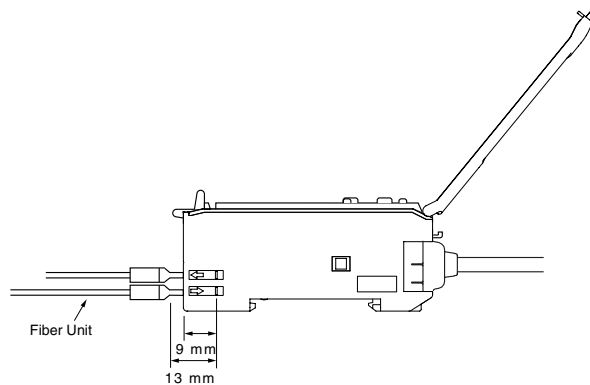

### Fibers That Cannot Be Free-Cut (with Sleeves)

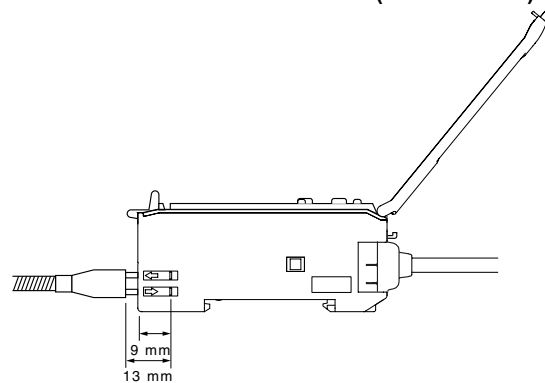

### 2. Disconnecting Fibers

Remove the protective cover and raise the lock button to pull out the fibers.

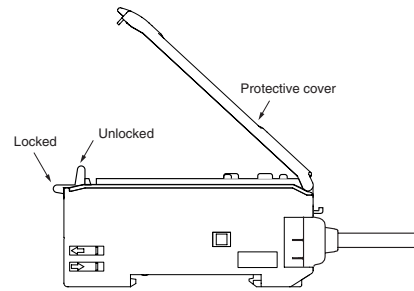

- Note:**
1. To maintain the fiber properties, confirm that the lock is released before removing the fibers.
  2. Be sure to lock or unlock the lock button within an ambient temperature range between  $-10^{\circ}\text{C}$  and  $40^{\circ}\text{C}$ .

## Adjustments

### Mutual Interference Protection Function

There may be some instability in the digital display values due to light from other sensors. If this occurs, decrease the sensitivity (i.e., decrease the power or increase the threshold) to perform stable detection.

### EEPROM Writing Error

If the data is not written to the EEPROM correctly due to a power failure or static-electric noise, initialize the settings with the keys on the Amplifier Unit. ERR/EEP will flash on the display when a writing error has occurred.

### Optical Communications

Several Amplifier Units can be slid together and used in groups. Do not, however, slide the Amplifier Units or attempt to remove any of the Amplifier Units during operation.

## Other Precautions

### Protective Cover

Always keep the protective cover in place when using the Amplifier Unit.

### Mobile Console

Use the E3X-MC11-S Mobile Console for the E3X-DA-S-series Amplifier Units. Other Mobile Consoles, such as the E3X-MC11, cannot be used.

# Dimensions

Unit: mm (inch)

## Amplifier Units

### Amplifier Units with Cables

- E3X-DA11-S
- E3X-DA41-S
- E3X-DAG11-S
- E3X-DAG41-S
- E3X-DAB11-S
- E3X-DAB41-S
- E3X-DA11RM-S
- E3X-DA41RM-S
- E3X-DA11TW-S
- E3X-DA41TW-S

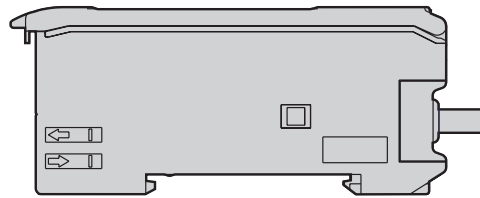
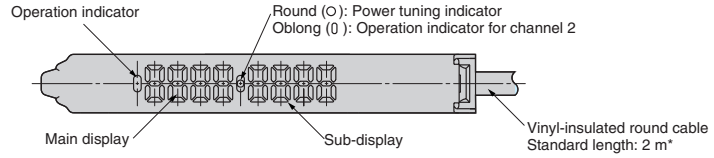

\*Cable Specifications

E3X-DA11-S/DA41-S/DAG11-S/DAG41-S/DAB11-S/DAB41-S	A 4-dia., 3-conductor (conductor cross-sectional area: 0.2 mm <sup>2</sup> ; insulation diameter: 1.1 mm)
E3X-DA11TW-S/DA41TW-S/DA11RM-S/DA41RM-S	A 4-dia., 4-conductor (conductor cross-sectional area: 0.2 mm <sup>2</sup> ; insulation diameter: 1.1 mm)



With Mounting Bracket Attached

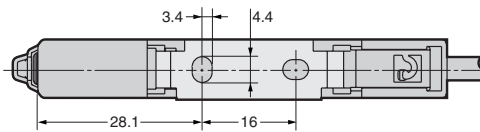
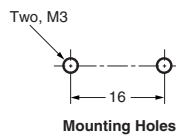
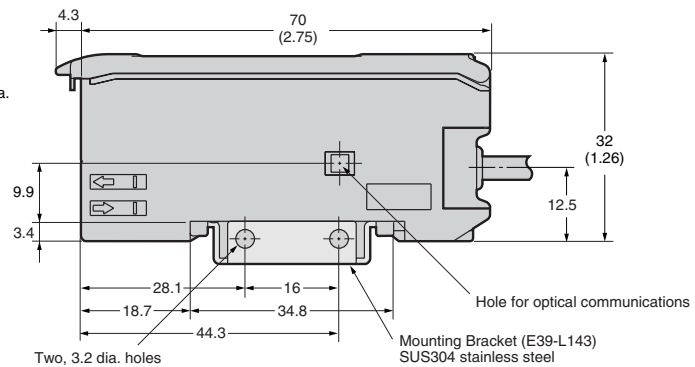
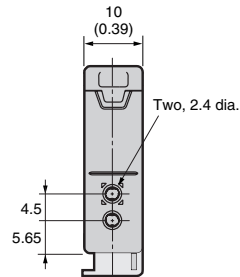
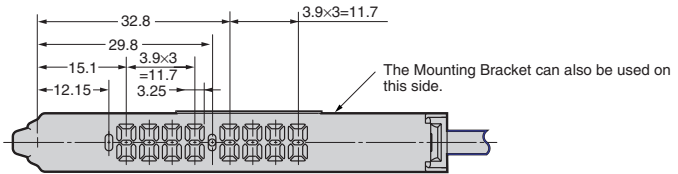

## Amplifier Units with Connectors

- E3X-DA6-S
- E3X-DA8-S
- E3X-DAG6-S
- E3X-DAG8-S
- E3X-DAB6-S
- E3X-DAB8-S
- E3X-DA6RM-S
- E3X-DA8RM-S
- E3X-DA6TW-S
- E3X-DA8TW-S

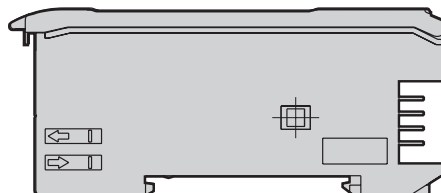
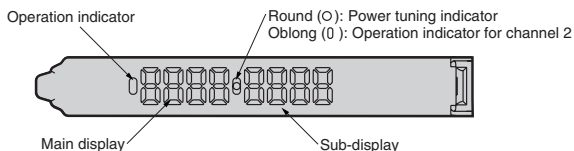

With Mounting Bracket Attached

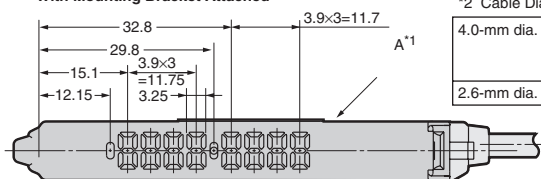

\*1 The Mounting Bracket can also be used on this side.

\*2 Cable Diameters

4.0-mm dia.	E3X-CN11 (3 conductors) E3X-CN21 (4 conductors) E3X-CN22 (2 conductors)
2.6-mm dia.	E3X-CN12 (1 conductor)

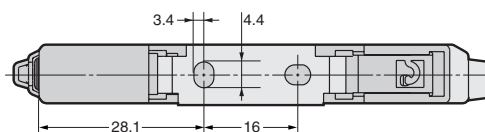
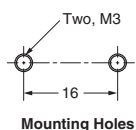
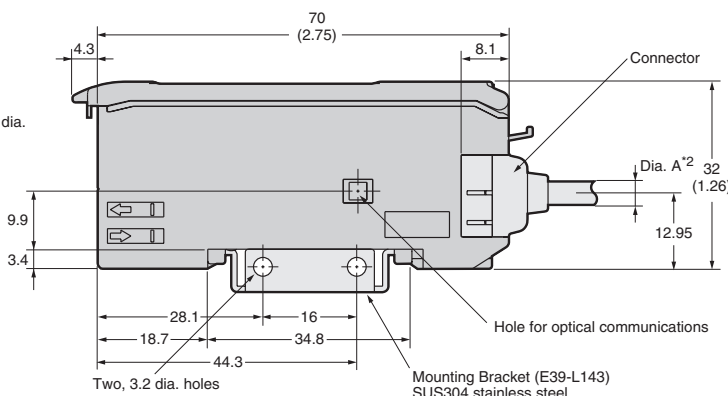
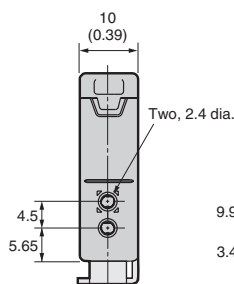

## Amplifier Unit Connectors

### Master Connectors

- E3X-CN11
- E3X-CN21

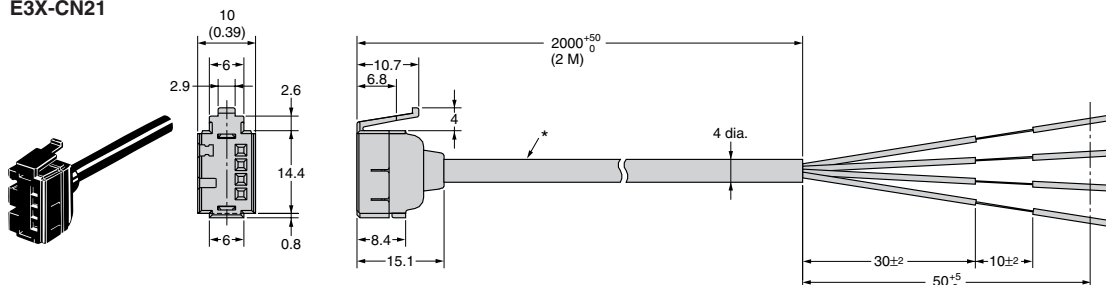

\*E3X-CN11: A 4-dia., 3-conductor, vinyl-insulated round cable (conductor cross-sectional area: 0.2 mm<sup>2</sup>; insulation diameter: 1.1 mm) is used.

E3X-CN21: A 4-dia., 4-conductor, vinyl-insulated round cable (conductor cross-

Unit: mm (inch)

## Slave Connectors

E3X-CN12  
E3X-CN22

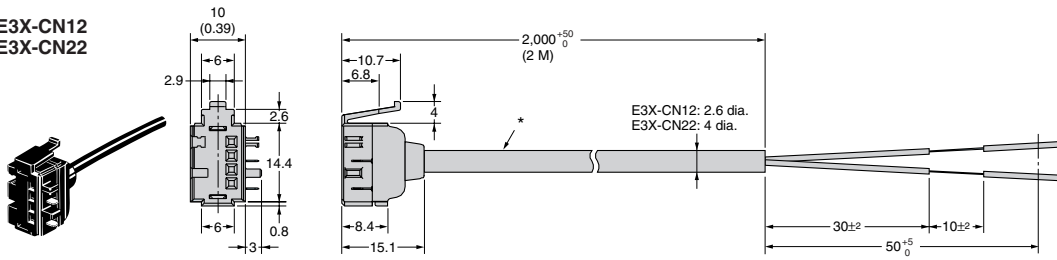

\*E3X-CN12: A 2.6-dia., single-conductor, vinyl-insulated round cable (conductor cross-sectional area: 0.2 mm<sup>2</sup>; insulation diameter: 1.1 mm) is used.  
E3X-CN22: A 4-dia., 2-conductor, vinyl-insulated round cable (conductor cross-sectional area: 0.2 mm<sup>2</sup>; insulation diameter: 1.1 mm) is used.

## Mobile Console

E3X-MC11-S

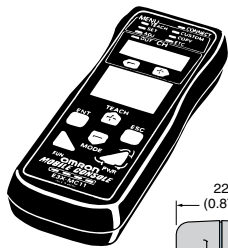

### Mobile Console

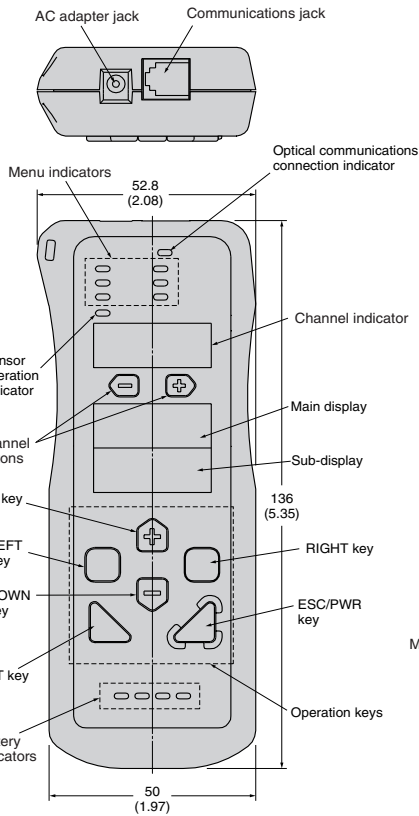

### Mobile Console Head

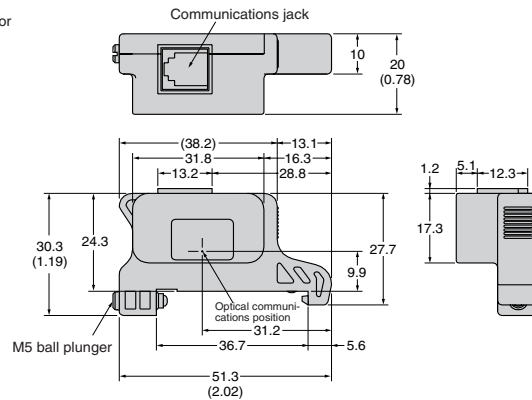
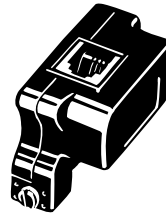

## ■ Fiber Optic Cables

Unit: mm (inch)

### Through-beam Fiber Units (Sold in Pairs)

(Free-cut) Indicates models that allow free cutting. Models without this mark do not allow free cutting.)

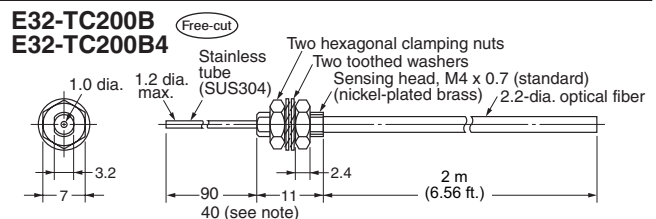
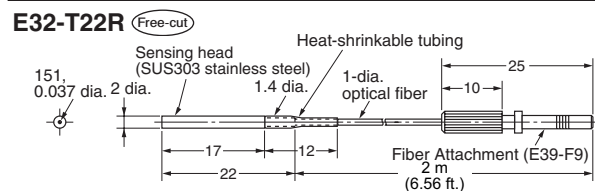
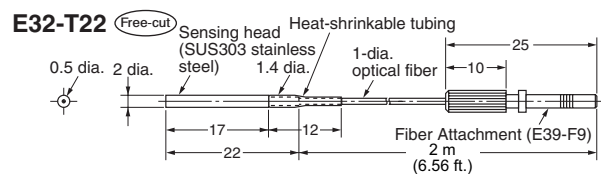
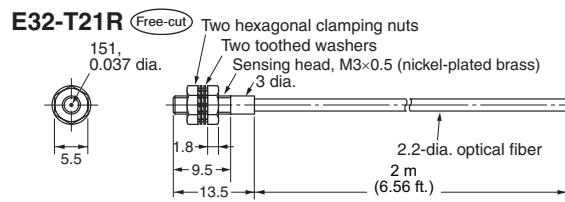
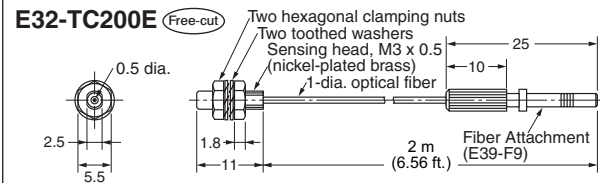
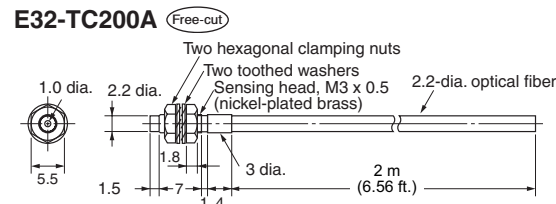
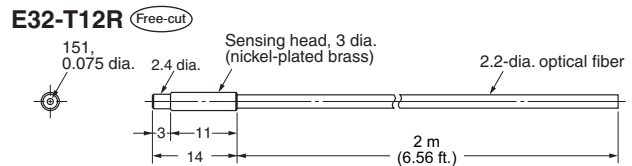
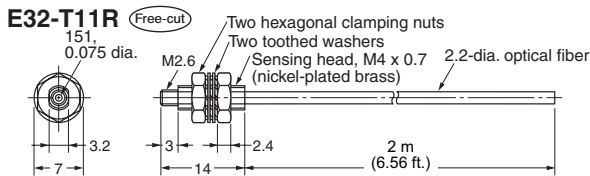
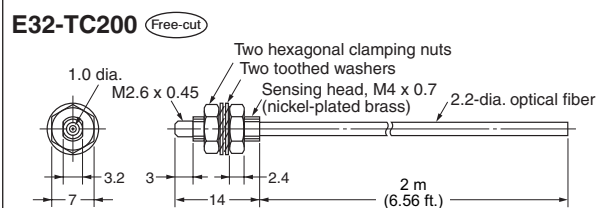
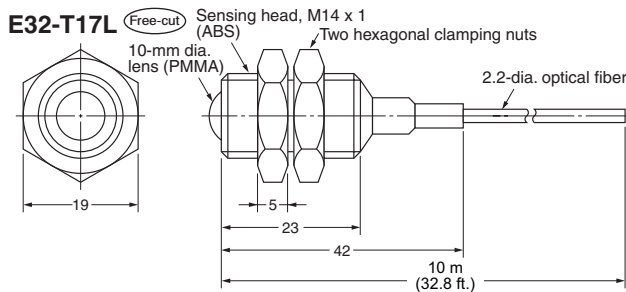
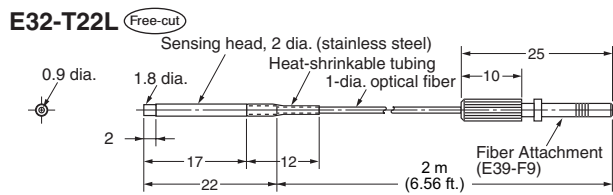
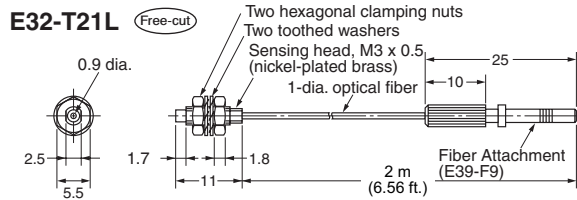
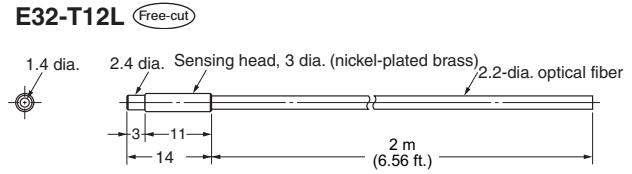
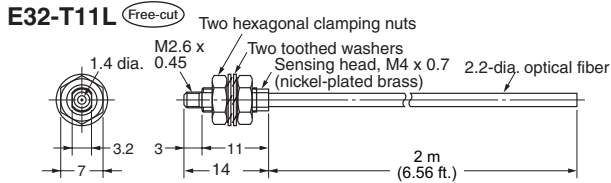

Note: The value in the parentheses is for the E32-TC200B4.

Unit: mm (inch)

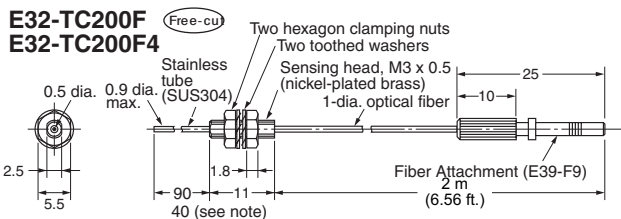

**Note:** The value in the parentheses is for the E32-TC200F4.

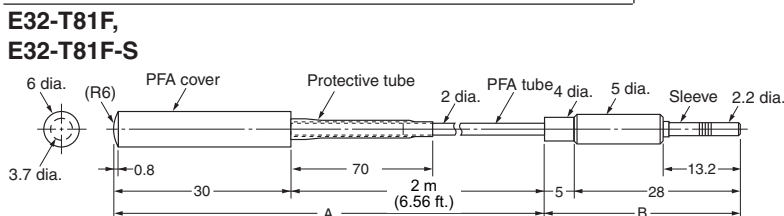
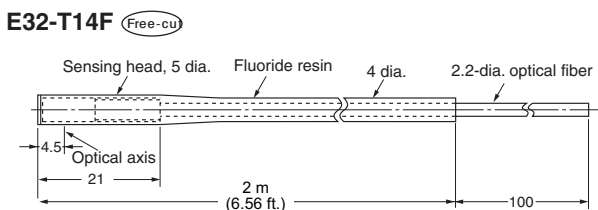
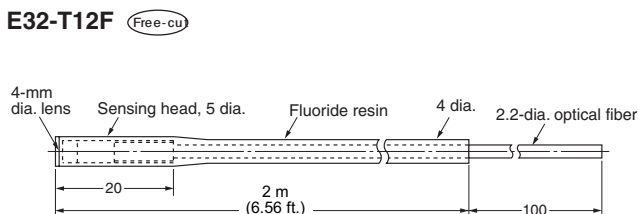
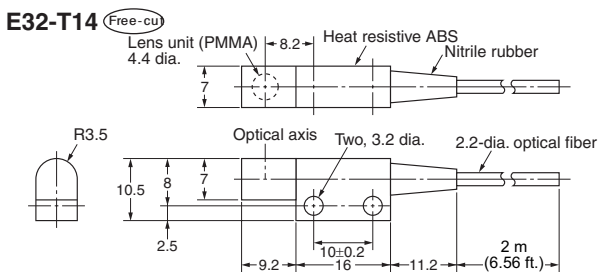
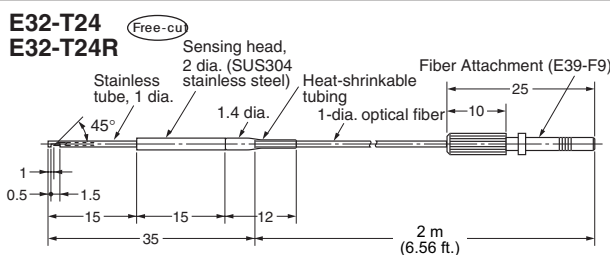
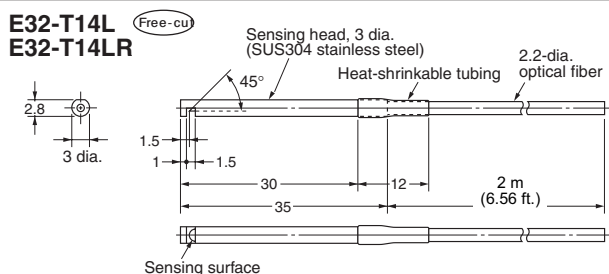
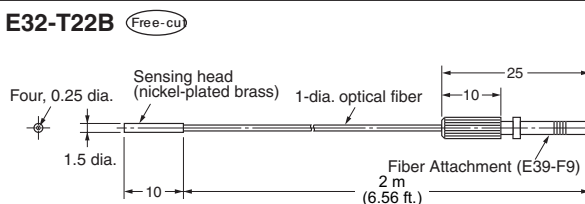
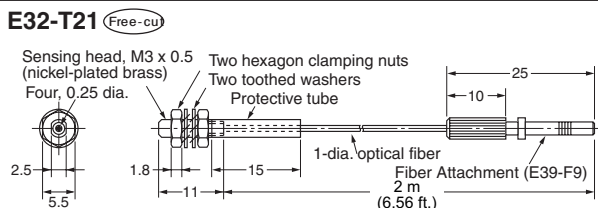
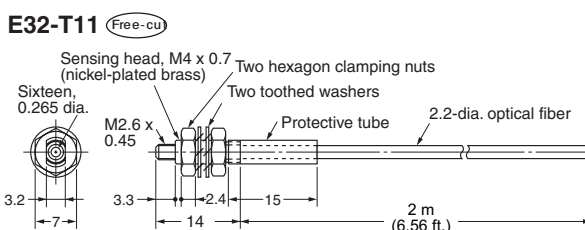

**Note:** Section A resists 200°C and section B resists 110°C.

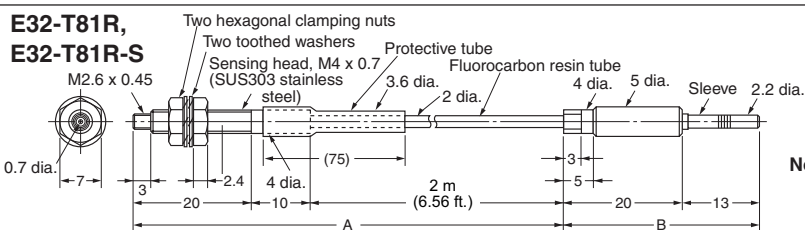

**Note:** Section A resists 200°C and section B resists 110°C.



**E32-T51** (Free-cu)

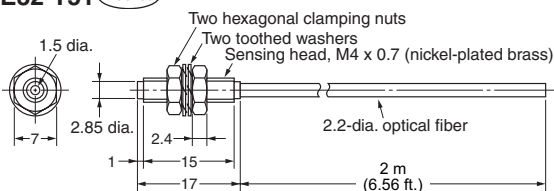

**Note:** Resistant temperature is 150°C.  
Resistant temperature is 130°C when used continuously.

**E32-T61, E32T61-S**

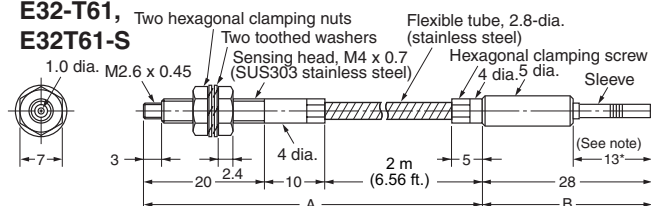

**Note:** Section A resists 300°C and section B (which is inserted to the Amplifier) resists 110°C.  
The operating temperature of the section to be inserted into the Sensor (marked with \*) must be within the operating temperature range of the Amplifier.

**E32-T54** (Free-cu)

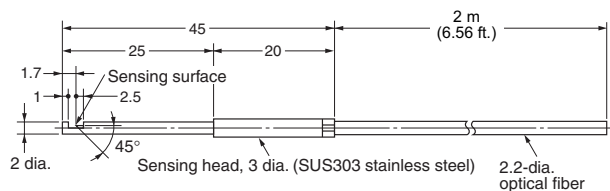

**Note:** Resistant temperature is 150°C.  
Resistant temperature is 130°C when used continuously.

**E32-T84S, E32-T84S-S**

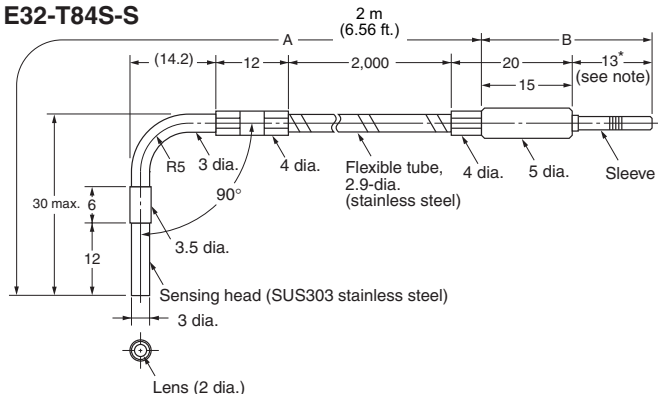

**Note:** Section A resists 200°C and section B (which is inserted to the Amplifier) resists 110°C.  
The operating temperature of section to be inserted into the Sensor (marked with \*) must be within the operating temperature range of the Amplifier.

**E32-G14** (Free-cu)

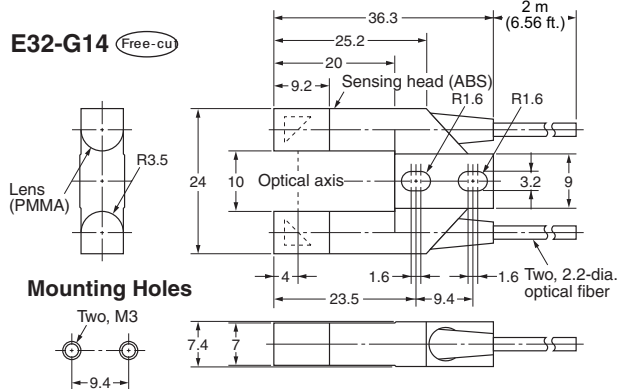

**E32-T22S** (Free-cu)

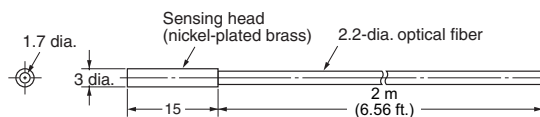

**E32-T24S** (Free-cu)

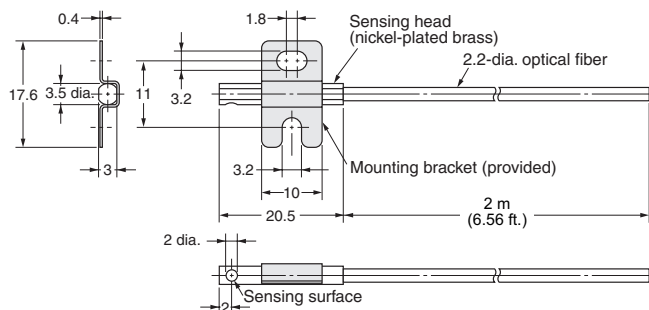

**E32-M21**

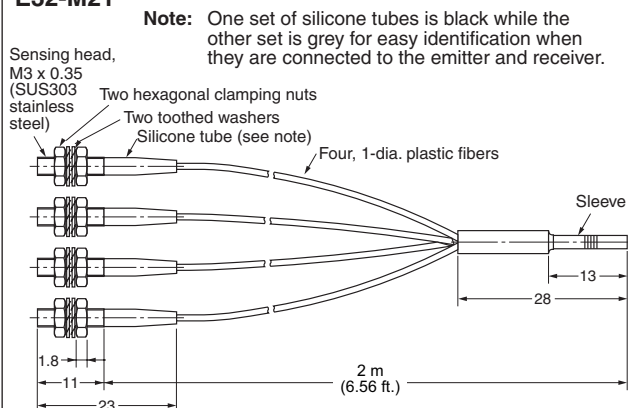

**Note:** One set of silicone tubes is black while the other set is grey for easy identification when they are connected to the emitter and receiver.

Unit: mm (inch)

**E32-T16W**  
**E32-T16WR**

(Free-cut)

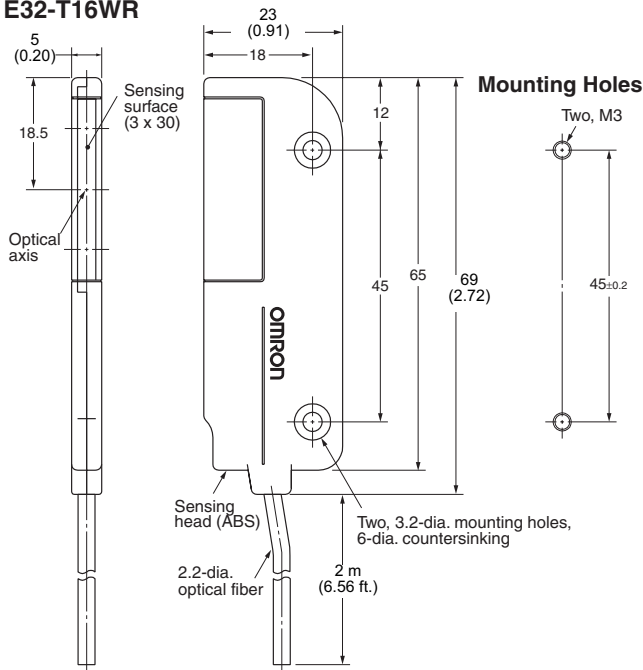

**E32-T16J**  
**E32-T16JR**

(Free-cut)

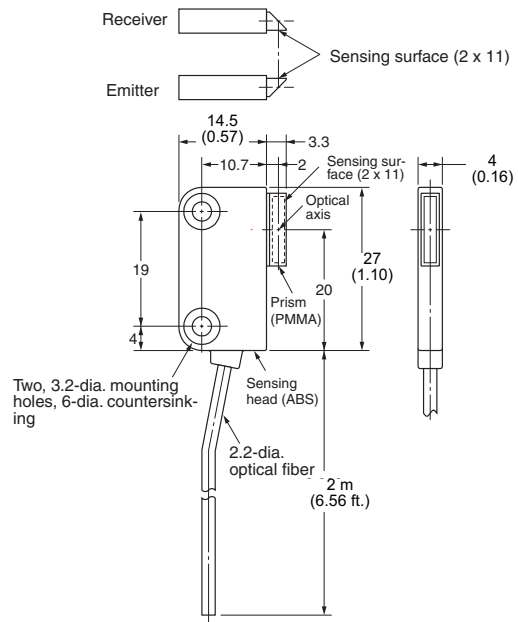

**E32-T16**

(Free-cut)

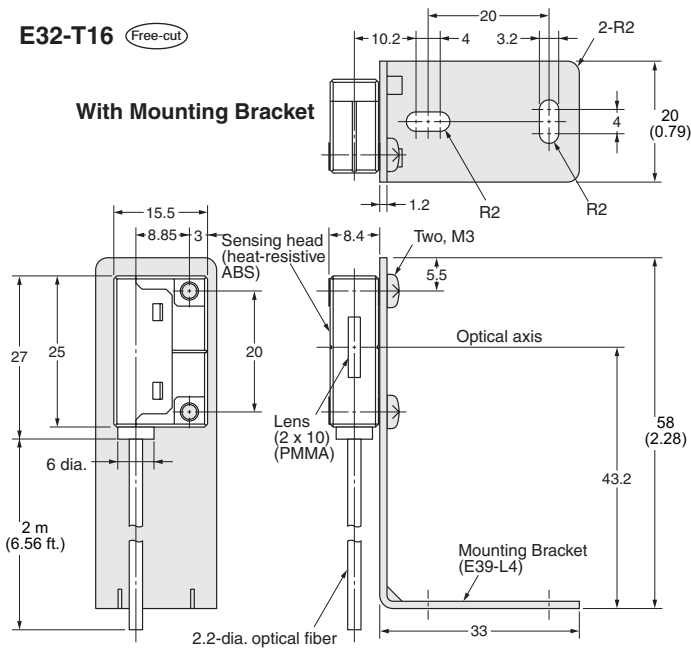

**Mounting Holes**

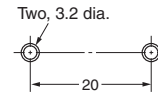

**0.5-mm-wide Slit Seal**  
(Supplied with the Unit in Pairs)

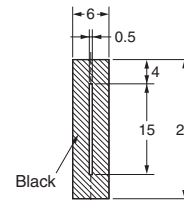

**1-mm-wide Slit Seal**  
(Supplied with the Unit in Pairs)

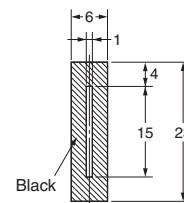

**E32-T16P** (Free-cut)  
**E32-T16PR**

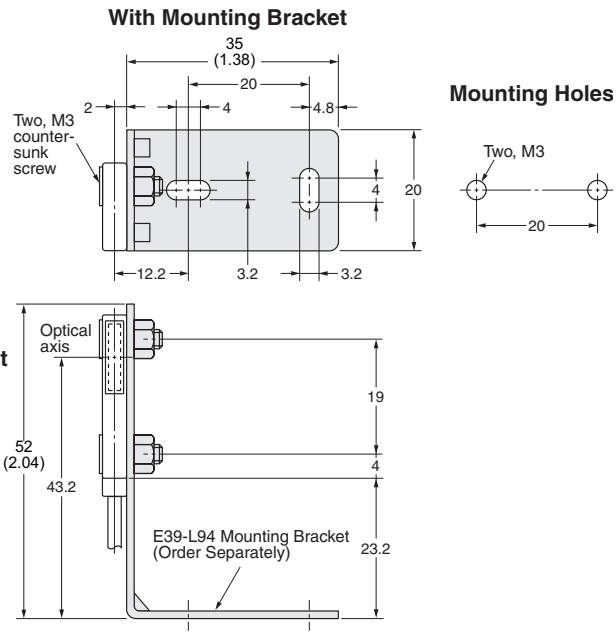
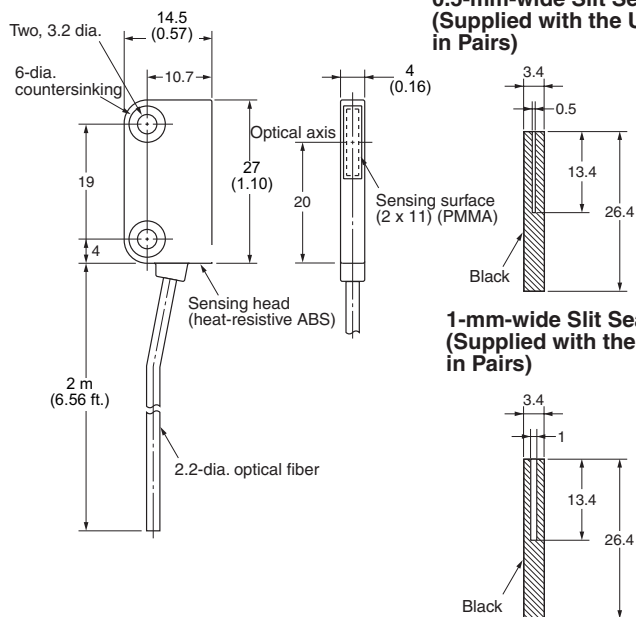

**E32-T11F** (Free-cut)

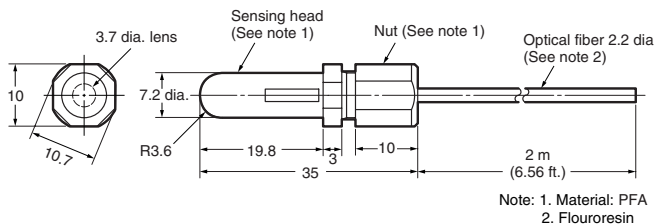

**E32-T11U** (Free-cut)

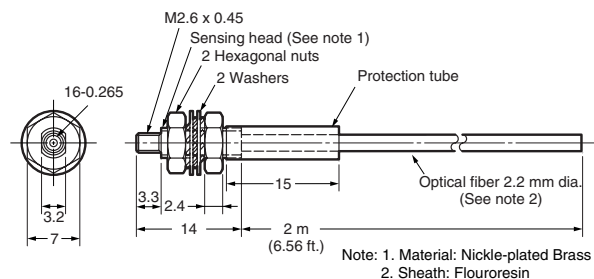

## Diffuse Fiber Units

Unit: mm (inch)

**Free-cut** Indicates models that allow free cutting. Models without this mark do not allow free cutting.

**E32-D11L** (Free-cut)

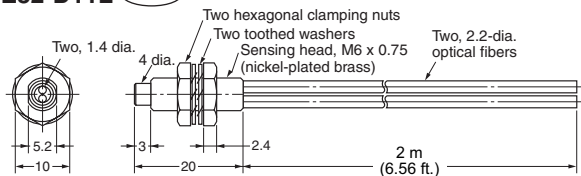

**E32-D12** (Free-cut)

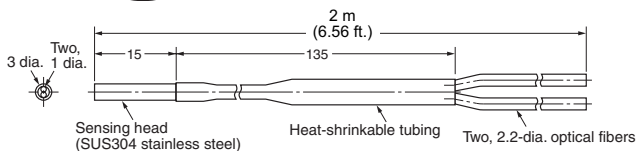

**E32-D21L** (Free-cut)

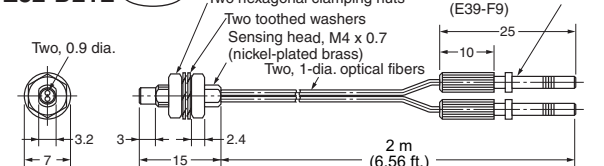

**E32-D22L** (Free-cut)

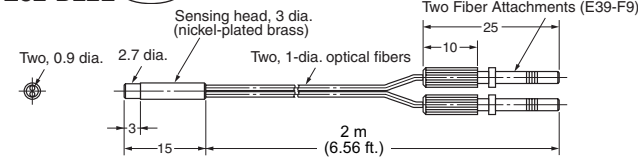

**E32-DC200** (Free-cut)

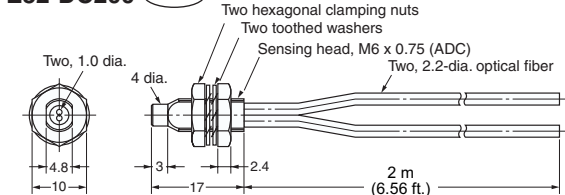

**E32-D11R** (Free-cut)

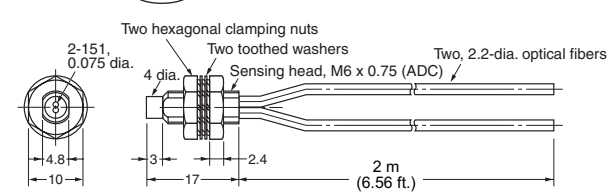

**E32-D12R** (Free-cut)

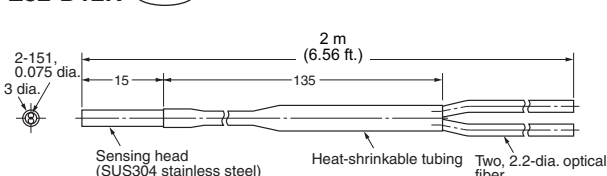

**E32-DC200E** (Free-cut)

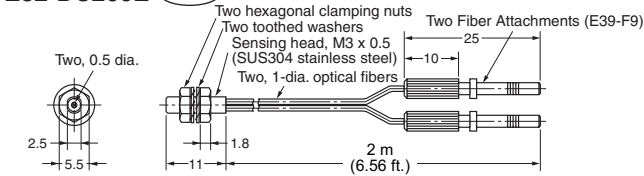

**E32-D21R**

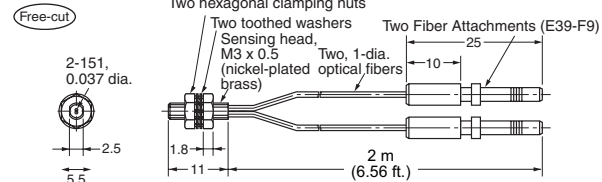

**E32-D22R** (Free-cut)

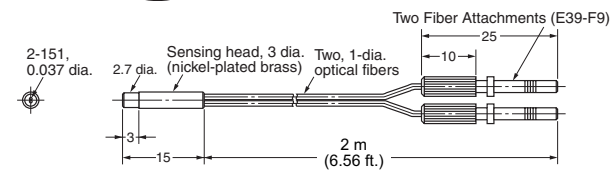

**E32-DC200B** (Free-cut)  
**E32-DC200B4**

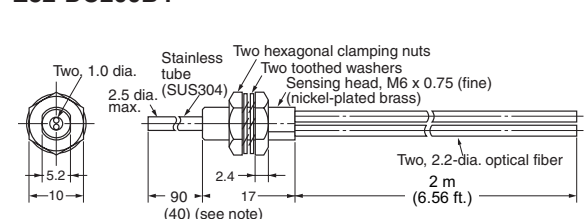

**Note:** The value in the parentheses is for the E32-DC200B4.

**E32-DC200F** (Free-cut)  
**E32-DC200F4**

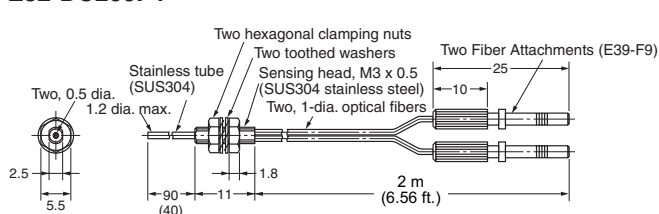

**Note:** The value in the parentheses is for the E32-DC200F4.

**E32-D33** (Free-cut)

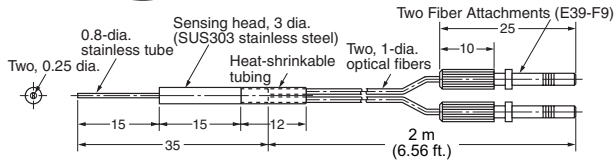

**E32-D331**

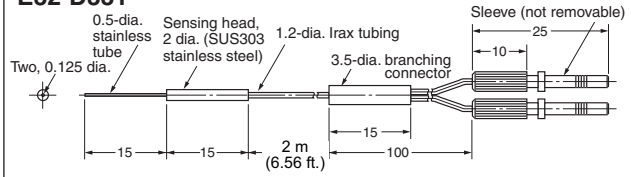

**E32-D11** (Free-cut)

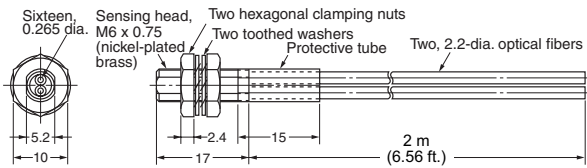

**E32-D21** (Free-cut)

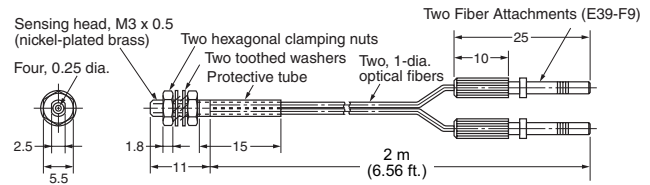

**E32-D21B** (Free-cut)

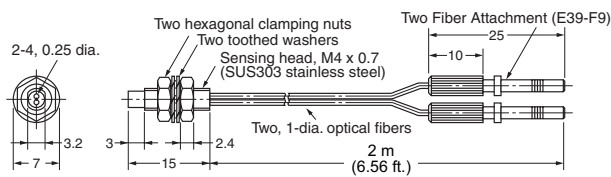

**E32-D22B**

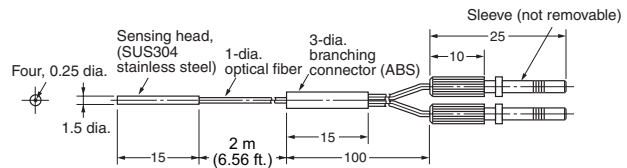

**E32-CC200** (Free-cut)

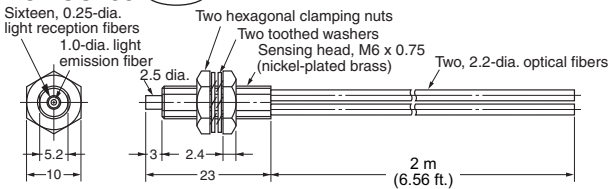

**E32-D32L** (Free-cut)

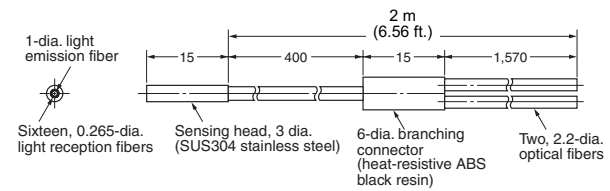

**Note:** The fiber for the emitter is identified by a white line.

**Note:** The fiber for the emitter is identified by a yellow dotted line.

**E32-C31** (Free-cut)

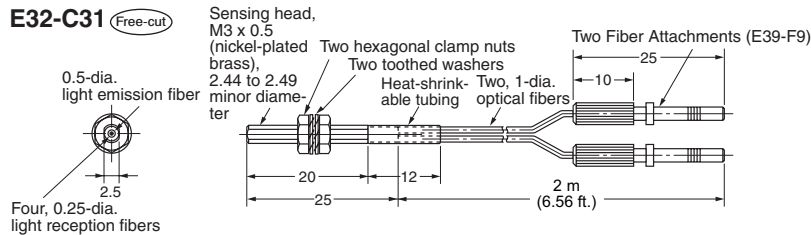

**Note:** The fiber for the emitter is identified by a white line.

**E32-C41**

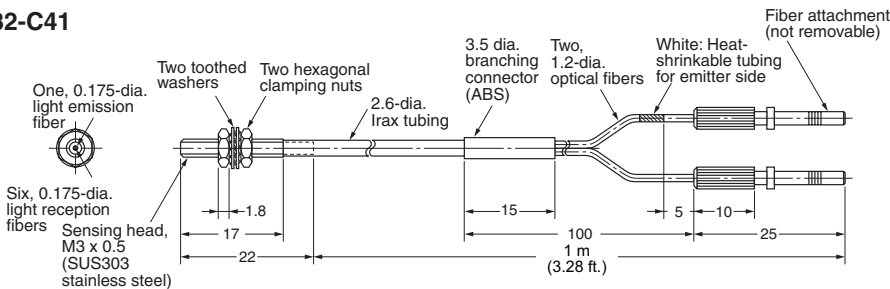

Unit: mm (inch)

**E32-C42**

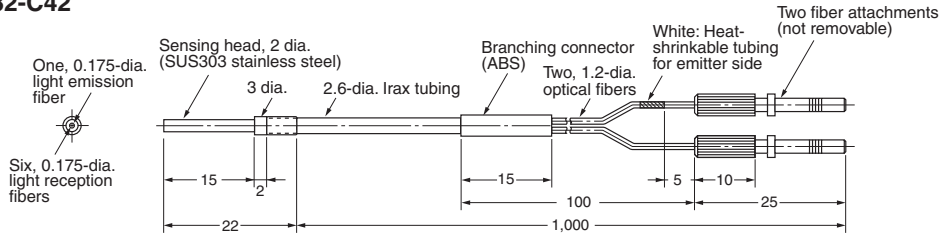

**E32-D32** (Free-cu)

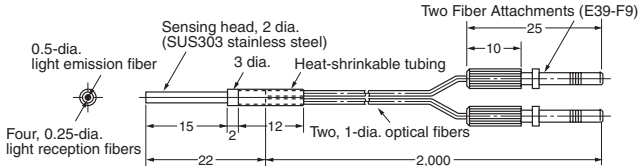

**Note:** The fiber for the emitter is identified by a white line.

**E32-D14L** (Free-cu)  
**E32-D14LR**

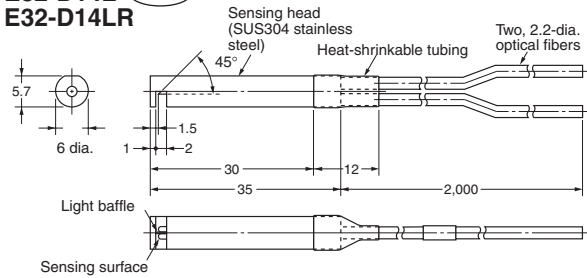

**E32-D24** (Free-cu)  
**E32-D24R**

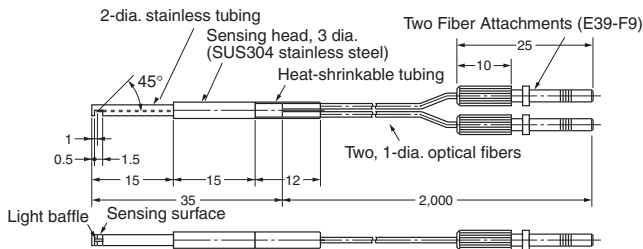

**E32-D12F** (Free-cu)

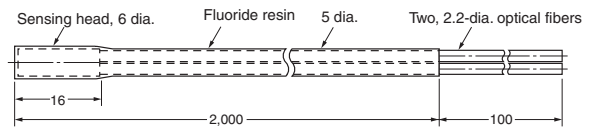

**E32-D51** (Free-cu)

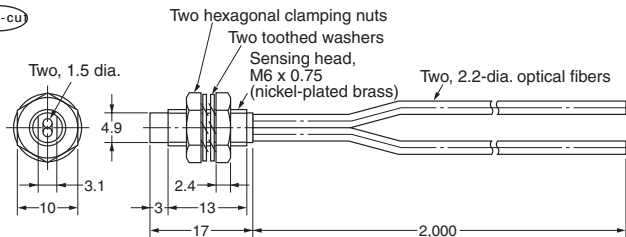

**Note:** Resistant temperature is 150°C.  
Resistant temperature is 130°C when used continuously.

**E32-D61**  
**E32-D61-S**

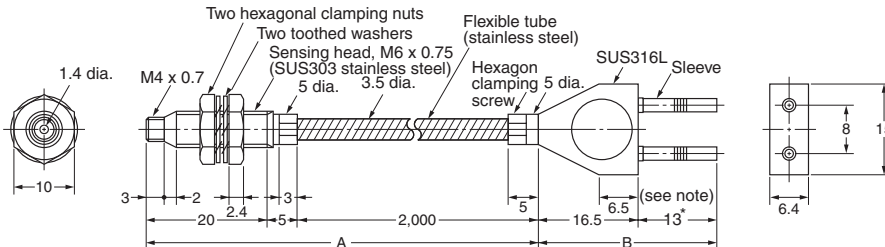

**Note:** Section A resists 300°C and section B (which is inserted to the Amplifier) resists 110°C. The operating temperature of the section to be inserted into the Sensor (marked with \*) must be within the operating temperature range of the Amplifier.

Above diagram for E32-D61. For the E32-D61-S, contact your Omron representative.



Unit: mm (inch)

**E32-L24L** (Free-cut)

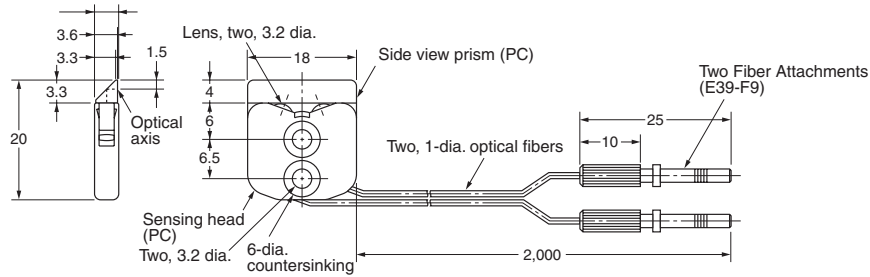

**E32-L25L** (Free-cut)

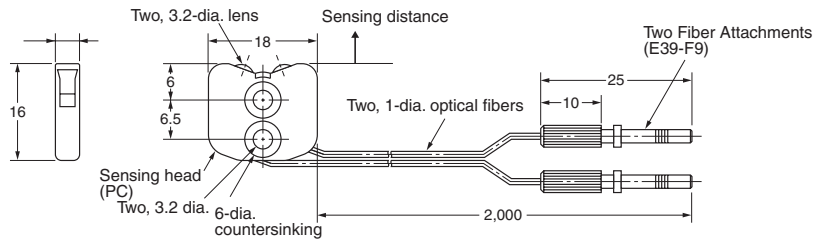

**E32-L25** (Free-cut)

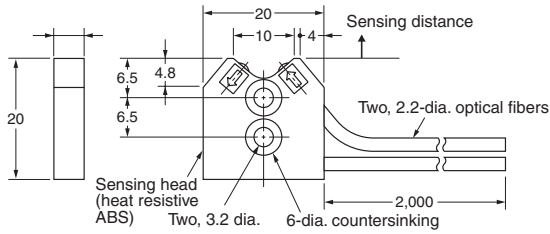

**E32-L25A** (Free-cut)

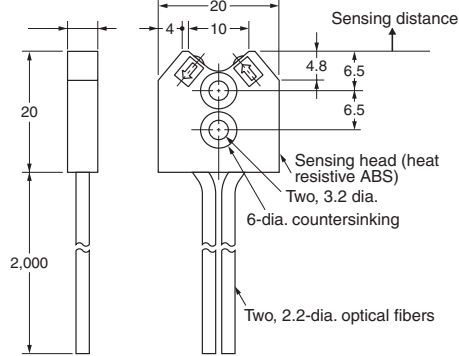

**Note:** The fiber for the emitter is identified by a white line.

**Note:** The fiber for the emitter is identified by a white line.

**E32-D16** (Free-cut)

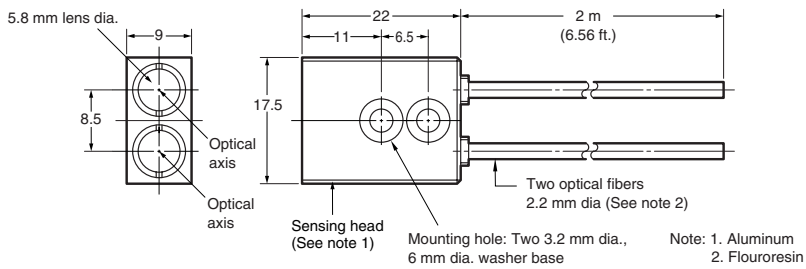

**E32-D11U** (Free-cut)

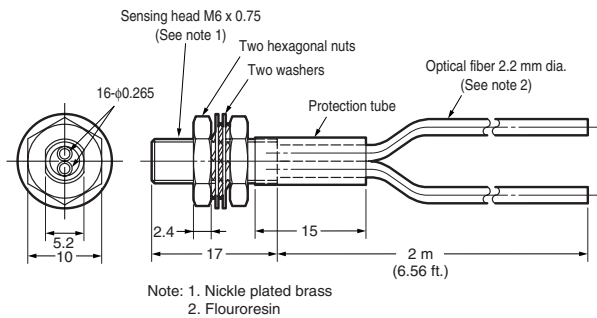



**E32-D81R**  
**E32-D81R-S**

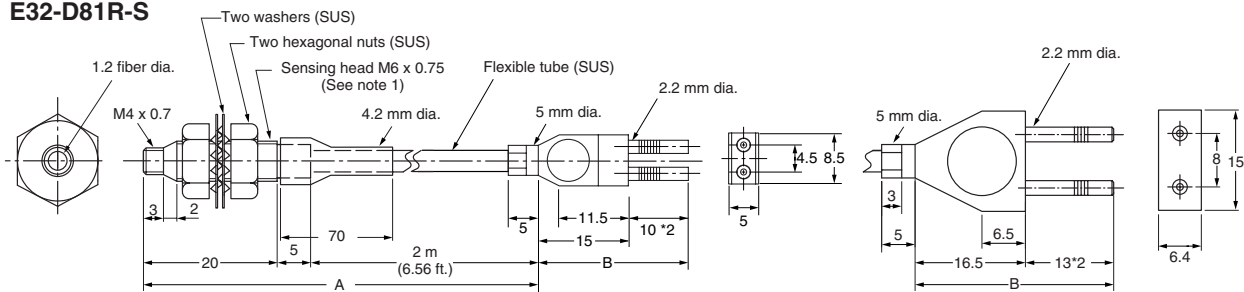

Note: 1. Nickel-plated brass.  
2. Section "A" can resist temperatures to 200°C; section "B" can resist temperatures to 110°C.

**E32-L16** (Free-cut)

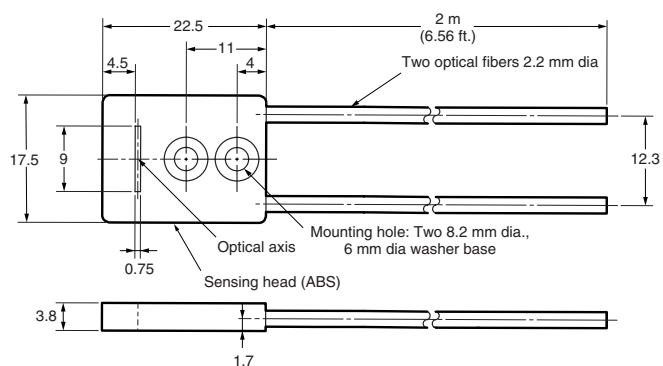

**E32-L66**

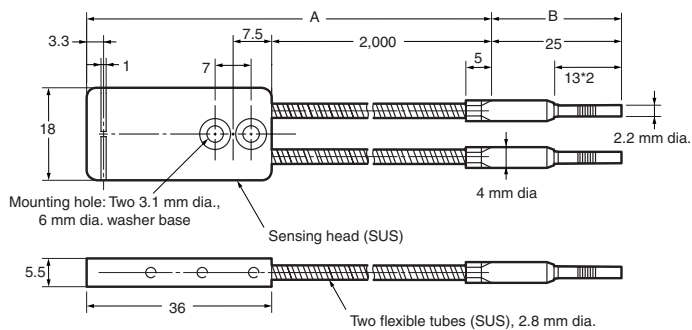

Note: Section "A" resists temperatures to 300°C; section "B" resists temperatures to 110°C

**E32-L24S** (Free-cut)

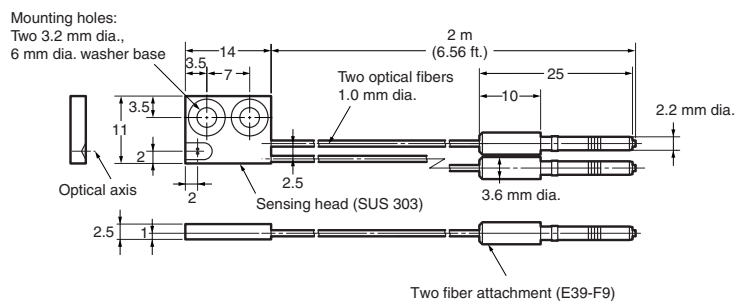

Unit:mm (inch)

**E32-A01** (Free-cut)

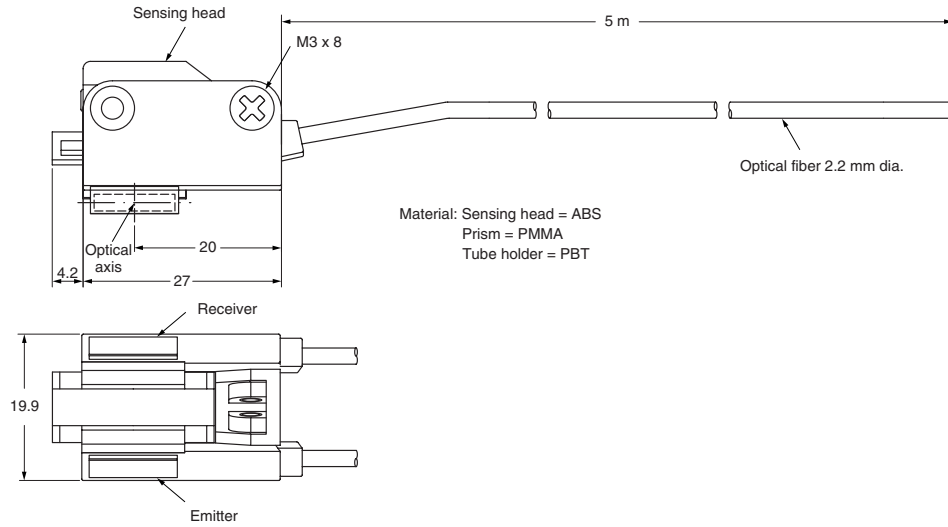
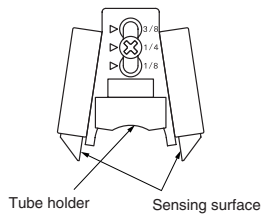

**E32-A02** (Free-cut)

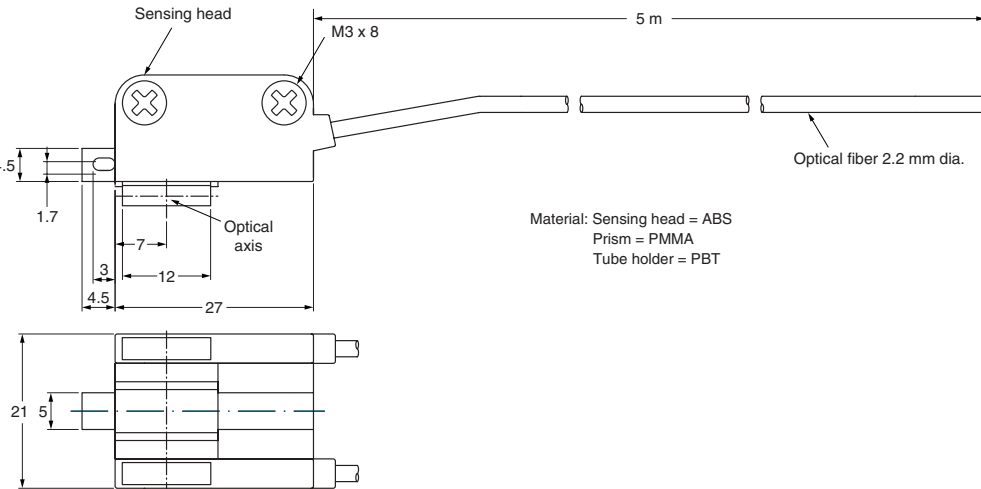
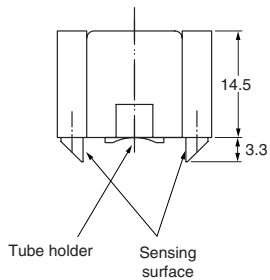

**E32-D36F** (Free-cut)

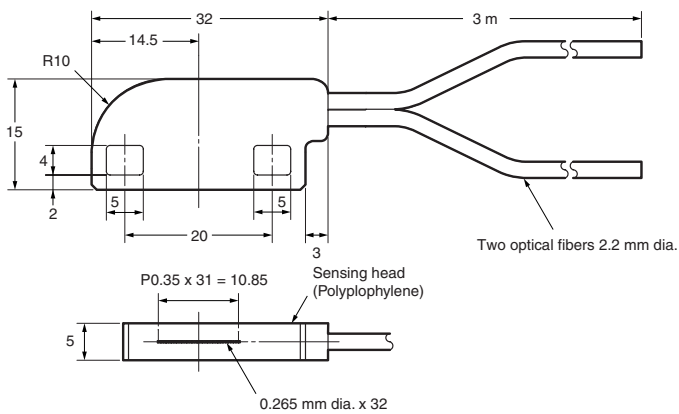

Fiber clad layout is as follows:

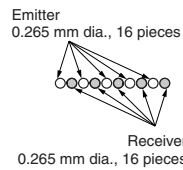

**E32-A03** (Free-cut)

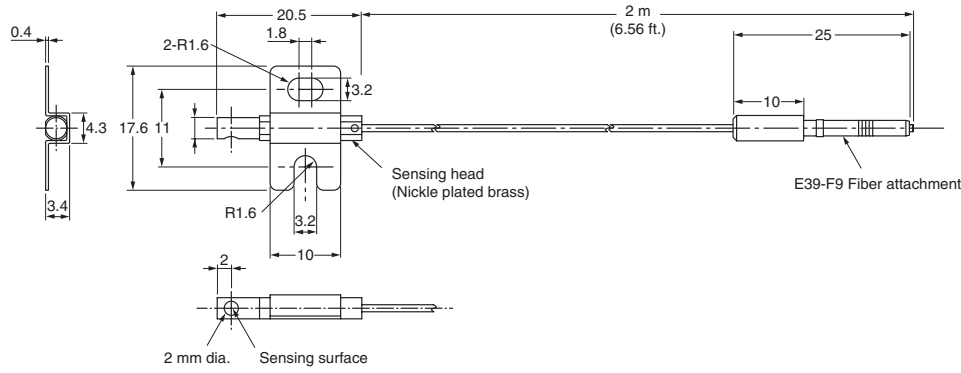

**E32-A04** (Free-cut)

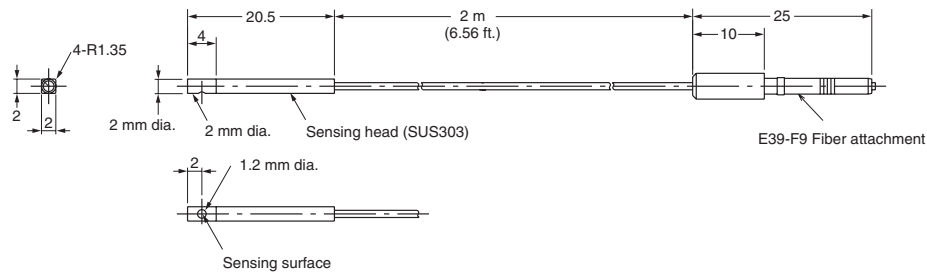

■ **Accessories (Order Separately)**

**Reflectors**

**Reflector E39-R1**



Material:  
Reflective surface:  
acrylic  
Back: ABS

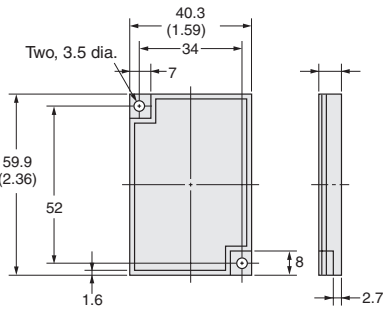

**Reflector (Miniature) E39-R3**



Material:  
Reflective surface:  
acrylic  
Back: ABS

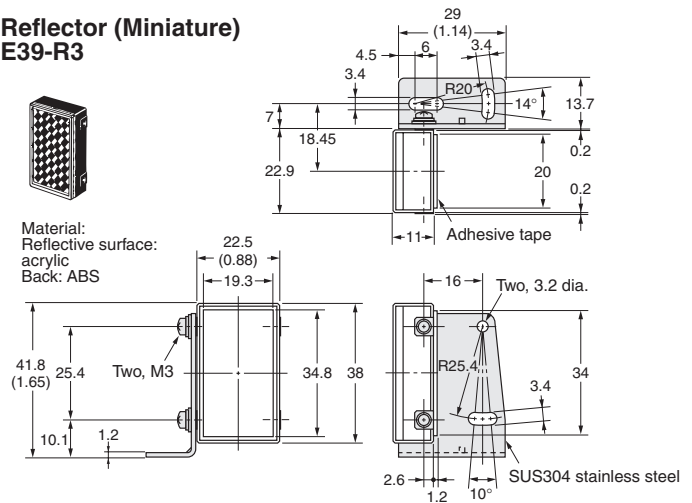

Unit: mm (inch)

**E39-L4**

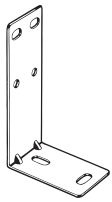

Material: iron

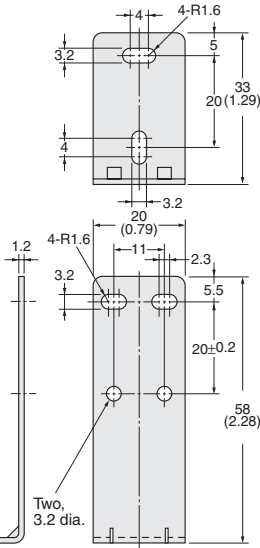

**E39-L94**

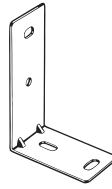

Material: iron

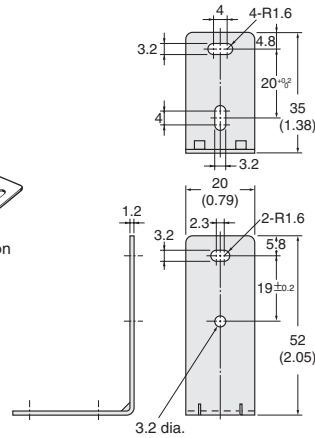

**Lens Units**

**E39-F1  
Long Distance Lens Unit**



Material:  
Tube: Brass  
Lens: Optical glass

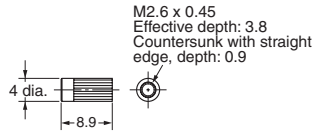

**Note:** One set includes two units.

**E39-F2  
Side-view Unit**



Material:  
Tube: Brass  
Lens: Optical glass

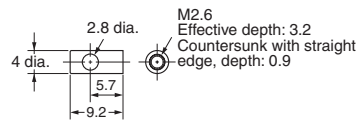

**Note:** One set includes two units.

**E39-F3  
Lens-equipped Reflective Unit**

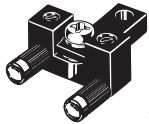

Material:  
Tube: Brass  
Base: Aluminum

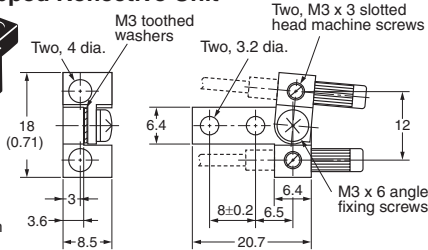

**Note:** Fix the fiber head using the slotted head machine screw. Do not insert the E39-F1 Lens.

**E39-F5  
Side-view Reflective Unit**

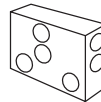

Material:  
Base: Brass  
Reflector: Stainless steel

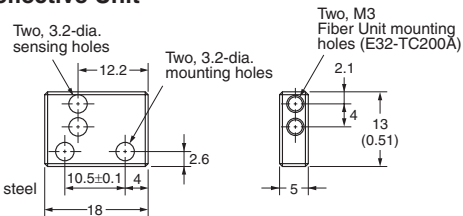

**Note:** Only E32-TC200A can be mounted. When mounting, remove all of the accompanying screws first and then screw the E32-TC200A into the E39-F5 until the stopper comes into contact.

**E39-F3A  
Small Spot Lens Unit**

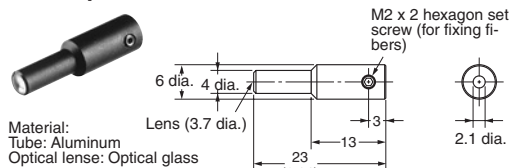

Material: Aluminum  
Tube: Aluminum  
Optical lens: Optical glass

**Note:** E39-F3A is a Lens Unit for the E32-D32 and E32-C42.

**E39-F3A-5  
Small Spot Lens Unit**

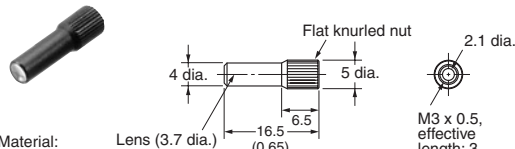

Material: Aluminum  
Tube: Aluminum  
Optical lens: Optical glass

**Note:** E39-F3A-5 is a Lens Unit for the E32-C31 and E32-C41.

**E39-F3B  
Small Spot Lens Unit**

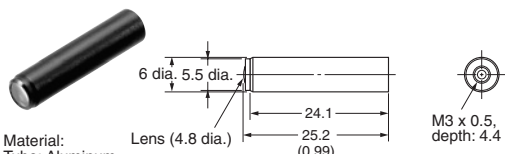

Material: Aluminum  
Tube: Aluminum  
Optical lens: Optical glass

**Note:** E39-F3B is a Lens Unit for the E32-C31 and E32-C41.

**E39-F3C  
Small Spot Lens Unit**

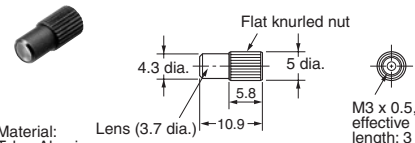

Material: Aluminum  
Tube: Aluminum  
Optical lens: Optical glass

**Note:** E39-F3C is a Lens Unit for the E32-C31 and E32-C41.

**E39-F32A, E39-F32A5  
E39-F32B, E39-F32B5**

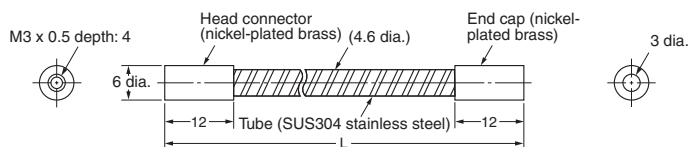

**Note:** 1. L is as follows:  
E39-F32A and E39-F32B: 1m (3.28 ft)  
E39-F32A5, E39-F32B5: .5m (1.64 ft)  
2. A pair of E39-F32A(5)'s is sold as E39-F32B(5).

**E39-F32C, E39-F32C5**

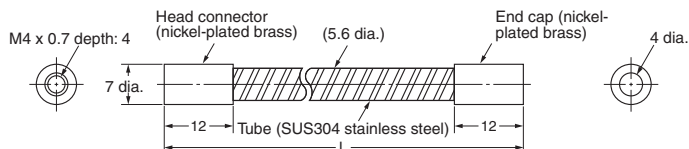
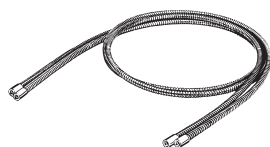

**Note:** L is as follows:  
E39-F32C: 1m (3.28 ft)  
E39-F32C5: .5m (1.64 ft)

**E39-F32D, E39-F32D5**

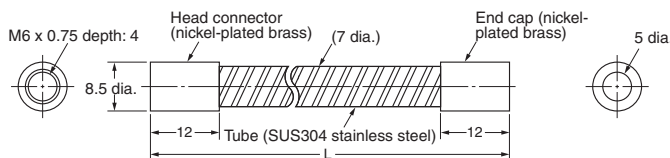
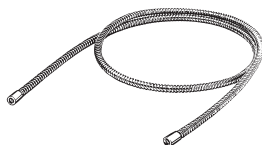

**Note:** L is as follows:  
E39-F32D: 1m (3.28 ft)  
E39-F32D5: .5m (1.64 ft)

Unit: mm (inch)

## Other Accessories

### E39-F4 Fiber Cutter

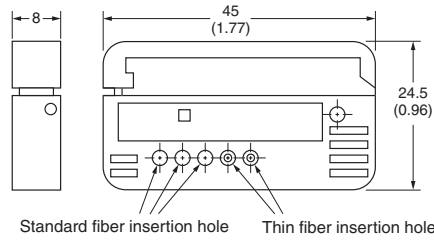
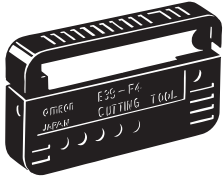

### E39-F9 Attachment for Thin Fiber

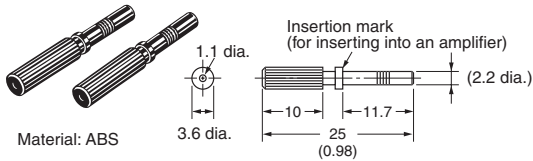

Material: ABS

**Note:** One set includes two units. Included with Thin Fiber Unit.

### E39-F10 Fiber Connector

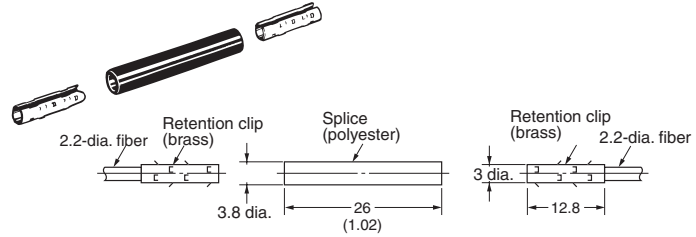

### E39-F11 Sleeve Bender

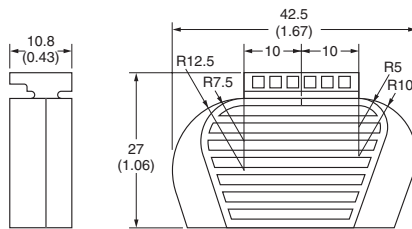

### E39-K2 Protective Attachment



Material: ABS

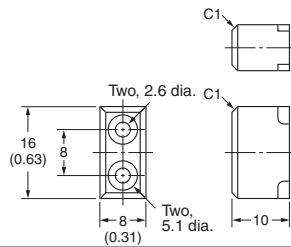

### Application Example

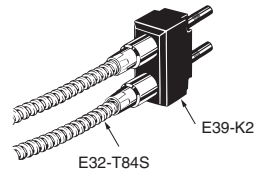



# Terms and Conditions

## WARRANTY, LIMITATIONS OF LIABILITY

**WARRANTY** OMRON's exclusive warranty is that the products are free from defects in materials and workmanship for a period of three years (or other period if specified) from date of sale by OMRON.

OMRON MAKES NO WARRANTY OR REPRESENTATION, EXPRESS OR IMPLIED, REGARDING NON-INFRINGEMENT, MERCHANTABILITY OR FITNESS FOR PARTICULAR PURPOSE OF THE PRODUCTS. ANY BUYER OR USER ACKNOWLEDGES THAT IT ALONE HAS DETERMINED THAT THE PRODUCTS WILL SUITABLY MEET THE REQUIREMENTS OF THEIR INTENDED USE. OMRON DISCLAIMS ALL OTHER WARRANTIES, EXPRESS OR IMPLIED.

**LIMITATIONS OF LIABILITY** OMRON SHALL NOT BE RESPONSIBLE FOR SPECIAL, INDIRECT OR CONSEQUENTIAL DAMAGES, LOSS OF PROFITS OR COMMERCIAL LOSS IN ANY WAY CONNECTED WITH THE PRODUCTS, WHETHER SUCH CLAIM IS BASED ON CONTRACT, WARRANTY, NEGLIGENCE OR STRICT LIABILITY.

In no event shall responsibility of OMRON for any act exceed the individual price of the product on which liability is asserted.

IN NO EVENT SHALL OMRON BE RESPONSIBLE FOR WARRANTY, REPAIR OR OTHER CLAIMS REGARDING THE PRODUCTS UNLESS OMRON'S ANALYSIS CONFIRMS THAT THE PRODUCTS WERE PROPERLY HANDLED, STORED, INSTALLED AND MAINTAINED AND NOT SUBJECT TO CONTAMINATION, ABUSE, MISUSE, OR INAPPROPRIATE MODIFICATION OR REPAIR.

## APPLICATION CONSIDERATIONS

**SUITABILITY FOR USE** OMRON shall not be responsible for conformity with any standards, codes or regulations which apply to the combination of the product in the customer's application or use of the product.

At the customer's request, OMRON will provide applicable third party certification documents identifying ratings and limitations of use which apply to the product. This information by itself is not sufficient for a complete determination of the suitability of the product in combination with the end product, machine, system, or other application or use.

The following are some examples of applications for which particular attention must be given. This is not intended to be an exhaustive list

of all possible uses of this product, nor is it intended to imply that the uses listed may be suitable for this product:

- Outdoor use, uses involving potential chemical contamination or electrical interference, or conditions or uses not described in this catalog.
- Nuclear energy control systems, combustion systems, railroad systems, aviation systems, medical equipment, amusement machines, vehicles, safety equipment, and installations subject to separate industry or government regulations.
- Systems, machines and equipment that could present a risk to life or property.

Please know and observe all prohibitions of use applicable to this product.

NEVER USE THE PRODUCT FOR AN APPLICATION INVOLVING SERIOUS RISK TO LIFE OR PROPERTY WITHOUT ENSURING THAT THE SYSTEM AS A WHOLE HAS BEEN DESIGNED TO ADDRESS THE RISKS, AND THAT THE OMRON PRODUCT IS PROPERLY RATED AND INSTALLED FOR THE INTENDED USE WITHIN THE OVERALL EQUIPMENT OR SYSTEM.

**PROGRAMMABLE PRODUCTS** OMRON shall not be responsible for the user's programming of a programmable product, or any consequence thereof.

## DISCLAIMERS

**PERFORMANCE DATA** Performance data given in this catalog is provided as a guide for the user in determining suitability and does not constitute a warranty. It may represent the result of OMRON's test conditions, and the user must correlate it to actual application requirements. Actual performance is subject to the OMRON Warranty and Limitations of Liability.

**CHANGE IN SPECIFICATIONS** Product specifications and accessories may be changed at any time based on improvements and other reasons. It is our practice to change part numbers when published ratings or features are changed, or when significant construction changes are made. However, some specifications of the product may be changed without any notice. When in doubt, special part numbers may be assigned to fix or establish key specifications for your application. Please consult with your OMRON representative at any time to confirm actual specifications of purchased product.

**ERRORS AND OMISSIONS** The information in this catalog has been carefully checked and is believed to be accurate; however, no responsibility is assumed for clerical, typographical or proofreading errors, or omissions.

Complete terms and conditions for product use are on Omron's website at [www.omron.com/oei](http://www.omron.com/oei) -- under the "About Us" tab, in the Legal Matters section.

ALL DIMENSIONS SHOWN ARE IN MILLIMETERS. To convert millimeters into inches, divide by 25.4

# OMRON®

## OMRON ELECTRONICS LLC

One Commerce Drive  
Schaumburg, IL 60173

**847-843-7900**

For US technical support or other inquiries:

**800-556-6766**

## OMRON CANADA, INC.

885 Milner Avenue  
Toronto, Ontario M1B 5V8

**416-286-6465**

## OMRON ON-LINE

Global - <http://www.omron.com>  
USA - <http://www.omron.com/oei>  
Canada - <http://www.omron.ca>