

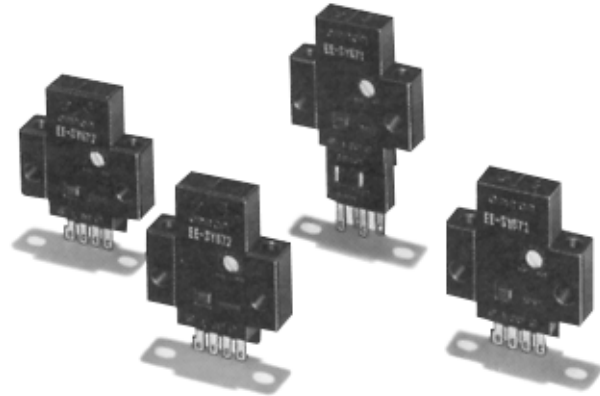

## EE-SY671/672

### Reflective Photomicrosensor with Sensitivity Adjuster

- Easy adjustment with a built-in sensitivity adjuster
- Models with the sensing window located on the top or side of the body
- Light-ON and Dark-ON selectable (Light-ON when the L terminal and the positive terminal are short-circuited)
- Easy optical axis monitoring with an operation indicator
- Compact photomicrosensor with a built-in amplifier and special IC makes it possible to directly switch currents up to 100 mA
- Wide operating voltage range (5 to 24 VDC) makes smooth connection possible with a TTLs, relays, and programmable controllers (PLCs)
- Convert to PNP output with EE-2002 conversion connector



### Ordering Information

Appearance	Sensing method	Sensing distance	Output configuration	Weight	Part number
	Reflective	1 to 5 mm (white paper with reflection factor of 90%)	Light-ON/Dark-ON*	Approx. 3.5 g	EE-SY671
					EE-SY672

\*The Light-ON/Dark-ON models can be used as Light-ON models when the L terminal and positive (+) terminal are connected. To use them as Dark-ON models do not connect these terminals.

# Specifications

## RATINGS

Item		EE-SY671	EE-SY672
Supply voltage		5 to 24 VDC $\pm 10\%$ , ripple (p-p): 10% max.	
Current consumption		40 mA max.	
Sensing distance		5 mm (white paper with reflection factor of 90%)	
Standard reference object		Transparent, opaque	
Differential distance		0.5 mm (with a sensing distance of 3 mm, horizontally)	
Control output		At 5 to 24 VDC: 100-mA load current ( $I_C$ ) with a residual voltage of 0.8 V max. When driving TTL: 40-mA load current ( $I_C$ ) with a residual voltage of 0.4 V max.	
Output configuration	Transistor on output stage without detecting object	ON (OFF if set to Light-ON)	
	Transistor on output stage with detecting object	OFF	
Indicator*	Without detecting object	OFF	
	With detecting object	ON	
Response frequency**		50 Hz max. (500 Hz typ.)	
Connecting method		EE-1001/1006 Connectors; soldering terminals	
Light source		GaAs infrared LED with a peak wavelength of 940 nm	
Receiver		Si photo-transistor with a sensing wavelength of 850 nm max.	

\*The indicator is a GaP red LED (peak emission wavelength: 690 nm).

\*\*The response frequency was measured by detecting the following Disks rotating.

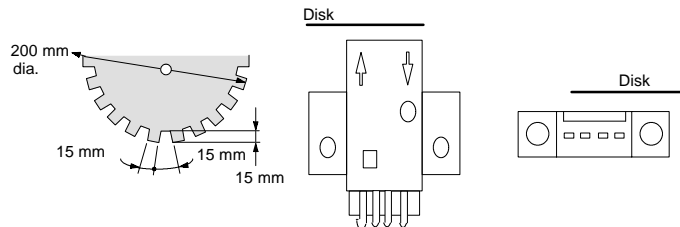

## CHARACTERISTICS

Ambient illumination*		Sensing face: fluorescent light: 1,500 $\ell$ x max.
Enclosure ratings		IP50
Ambient temperature	Operating	-10°C to 55°C (14°F to 131°F)
	Storage	-25°C to 80°C (-13°F to 176°F)
Ambient humidity	Operating	45% to 85%
	Storage	35% to 95%
Vibration resistance		Destruction: 20 to 2,000 Hz, 1.5-mm double amplitude for 2 hrs each in X, Y, and Z directions
Shock resistance		Destruction: 500 m/s <sup>2</sup> (approx. 50G) for 3 times each in X, Y, and Z directions
Cable length		2 m max. (0.3 mm <sup>2</sup> min.)

\*The ambient luminance is measured on the surface of the receiver.

\*\*This conforms to MIL-STD-750-2031-1.

# Engineering Data

## OPERATING RANGE (TYPICAL)

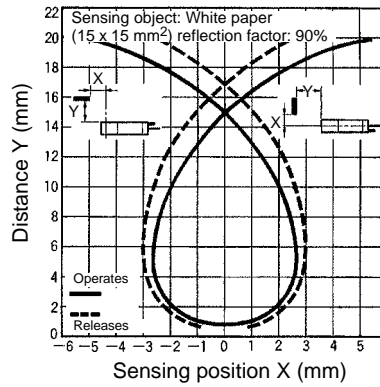
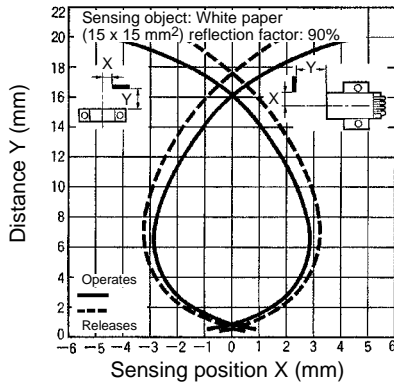

## SENSING DISTANCE VS. OBJECT AREA (TYPICAL)

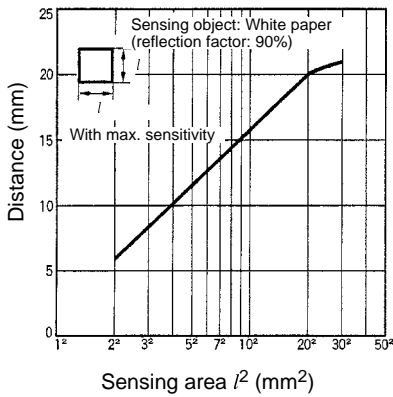

## SENSING DISTANCE VS. SENSITIVITY VOLUME CHARACTERISTICS (TYPICAL)

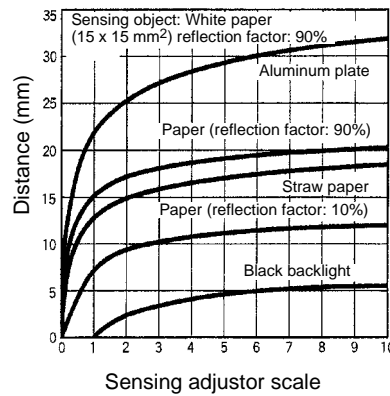

# Operation

## INTERNAL/EXTERNAL OUTPUT CIRCUIT DIAGRAM

### Light-ON/Dark-ON

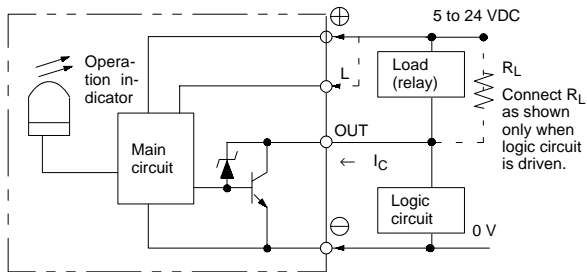

■ TIMING CHART

Light-ON

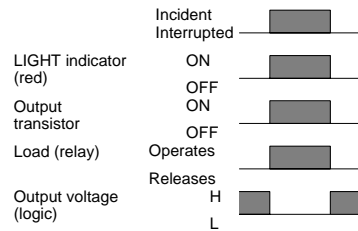

Dark-ON

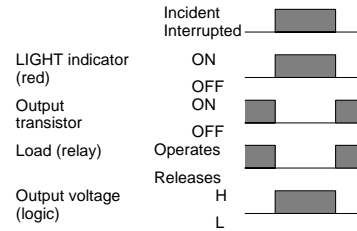

Dimensions

Unit: mm (inch)

■ EE-SY671

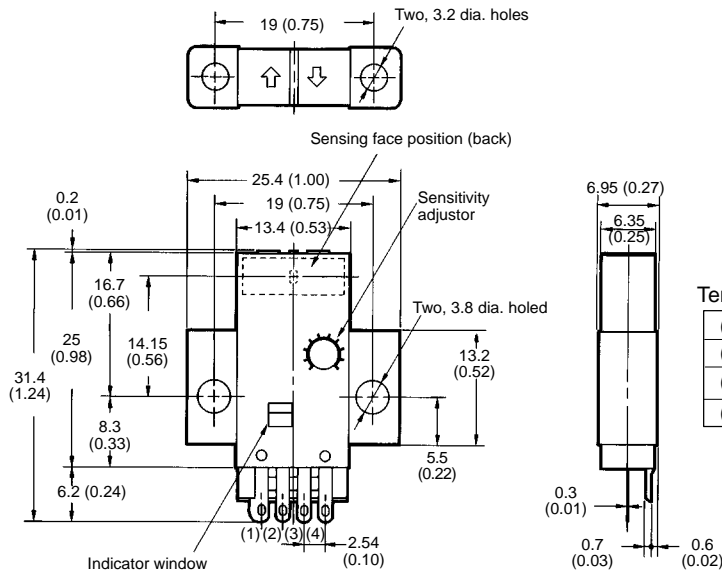
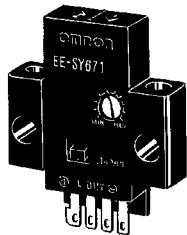

Terminal Arrangement

(1)	⊕	V <sub>CC</sub>
(2)	L	L
(3)	OUT	OUTPUT
(4)	⊖	GND (0 V)

EE-SY672

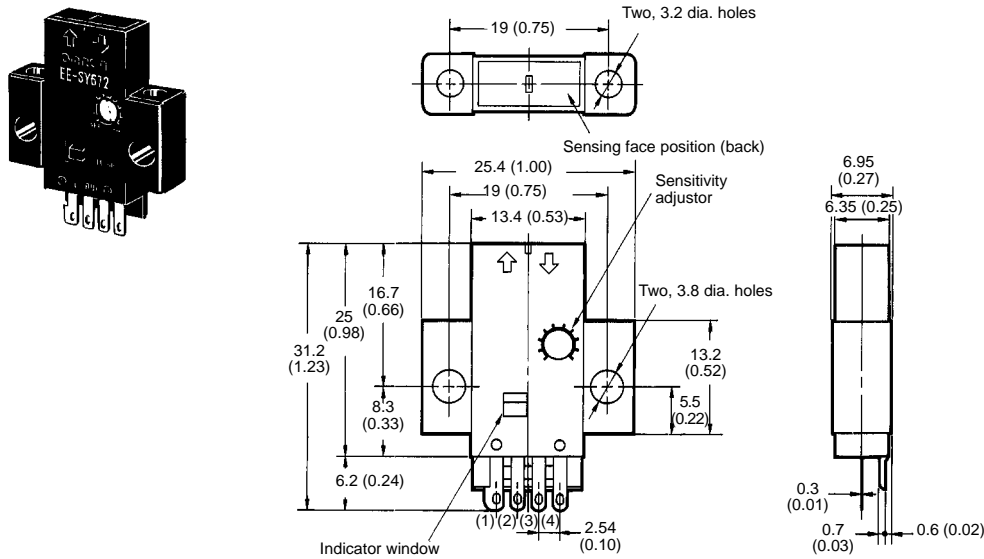

EE-1001 CONNECTOR

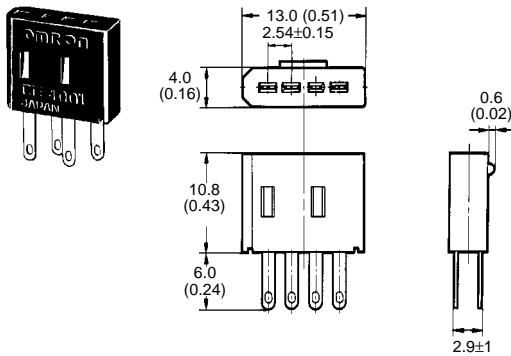

EE-SY671 + EE-1001

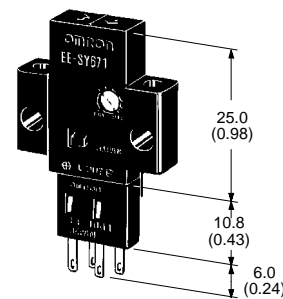

EE-1006 CONNECTOR WITH CABLE

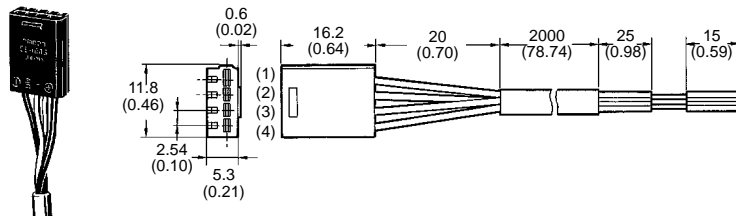

Terminal Arrangement

(1)	Brown (Red)	⊕	V <sub>CC</sub>
(2)	Pink (Yellow)	L	L
(3)	Black (White)	OUT	OUTPUT
(4)	Blue (Black)	⊖	GND (0 V)

Note: Older standard colors are shown in parentheses. Connector comes with a 2-m attached cable.

## ■ EE-1006A CONNECTOR HOLDER

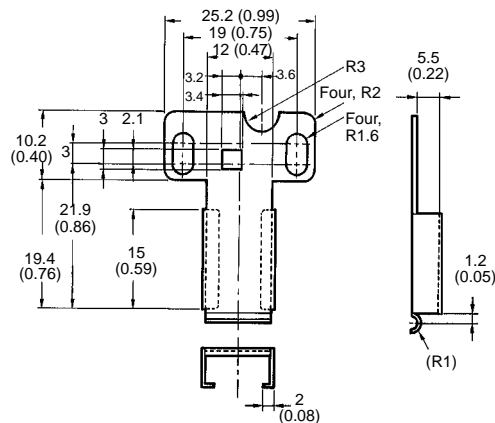
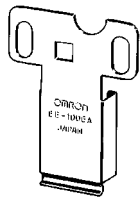

## Precautions

Refer to the Technical Information Section for general precautions.

The sensing window is made of a polycarbonate resin which withstands alcohol, chloride solvents, and strong acids but is soluble in strong alkali, aromatic hydrocarbons, and aliphatic hydrocarbonate chloride solvents.

The casing material uses a PBT resin, which is soluble in strong acid or alkali solvents.

## ■ SENSITIVITY ADJUSTMENT

Use the special screwdriver (included with sensor) for sensitivity adjustment.

The sensitivity adjuster can be turned clockwise and counterclockwise endlessly. This means when the sensitivity of the photomicrosensor is maximum, further turning the adjuster clockwise will abruptly drop the sensitivity to minimum. When using the photomicrosensor with its maximum sensitivity, pay due attention to the adjustment of the sensitivity.

The shaft of the sensitivity adjuster is charged. Connect a DC power supply incorporating an insulated transformer to the photomicrosensor. Do not connect a DC power supply incorporating an autotransformer or the user may receive an electric shock when adjusting the sensitivity.

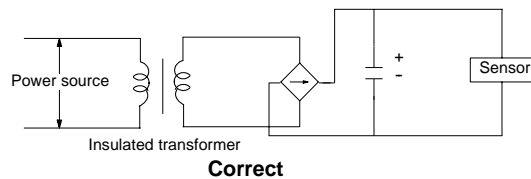
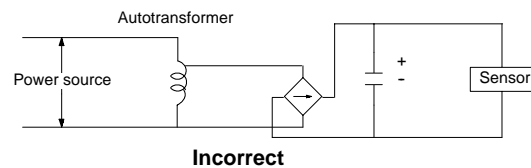

### Sensitivity Adjustment with Background Object

- Set the sensitivity of the photomicrosensor to minimum, place the sensing object at the sensing position, turn the sensitivity adjuster clockwise slowly until the operation indicator is lit (point A).
- Remove the sensing object. When the operation indicator is OFF, further turn the sensitivity adjuster clockwise slowly until the operation indicator is lit again (point B). The operation indicator will not light again if the background object does not reflect light, in which case refer to Sensitivity Adjustment with No Background Object.
- Set the sensitivity adjuster at the center (point C) between points A and B. Points A and B will be very close if the sensor is influenced by excessive light reflected by the background object. If this is true, take the following preventative measures:
  - Make a large enough distance between the sensor and the background object.
  - Cover the surface of the background object with a material with a small reflection factor, such as a black sponge.

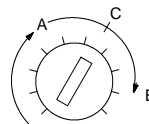

- After setting the sensitivity adjuster to point C, assure that the operation indicator is on when the target object is placed in the sensing position. It should be off when the target is removed.

**Sensitivity Adjustment with No Background Object**

1. Set the sensitivity of the photomicrosensor to minimum; place the sensing object at the sensing position; turn the sensitivity adjuster clockwise slowly until the operation indicator is lit (point A).
2. Set the sensitivity adjuster at the center (point C) between points A and B (the point where the sensitivity is maximum).
3. After setting the sensitivity adjuster to point C, check to ensure that the operation indicator is not on when the target object has been removed.

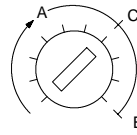

**NOTE: DIMENSIONS SHOWN ARE IN MILLIMETERS. To convert millimeters to inches divide by 25.4.**

**OMRON**<sup>®</sup>**OMRON ELECTRONICS, INC.**One East Commerce Drive  
Schaumburg, IL 60173**1-800-55-OMRON****OMRON CANADA, INC.**885 Milner Avenue  
Scarborough, Ontario M1B 5V8**416-286-6465**