

Digital Fiber Sensors

E3X-DA-S

High accuracy Digital Fiber Amplifier

- The industry's first Power Tuning function in a digital amplifier.
- High resolution of 4000 digits for long sensing distances and accurate settings
- Short response time of only 50 μ s (turn on) for fast sensing processes
- Mutual interference suppression for simultaneous sensor operations
- Two large easy to read displays
- Stable long term performance due to OMRON's APC function.
- APC (Auto Power Control)
- Environmentally friendly design.

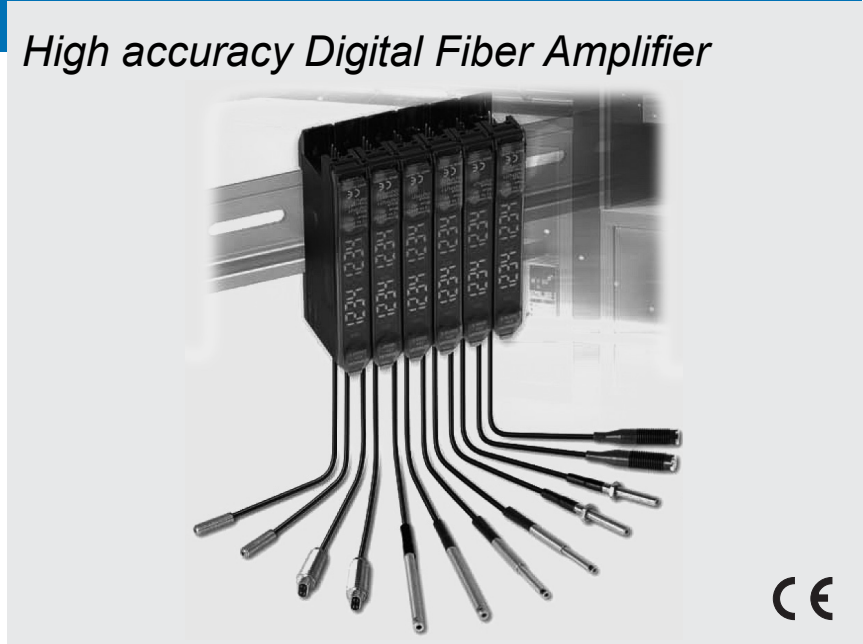

Features

Industry's first power tuning function in a digital sensor.

No complicated mode settings.

Troublesome power adjustments have been eliminated, so it isn't necessary to select from power mode settings, such as long-distance mode, standard mode, and short-distance mode. When the MODE Key is pressed once, the power tuning function shifts the power level so that the present incident level is set to the ideal level (2000 on the digital display.)

Earlier Method

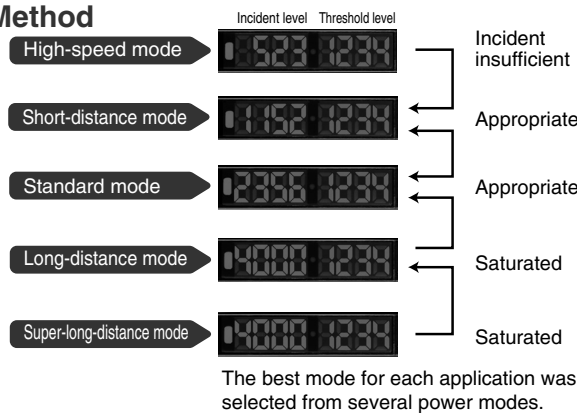

New Method

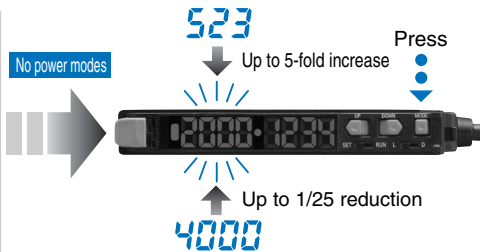

The Sensor can be used immediately without setting the mode. If the incident light level is too high or too low, just press the Mode key to achieve the optimum status.

Insufficient light or saturation at short distances can be corrected.

The power tuning range is extended to the allowable limits to eliminate problems such as insufficient light or detection failures due to saturation. If the installation distance is too short, the incident light may saturate (i.e., to a digital incident level of 4,000), preventing detection. The power can be tuned down to 1/25th of the default setting for stable detection even at close range.

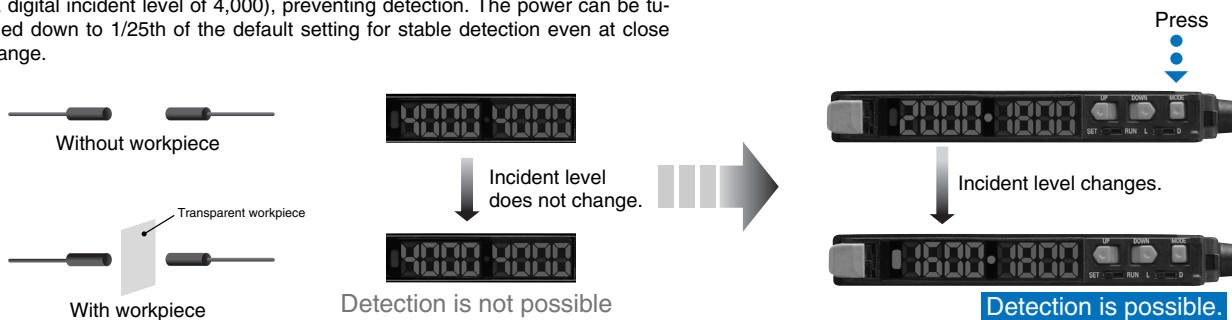

Variations between different Sensors can be eliminated.

Threshold levels had to be set and maintained separately for individual Sensors due to variations in the digital light levels measured by each Sensor. With power tuning, the incident level can be fine-tuned so the same threshold level can be set for each Sensor in an application. Maintenance is also simplified because it is easier to recognize measurement levels that have shifted during operation.

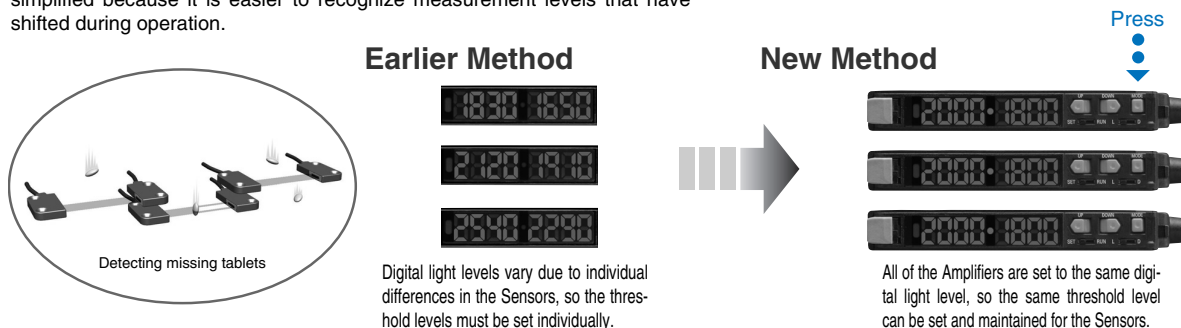

Large, easy-to-read displays: Clear even from a distance

The displays are large and easy-to-read, despite the small case.

Settings can be made more simply and confidently with two digital displays. For example, the threshold value can be changed while reading the incident level or a setting can be changed while confirming the setting's function item number.

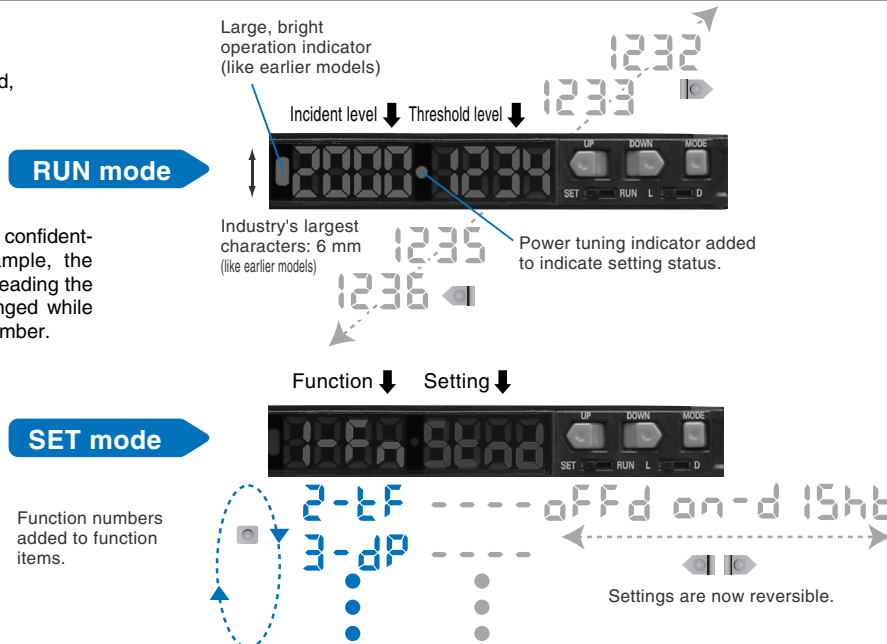

Stable, long-term performance with OMRON's APC function

OMRON provides the industry's most stable long-term detection Highest Level of Stability
by using new 4-element LEDs and an APC (Auto Power Control) circuit.

In addition to our unique APC circuit used in the E3X-DA-N Amplifiers to compensate for the deterioration of the LED, the E3X-DA-S uses 4-element LEDs to counteract the deterioration of the light-emitting elements over time and achieve the industry's most stable long-term detection performance. Furthermore, the circuit is designed with excess light capacity, so the Sensors can be used with high stability regardless of whether the APC circuit is ON or OFF.

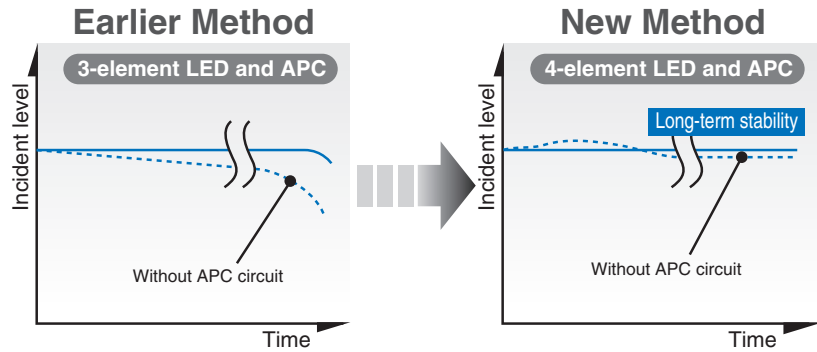

E3X-DA-S

Compensate for the effects of contaminants and temperature variation with differential operation mode. (Advanced Models)

This operation mode uses a special OMRON algorithm to compensate for slight light level changes due to dirt or temperature variations and detect only the light level changes due to the workpiece.

Slight light level changes can be detected with stability and precision, eliminating the need for time-consuming manual adjustments for light level changes.

With the Twin-output Amplifiers, output 2 can function as an alarm output (light level operation) to indicate when the light level has changed due to dirt or other causes. Patent Pending

Light Level Operation (Normal Operation)

Judges light level changes by comparing the incident level and threshold level.

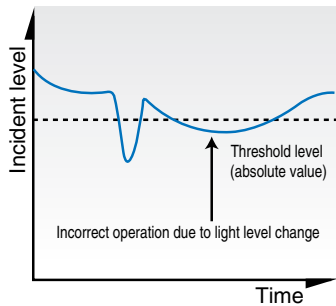

The light level varies due to dirt, temperature variations, or other environmental factors.

Incorrect operation

Differential Operation

Judges light level changes by comparing the incident level to a time-averaged incident level.

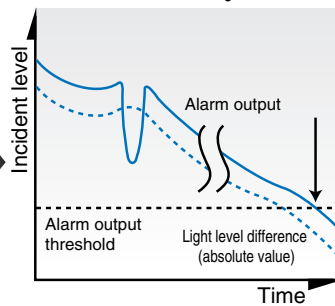

Detecting differences in the light level enables setting more subtle light level differences.

Minute changes are detected reliably.

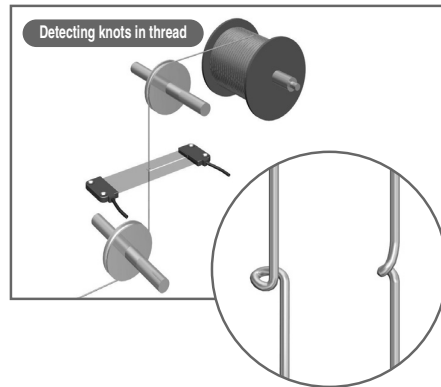
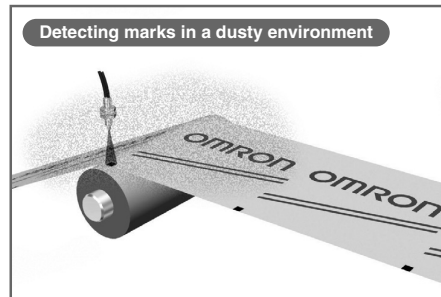

The E3X-DA-S uses OMRON's own simplified wiring connectors that were introduced with the E3X-DA-N.

Patent Pending
Japan patent number 3266198

In Amplifiers with Connectors, the power supply is distributed to slave connectors through a single master connector. This design has three major advantages.

1. Wiring time is significantly reduced.
2. Relay connectors are unnecessary, so wiring takes up less space.
3. Storage and maintenance are simpler because it isn't necessary to distinguish between master connector and slave connectors on the Amplifier.

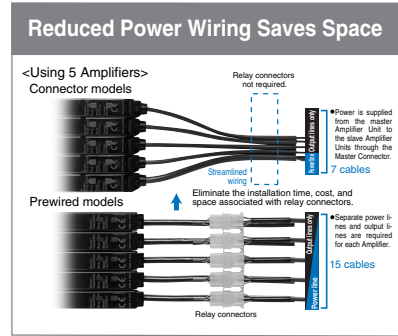
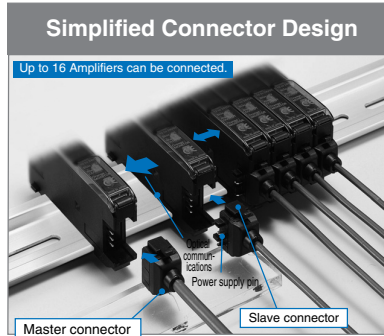

Optical communications prevents mutual interference.

Mutual interference is prevented with optical communications, so up to 10 Amplifiers can be mounted together.

(The number of Amplifiers depends on the operating conditions.)

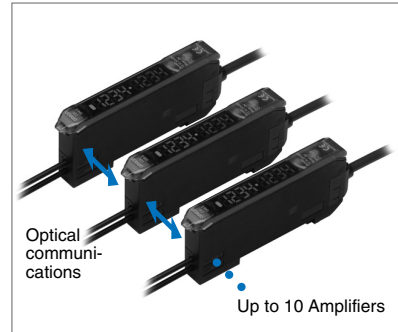
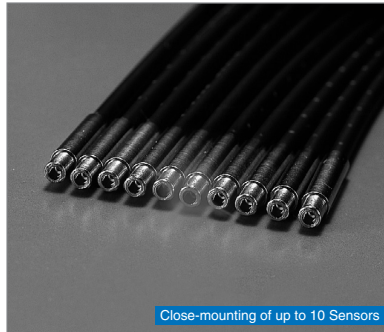

Can also be used with Photoelectric Sensors with Separate Digital Amplifiers.



E3C-LDA
Photoelectric Sensor with Separate Digital Amplifier

E3X-MC-S
Mobile Console

Group Power Tuning

With the group power tuning function, power tuning is possible for multiple Sensors at the same time.



Group Power Tuning



Easily set
multiple Sensors.

Retains all of the Previous Advantages of the Mobile Console.

New and Improved
Fiber Sensor and
Mobile Console.

Settings, teaching, and fine-tuning can be performed at the fiber tip.

The Mobile Console can be used for settings and teaching at the tip of the fiber. Difficult adjustments can be made while checking the workpiece position. Even if the Amplifier and Sensor head are separated during operation, it is still possible to flash the Sensor head and display the amplifier channels.

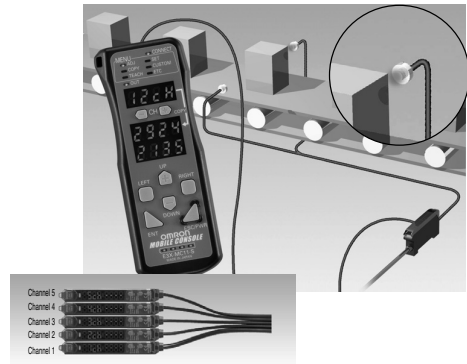

With Group Teaching, Teach Multiple Amplifiers Simultaneously.

The tedious teaching that had to be performed separately for each Amplifier can now be performed for several Amplifiers at once using the Mobile Console.

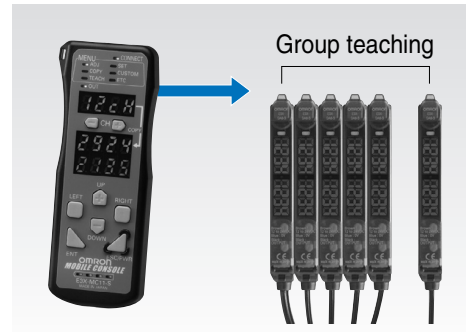

Copying Settings to Other Groups

The settings for a group of Amplifiers on one machine can be copied to a group of Amplifiers on another machine. (The settings can also be copied to and from banks.)

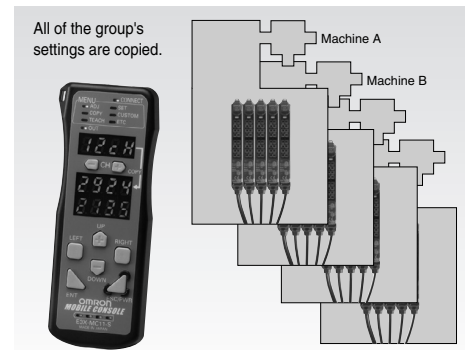

Environmentally friendly features are essential in truly high-performance products.

Materials containing lead have been completely eliminated. **First in the industry**

The Fiber Sensor is the first in the industry to use environmentally friendly lead-free solder.



Ordering Information

Amplifier Units



Amplifier Units with Cables

Item	Appearance	Functions	Model		
			NPN output	PNP output	
Standard models		---	E3X-DA11-S	E3X-DA41-S	
Mark-detecting models		Green LED	---	E3X-DAG11-S	E3X-DAG41-S
		Blue LED	---	E3X-DAB11-S	E3X-DAB41-S
		Infrared LED	---	E3X-DAH11-S	E3X-DAH41-S
Advanced models		Twin-output models	Area output, self-diagnosis, differential operation	E3X-DA11TW-S	E3X-DA41TW-S
	External-input models	Remote setting, counter, differential operation	E3X-DA11RM-S	E3X-DA41RM-S	

Amplifier Units with Connectors

Item	Appearance	Functions	Model		
			NPN output	PNP output	
Standard models		---	E3X-DA6-S	E3X-DA8-S	
Mark-detecting models		Green LED	---	E3X-DAG6-S	E3X-DAG8-S
		Blue LED	---	E3X-DAB6-S	E3X-DAB8-S
Advanced models		Twin-output models	Area output, self-diagnosis, differential operation	E3X-DA6TW-S	E3X-DA8TW-S
		External-input models	Remote setting, counter, differential operation	E3X-DA6RM-S	E3X-DA8RM-S

Amplifier Unit Connectors (Order Separately)

Item	Appearance	Cable length	No. of conductors	Model
Master Connector		2 m	3	E3X-CN11
			4	E3X-CN21
Slave Connector			1	E3X-CN12
			2	E3X-CN22

Combining Amplifier Units and Connectors

Amplifier Units and Connectors are sold separately. Refer to the following tables when placing an order.

Amplifier Unit			Applicable Connector (Order Separately)	
Model	NPN output	PNP output	Master Connector	Slave Connector
Standard models	E3X-DA6-S	E3X-DA8-S	E3X-CN11 (3-wire)	E3X-CN12 (1-wire)
Mark-detecting models	E3X-DAG6-S	E3X-DAG8-S		
		E3X-DAB6-S	E3X-DAB8-S	E3X-CN21 (4-wire)
Advanced models	E3X-DA6TW-S	E3X-DA8TW-S		
		E3X-DA6RM-S	E3X-DA8RM-S	





When Using 5 Amplifier Units

Amplifier Units (5 Units)	+	1 Master Connector + 4 Slave Connectors
---------------------------	---	---

Further sensor connectors (pigtaills)

Item	Appearance	Description	Model
M8 Pigtail		4pole M8 connector, with Omron system connector, 30 cm total length	E3X-CN21-M3J-1 0.3M BY OMG
M12 Pigtail		4 pole M12 connector, with Omron system connector, 30 cm total length	E3X-CN21-M1J 0.3M

Mobile Console (Order Separately)

Appearance	Model	Remarks
	E3X-MC11-C1-SV2	Mobile Console for use of E3X-DA-S / MDA (not for E3X-DA-N)
	E3X-MC11-H1	Head - Optical interface
	E39-Z12-1	Communication cable (1,5 m)
	E3X-MC11-S-PS3 BY OMG	European AC/DC Adapter Primary: 100V-240V Secondary: 5V/2,4A ROHS, CE, IP40
	E3X-MC11-S-PS3-UK BY OMG	Primary UK adapter for E3X-MC11-S-PS3 BY OMG

Note: For ordering a European functional set of Mobile Console please order:
 1 x E3X-MC11-C1-SV2
 1 x E3X-MC11-H1
 1 x E39-Z12-1
 1 x E3X-MC11-S-PS3 BY OMG
 For use in UK pls. order the E3X-MC11-S-PS3-UK BY OMG adapter separately.

Accessories (Order Separately)

Mounting Bracket

Appearance	Model	Quantity
	E39-L143	1

End Plate

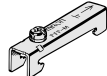
Appearance	Model	Quantity
	PFP-M	1

DeviceNet Communication unit

Type	Model
DeviceNet	E3X-DRT21-S

Wire-reducing Connector

Type	Model
Cordless Slave Connector	E3X-CN02

Specifications

Ratings/Characteristics

Amplifier Units

Amplifier Units with Cables

Model	Type		Standard models	Mark-detecting models				Advanced, twin-output models	Advanced, external-input models
	NPN output	PNP output	E3X-DA11-S	E3X-DAG11-S	E3X-DAB11-S	E3X-DAH11-S	E3X-DA11TW-S	E3X-DA11RM-S	
Item	NPN output	PNP output	E3X-DA41-S	E3X-DAG41-S	E3X-DAB41-S	E3X-DAH41-S	E3X-DA41TW-S	E3X-DA41RM-S	
Light source (wavelength)			Red LED (650 nm)	Green LED (525 nm)	Blue LED (470 nm)	Infrared LED	Red LED (650 nm)		
Supply voltage			12 to 24 VDC ±10%, ripple (p-p) 10% max.						
Power consumption			960 mW max. (current consumption: 40 mA max. at power supply voltage of 24 VDC)				1,080 mW max. (current consumption: 45 mA max. at power supply voltage of 24 VDC)		
Control output			Load power supply voltage: 26.4 VDC; NPN/PNP open collector; load current: 50 mA max.; residual voltage: 1 V max.						
Circuit protection			Reverse polarity for power supply connection, output short-circuit						
Re- sponse time	Super-high-speed mode	NPN	48 µs for operation and 50 µs for reset				80 µs for operation and reset respectively	48 µs for operation and 50 µs for reset ^{*1}	
		PNP	53 µs for operation and 55 µs for reset					53 µs for operation and 55 µs for reset ^{*1}	
	Standard mode		1 ms for operation and reset respectively						
	High-resolution mode		4 ms for operation and reset respectively						
Sensitivity setting			Teaching or manual method						

Model Item	Type	Standard models	Mark-detecting models			Advanced, twin-output models	Advanced, external-input models
	NPN output	E3X-DA11-S	E3X-DAG11-S	E3X-DAB11-S	E3X-DAH11-S	E3X-DA11TW-S	E3X-DA11RM-S
	PNP output	E3X-DA41-S	E3X-DAG41-S	E3X-DAB41-S	E3X-DAH41-S	E3X-DA41TW-S	E3X-DA41RM-S
Functions	Power tuning	Light emission power and reception gain, digital control method					
	Differential detection	---			Switchable between single edge and double edge detection mode Single edge: Can be set to 250 μs, 500 μs, 1 ms, 10 ms, or 100 ms. Double edge: Can be set to 500 μs, 1 ms, 2 ms, 20 ms, or 200 ms.		
	Timer function	Select from OFF-delay, ON-delay, or one-shot timer. 1 ms to 5 s (1 to 20 ms set in 1-ms increments, 20 to 200 ms set in 10-ms increments, 200 ms to 1 s set in 100-ms increments, and 1 to 5 s set in 1 s-increments)					
	Automatic power control (APC)	High-speed control method for emission current Control for providing constant LED output power					
	Zero-reset	Display can be reset to zero when required (negative values can be displayed).					
	Initial reset	Settings can be returned to defaults as required.					
	Mutual interference prevention	Possible for up to 10 Units *2, *3					
	Counter	---			Switchable between up counter and down counter. Set count: 0 to 9,999,999		
	I/O settings	---			Output setting (Select from channel 2 output, area output, or self-diagnosis.)		External input setting (Select from teaching, power tuning, zero reset, light OFF, or counter reset.)
Display	Operation indicator (orange), Power Tuning indicator (orange)			Operation indicator for channel 1 (orange), Operation indicator for channel 2 (orange)		Operation indicator (orange), Power Tuning indicator (orange)	
Digital display	Select from the following: Incident level + threshold, incident level percentage + threshold, incident light peak level + no incident light bottom level, minimum incident light peak level + maximum no incident light bottom level, long bar display, incident level + peak hold, incident level + channel					Select from same displays as given at the left or a counter display.	
Display orientation	Switching between normal/reversed display is possible.						
Ambient illumination (receiver side)	Incandescent lamp:10,000 lux max. Sunlight:20,000 lux max.						
Ambient temperature	Operating:Groups of 1 to 2 Amplifiers: -25° C to 55° C Groups of 3 to 10 Amplifiers: -25° C to 50° C Groups of 11 to 16 Amplifiers: -25° C to 45° C (with no icing or condensation) Storage: -30° C to 70° C (with no icing or condensation)						
Ambient humidity	Operating and storage: 35% to 85% (with no condensation)						
Insulation resistance	20 MΩ min. (at 500 VDC)						
Dielectric strength	1,000 VAC at 50/60 Hz for 1 minute						
Vibration resistance (destruction)	10 to 55 Hz with a 1.5-mm double amplitude for 2 hrs each in X, Y and Z directions						
Shock resistance (destruction)	500 m/s ² , for 3 times each in X, Y and Z directions						
Enclosure rating	IEC 60529 IP50 (with Protective Cover attached)						
Connection method	Prewired cable						
Weight (packed state)	Approx. 100 g						
Materials	Case	Polybutylene terephthalate (PBT)					
	Cover	Polycarbonate (PC)					
Accessories	Instruction sheet						

*1. When counter is enabled: 80 μs for operation and reset respectively.

*2. Communications are disabled if the detection mode is selected during super-high-speed mode, and the communications functions for mutual interference prevention and the Mobile Console will not function.

*3. Mutual interference prevention can be used for only up to 6 Units if power tuning is enabled.

Amplifier Units with Connectors

(Specifications different to those for Amplifier Units with cables)

Model Item	Type	Standard models	Mark-detecting models		Advanced, twin-output models	Advanced, external-input models
		NPN output	E3X-DA6-S	E3X-DAG6-S	E3X-DAB6-S	E3X-DA6TW-S
	PNP output	E3X-DA8-S	E3X-DAG8-S	E3X-DAB8-S	E3X-DA8TW-S	E3X-DA8RM-S
Connection method		Standard connector				
Weight (packed state)		Approx. 55 g				

Amplifier Unit Connectors

Item	E3X-CN11/21/22		E3X-CN12
Rated current	2.5 A		
Rated voltage	50 V		
Contact resistance	20 mΩ max. (20 mVDC max., 100 mA max.) (The figure is for connection to the Amplifier Unit and the adjacent Connector. It does not include the conductor resistance of the cable.)		
No. of insertions (destruction)	50 times (The figure for the number of insertions is for connection to the Amplifier Unit and the adjacent Connector.)		
Materials	Housing	Polybutylene terephthalate (PBT)	
	Contacts	Phosphor bronze/gold-plated nickel	
Weight (packed state)	Approx. 55 g		Approx. 25 g

Mobile Console

Item	E3X-MC11-S
Supply voltage	Charged with AC adapter
Connection method	Connected via adapter
Weight (packed state)	Approx. 580 g (Console only: 120 g)
Refer to <i>Operation Manual</i> provided with the Mobile Console for details.	

DeviceNet Communication unit

Item	E3X-DRT21-S	
Communications Method	DeviceNet communications	
Communications functions	Remote I/O Communications Slave function	Monitors ON/OFF output, status, incident light level (digital display data)
	Message Communications function	Sets parameters using Explicit messages
	Configurator	Edits slave device parameters, enables device monitor functions
Mobile Console connection	E3X-MC11-S-V2 can be connected	
Power supply	Supplied from the DeviceNet communications connector (power is also supplied to all connected Sensors through Wire-reducing Connectors)	
Maximum connectable Sensors	13 or 16 (depending on the operation mode)	
Connectable Sensors	E3X-DA-S Series or E3X-MDA Series Digital Fiber Sensor E3C-LDA Series Laser Photoelectric Sensor with Separate Digital Amplifier E2C-EDA High-resolution Digital Proximity Sensor with Separate Amplifier (use connector-type Amplifier Units and the E3X-CN02 Cordless Slave Connector)	
Power supply voltage	11 to 25 VDC	
Current consumption ^{*1}	70 mA max.	
Ambient operating temperature	-20 to 55°C	
Ambient operating humidity	35% to 85% (with no condensation)	
Storage temperature	-30 to 70°C	
Dimensions (mm)	30 x 34.6 x 71.3 (WxHxD)	
Weight (packed state)	Approx. 150 g	

*1. This does not include the current supplied to the Sensor.

Output Circuits

NPN Output

Model	Mode selector	Timing chart	Mode selector	Output circuit
E3X-DA11-S E3X-DA6-S E3X-DAG11-S E3X-DAG6-S E3X-DAB11-S E3X-DAB6-S	LIGHT ON (L/ON)	<p>Incident light</p> <p>No incident light</p> <p>Operation indicator (orange) ON OFF</p> <p>Output transistor ON OFF</p> <p>Load (relay) Operate Release (Between brown and black)</p>	Light ON	
	DARK ON (D/ON)	<p>Incident light</p> <p>No incident light</p> <p>Operation indicator (orange) ON OFF</p> <p>Output transistor ON OFF</p> <p>Load (relay) Operate Release (Between brown and black)</p>	Dark ON	
E3X-DA11TW-S E3X-DA6TW-S	LIGHT ON (L/ON)	<p>CH1/CH2 Incident light</p> <p>No incident light</p> <p>Operation indicator (orange) ON OFF</p> <p>Output transistor ON OFF</p> <p>Load (relay) Operate Release (Between brown and black)</p>	Light ON	
	DARK ON (D/ON)	<p>CH1/CH2 Incident light</p> <p>No incident light</p> <p>Operation indicator (orange) ON OFF</p> <p>Output transistor ON OFF</p> <p>Load (relay) Operate Release (Between brown and black)</p>	Dark ON	
E3X-DA11RM-S E3X-DA6RM-S	LIGHT ON (L/ON)	<p>Incident light</p> <p>No incident light</p> <p>Operation indicator (orange) ON OFF</p> <p>Output transistor ON OFF</p> <p>Load (relay) Operate Release (Between brown and black)</p>	Light ON	
	DARK ON (D/ON)	<p>Incident light</p> <p>No incident light</p> <p>Operation indicator (orange) ON OFF</p> <p>Output transistor ON OFF</p> <p>Load (relay) Operate Release (Between brown and black)</p>	Dark ON	

Note: 1. The ON/OFF regions when areas settings are used with the E3X-DA□TW-S are as follows:
 LIGHT ON: ON when the incident level is between the thresholds for channels 1 and 2.
 DARK ON: OFF when the incident level is between the thresholds for channels 1 and 2.
 2. Time Charts for Timer Settings (T: Set Time)

ON delay	OFF delay	One-shot
<p>Incident light</p> <p>No incident light</p> <p>ON</p> <p>L-ON</p> <p>OFF</p> <p>D-ON</p> <p>ON</p> <p>OFF</p>	<p>Incident light</p> <p>No incident light</p> <p>ON</p> <p>L-ON</p> <p>OFF</p> <p>D-ON</p> <p>ON</p> <p>OFF</p>	<p>Incident light</p> <p>No incident light</p> <p>ON</p> <p>L-ON</p> <p>OFF</p> <p>D-ON</p> <p>ON</p> <p>OFF</p>

PNP Output

Model	Mode selector	Timing chart	State of output transistor	Output circuit
E3X-DA41-S E3X-DA8-S E3X-DAG41-S E3X-DAG8-S E3X-DAB41-S E3X-DAB8-S	LIGHT ON (L/ON)	Incident light No incident light Operation indicator (orange) ON OFF Output transistor ON OFF Load (relay) Operate Release (Between blue and black)	Light ON	
	DARK ON (D/ON)	Incident light No incident light Operation indicator (orange) ON OFF Output transistor ON OFF Load (relay) Operate Release (Between blue and black)	Dark ON	
E3X-DA41TW-S E3X-DA8TW-S	LIGHT ON (L/ON)	CH1/ CH2 Incident light No incident light Operation indicator (orange) ON OFF Output transistor ON OFF Load (relay) Operate Release (Between blue and black)	Light ON	
	DARK ON (D/ON)	CH1/ CH2 Incident light No incident light Operation indicator (orange) ON OFF Output transistor ON OFF Load (relay) Operate Release (Between blue and black)	Dark ON	
E3X-DA41RM-S E3X-DA8RM-S	LIGHT ON (L/ON)	Incident light No incident light Operation indicator (orange) ON OFF Output transistor ON OFF Load (relay) Operate Release (Between blue and black)	Light ON	
	DARK ON (D/ON)	Incident light No incident light Operation indicator (orange) ON OFF Output transistor ON OFF Load (relay) Operate Release (Between blue and black)	Dark ON	

Note: 1. The ON/OFF regions when areas settings are used with the E3X-DA□TW-S are as follows:

- LIGHT ON: ON when the incident level is between the thresholds for channels 1 and 2.
- DARK ON: OFF when the incident level is between the thresholds for channels 1 and 2.

2. Time Charts for Timer Settings (T: Set Time)

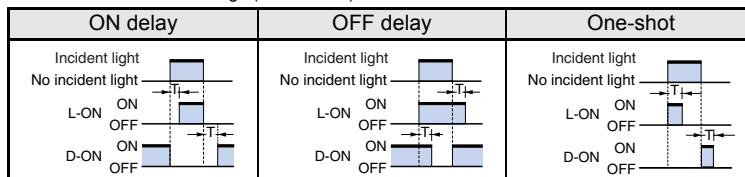

Nomenclature

Amplifier Units

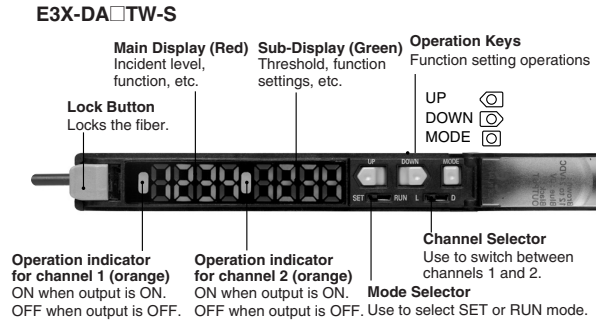
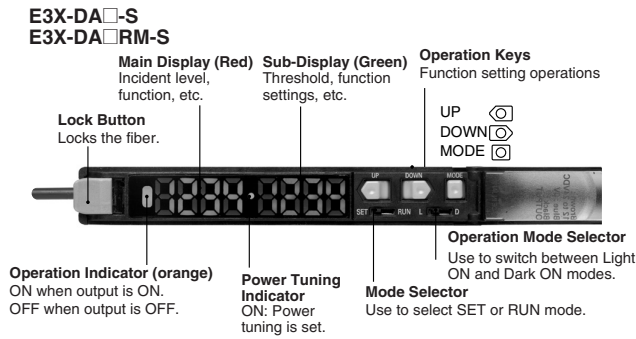

Common adjustment methods*1

1. Setting the Operation Mode

The operation mode is set with the Mode Selector.

Operation mode		Operation
Light ON	L-ON	L (Factory-set)
Dark ON	D-ON	 D

* E3X-DA□TW-S: The operation mode is set in SET mode. Refer to page 410, 5. Convenient Functions.

* E3X-DA□TW-S: Set the Channel Selector to the desired channel before making any adjustments or settings. This is true for all adjustments and settings.

2. Adjusting the Power (RUN Mode)

The current incident light level can be adjusted to near the power tuning target value (default: 2,000).

* Confirm that the MODE key setting is PTUN (power tuning). The default setting is PTUN. Refer to page 410, 5. Convenient Functions

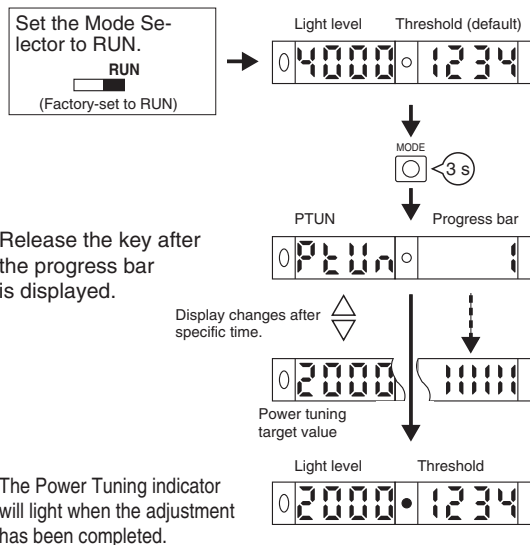

To restore the default power settings:

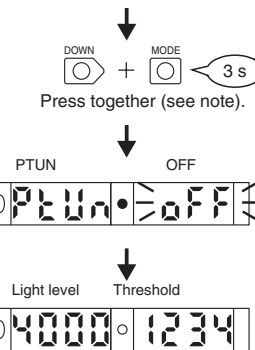

The Power Tuning indicator will go out when the default setting has been restored.

* Setting Errors

An error has occurred if one of the following displays appears after the progress bar is displayed.

Display	Error	Action
PTUN OVER	Over Error The incident light level is too low for the power tuning target value.	The power will not be tuned. The power can be increased up to approximately 5 times the incident light value.
PTUN BOTM	Bottom Error The incident light level is too high for the power tuning target value.	The power will be turned to the minimum level. The power can be decreased down to approximately 1/25th the incident light value.

Note: Press the DOWN key right after pressing the MODE key.

3. Setting Thresholds Manually (RUN Mode)

A threshold can be set manually. A threshold value can also be fine-tuned using manual setting after teaching.

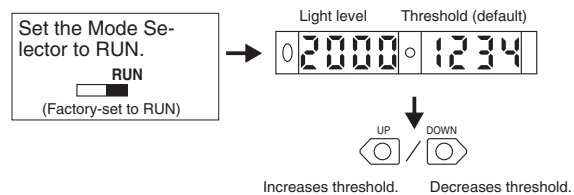

* Even if the display method for display switching is changed, the threshold will appear on the sub-display when the key is pressed.

*1. Further sensor specific functions are described in the attached instruction sheets of fiber amplifiers (E3X-DA□□RM-S, E3X-DA□□TW-S)

4. Teaching the Threshold Value (SET Mode)

- * There are four methods that can be used for teaching, as described below. Use the method most suitable for the application.
- * An error has occurred if OVER, LO, or NEAR is displayed on the sub-display. Repeat the operation from the beginning.

4-1. Setting the Threshold at Maximum Sensitivity

The threshold can be set at the maximum sensitivity. This method is ideal when using a Through-beam Fiber Unit to detect workpieces so that detection is not influenced to any great degree by dust and other environmental factors.

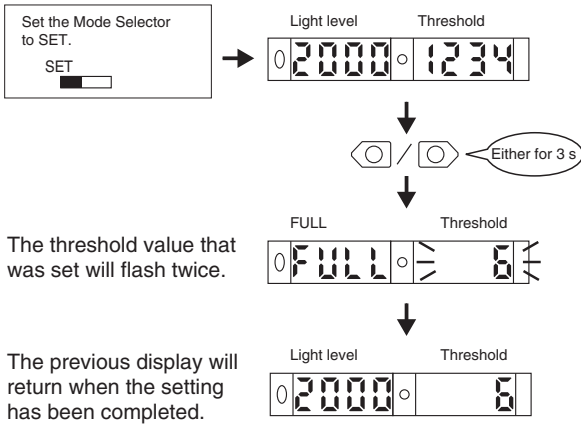

4-2. Teaching a Through-beam Fiber Unit without a Workpiece

A value about 6% less than the incident light level can be set as the threshold value. This method is ideal when detecting very small differences in light level, such as when detecting very fine workpieces or transparent workpieces like transparent fibers.

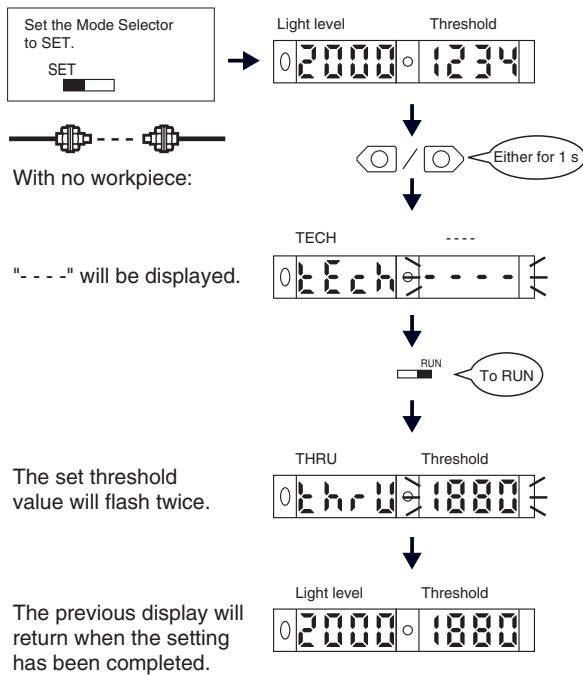

4-3. Teaching a Reflective Fiber Unit without a Workpiece

A value about 6% greater than the incident light level can be set as the threshold value. This method is ideal when using a Reflective Fiber Unit to detect workpieces so that detection is not influenced to any great degree by dust and other environmental factors.

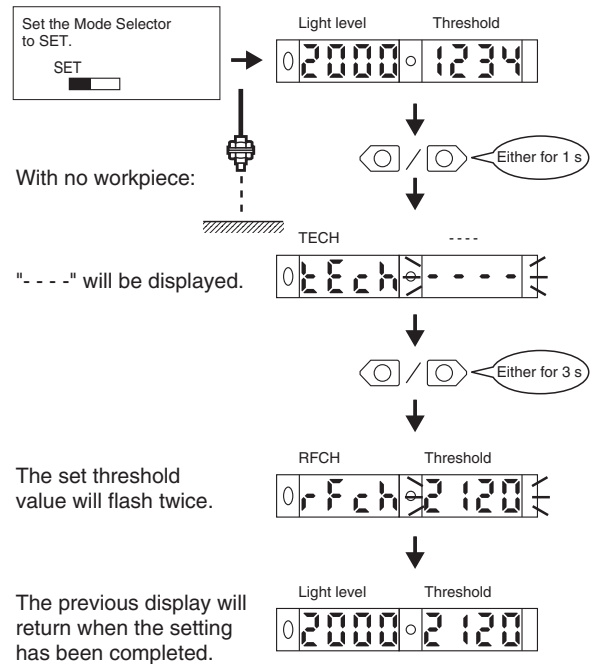

4-4. Teaching With and Without a Workpiece

Teaching can be performed twice, once with and once without a workpiece, and the value between the two measured value can be set as the threshold.

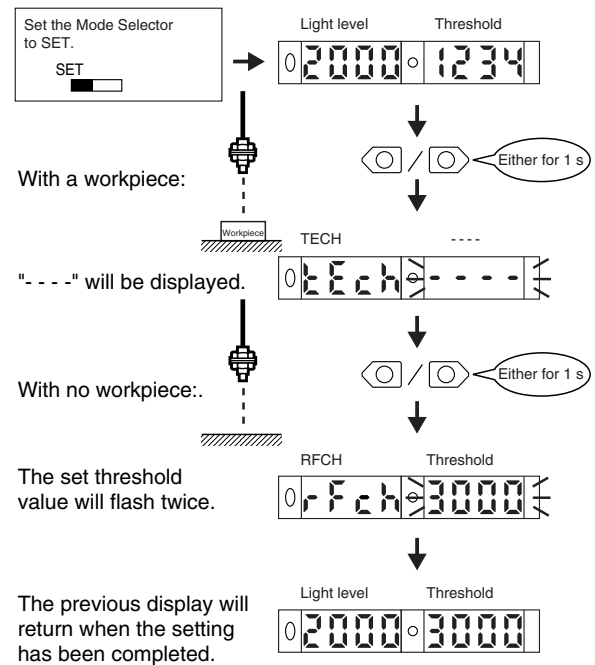

5. Convenient Functions

5-1. Zeroing the Digital Display

The incident light level on the digital display can be set to 0.

* Change the function to ORST (zero reset) with the MODE key. The default setting is PTUN. Refer to 4105. Convenient Functions.

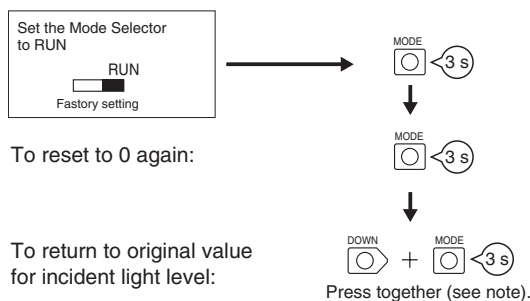

5-2. Locking the Keys

All key operations can be disabled.

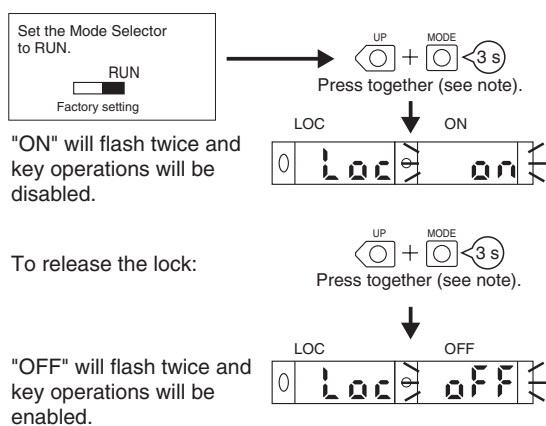

"ON" will flash twice and key operations will be disabled.

"OFF" will flash twice and key operations will be enabled.

* If a key is pressed while key operations are locked, "LOC" will flash twice on the display to indicate that key operations have been disabled.



Note: Press the DOWN key right after pressing the MODE key.

5-3. Initializing Settings

All settings can be returned to their original default settings.

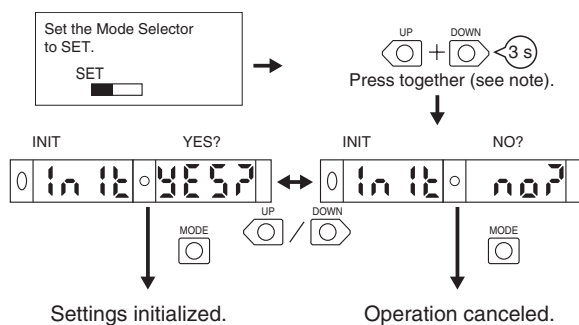

Safety Precautions

Note: In addition to the following precautions, please read and observe the common precautions for the instructions included with the product.

Precautions for Correct Use

Amplifier Unit

Installation

- Operation after Turning Power ON

The Amplifier Unit is ready to operate within 200 ms after the power supply is turned ON. If the Sensor and load are connected to power supplies separately, be sure to turn ON the power supply to the Sensor first.

Mounting

- Connecting and Disconnecting Connectors

Mounting Connectors

1. Insert the Master or Slave Connector into the Amplifier Unit until it clicks into place.

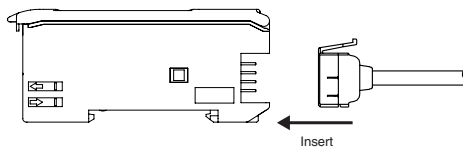

2. Attach the protector seals (provided as accessories) to the sides of master and slave connectors that are not connected.

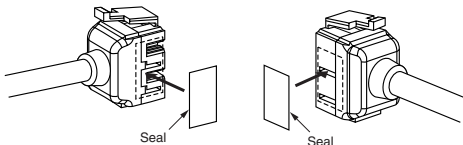

Note: Attach the seals to the sides with grooves

Removing Connectors

1. Slide the slave Amplifier Unit(s) for which the Connector is to be removed away from the rest of the group.
2. After the Amplifier Unit(s) has been separated, press down on the lever on the Connector and remove it. (Do not attempt to remove Connectors without separating them from other Amplifier Units first.)

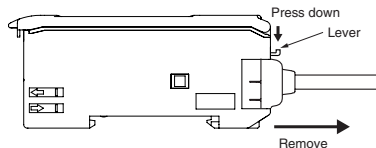

- Joining and Removing Amplifier Units

Joining Amplifier Units

1. Mount the Amplifier Units one at a time onto the DIN track.

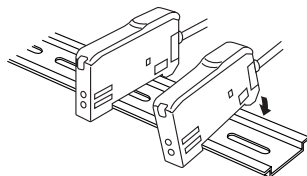

2. Slide the Amplifier Units together, line up the clips, and press the Amplifier Units together until they click into place.

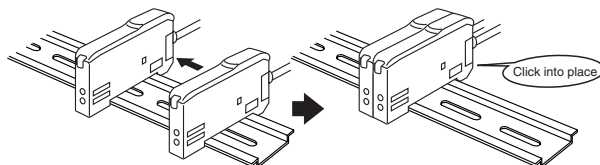

Separating Amplifier Units

Slide Amplifier Units away from each other, and remove from the DIN track one at a time. (Do not attempt to remove Amplifier Units from the DIN track without separating them first.)

Note 1. The specifications for ambient temperature will vary according to the number of Amplifier Units used together. For details, refer to *Ratings/Characteristics*.

2. Always turn OFF the power supply before joining or separating Amplifier Units.

- Mounting the End Plate (PFP-M)

An End Plate should be used if there is a possibility of the Amplifier Unit moving, e.g., due to vibration. If a Mobile Console is going to be mounted, connect the End Plate in the direction shown in the following diagram.

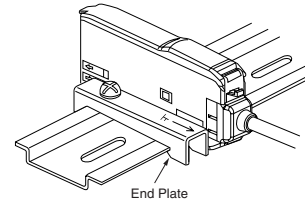

- Mounting the Mobile Console Head

Leave a gap of at least 20 mm between the nearest Amplifier Unit and the Mobile Console head.

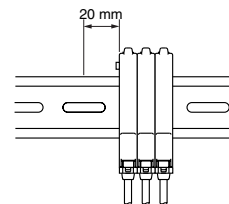

• Fiber Connection

The E3X Amplifier Unit has a lock button for easy connection of the Fiber Unit. Connect or disconnect the fibers using the following procedures:

1. Connection

Open the protective cover, insert the fibers according to the fiber insertion marks on the side of the Amplifier Unit, and lower the lock button.

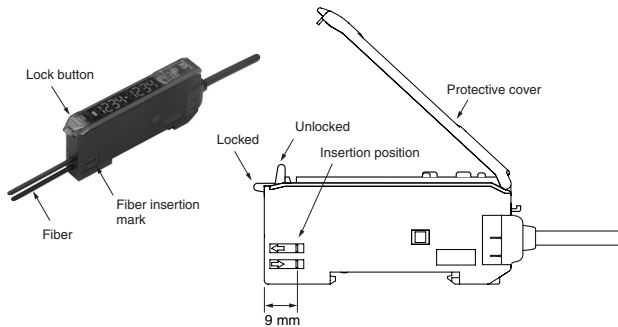

Fibers with E39-F9 Attachment

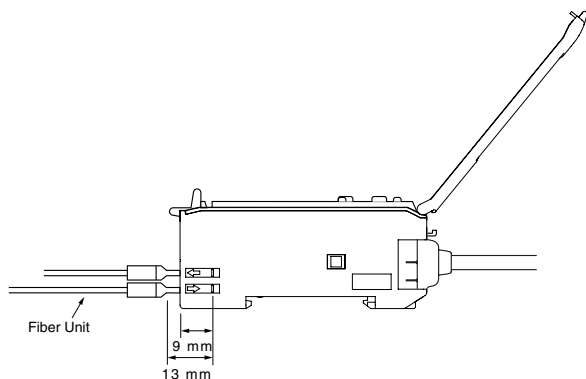

Fibers That Cannot Be Free-Cut (with Sleeves)

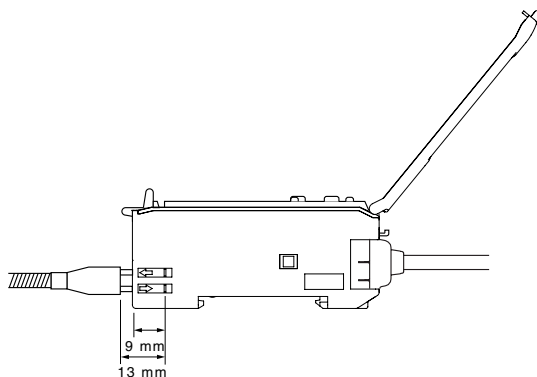

2. Disconnecting Fibers

Remove the protective cover and raise the lock button to pull out the fibers.

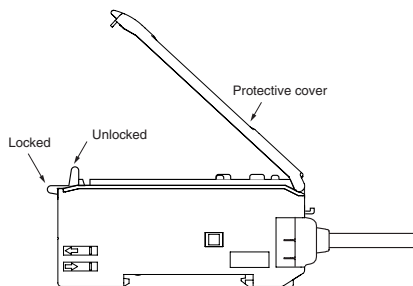

Note 1. To maintain the fiber properties, confirm that the lock is released before removing the fibers.

2. Be sure to lock or unlock the lock button within an ambient temperature range between -10° C and 40° C.

Adjustments

• Mutual Interference Protection Function

There may be some instability in the digital display values due to light from other sensors. If this occurs, decrease the sensitivity (i.e., decrease the power or increase the threshold) to perform stable detection.

• EEPROM Writing Error

If the data is not written to the EEPROM correctly due to a power failure or static-electric noise, initialize the settings with the keys on the Amplifier Unit. ERR/EEP will flash on the display when a writing error has occurred.

• Optical Communications

Several Amplifier Units can be slid together and used in groups. Do not, however, slide the Amplifier Units or attempt to remove any of the Amplifier Units during operation.

Other Precautions

• Protective Cover

Always keep the protective cover in place when using the Amplifier Unit.

• Mobile Console

Use the E3X-MC11-S Mobile Console for the E3X-DA-S-series Amplifier Units. Other Mobile Consoles, such as the E3X-MC11, cannot be used.

Dimensions

Amplifier Units

Amplifier Units with Cables

- E3X-DA11-S
- E3X-DA41-S
- E3X-DAG11-S
- E3X-DAG41-S
- E3X-DAB11-S
- E3X-DAB41-S
- E3X-DA11RM-S
- E3X-DA41RM-S
- E3X-DA11TW-S
- E3X-DA41TW-S

E3X-DA-S

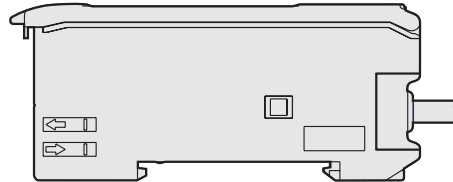
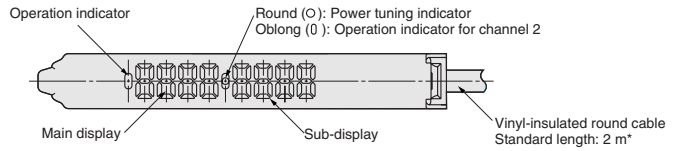

*Cable Specifications

E3X-DA11-S/DA41-S/DAG11-S/DAG41-S/DAB11-S/DAB41-S	A 4-dia., 3-conductor (conductor cross-sectional area: 0.2 mm ² ; insulation diameter: 1.1 mm)
E3X-DA11TW-S/DA41TW-S/DA11RM-S/DA41RM-S	A 4-dia., 4-conductor (conductor cross-sectional area: 0.2 mm ² ; insulation diameter: 1.1 mm)

With Mounting Bracket Attached

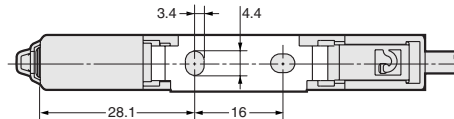
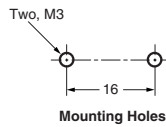
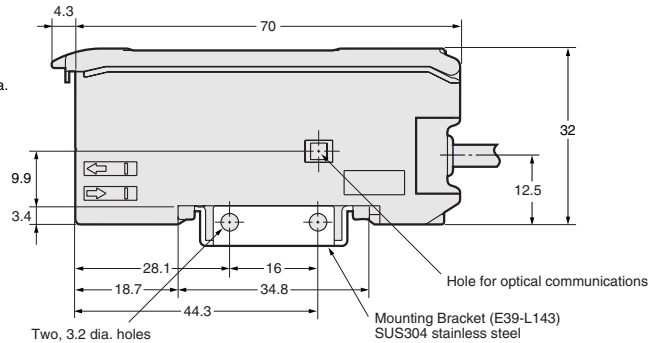
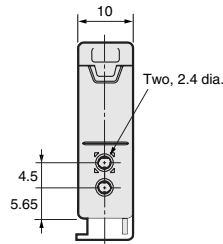
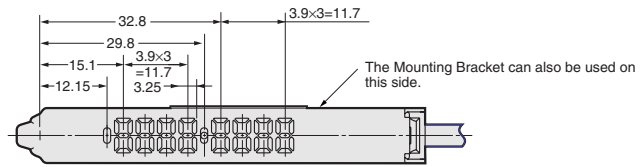

Amplifier Units with Connectors

- E3X-DA6-S
- E3X-DA8-S
- E3X-DAG6-S
- E3X-DAG8-S
- E3X-DAB6-S
- E3X-DAB8-S
- E3X-DA6RM-S
- E3X-DA8RM-S
- E3X-DA6TW-S
- E3X-DA8TW-S

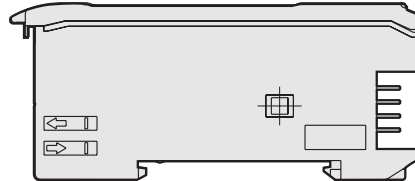
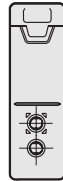
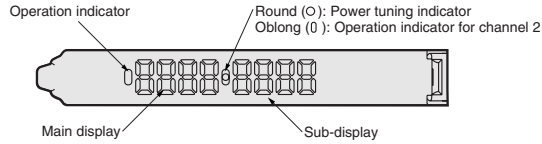

With Mounting Bracket Attached

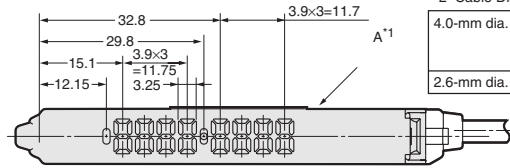

*1 The Mounting Bracket can also be used on this side.
*2 Cable Diameters

4.0-mm dia.	E3X-CN11 (3 conductors)
	E3X-CN21 (4 conductors)
	E3X-CN22 (2 conductors)
2.6-mm dia.	E3X-CN12 (1 conductor)

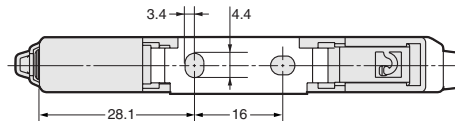
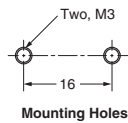
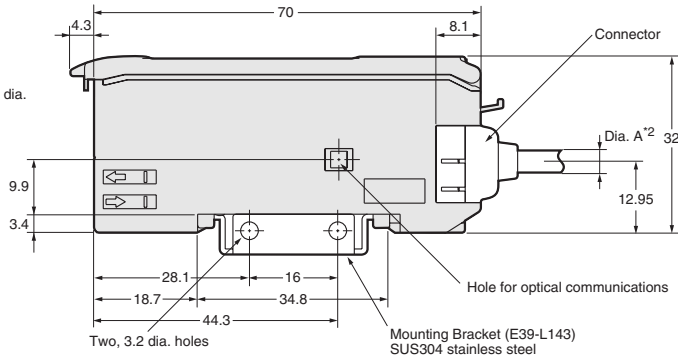
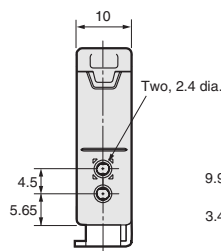

Master Connectors

Amplifier Unit Connectors

- E3X-CN11
- E3X-CN21

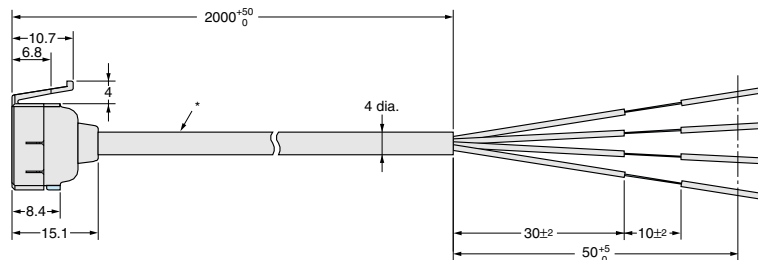
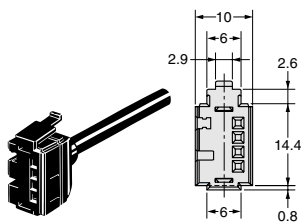

*E3X-CN11: A 4-dia., 3-conductor, vinyl-insulated round cable (conductor cross-sectional area: 0.2 mm²; insulation diameter: 1.1 mm) is used.
E3X-CN21: A 4-dia., 4-conductor, vinyl-insulated round cable (conductor cross-sectional area: 0.2 mm²; insulation diameter: 1.1 mm) is used.

Slave Connectors

E3X-CN12
E3X-CN22

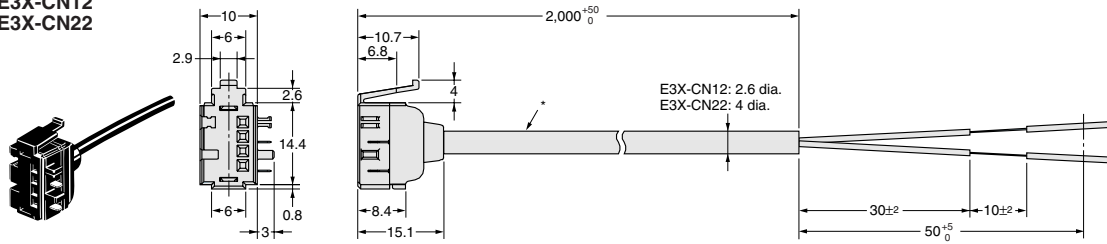

*E3X-CN12: A 2.6-dia., single-conductor, vinyl-insulated round cable (conductor cross-sectional area: 0.2 mm²; insulation diameter: 1.1 mm) is used.
E3X-CN22: A 4-dia., 2-conductor, vinyl-insulated round cable (conductor cross-sectional area: 0.2 mm²; insulation diameter: 1.1 mm) is used.

Mobile Console

E3X-MC11-C1-SV2



Mobile Console

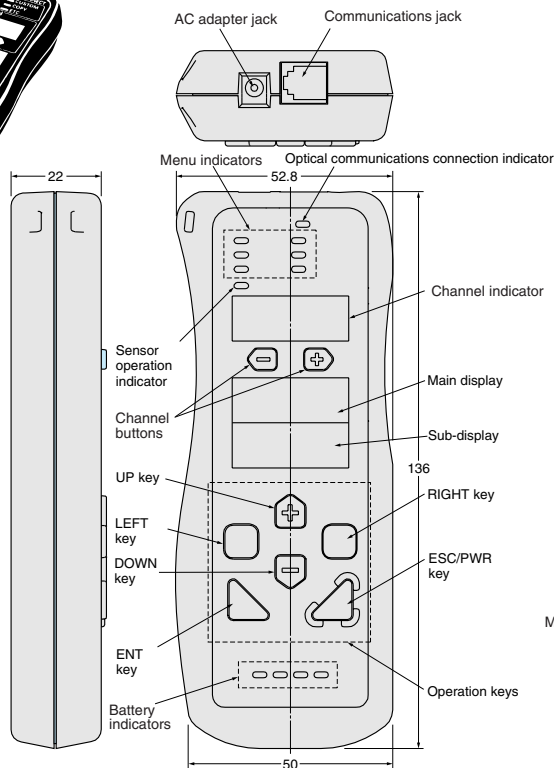

Mobile Console Head

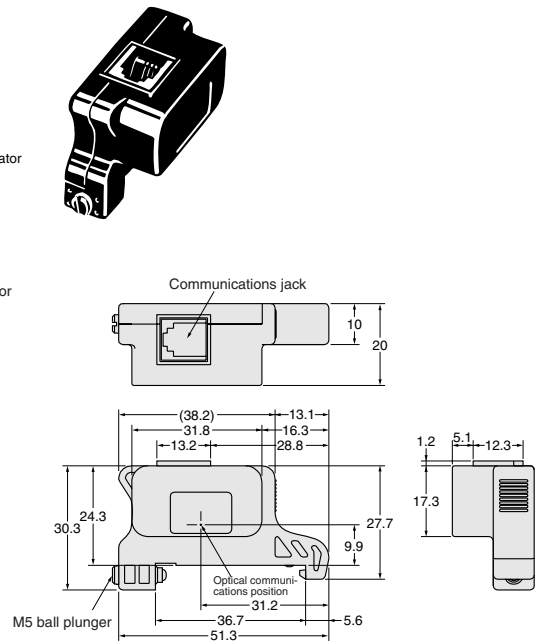

DeviceNet Communication Unit
E3X-DRT21-S

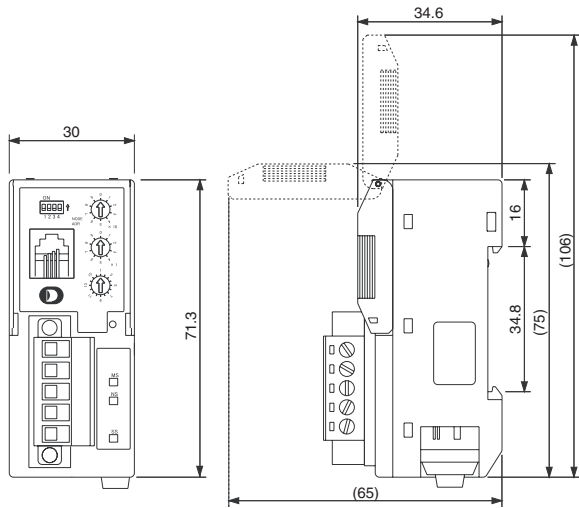

ALL DIMENSIONS SHOWN ARE IN MILLIMETERS.
To convert millimeters into inches, multiply by 0.03937. To convert grams into ounces, multiply by 0.03527.