

U-GAGE[®] T18U Series Sensor

Ultrasonic Opposed Mode Sensor Pairs with Dual Sensing Ranges

Features



- Dual range/dual resolution opposed mode ultrasonic sensors; ideal for reliable sensing of clear objects or materials
- Rugged design for use in demanding environments: rated NEMA 6P (IEC IP67), wide operating temperature range of -40° to $+70^{\circ}\text{C}$
- Alignment indicator flashes at a rate proportional to the received signal strength
- Highly immune to ambient sonic and electrical noise
- Popular T-style right-angle sensor package with 18 mm threaded mounting hub; cabled or quick disconnect models
- 12 to 30V dc operation; choose receivers with either NPN (sinking) or PNP (sourcing) output; outputs are short-circuit protected

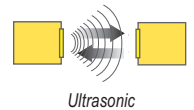

Models

Model	Range*	Cable**	Supply Voltage	Output	Response Time
T186UE	—	—	—	—	—
T18VN6UR	Normal Resolution: 600 mm (24") High Resolution: 300 mm (12")	Standard 2 m (6.5') cable	12 to 30V dc	NPN (sinking)	Normal Resolution: 2 ms High Resolution: 1 ms
T18VP6UR				PNP (sourcing)	

* T18U receivers may be wired for either of two resolution modes: Normal or High (see hookup diagrams, page 4).

** Only standard 2 m (6.5') cable models are listed. For 4-Pin Euro-Style integral QD, add suffix "Q" to the model number (e.g., **T18VN6URQ**). For 9 m (30') cable, add suffix "W/30" to the model number (e.g., **T18VN6UR W/30**). A model with a QD connector requires a mating cable; see page 4.

⚠ WARNING . . . Not To Be Used for Personnel Protection

Never use these products as sensing devices for personnel protection. Doing so could lead to serious injury or death.

These sensors do NOT include the self-checking redundant circuitry necessary to allow their use in personnel safety applications. A sensor failure or malfunction can cause either an energized or de-energized sensor output condition. Consult your current Banner Safety Products catalog for safety products which meet OSHA, ANSI and IEC standards for personnel protection.



40124

U-GAGE® T18U Series Sensor

Overview

U-GAGE® T18U Series Sensors are opposed mode ultrasonic emitter/receiver pairs. They utilize an advanced built-in microprocessor to analyze the received ultrasonic signal and control an indicator LED located on the back of the receiver. The receiver LED flashes at a rate proportional to the received sonic signal strength. This indicator greatly simplifies sensor alignment and alerts personnel to marginal sensing conditions due to gradual misalignment or environmental factors. The receiver is precisely tuned to the ultrasonic emitter, making this sensor pair highly immune to both sonic and electrical ambient noise.

T18U receivers may be wired for either of two resolution modes: NORMAL or HIGH. The modes are selected by the polarity of the supply voltage (see hookup diagrams, page 4). The NORMAL resolution mode offers a sensing range of 600 mm (24") and maximizes sensing energy, as is required in demanding environments. The HIGH resolution mode yields a sensing range of up to 300 mm (12") and maximizes sensing response, as is needed in high-speed counting applications.

Opposed mode ultrasonics are very useful for highly reliable sensing of clear materials, which is always a challenge for photoelectric modes. T18U Series ultrasonic sensors are designed for demanding sensing environments. Housings are tough, NEMA 6P-rated PBT. Electronics are epoxy encapsulated. The acoustic face of both emitter and receiver are epoxy-reinforced for extreme durability and moisture resistance.

Object Detection

These figures reflect the following assumptions:

- Objects have square (not radiused) corners,
- Sensors are optimally aligned,
- Objects pass through the sensing area midway between the emitter and receiver (i.e. at $D/2$)*,
- Operating conditions are stable, with minimal air turbulence.

* In general, the minimum object width and minimum object spacing will decrease if the object (or space) to be detected is passed closer to the emitter or the receiver.

Individual results may differ based on ambient operating conditions, alignment, and the geometry of the objects to be detected.

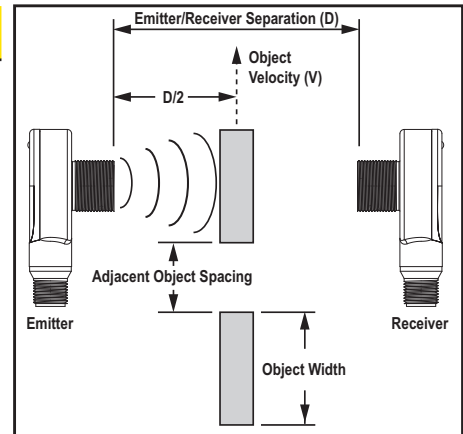

Minimum Object Width (Typical)



Resolution Mode	Emitter/Receiver Separation (D)	Velocity = 0 mm/sec (0 in/sec)	Velocity = 1270 mm/sec (50 in/sec)	Velocity = 2540 mm/sec (100 in/sec)
Normal	150 mm (6")	25.4 mm (1.0")	35.6 mm (1.40")	38.1 mm (1.50")
	300 mm (12")	31.8 mm (1.25")	50.8 mm (2.00")	50.8 mm (2.00")
	600 mm (24")	25.4 mm (1.0")	44.5 mm (1.75")	44.5 mm (1.75")
High	150 mm (6")	15.2 mm (0.60")	19.1 mm (0.75")	20.3 mm (0.80")
	300 mm (12")	12.7 mm (0.50")	19.1 mm (0.75")	25.4 mm (1.0")

Minimum Adjacent Object Spacing (Typical)

Resolution Mode	Emitter/Receiver Separation (D)	Velocity = 0 mm/sec (0 in/sec)	Velocity = 1270 mm/sec (50 in/sec)	Velocity = 2540 mm/sec (100 in/sec)
Normal	150 mm (6")	0.8 mm (0.03")	1.0 mm (0.04")	1.3 mm (0.05")
	300 mm (12")	2.5 mm (0.10")	3.8 mm (0.15")	5.1 mm (0.20")
	600 mm (24")	8.9 mm (0.35")	10.2 mm (0.40")	12.7 mm (0.50")
High	150 mm (6")	3.3 mm (0.13")	3.8 mm (0.15")	4.3 mm (0.17")
	300 mm (12")	10.2 mm (0.40")	11.4 mm (0.45")	11.4 mm (0.45")

U-GAGE® T18U Series Sensor

Specifications

Sensing Range	Normal Resolution: 600 mm (24") High Resolution: 300 mm (12")
Ultrasonic Frequency	230 KHz
Minimum Spacing (adjacent pairs)	50 mm for emitter-to-receiver separations of up to 150 mm. Add 10 mm of adjacent pair spacing for every 100 mm of emitter-to-receiver spacing beyond 150 mm.
Supply Voltage	12 to 30V dc (10% max. ripple)
Supply Current	50 mA (emitters); 35 mA (receivers), exclusive of output load
Receiver Output Configuration	NPN (sinking) or PNP (sourcing), depending on model; Normally Open (NO) and Normally Closed (NC) (complementary)
Output Rating	150 mA max. (each output) at 25°C, derated to 100 mA at 70°C (derate ≈ 1 mA per °C). Both outputs may be used simultaneously. ON-state saturation voltage: < 1.5V at 10 mA; < 2.0V at 150 mA OFF-state leakage current: < 1 microamp at 30V dc
Output Protection Circuitry	Protected against overload and short circuit conditions. No false pulse upon receiver power-up.
Delay at Power-up	100 milliseconds
Output Response Time	Normal Resolution Mode: 2 milliseconds ON and OFF High Resolution Mode: 1 millisecond ON and OFF
Rep Rate	Normal Resolution Mode: 125 Hz max. High Resolution Mode: 200 Hz max.
Mechanical Sensing Repeatability at 300 mm (12") Range	Normal Resolution Mode: < 2 mm (< 0.08") High Resolution Mode: < 1 mm (< 0.04")
Beam Angle (-3dB full angle)	15 ± 2°
Indicators	Emitters have a Green LED for Power ON. Receivers have one Green Power LED and one Yellow Signal LED. Green Power LED: ON indicates power on Flashing indicates output overload Yellow Signal LED: sonic signal received (flash rate is proportional to received signal strength; flash is from full to half intensity)
Construction	Patented T-style yellow PBT housing with black PBT back cover. Transducer housing is threaded M18 x 1. Mating jam nut is supplied for mounting. Acoustic face is epoxy reinforced. Circuitry is epoxy encapsulated.
Connections	Emitter: 2 m (6.5') attached PVC-covered 2-wire cable or 4-pin Euro-Style quick disconnect fitting Receiver: 2 m (6.5') attached PVC-covered 4-wire cable or 4-pin Euro-Style quick disconnect fitting 9 m (30') cables available by request. A model with a QD connector requires a mating cable; see page 4.
Environmental Rating	NEMA 6P, IEC IP67.
Operating Conditions	Temperature: -40° to +70°C (-40° to +158° F)
Vibration and Mechanical Shock	All models meet Mil. Std. 202F requirements method 201A (vibration: 10 to 60 Hz max. double amplitude 0.06", max. acceleration 10G) and method 213B conditions H & I (Shock: 75G with unit operation: 100G for non-operation) Also meets IEC 947-5-2; 30G, 11 ms duration, half sine wave.
Certifications	  

U-GAGE® T18U Series Sensor

Hookups

Emitter*

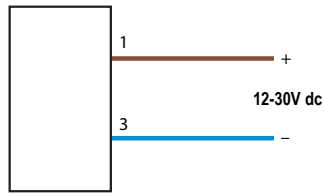

* Emitter also functional with reverse polarity

- Key**
 1 = Brown
 2 = White
 3 = Blue
 4 = Black

NPN (Normal Resolution)

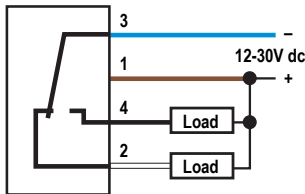

NPN (High Resolution)

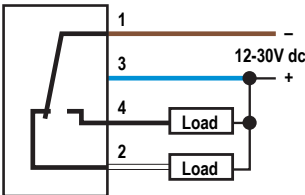

PNP (Normal Resolution)

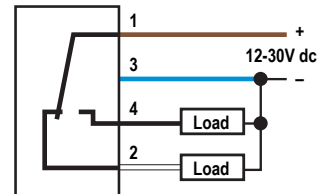

PNP (High Resolution)

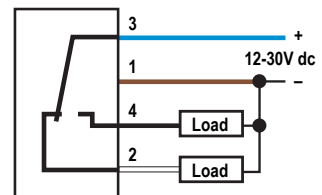

Dimensions

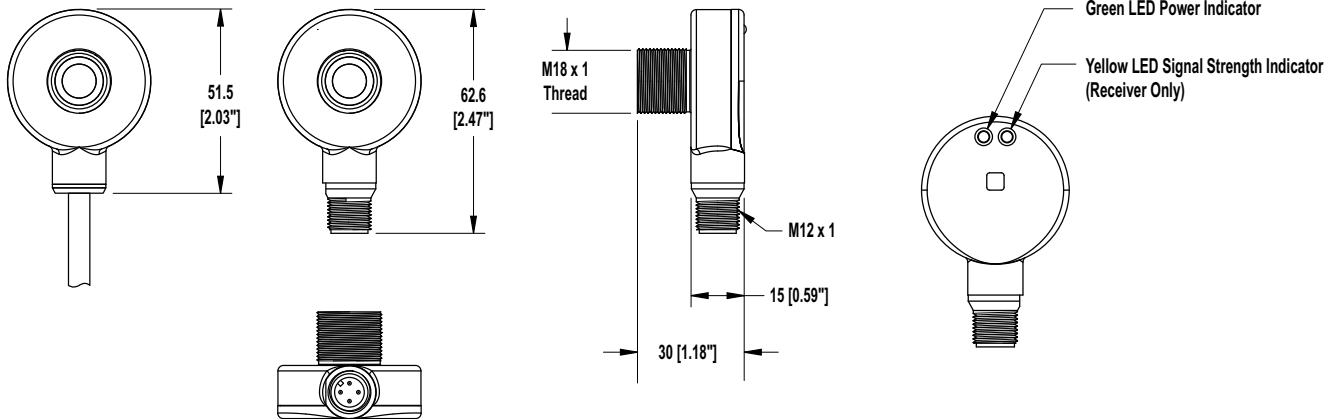

Quick-Disconnect Cables

Style	Model	Length	Dimensions	Pinout
4-Pin Euro Straight	MQDC-406 MQDC-415 MQDC-430	2 m (6.5') 5 m (15') 9 m (30')		Female 1 = Brown 2 = White 3 = Blue 4 = Black
4-Pin Euro Right-Angle	MQDC-406RA MQDC-415RA MQDC-430RA	2 m (6.5') 5 m (15') 9 m (30')		



WARRANTY: Banner Engineering Corp. warrants its products to be free from defects for one year. Banner Engineering Corp. will repair or replace, free of charge, any product of its manufacture found to be defective at the time it is returned to the factory during the warranty period. This warranty does not cover damage or liability for the improper application of Banner products. This warranty is in lieu of any other warranty either expressed or implied.

P/N 40124 rev. B

Banner Engineering Corp., 9714 Tenth Ave. No., Minneapolis, MN USA 55441 • Phone: 763.544.3164 • www.bannerengineering.com • Email: sensors@bannerengineering.com