

Piezoelectronic Buzzers(without circuit)

PS Series(Pin Terminal/Lead)

Conformity to RoHS Directive

FEATURES

- The PS series are high-performance buzzers that employ unimorph piezoelectric elements and are designed for easy incorporation into various circuits.
- They feature extremely low power consumption in comparison to electromagnetic units.
- Because these buzzers are designed for external excitation, the same part can serve as both a musical tone oscillator and a buzzer.
- They can be used with automated inserters. Moisture-resistant models are also available.
- The lead wire type(PS1550L40N) with both-sided adhesive tape installed easily is prepared.

APPLICATIONS

Electric ranges, washing machines, computer terminals, various devices that require speech synthesis output.

SOUND MEASURING METHOD

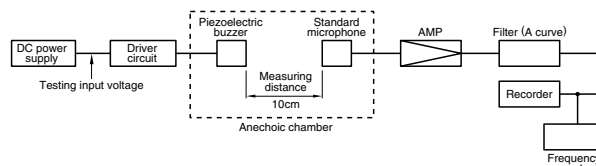

SPECIFICATIONS AND CHARACTERISTICS

Type	Part No.	External dimensions			Characteristics		
		Outer diameter (mm)	Height (mm)	Pitch (mm)	Sound pressure (dB(A)/10cm)	Frequency (kHz)	Input voltage (Vo-p)[Rectangular wave]
PS12 Type	PS1240P02AT	φ12.2	6.5	5	70 min.	4	3
	PS1240P02CT	φ12.2	3.5	5	60 min.	4	3
PS14 Type	PS1440P02BT	φ14	8	5	75 min.	4	3
	PS1420P02AT	φ14	11	5	70 min.	2	5
PS17 Type	PS1720P02	φ17	8	10	70 min.	2	3
PS19 Type	PS1927P02	φ19	10.5 [excluding terminal]	20	90 min.	2.7	10
	PS1920P02	φ19	10.5 [excluding terminal]	20	80 min.	2	10
Others	PS1550L40N	φ15	1.6	—	Depend on the installation condition		

Type	Part No.	Applications	Features
PS12 Type	PS1240P02AT	For warning and alarm sounds of home appliances(air conditioners, refrigerators, fan forced heaters, cordless telephones, etc.)	• Compact • Automatic mountable • 12.7mm pitch radial taping
	PS1240P02CT		• Thin type • Automatic mountable • 12.7mm pitch radial taping
PS14 Type	PS1440P02BT		• High sound pressure • Automatic mountable • 15mm pitch radial taping
	PS1420P02AT		• Low frequency tone • Automatic mountable • 15mm pitch radial taping
PS17 Type	PS1720P02	• Low frequency tone • High sound pressure	
PS19 Type	PS1927P02	For potted circuit (washing machines, drying machines, hot water supply systems, etc.)	• High sound pressure • Water-proof processing element
	PS1920P02		• Low frequency tone • Water-proof processing element
Others	PS1550L40N	Digital camera	• Compact, Thin type • Fix in both-sided adhesive tape

- Conformity to RoHS Directive: This means that, in conformity with EU Directive 2002/95/EC, lead, cadmium, mercury, hexavalent chromium, and specific bromine-based flame retardants, PBB and PBDE, have not been used, except for exempted applications.

- All specifications are subject to change without notice.

PIN TERMINAL TYPE

PS12 TYPE

PS1240P02AT

FEATURES

- Miniature size($\phi 12.2 \times T6.5$ mm).
- High cost performance.
- Suitable for automatic radial taping machine(12.7mm-pitch).

SHAPES AND DIMENSIONS

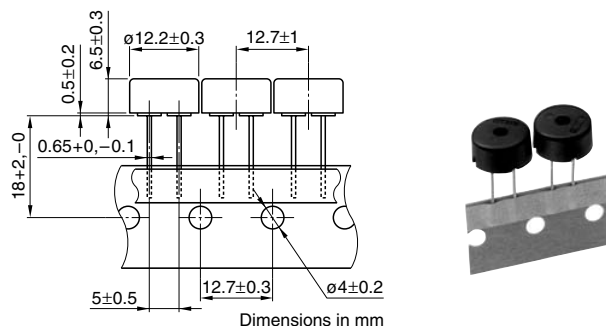

SPECIFICATIONS AND CHARACTERISTICS

Sound pressure	70dBA/ 10cm min.	[at 4kHz, 3V _{0-P} rectangular wave, measuring temperature: 25±5°C, humidity: 60±10%]
Temperature range	Operating -20 to +70°C Storage -30 to +80°C	
Maximum input voltage	30V _{0-P} max.	[without DC bias]
Minimum delivery unit	2500 pieces	[500 pieces/1 reel×5 reels]

FREQUENCY SOUND PRESSURE CHARACTERISTICS

SINE WAVE DRIVE

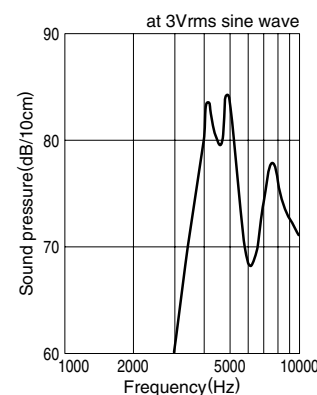

SQUARE WAVE DRIVE

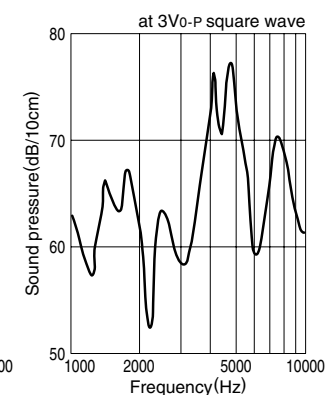

PS1240P02CT

FEATURES

- Thin type($\phi 12.2 \times T3.5$ mm).
- Suitable for automatic radial taping machine(12.7mm-pitch).

SHAPES AND DIMENSIONS

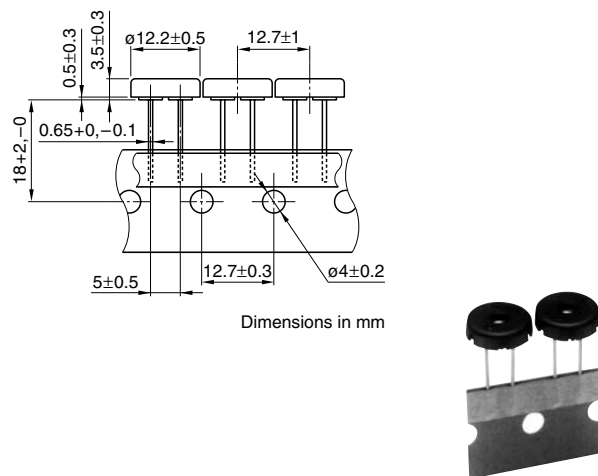

SPECIFICATIONS AND CHARACTERISTICS

Sound pressure	60dBA/ 10cm min.	[at 4kHz, 3V _{0-P} rectangular wave, measuring temperature: 25±5°C, humidity: 60±10%]
Temperature range	Operating -20 to +70°C Storage -30 to +80°C	
Maximum input voltage	30V _{0-P} max.	[without DC bias]
Minimum delivery unit	2500 pieces	[500 pieces/1 reel×5 reels]

FREQUENCY SOUND PRESSURE CHARACTERISTICS

SINE WAVE DRIVE

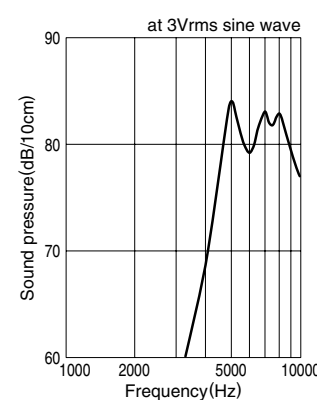

SQUARE WAVE DRIVE

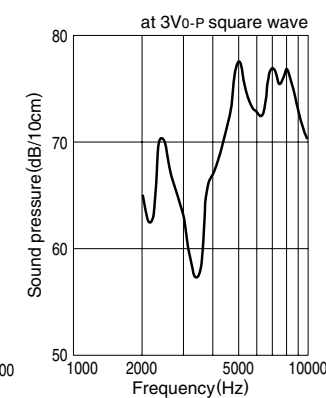

PS14 TYPE

PS1440P02BT

FEATURES

- High sound pressure.
- Miniature size($\phi 14 \times T8$ mm).
- Suitable for automatic radial taping machine(15mm-pitch).

SHAPES AND DIMENSIONS

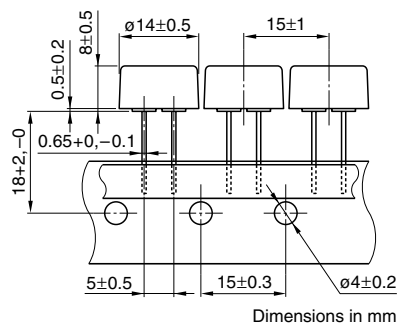

SPECIFICATIONS AND CHARACTERISTICS

Sound pressure	75dBA/ 10cm min.	[at 4kHz, 3V _{0-P} rectangular wave, measuring temperature: 25±5°C, humidity: 60±10%]
	Temperature Operating range -20 to +70°C	
	Storage -30 to +80°C	
Maximum input voltage	30V _{0-P} max.	[without DC bias]
Minimum delivery unit	1750 pieces	[350 pieces/1 reel×5 reels]

FREQUENCY SOUND PRESSURE CHARACTERISTICS

SINE WAVE DRIVE

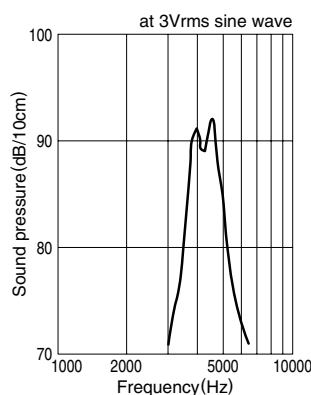

SQUARE WAVE DRIVE

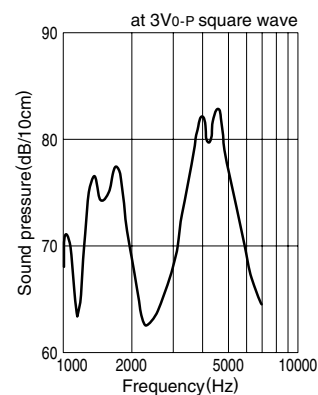

PS1420P02AT

FEATURES

- Low frequency tone(2kHz).
- Suitable for automatic radial taping machine(15mm-pitch).

SHAPES AND DIMENSIONS

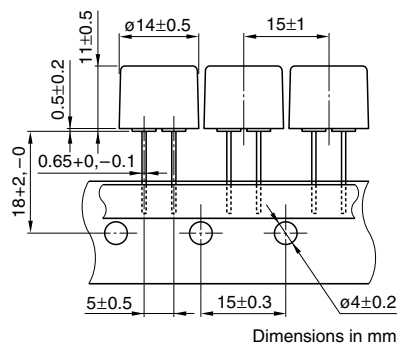

SPECIFICATIONS AND CHARACTERISTICS

Sound pressure	70dBA/ 10cm min.	[at 2kHz, 5V _{0-P} rectangular wave, measuring temperature: 25±5°C, humidity: 60±10%]
	Temperature Operating range -20 to +70°C	
	Storage -30 to +80°C	
Maximum input voltage	30V _{0-P} max.	[without DC bias]
Minimum delivery unit	1750 pieces	[350 pieces/1 reel×5 reels]

FREQUENCY SOUND PRESSURE CHARACTERISTICS

SINE WAVE DRIVE

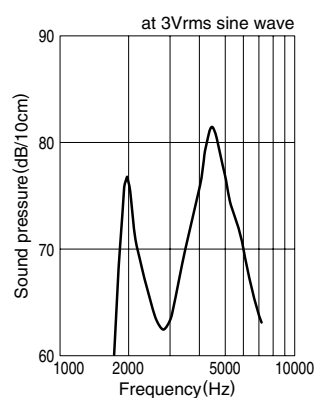

SQUARE WAVE DRIVE

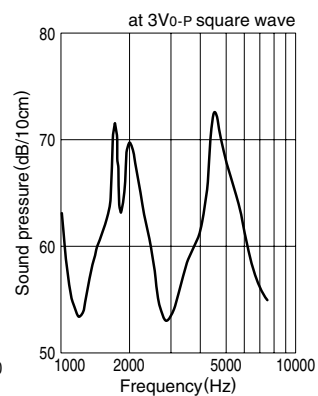

PS17 TYPE**PS1720P02****FEATURES**

- Low frequency tone.
- High sound pressure.

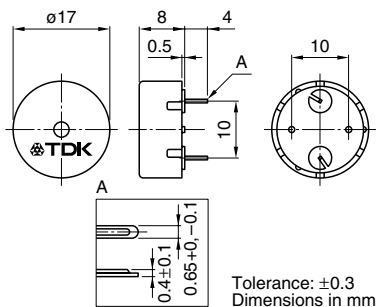
SHAPES AND DIMENSIONS**SPECIFICATIONS AND CHARACTERISTICS**

Sound pressure	70dBA/	[at 2kHz, 3V _{0-P} rectangular
	10cm min.	wave, measuring temperature:
		25 \pm 5°C, humidity: 60 \pm 10%]
Temperature range	Operating	-20 to +70°C
	Storage	-30 to +80°C
Maximum input voltage	30V _{0-P} max.	[without DC bias]
Minimum delivery unit	1500 pieces	

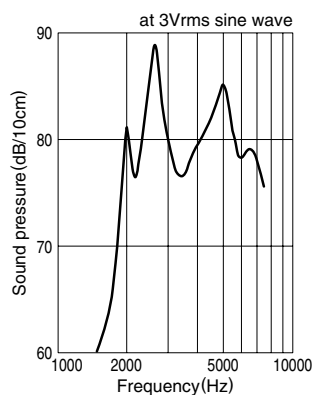
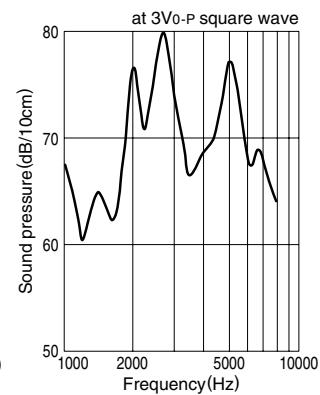
FREQUENCY SOUND PRESSURE CHARACTERISTICS**SINE WAVE DRIVE****SQUARE WAVE DRIVE****PS19 TYPE****PS1920P02****FEATURES**

- Low frequency tone(2kHz).
- Piezo element is coated with water proof processing.

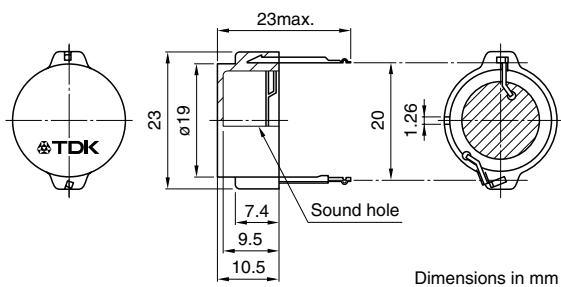
SHAPES AND DIMENSIONS

- It considers that water escapes from sound release hole and please decide an attachment angle.

**SPECIFICATIONS AND CHARACTERISTICS**

Sound pressure	80dBA/	[at 2kHz, 10V _{0-P} rectangular
	10cm min.	wave, measuring temperature:
		25 \pm 5°C, humidity: 60 \pm 10%]
Temperature range	Operating	-20 to +70°C
	Storage	-30 to +80°C
Maximum input voltage	20V _{0-P} max.	[without DC bias]
Minimum delivery unit	600 pieces	

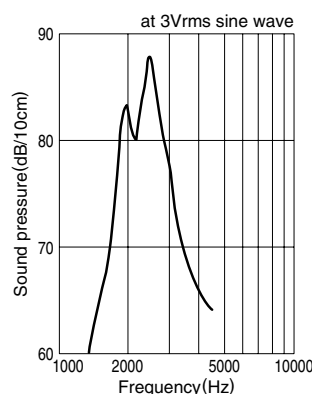
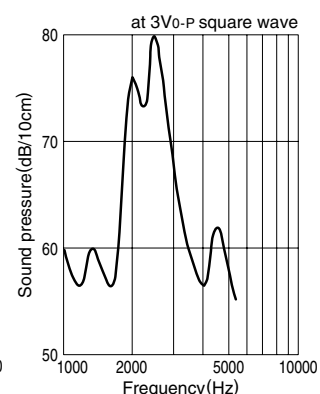
FREQUENCY SOUND PRESSURE CHARACTERISTICS**SINE WAVE DRIVE****SQUARE WAVE DRIVE**

PS19 TYPE**PS1927P02****FEATURES**

- High sound pressure.
- Piezo element is coated with water proof processing.

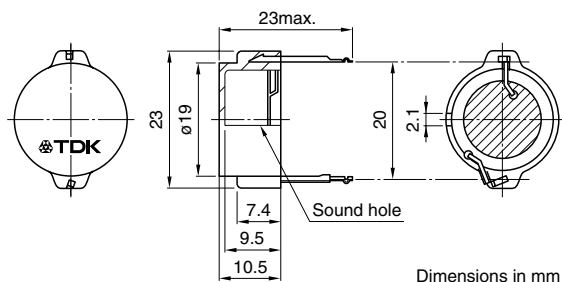
SHAPES AND DIMENSIONS

- It considers that water escapes from sound release hole and please decide an attachment angle.

**LEAD WIRE TYPE****PS15 TYPE****PS1550L40N****FEATURES**

- Miniature size($\phi 15 \times T1.6$ mm).
- High cost performance.
- The installation of this type is easy with both-sided tape.
- This product adopts an excellent both-sided adhesive tape in bonding and the sound characteristic.

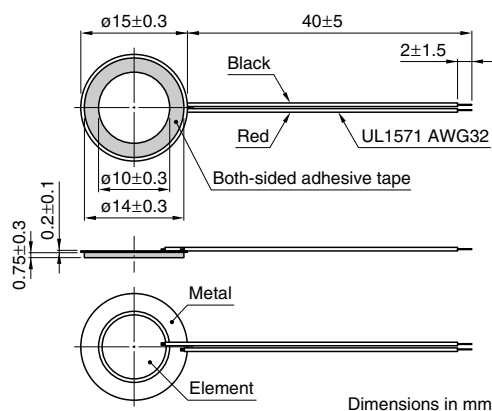
SHAPES AND DIMENSIONS**SPECIFICATIONS AND CHARACTERISTICS**

Sound pressure	90dBA/	[at 2.7kHz, 10V _{0-P} rectangular wave, measuring temperature: 25±5°C, humidity: 60±10%]
	10cm min.	
Temperature range	Operating	-20 to +70°C
	Storage	-30 to +80°C
Maximum input voltage	20V _{0-P} max.	[without DC bias]
Minimum delivery unit	600 pieces	

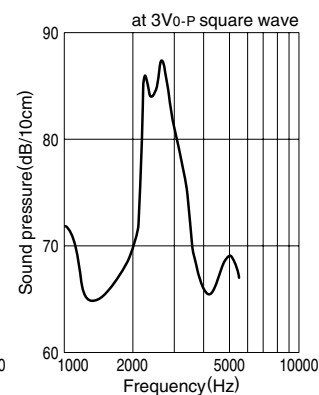
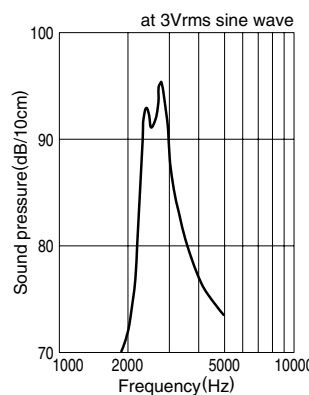
FREQUENCY SOUND PRESSURE CHARACTERISTICS**SINE WAVE DRIVE****SQUARE WAVE DRIVE****SPECIFICATIONS AND CHARACTERISTICS**

Temperature range	Operating	-20 to +70°C
	Storage	-30 to +80°C
Maximum input voltage	20V _{0-P} max.	[without DC bias]
Minimum delivery unit	4000 pieces	

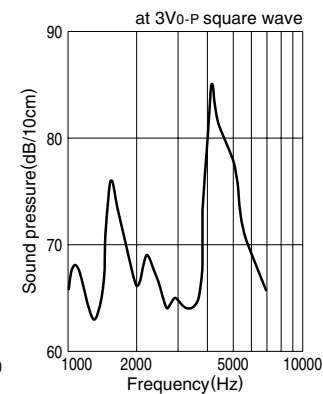
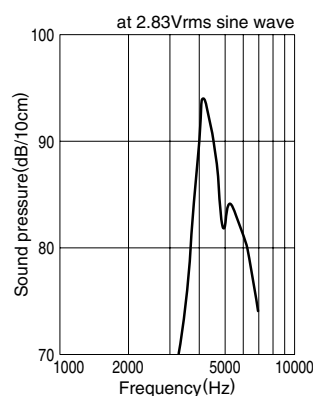
FREQUENCY SOUND PRESSURE CHARACTERISTICS**SINE WAVE DRIVE****SQUARE WAVE DRIVE**

* The frequency characteristic changes depending on the case shape and the installation method.

PRECAUTIONS FOR USE

- Do not apply DC bias to the piezoelectric buzzer; otherwise insulation resistance may become low and affect the performance.
- Do not supply any voltage higher than applicable to the piezoelectric buzzer.
- Do not use the piezoelectric buzzer outdoors. It is designed for indoor use. If the piezoelectric buzzer has to be used outdoors, provide it with waterproofing measures; it will not operate normally if subjected to moisture.
- Do not wash the piezoelectric buzzer with solvent or allow gas to enter it while washing; any solvent that enters it may stay inside a long time and damage it.
- A piezoelectric ceramic material of approximately 100 μ m thick is used in the sound generator of the buzzer. Do not press the sound generator through the sound release hole otherwise the ceramic material may break. Do not stack the piezoelectric buzzers without packing.
- Do not apply any mechanical force to the piezoelectric buzzer; otherwise the case may deform and result in improper operation.
- Do not place any shielding material or the like just in front of the sound release hole of the buzzer; otherwise the sound pressure may vary and result in unstable buzzer operation. Make sure that the buzzer is not affected by a standing wave or the like.
- Be sure to solder the buzzer terminal at 350°C max.(80W max.)(soldering iron trip) within 5 seconds using a solder containing silver.
- Avoid using the piezoelectric buzzer for a long time where any corrosive gas (H₂S, etc.) exists; otherwise the parts or sound generator may corroded and result in improper operation.
- Be careful not to drop the piezoelectric buzzer.

RECOMMENDED OPERATING CIRCUIT EXAMPLE

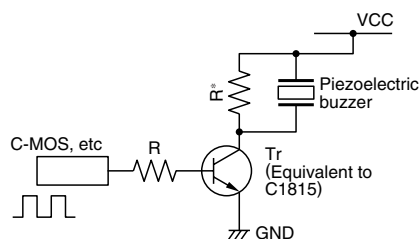

* Resistor to do charging and discharging to a piezoelectric element (Value of about 1k Ω is good efficiency).