

	Photoelectric proximity switches, BGS
	Photoelectric reflex switches
	Through-beam photoelectric switches

W 36: Mastering complex tasks reliably



electric proximity switch, which also offers adjustable scanning distance and background suppression.

Great demands are often placed on the mechanical endurance of sensors. Suitable enclosure ratings (depending on the type of connection) of IP 65 and IP 67, robust plastic housings, pre-failure signalling output and indicator, and insensitivity to ambient light ensure reliable switching in hostile industrial environments.

Users have long appreciated the benefits of the W 36 series of photoelectric switches. Thanks to their design, the devices can be used both indoors and outdoors, since all DC types are suitable for temperatures ranging from -40 to $+55$ °C and polarising filters also make it possible to detect shiny surfaces. The scanning ranges of the W 36 series speak for themselves: 60 metres for the WS/WE 36 through-beam photoelectric switch, 22 metres for the WL 36 photoelectric reflex switch and 800 mm for the WT 36 photo-

Universal voltage versions, time delay, test input and selectable light- or dark-switching are additional characteristic features of the W 36 series.



◀ Making sure that crates are full: WL 36 photoelectric reflex switches used to count coloured bottles before packaging.



▲ WL 36 sensors used to detect mesh baskets in front of a goods lift.



◀ WL 36 photoelectric reflex switches checking the presence of beer crates before automatic removal of the bottle caps.

► Hot or cold, wet, dry or dusty – WL 36 photoelectric reflex switches are designed for use under hostile operating conditions indoors and outdoors – here they are being used on the roll-up gate of a carwash.



Scanning distance
200...800 mm
Photoelectric proximity switches

- Robust plastic housing
- Infrared light
- Selectable time delay



Dimensional drawing

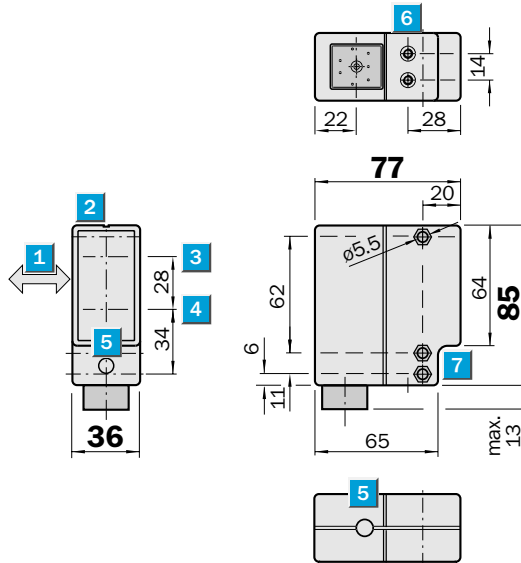

Adjustments possible

WT 36-N 410	WT 36-R 710
WT 36-P 410	
WT 36-N 710	
WT 36-P 710	

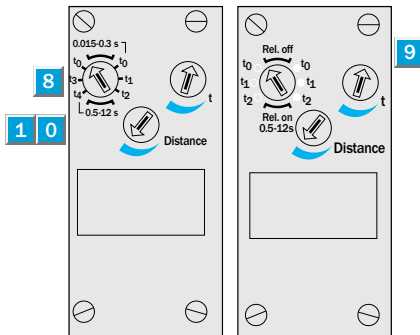

- 1 Standard direction of the material being scanned
- 2 Alignment sight
- 3 Centre of optical axis, receiver
- 4 Centre of optical axis, sender
- 5 LED signal strength indicator
- 6 M5 threaded mounting hole – 5.5 mm deep
- 7 Mounting holes, recesses on both sides for M5 hex nuts
- 8 Time delay selector switch with DC, time delay and light-/dark-switching selector switches with UC
- 9 Time control
- 1 0 Scanning distance adjustment



Switch-selectable time delay

0.015 – 0.3 s with DC only	0.5 – 12 s with DC	0.5 – 12 s with UC
t_0 without time delay	t_0 without time delay	t_0 without time delay
t_1 ON-delay	t_3 ON-delay	t_1 ON-delay
t_2 OFF-delay	t_4 OFF-delay	t_2 OFF-delay

Connection types

WT 36-N 410	WT 36-N 710	WT 36-R 710
WT 36-P 410	WT 36-P 710	

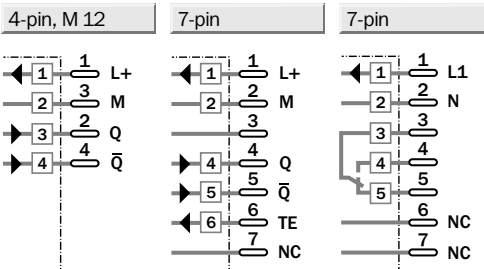
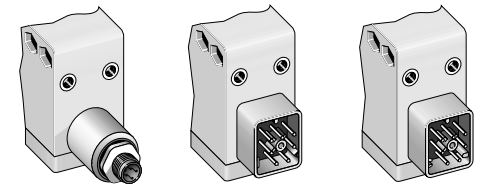

Accessories	page
Cable receptacles	496
Mounting brackets	510

Technical data		WT 36-	N 410	P 410	N 710	P 710	R 710
Scanning distance	200...800 mm, adjustable						
Light source¹⁾, light type	LED, infrared light						
Light spot diameter	Approx. 15 mm at 800 mm						
Supply voltage V_S	10...30 V DC ²⁾						
	24...240 V UC (+ 10 % / - 25 %)						
Ripple ³⁾	$\leq 5 V_{SS}$						
Current consumption ⁴⁾	≤ 50 mA						
Power consumption	< 2 VA						
Switching outputs	PNP, Q and \bar{Q}						
	NPN, Q and \bar{Q}						
	SPDT, isolated ⁵⁾						
Output current I_A max.	200 mA						
Max. switching voltage	AC: 250 V / DC: 120 V						
Switching current	4 A / 240 V AC or 24 V DC						
Max. switching capacity	AC: 1000 VA / DC: 100 W						
Response time ⁶⁾	2 ms						
	6 ms						
Max. switching frequency ⁷⁾	250/s						
	10/s						
Test input "TE", sender OFF	PNP: Test input to 0 V						
	NPN: Test input to V_S						
Connection types	Plug						
VDE protection class⁸⁾	<input type="checkbox"/>						
Circuit protection⁹⁾	A, B, C						
	A, C						
Enclosure rating	IP 65						
	IP 67						
Ambient temperature T_A	Operation - 40 °C... + 55 °C						
	Operation - 25 °C... + 55 °C						
	Storage - 25 °C... + 75 °C						
Weight	Approx. 200 g						
Housing material	Glass-fibre-reinforced plastic						

- 1) Average service life 100,000 h at $T_A = + 25$ °C
- 2) Limit values
- 3) May not exceed or fall short of V_S tolerances

- 4) Without load
- 5) Provide suitable spark suppression for inductive or capacitive loads

- 6) Signal transit time with resistive load
- 7) With light/dark ratio 1:1
- 8) Reference voltage 50 V DC, 250 V AC

- 9) A = V_S connections reverse-polarity protected
- B = Output Q_N and Q_P short-circuit protected
- C = Interference pulse suppression

Scanning distance		Order information												
		<table border="1"> <thead> <tr> <th>Type</th> <th>Part no.</th> </tr> </thead> <tbody> <tr> <td>WT 36-N 410</td> <td>1 011 109</td> </tr> <tr> <td>WT 36-P 410</td> <td>1 011 108</td> </tr> <tr> <td>WT 36-N 710</td> <td>1 006 370</td> </tr> <tr> <td>WT 36-P 710</td> <td>1 006 047</td> </tr> <tr> <td>WT 36-R 710</td> <td>1 005 927</td> </tr> </tbody> </table>	Type	Part no.	WT 36-N 410	1 011 109	WT 36-P 410	1 011 108	WT 36-N 710	1 006 370	WT 36-P 710	1 006 047	WT 36-R 710	1 005 927
Type	Part no.													
WT 36-N 410	1 011 109													
WT 36-P 410	1 011 108													
WT 36-N 710	1 006 370													
WT 36-P 710	1 006 047													
WT 36-R 710	1 005 927													
<ul style="list-style-type: none"> 1 Scanning distance on black, 6 % remission 2 Scanning distance on grey, 18 % remission 														

Scanning distance
 200...800 mm
Photoelectric proximity switches

- Robust plastic housing
- Infrared
- Adjustable background suppression
- Easily accessible terminal chamber
- Selectable time delay



Dimensional drawing

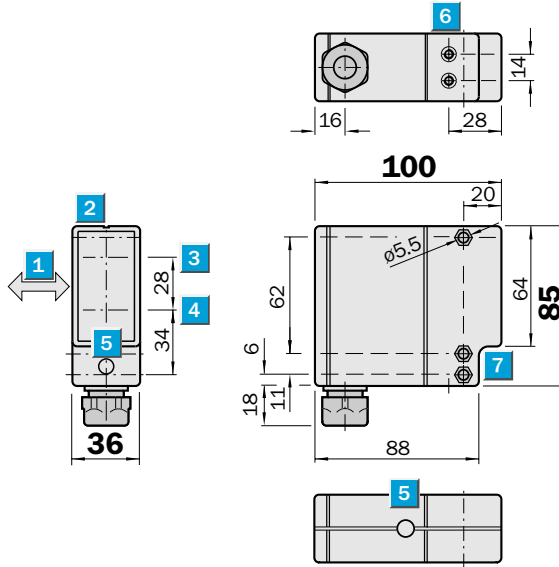

Adjustments possible

WT 36-N 210	WT 36-R 210
WT 36-P 210	

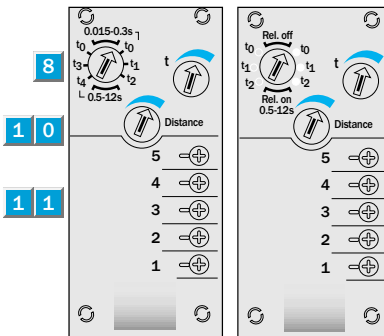

- 1** Standard direction of the material being scanned
- 2** Alignment sight
- 3** Centre of optical axis, receiver
- 4** Centre of optical axis, sender
- 5** LED signal strength indicator
- 6** M5 threaded mounting hole – 5.5 mm deep
- 7** Mounting holes, recesses on both sides for M5 hex nuts
- 8** Time delay selector switch with DC, time delay and light-/dark-switching selector switches with UC
- Light-switching
- Dark-switching
- 9** Time control
- 1 0** Scanning distance adjustment
- 1 1** Terminal connection



Switch-selectable time delay

0.015 – 0.3 s with DC only	0.5 – 12 s with DC	0.5 – 12 s with UC
t_0 without time delay	t_0 without time delay	t_0 without time delay
t_1 ON-delay	t_3 ON-delay	t_1 ON-delay
t_2 OFF-delay	t_4 OFF-delay	t_2 OFF-delay

Connection types

WT 36-N 210	WT 36-R 210
WT 36-P 210	

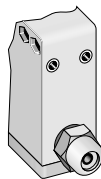

PG 11, terminals

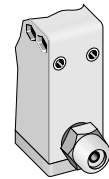
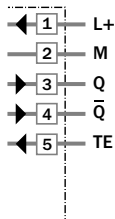

PG 11, terminals

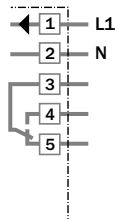

Accessories	page
Mounting brackets	510

Technical data		WT 36-	N 210	P 210	R 210
Scanning distance	200...800 mm, adjustable				
Light source¹⁾, light type	LED, infrared light				
Light spot diameter	Approx. 15 mm at 800 mm				
Supply voltage V_S	10...30 V DC ²⁾				
	24...240 V UC (+ 10 % / - 25 %)				
Ripple ³⁾	$\leq 5 V_{SS}$				
Current consumption ⁴⁾	≤ 50 mA				
Power consumption	< 2 VA				
Switching outputs	PNP, Q and \bar{Q}				
	NPN, Q and \bar{Q}				
	SPDT, isolated ⁵⁾				
Output current I_A max.	200 mA				
Max. switching voltage	AC: 250 V / DC: 120 V				
Switching current	4 A / 240 V AC or 24 V DC				
Max. switching capacity	AC: 1000 VA / DC: 100 W				
Response time ⁶⁾	2 ms				
	6 ms				
Max. switching frequency ⁷⁾	250/s				
	10/s				
Test input "TE", sender OFF	PNP: Test input to 0 V				
	NPN: Test input to V_S				
Connection types	Terminal connection				
VDE protection class⁸⁾	<input type="checkbox"/>				
Circuit protection⁹⁾	A, B, C				
	A, C				
Enclosure rating	IP 67				
Ambient temperature T_A	Operation - 40 °C... + 55 °C				
	Operation - 25 °C... + 55 °C				
	Storage - 25 °C... + 70 °C				
Weight	Approx. 200 g				
Housing material	Glass-fibre-reinforced plastic				

- 1) Average service life 100,000 h at $T_A = + 25$ °C
- 2) Limit values
- 3) May not exceed or fall short of V_S tolerances

- 4) Without load
- 5) Provide suitable spark suppression for inductive or capacitive loads

- 6) Signal transit time with resistive load
- 7) With light/dark ratio 1:1
- 8) Reference voltage 50 V DC, 250 V AC

- 9) A = V_S connections reverse-polarity protected
- B = Output Q_N and Q_P short-circuit protected
- C = Interference pulse suppression

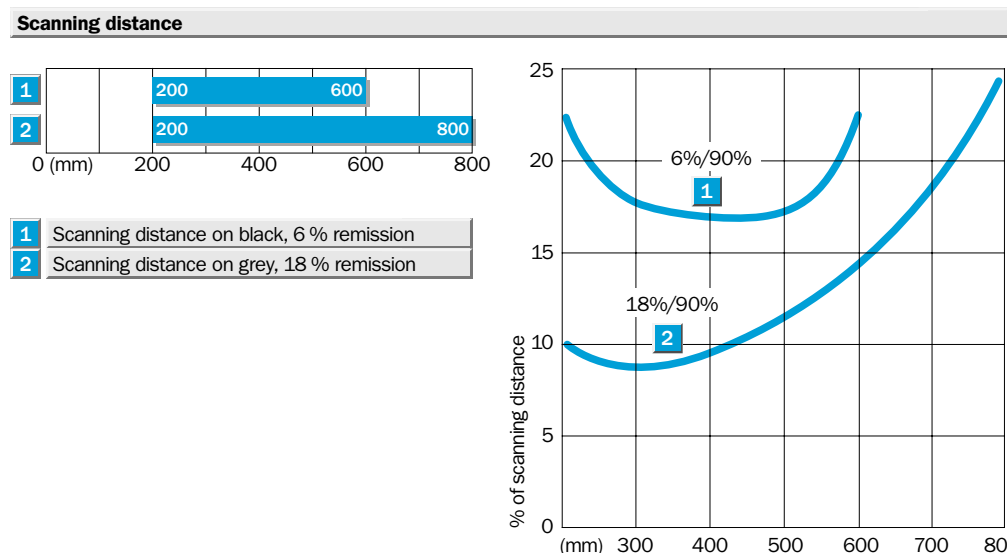

Order information	
Type	Part no.
WT 36-N 210	1 010 109
WT 36-P 210	1 010 108
WT 36-R 210	1 010 110

WL 36 Photoelectric reflex switches, red light - DC



Scanning range
22 m

Photoelectric reflex switches

- Robust plastic housing
- Visible red light
- Selectable time delay

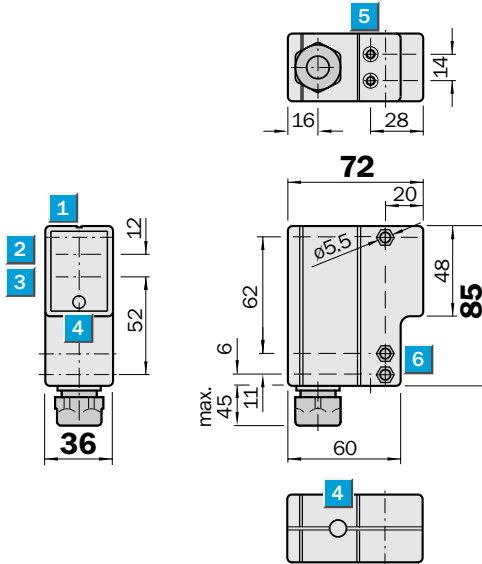

Dimensional drawing



Adjustments possible

WL 36-B 230
WL 36-B 430
WL 36-B 730
WL 36-B 330

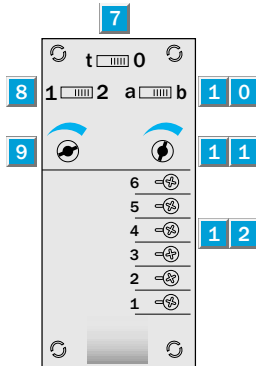

- 1** Alignment sight
- 2** Centre of optical axis, receiver
- 3** Centre of optical axis, sender
- 4** LED signal strength indicator
- 5** M5 threaded mounting hole – 5.5 mm deep
- 6** Mounting holes
recesses on both sides for M5 hex nuts
- 7** ON/OFF timer switch
t = Time ON, 0 = Time OFF
- 8** Time delay
1 ON-delay
2 OFF-delay
- 9** Time control 0.02 to 1 s
- 1 0** Light/dark selector
a = Light-switching, b = Dark-switching
- 1 1** Sensitivity adjustment
- 1 2** Terminal connections



Connection types

WL 36-B 230	WL 36-B 430	WL 36-B 730	WL 36-B 330
-------------	-------------	-------------	-------------

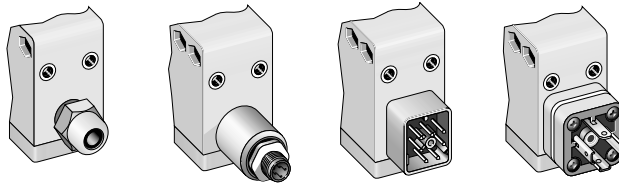

Accessories	page
Cable receptacles	496
Mounting brackets	510
Reflectors	520
Attachable heated cover	556

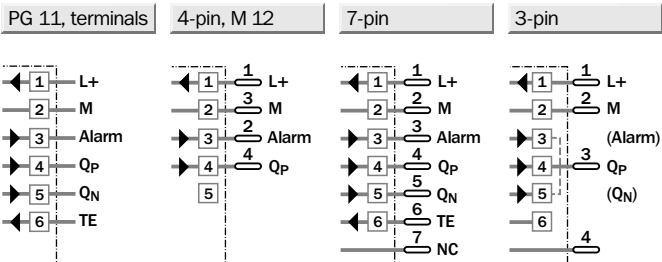

Technical data		WL 36-	B 230	B 430	B 730	B 330
Scanning range , max. typ./on reflector	22 m/PL 80 A					
Sensitivity	Adjustable					
Light source¹⁾, light type	LED, red light					
Light spot diameter	Approx. 50 mm at 3 m					
Supply voltage V_S	10...30 V DC ²⁾					
Ripple ³⁾	≤ 5 V _{SS}					
Current consumption ⁴⁾	≤ 40 mA					
Switching outputs	PNP: Q _P and NPN Q _N					
	PNP: Q _P					
	PNP: Q _P or NPN Q _N					
Light-/dark-switching	Switch-selectable					
Output current I _A max.	200 mA					
Response time ⁵⁾	≤ 1.25 ms					
Max. switching frequency ⁶⁾	400/s					
Pre-failure signalling output	Alarm, PNP, open collector					
Internal resistance	≥ 1.5 kΩ ± 5 %					
Operating condition "correct" ⁷⁾	Output HIGH (V _S - 1.5 V)					
Operating condition "faulty"	Switching periodically at 5/s to V _S					
Test input "TE"	Sender switched off					
Sender OFF	Test input to 0 V					
Connection type	PG cable gland					
	Plug					
VDE protection class⁸⁾	□					
Circuit protection⁹⁾	A, B, C					
Enclosure rating	IP 67					
	IP 65					
Ambient temperature T_A	Operation - 40 °C... + 55 °C					
	Storage - 40 °C... + 70 °C					
Weight	Approx. 165 g					
Polarising filter						
Housing material	Glass-fibre-reinforced plastic					

- 1) Average service life 100,000 h at T_A = + 25 °C
- 2) Limit values
- 3) May not exceed or fall short of V_S tolerances
- 4) Without load
- 5) Signal transit time with resistive load
- 6) With light/dark ratio 1:1
- 7) Signal reserve ≥ 50 %
- 8) Reference voltage 50 V DC
- 9) A = V_S connections reverse-polarity protected
 B = Output Q_N and Q_P short-circuit protected
 C = Interference pulse suppression

Operating range and operating reserve

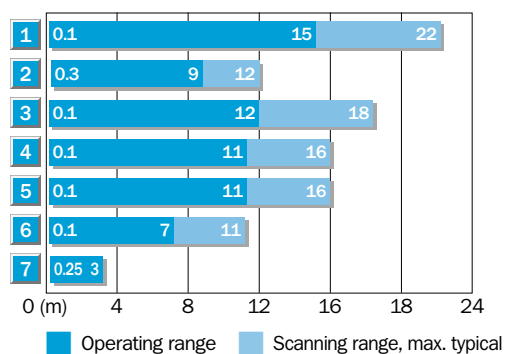

Reflector type	Operating range
1 PL 80 A	0.1...15.0 m
2 C 110	0.3...9.0 m
3 PL 50 A	0.1...12.0 m
4 PL 40 A	0.1...11.0 m
5 PL 30 A	0.1...11.0 m
6 PL 20 A	0.1...7.0 m
7 Reflective tape «Diamond Grade»	0.25...3.0 m

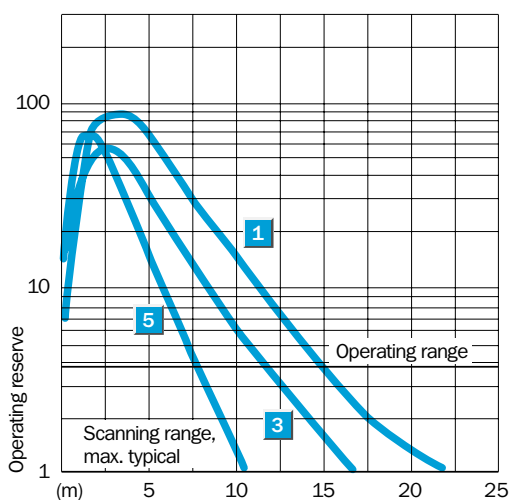

Order information

Type	Part no.
WL 36-B 230	1 005 385
WL 36-B 430	1 010 612
WL 36-B 730	1 008 848
WL 36-B 330	1 005 787



Scanning range
22 m

Photoelectric reflex switches

- Robust plastic housing
- Visible red light
- Easily accessible terminal chamber
- Selectable time delay

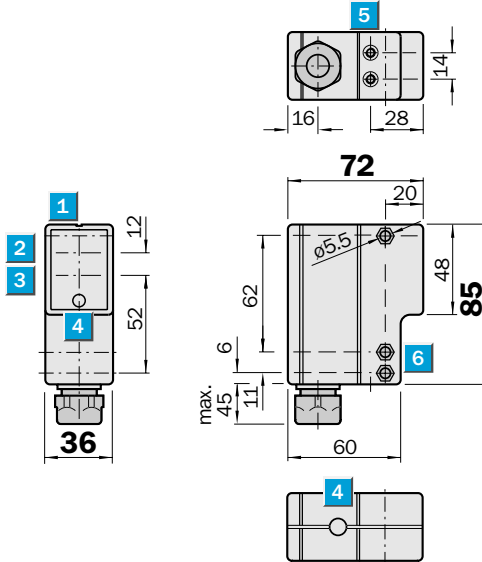

Dimensional drawing



Adjustments possible

WL 36-R 230
WL 36-R 230

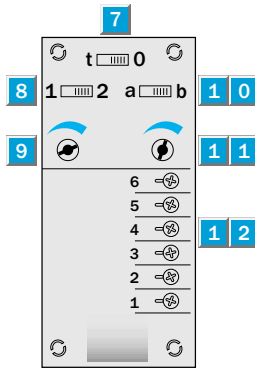

- 1 Alignment sight
- 2 Centre of optical axis, receiver
- 3 Centre of optical axis, sender
- 4 LED signal strength indicator
- 5 M5 threaded mounting hole – 5.5 mm deep
- 6 Mounting holes
recesses on both sides for M5 hex nuts
- 7 ON/OFF timer switch
t = Time ON, 0 = Time OFF
- 8 Time delay
1 ON-delay
2 OFF-delay
- 9 Time control 0.5 to 12 s
- 1 0 Light/dark selector
a = Light-switching, b = Dark-switching
- 1 1 Sensitivity adjustment
- 1 2 Terminal connections



Connection types

WL 36-R 230 WL 36-R 730

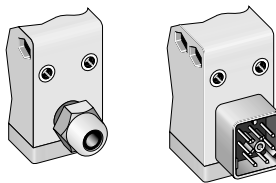

PG 11, terminals

7-pin

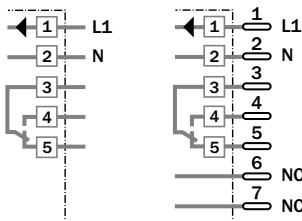

Accessories	page
Cable receptacles	496
Mounting brackets	510
Reflectors	520
Attachable heated cover	556

Technical data		WL 36-	R 230	R 730										
Scanning range , max. typ./on reflector	22 m/PL 80 A													
Sensitivity	Adjustable													
Light source ¹⁾ , light type	LED, red light													
Light spot diameter	Approx. 50 mm at 3 m													
Supply voltage V _S	24...240 V UC (+ 10 %/- 25 %)													
Power consumption	< 2 VA													
Switching output	SPDT, isolated ²⁾													
Max. switching voltage	AC: 250 V / DC: 120 V													
Max. switching current	4 A / 240 V AC or 24 V DC													
Max. switching capacity	AC: 1000 VA / DC: 100 W													
Response time	≤ 20 ms													
Max. switching frequency ³⁾	10/s													
Light-/dark-switching	Switch-selectable													
Connection types	PG cable gland													
	Plug													
VDE protection class ⁴⁾	□													
Circuit protection ⁵⁾	A, C													
Enclosure rating	IP 67													
	IP 65													
Ambient temperature T _A	Operation - 25 °C... + 55 °C													
	Storage - 40 °C... + 70 °C													
Weight	Approx. 165 g													
Polarising filter														
Housing material	Glass-fibre-reinforced plastic													

1) Average service life 100,000 h at T_A = + 25 °C

2) Provide suitable spark suppression for inductive or capacitive loads

3) With light/dark ratio 1:1

4) Reference voltage 250 V AC

5) A = V_S connections reverse-polarity protected

C = Interference pulse suppression

Operating range and operating reserve

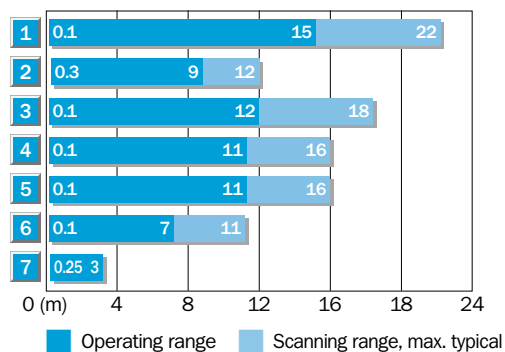

Reflector type	Operating range
1 PL 80 A	0.1...15.0 m
2 C 110	0.3...9.0 m
3 PL 50 A	0.1...12.0 m
4 PL 40 A	0.1...11.0 m
5 PL 30 A	0.1...11.0 m
6 PL 20 A	0.1...7.0 m
7 Reflective tape «Diamond Grade»	0.25...3.0 m

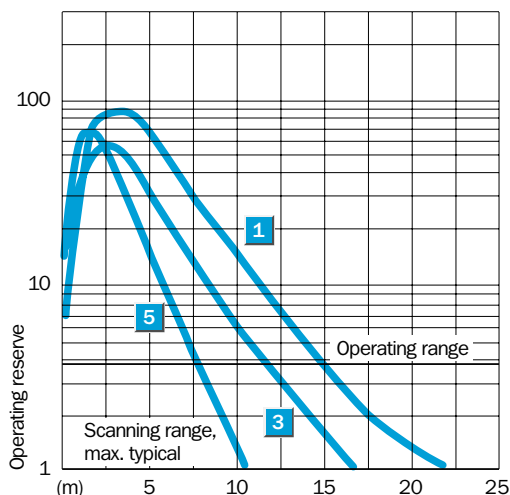

Order information

Type	Part no.
WL 36-R 230	1 005 387
WL 36-R 730	1 008 849

Scanning range
60 m

Through-beam photoelectric switches

- Robust plastic housing
- Infrared light
- Selectable time delay

Dimensional drawing

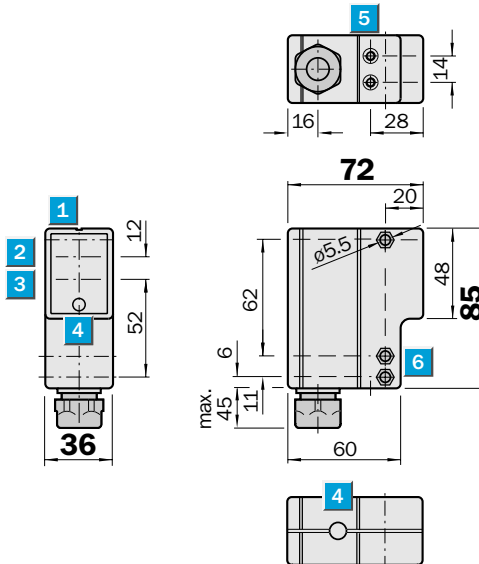

Adjustments possible

- WS/WE 36-B 230
- WS/WE 36-B 430
- WS/WE 36-B 730

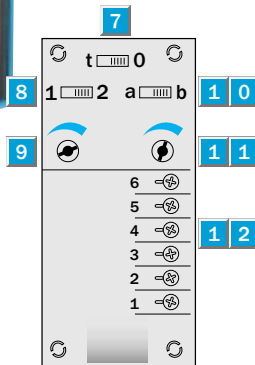

- 1** Alignment sight
- 2** Centre of optical axis, receiver
- 3** Centre of optical axis, sender
- 4** LED signal strength indicator, top and front
- 5** M5 threaded mounting hole – 5.5 mm deep
- 6** Mounting holes
recesses on both sides for M5 hex nuts
- 7** ON/OFF timer switch
t = Time ON, 0 = Time OFF
- 8** Time delay
1 ON-delay
2 OFF-delay
- 9** Time control 0.02 to 1 s
- 1 0** Light/dark selector
a = Light-switching, b = Dark-switching
- 1 1** Sensitivity adjustment
- 1 2** Terminal connections

Connection types

- WS/WE 36-B 230
- WS/WE 36-B 430
- WS/WE 36-B 730

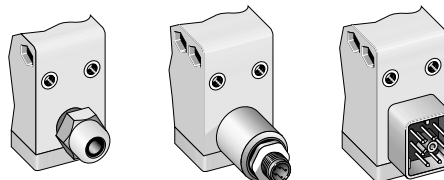

PG 11, terminals 4-pin, M 12 7-pin

Accessories	page
Cable receptacles	496
Mounting brackets	510
Attachable heated cover	556

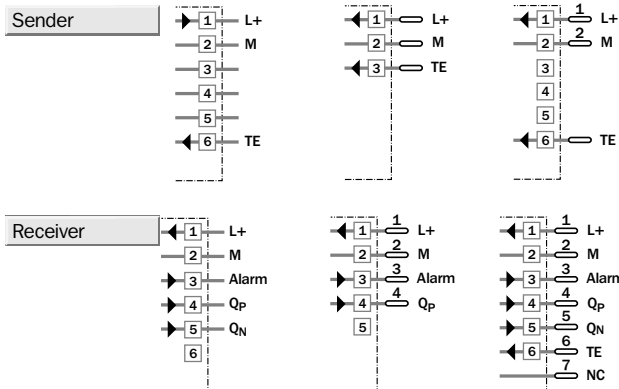

Technical data		WS/WE 36-	B 230	B 430	B 730
Scanning range , max. typical	60 m				
Sensitivity	Adjustable				
Light source¹⁾, light type	LED, infrared light				
Light spot diameter	Approx. 1300 mm at 25 m				
Supply voltage V_S	10...30 V DC ²⁾				
Ripple ³⁾	$\leq 5 V_{SS}$				
Current consumption ⁴⁾	≤ 40 mA				
Switching outputs	PNP: Q_P and NPN Q_N				
	PNP: Q_P				
Light-/dark-switching	Switch-selectable				
Output current I_A max.	200 mA				
Response time ⁵⁾	≤ 2.5 ms				
Max. switching frequency ⁶⁾	400/s				
Pre-failure signalling output	Alarm, PNP, open collector				
Internal resistance	≥ 1.5 k $\Omega \pm 5\%$				
Operating condition "correct" ⁷⁾	Output HIGH ($V_S - 1.5$ V)				
Operating condition "faulty"	Switching periodically at 5/s to V_S				
Test input "TE"	Sender switched off				
Sender OFF	Test input to 0 V				
Connection types	PG cable gland				
	Plug				
VDE protection class⁸⁾	<input type="checkbox"/>				
Circuit protection⁹⁾	A, B, C				
Enclosure rating	IP 67				
	IP 65				
Ambient temperature T_A	Operation -40 °C... +55 °C				
	Storage -40 °C... +70 °C				
Weight	Approx. 160 g				
Housing material	Glass-fibre-reinforced plastic				

- 1) Average service life 100,000 h at $T_A = +25$ °C
- 2) Limit values
- 3) May not exceed or fall short of V_S tolerances
- 4) Without load
- 5) Signal transit time with resistive load
- 6) With light/dark ratio 1:1
- 7) Signal reserve $\geq 50\%$
- 8) Reference voltage 50 V DC
- 9) A = V_S connections reverse-polarity protected
 B = Output Q_N and Q_P short-circuit protected
 C = Interference pulse suppression

Operating range and operating reserve

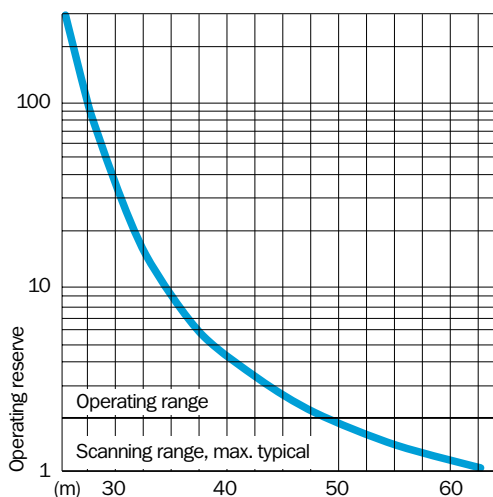
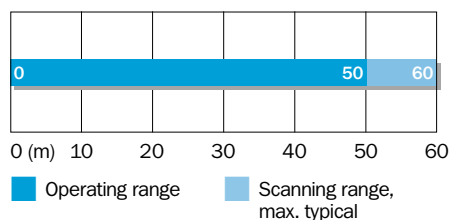

Order information

Type	Part no.
WS/WE 36-B 230	1 010 922
WS/WE 36-B 430	1 011 107
WS/WE 36-B 730	1 011 114

Scanning range
60 m

Through-beam photoelectric switches

- Robust plastic housing
- Infrared light
- Easily accessible terminal chamber
- Selectable time delay

Dimensional drawing

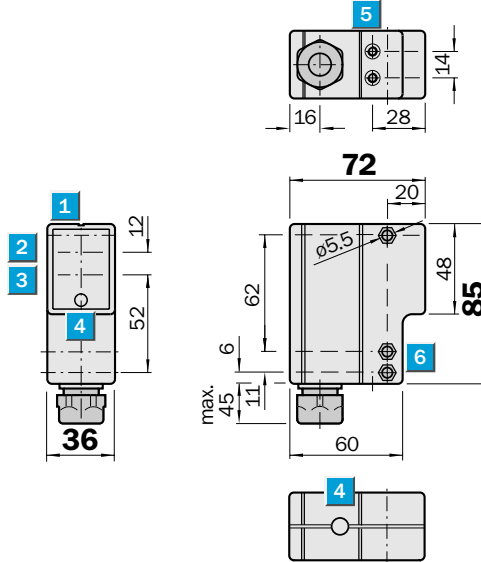

Adjustments possible

WS/WE 36-R 230
 WS/WE 36-R 730

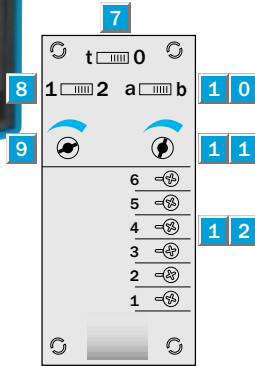

- 1 Alignment sight
- 2 Centre of optical axis, receiver
- 3 Centre of optical axis, sender
- 4 LED signal strength indicator, top and front
- 5 M 5 threaded mounting hole – 5.5 mm deep
- 6 Mounting holes
recesses on both sides for M5 hex nuts
- 7 ON/OFF timer switch
t = Time ON, 0 = Time OFF
- 8 Time delay
1 ON-delay
2 OFF-delay
- 9 Time control 0.5 to 12 s
- 1 0 Light/dark selector
a = Light-switching, b = Dark-switching
- 1 1 Sensitivity adjustment
- 1 2 Terminal connections

Connection types

WS/WE 36-R 230 WS/WE 36-R 730

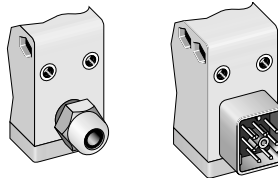

PG 11, terminals 7-pin

Accessories	page
Cable receptacles	496
Mounting brackets	510
Attachable heated cover	556

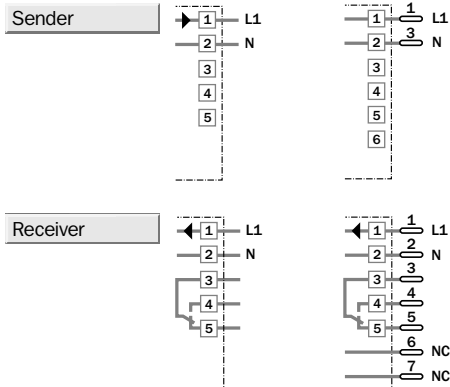

Technical data		WS/WE 36-	R 230	R 730								
Scanning range , max. typ./on reflector	60 m											
Sensitivity	Adjustable											
Light source¹⁾, light type	LED, infrared light											
Light spot diameter	Approx. 1300 mm at 25 m											
Supply voltage V_S	24...240 V UC (+ 10 %/- 25 %)											
Power consumption	< 2 VA											
Switching output	SPDT, isolated ²⁾											
Max. switching voltage	AC: 250 V / DC: 120 V											
Max. switching current	4 A / 240 V AC or 24 V DC											
Max. switching capacity	AC: 1000 VA / DC: 100 W											
Response time	≤ 20 ms											
Max. switching frequency ³⁾	10/s											
Light-/dark-switching	Switch-selectable											
Connection types	PG cable gland											
	Plug											
VDE protection class⁴⁾	<input type="checkbox"/>											
Circuit protection⁵⁾	A, C											
Enclosure rating	IP 67											
	IP 65											
Ambient temperature T_A	Operation - 25 °C... + 55 °C											
	Storage - 40 °C... + 70 °C											
Weight	Approx. 160 g											
Housing material	Glass-fibre-reinforced plastic											

1) Average service life 100,000 h at $T_A = + 25 °C$

2) Provide suitable spark suppression for inductive or capacitive loads

3) With light/dark ratio 1:1

4) Reference voltage 250 V AC

5) A = V_S connections reverse-polarity protected

C = Interference pulse suppression

Operating range and operating reserve

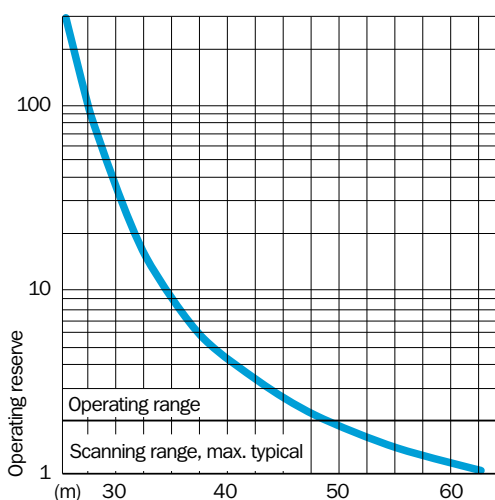
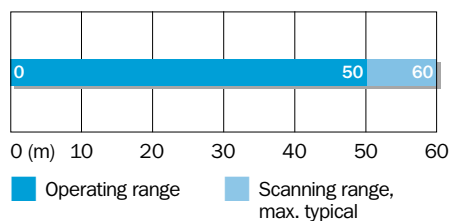

Order information

Type	Part no.
WS/WE 36-R 230	1 010 978
WS/WE 36-R 730	1 010 980