

# WF next: Fork sensors for a wide range of applications

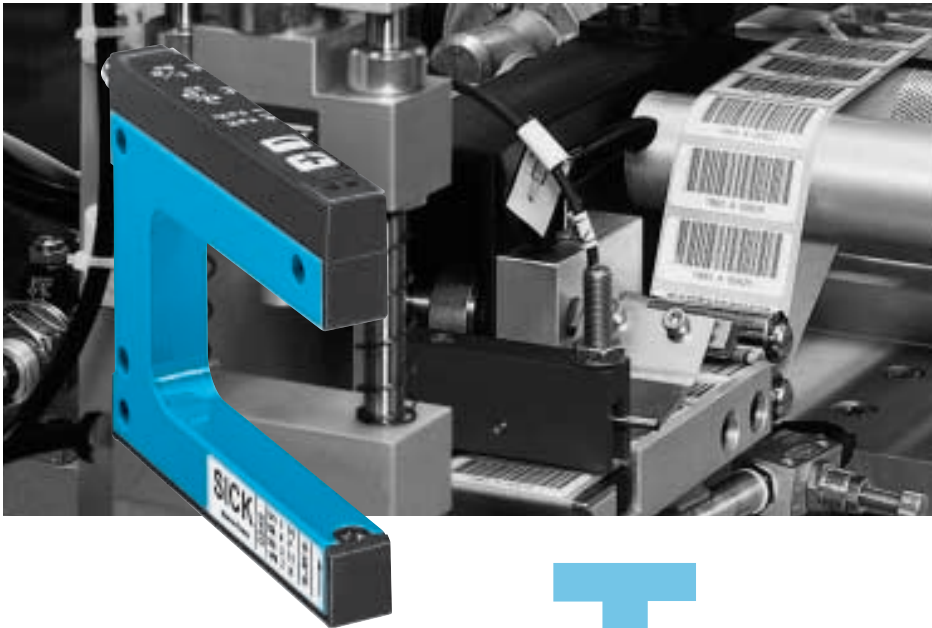

- slot widths between 2 and 120 mm, slot depths of 40, 60 and 95 mm,
- manual adjustment via user-friendly keyboard,
- simple and quick adjustment via Teach-in,
- switching output PNP and NPN,
- L/D adjustable via button,
- rugged metal housing with glass optics,
- shortest response time,
- fine resolution.

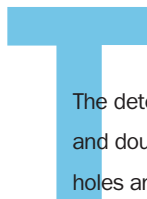
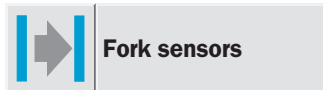

The detection of labels, marks and double sheets, as well as holes and edges are typical applications for the new WF fork sensors.

A complete range of sensors with the following features is available for a variety of operating conditions:



**Fork width**  
2 ... 120 mm

**Fork sensors**

- Simple and accurate adjustment via “+” and “-” buttons
- PNP and NPN switching output
- Light/dark switching, adjustable
- Rugged aluminium housing

**Dimensional drawing**

All types

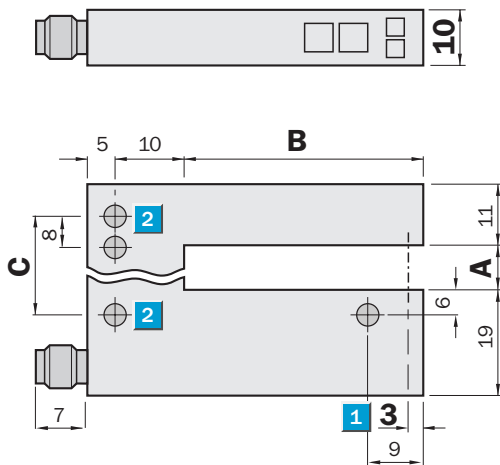

**Adjustments possible**

All types

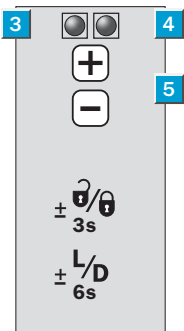

- 1 Optical axis
- 2 Mounting holes, Ø 4.2 mm
- 3 Function indicator (red)
- 4 Function indicator (yellow), switching output
- 5 “+”/“-” buttons and function button

**Dimensions**

Dimensions (mm)	A	B	C
	Fork width	Fork depth	
WF 2	2	42/59/95	14
WF 5	5	42/59/95	14
WF 15	15	42/59/95	27
WF 30	30	42/59/95	42
WF 50	50	42/59/95	40
WF 80	80	42/59/95	70
WF 120	120	42/59/95	110

**Connection types**

All types

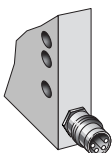

4-pin, M8

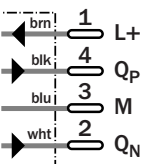

**Accessories**

Cables and Connectors

Technical data		WF	2-XX <sup>1)</sup> B410	5-XX <sup>1)</sup> B410	15-XX <sup>1)</sup> B410	30-XX <sup>1)</sup> B410	50-XX <sup>1)</sup> B410	80-XX <sup>1)</sup> B410	120-XX <sup>1)</sup> B410			
<b>Fork width</b>	2 mm											
	5 mm											
	15 mm											
	30 mm											
	50 mm											
	80 mm											
	120 mm											
<b>Fork depth</b>	40, 60 or 95 mm											
<b>Light source</b>	LED, infra-red modulated											
<b>Minimum detectable object size</b>	0.2 mm											
<b>Supply voltage U<sub>V</sub></b>	10 ... 30 V DC <sup>2)</sup>											
Current consumption <sup>3)</sup>	40 mA											
Residual ripple <sup>4)</sup>	< 10 %											
<b>Switching output</b>	PNP and NPN											
	Light/dark adjustable via button											
Signal voltage												
PNP	HIGH = U <sub>V</sub> - (< 2 V)/LOW = 0 V											
NPN	HIGH = U <sub>V</sub> /LOW = < 2 V											
Output current I <sub>A</sub>	100 mA											
Stability of response time <sup>5)</sup>	± 20 μs											
Response time <sup>5)</sup> , switching frequency <sup>6)</sup>	Max. 100 μs; 10,000/s											
Initialisation time	100 ms											
<b>Ambient light safety</b>												
Incandescent lamp	5,000 Lux											
Sunlight	10,000 Lux											
<b>VDE protection class <sup>7)</sup></b>	III											
<b>Enclosure rating</b>	IP 65											
<b>Circuit protection <sup>8)</sup></b>	A, B, C											
<b>Ambient temperature <sup>9)</sup></b>	Operation -20 °C ... +60 °C											
	Storage -30 °C ... +80 °C											
<b>Housing</b>	Aluminium											
<b>Weight</b>	Approx. 36 g to 160 g <sup>10)</sup>											

1) XX = Fork depth (Eg. 40 = fork depth equivalent to 40 mm)  
 2) Limit values, reverse-polarity protected  
 3) Without load

4) May not exceed or fall short of V<sub>S</sub>-tolerances  
 5) Signal transit time with resistive load  
 6) With light/dark ratio 1:1; no time delay  
 7) Reference voltage 50 V DC

8) A = U<sub>V</sub> connections reverse-polarity protected  
 B = Outputs short-circuit protected  
 C = Interference pulse suppression  
 9) Do not bend below 0 °C

10) Depending on fork width

**Truth table**

Switching type	Light-switching (Q)		Dark-switching (Q̄)	
	yes	no	yes	no
<b>Light path free</b>	yes	no	yes	no
<b>PNP/NPN output</b>	HIGH	LOW	LOW	HIGH
<b>Function indicator (yellow) On</b>	Off	Off	Off	On

**Order information**

Fork depth 40 mm		Fork depth 60 mm		Fork depth 95 mm	
Type	Part no.	Type	Part no.	Type	Part no.
WF2-40B410	6 028 428	WF2-60B410	6 028 436	WF2-95B410	6 028 443
WF5-40B410	6 028 429	WF5-60B410	6 028 437	WF5-95B410	6 028 444
WF15-40B410	6 028 430	WF15-60B410	6 028 438	WF15-95B410	6 028 445
WF30-40B410	6 028 431	WF30-60B410	6 028 439	WF30-95B410	6 028 446
WF50-40B410	6 028 432	WF50-60B410	6 028 440	WF50-95B410	6 028 447
WF80-40B410	6 028 433	WF80-60B410	6 028 441	WF80-95B410	6 028 448
WF120-40B410	6 028 435	WF120-60B410	6 028 442	WF120-95B410	6 028 449

**Fork width**  
2 ... 120 mm

**Fork sensors**

- Simple setting using 2-point Teach-in
- PNP and NPN switching output
- Light/dark switching adjustable
- Rugged aluminium housing

**Dimensional drawing**

All types

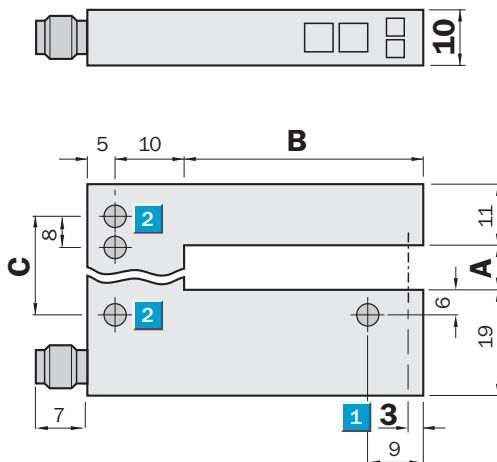

**Adjustments possible**

All types

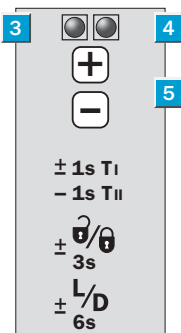

- 1 Optical axis
- 2 Mounting holes, Ø 4.2 mm
- 3 Function indicator (red)
- 4 Function indicator (yellow), switching output
- 5 "+"/"- buttons and function button

**Dimensions**

Dimensions (mm)	A	B	C
	Fork width	Fork depth	
WF 2	2	42/59/95	14
WF 5	5	42/59/95	14
WF 15	15	42/59/95	27
WF 30	30	42/59/95	42
WF 50	50	42/59/95	40
WF 80	80	42/59/95	70
WF 120	120	42/59/95	110

**Connection types**

All types

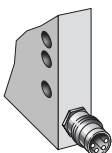

4-pin, M8

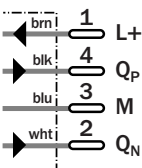

**Accessories**

Cables and Connectors

Technical data		WF	2-XX <sup>1)</sup> B416	5-XX <sup>1)</sup> B416	15-XX <sup>1)</sup> B416	30-XX <sup>1)</sup> B416	50-XX <sup>1)</sup> B416	80-XX <sup>1)</sup> B416	120-XX <sup>1)</sup> B416			
<b>Fork width</b>	2 mm											
	5 mm											
	15 mm											
	30 mm											
	50 mm											
	80 mm											
	120 mm											
<b>Fork depth</b>	40, 60 or 95 mm											
<b>Light source</b>	LED, infra-red modulated											
<b>Minimum detectable object size</b>	0.2 mm											
<b>Supply voltage U<sub>V</sub></b>	10 ... 30 V DC <sup>2)</sup>											
Current consumption <sup>3)</sup>	40 mA											
Ripple <sup>4)</sup>	< 10 %											
<b>Switching output</b>	PNP and NPN											
	Light/dark adjustable via button											
Signal voltage												
PNP	HIGH = U <sub>V</sub> - (< 2 V)/LOW = 0 V											
NPN	HIGH = U <sub>V</sub> /LOW = < 2 V											
Output current I <sub>A</sub>	100 mA											
Stability of response time <sup>5)</sup>	± 20 μs											
Response time <sup>5)</sup> , switching frequency <sup>6)</sup>	Max. 100 μs; 10,000/s											
Teach-in via button												
Initialisation time	100 ms											
<b>Ambient light safety</b>												
Incandescent lamp	5,000 Lux											
Sunlight	10,000 Lux											
<b>VDE protection class<sup>7)</sup></b>	III											
<b>Enclosure rating</b>	IP 65											
<b>Circuit protection<sup>8)</sup></b>	A, B, C											
<b>Ambient temperature<sup>9)</sup></b>	Operation	-20 °C ... +60 °C										
	Storage	-30 °C ... +80 °C										
<b>Housing</b>	Aluminium											
<b>Weight</b>	Approx. 36 g to 160 g <sup>10)</sup>											

<sup>1)</sup> XX = Fork depth (E.g. 40 = fork depth equivalent to 40 mm)  
<sup>2)</sup> Limit values, reverse-polarity protected  
<sup>3)</sup> Without load  
<sup>4)</sup> May not exceed or fall short of V<sub>S</sub>-tolerances  
<sup>5)</sup> Signal transit time with resistive load  
<sup>6)</sup> With light/dark ratio 1:1; no time delay  
<sup>7)</sup> Reference voltage 50 V DC  
<sup>8)</sup> A = U<sub>V</sub> connections reverse-polarity protected  
B = Outputs short-circuit protected  
C = Interference pulse suppression  
<sup>9)</sup> Do not bend below 0 °C  
<sup>10)</sup> Depending on fork width

**Truth table**

Switching type	Light-switching (Q)		Dark-switching (Q̄)	
	yes	no	yes	no
<b>Light path free</b>	yes	no	yes	no
<b>PNP/NPN output</b>	HIGH	LOW	LOW	HIGH
<b>Function indicator (yellow) On</b>	Off	Off	Off	On

**Order information**

Fork depth 40 mm		Fork depth 60 mm		Fork depth 95 mm	
Type	Part no.	Type	Part no.	Type	Part no.
WF2-40B416	6 028 450	WF2-60B416	6 028 457	WF2-95B416	6 028 464
WF5-40B416	6 028 451	WF5-60B416	6 028 458	WF5-95B416	6 028 465
WF15-40B416	6 028 452	WF15-60B416	6 028 459	WF15-95B416	6 028 466
WF30-40B416	6 028 453	WF30-60B416	6 028 460	WF30-95B416	6 028 467
WF50-40B416	6 028 454	WF50-60B416	6 028 461	WF50-95B416	6 028 468
WF80-40B416	6 028 455	WF80-60B416	6 028 462	WF80-95B416	6 028 469
WF120-40B416	6 028 456	WF120-60B416	6 028 463	WF120-95B416	6 028 470

## Teach-in: adjusting the switching threshold

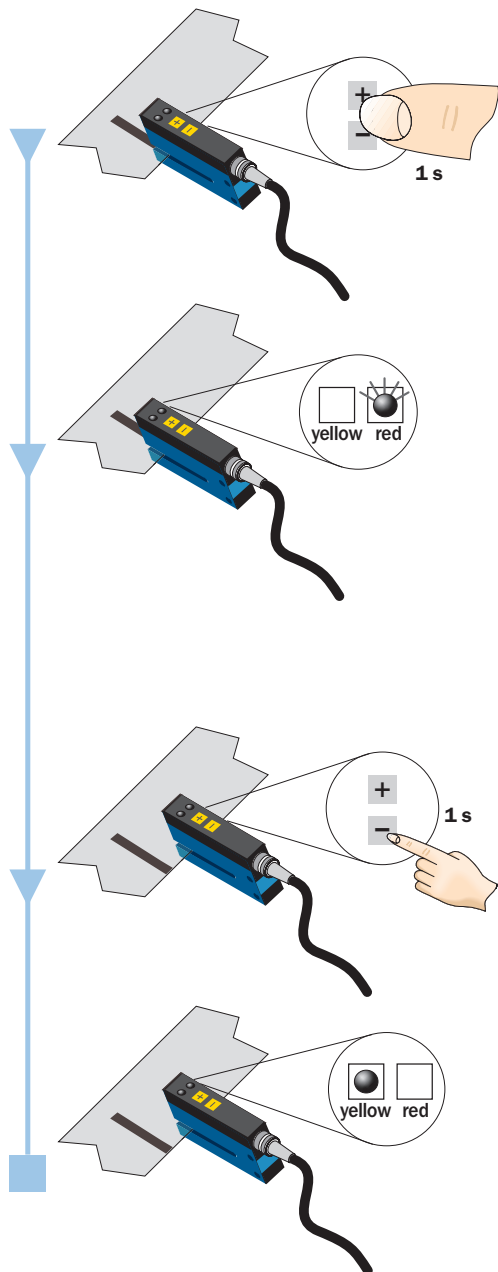

- The material speed during Teach-in must equal zero (machine stationary).

### 1<sup>st</sup> operation

- Operate both buttons for 1 sec (on mark or object).
- After the first Teach-in operation, the red function indicator flashes slowly and signals that the second Teach-in operation must now be initiated.

### 2<sup>nd</sup> operation

- Briefly operate the “-” button (on carrier material or without scanned object).
- After the second Teach-in operation, the red function indicator extinguishes.
- The Teach-in operation was unsuccessful if the red function indicator flashes.

### Notes

- **+** Following completion of the Teach-in operation, the switching threshold can be further adjusted by the “+” or “-” button at any time. For slower adjustment, press the “+” or “-” button once. For faster adjustment, the finger remains on the “+” or “-” button.
- $\pm \frac{2}{3s}$  By simultaneously pressing the “+” and “-” buttons (3 seconds), the unit can be locked against unintentional adjustment
- $\pm \frac{L/D}{6s}$  By simultaneously pressing the “+” and “-” buttons (6 seconds), the switching function (light/dark) can be inverted. Default setting: light switching.

Dimensional drawings and order information

SENSICK screw-in system M8, 4-pin, enclosure rating IP 67

Female connector M8, 4-pin, straight

Type	Part no.
DOS-0804-G	6 009 974

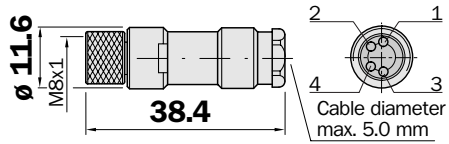

Female connector M8, 4-pin, right angle

Type	Part no.
DOS-0804-W	6 009 975

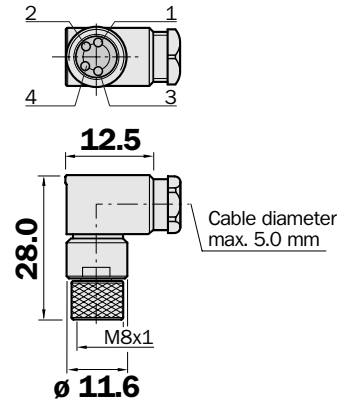

Female connector M8, 4-pin, straight

Cable diameter 5 mm, 4 x 0.25 mm<sup>2</sup>, sheath PVC

Type	Part no.	Cable length
DOL-0804-G02M	6 009 870	2 m
DOL-0804-G05M	6 009 872	5 m
DOL-0804-G10M	6 010 754	10 m

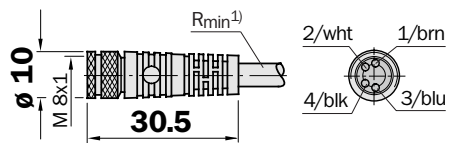

Female connector M8, 4-pin, right angle

Cable diameter 5 mm, 4 x 0.25 mm<sup>2</sup>, sheath PVC

Type	Part no.	Cable length
DOL-0804-W02M	6 009 871	2 m
DOL-0804-W05M	6 009 873	5 m
DOL-0804-W10M	6 010 755	10 m

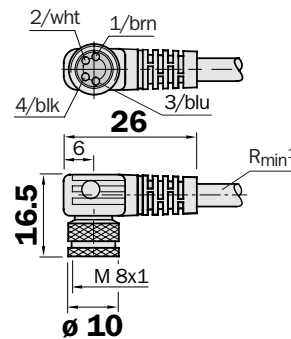

<sup>1)</sup> Minimum bend radius in dynamic use  
R<sub>min</sub> = 20 x cable diameter

Contact:

**Australia**

Phone +61 3 9497 4100  
1800 33 48 02 – tollfree  
E-Mail sales@sick.com.au

**Belgique / Luxembourg**

Phone +32 (0)2 466 55 66  
E-Mail info@sick.be

**Brazil**

Phone +55 11 5091-4900  
E-Mail sac@sick.com.br

**Česká Republika**

Phone +420 2 57 91 18 50  
E-Mail sick@sick.cz

**China**

Phone +852-2763 6966  
E-Mail ghk@sick.com.hk

**Danmark**

Phone +45 45 82 64 00  
E-Mail sick@sick.dk

**Deutschland**

Phone +49 (0)2 11 53 01-250  
E-Mail vzdinfo@sick.de

**España**

Phone +34 93 480 31 00  
E-Mail info@sick.es

**France**

Phone +33 1 64 62 35 00  
E-Mail info@sick.fr

**Great Britain**

Phone +44 (0)1727 831121  
E-Mail info@sick.co.uk

**Italia**

Phone +39 02 27 40 93 19  
E-Mail ced@sick.it

**Japan**

Phone +81 (0)3 3358 1341  
E-Mail info@sick.jp

**Korea**

Phone +82-2 786 6321/4  
E-Mail kang@sickkorea.net

**Nederland**

Phone +31 (0)30 229 25 44  
E-Mail info@sick.nl

**Norge**

Phone +47 67 81 50 00  
E-Mail auste fjord@sick.no

**Österreich**

Phone +43 (0)22 36 62 28 8-0  
E-Mail office@sick.at

**Polska**

Phone +48 22 837 40 50  
E-Mail info@sick.pl

**Schweiz**

Phone +41 41 619 29 39  
E-Mail contact@sick.ch

**Singapore**

Phone +65 6744 3732  
E-Mail admin@sicksgp.com.sg

**Suomi**

Phone +358-9-25 15 800  
E-Mail sick@sick.fi

**Sverige**

Phone +46 8 680 64 50  
E-Mail info@sick.se

**Taiwan**

Phone +886 2 2365-6292  
E-Mail sickgrc@ms6.hinet.net

**USA / Canada / Mexico**

Phone +1(952) 941-6780  
1 800-325-7425 – tollfree  
E-Mail info@sickusa.com

More representatives and agencies  
in all major industrial nations at  
[www.sick.com](http://www.sick.com)

SICK AG • Industrial Sensors • Waldkirch • Germany • [www.sick.com](http://www.sick.com)