

Micro-Change® (M12) Moulded Connectors



Male Connector



- 1 Brown
- 3 Blue
- 4 Black

5 Pole/3 Wire



- 1 Brown
- 2 White
- 3 Blue
- 4 Black

5 Pole/4 Wire



- 1 Brown
- 2 White
- 3 Blue
- 4 Black
- 5 Grey

5 Pole/5 Wire



- 1 White
- 2 Brown
- 3 Green
- 4 Yellow
- 5 Grey
- 6 Pink
- 7 Blue
- 8 Red

8 Pole

Cable Length (m)

WIRING CONFIGURATION

WIRING CONFIGURATION

Micro-Change® (M12) Straight



Material	Cable Length (m)	WIRING CONFIGURATION			
		5 Pole/3 Wire	5 Pole/4 Wire	5 Pole/5 Wire	
PVC	2.0	803006E03M020	804006E03M020	805006E03M020	
	5.0	803006E03M050	804006E03M050	805006E03M050	
	10.0	803006E03M100	804006E03M100	805006E03M100	
PUR	2.0	803006P03M020	804006P03M020	805006P03M020	808006P02M020
	5.0	803006P03M050	804006P03M050	805006P03M050	808006P02M050
	10.0	803006P03M100	804006P03M100	805006P03M100	808006P02M100
SJTO	2.0	803006S20M020	804006S20M020	805006S26M020	
	5.0	803006S20M050	804006S20M050	805006S26M050	
	10.0	803006S20M100	804006S20M100	805006S26M100	

Micro-Change® (M12) 90°

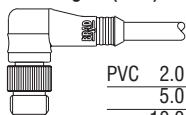

Material	Cable Length (m)	WIRING CONFIGURATION			
		5 Pole/3 Wire	5 Pole/4 Wire	5 Pole/5 Wire	
PVC	2.0	803007E03M020	804007E03M020	805007E03M020	
	5.0	803007E03M050	804007E03M050	805007E03M050	
	10.0	803007E03M100	804007E03M100	805007E03M100	
PUR	2.0	803007P03M020	804007P03M020	805007P03M020	808007P02M020
	5.0	803007P03M050	804007P03M050	805007P03M050	808007P02M050
	10.0	803007P03M100	804007P03M100	805007P03M100	808007P02M100
SJTO	2.0	803007S20M020	804007S20M020	805007S26M020	
	5.0	803007S20M050	804007S20M050	805007S26M050	
	10.0	803007S20M100	804007S20M100	805007S26M100	

Micro-Change® (M12) Field Attachable Connectors

Female Attachables

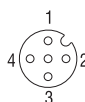

- 1 Brown
- 2 White
- 3 Blue
- 4 Black

4 Pole

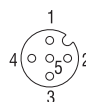

- 1 Brown
- 2 White
- 3 Blue
- 4 Black
- 5 Grey

5 Pole

WIRING CONFIGURATION

Micro-Change® (M12) Straight

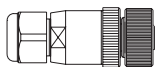

Gland size	4 Pole	5 Pole
PG7	8A4000-315	8A5000-315
PG9	8A4000-325	8A5000-325

Micro-Change® (M12) 90°

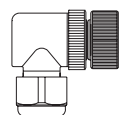

Gland size	4 Pole	5 Pole
PG7	8A4001-315	8A5001-315

Male Attachable



- 1 Brown
- 2 White
- 3 Blue
- 4 Black

4 Pole

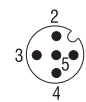

- 1 Brown
- 2 White
- 3 Blue
- 4 Black
- 5 Grey

5 Pole

WIRING CONFIGURATION

Micro-Change® (M12) Straight

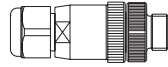

Gland size	4 Pole	5 Pole
PG7	8A4006-315	8A5006-315
PG9	8A4006-325	8A5006-325

Micro-Change® (M12) 90°

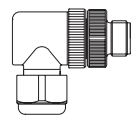

Gland size	4 Pole	5 Pole
PG7	8A4007-315	8A5007-315

MICRO-CHANGE '8A' SERIES RE-WIREABLE CONNECTOR

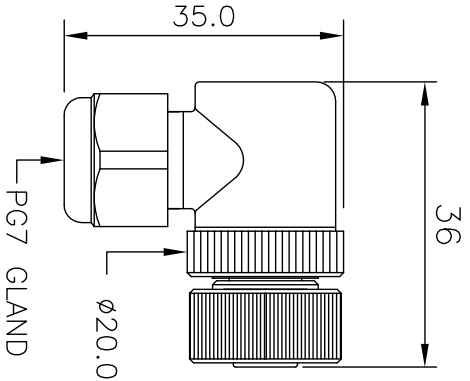

Revision	CN Number	Date	By	App'd

Revision	CN Number	Date	By	App'd

Revision	CN Number	Date	By	App'd
A	First Issue	23.09.97	TD	AB

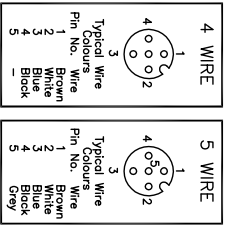

PG7 CABLE GLAND WILL ACCOMMODATE
CABLE DIAMETERS FROM :
2.5mm TO 6.5mm
WITH A MAXIMUM WIRE
GAUGE OF 0.75mm²

PART NO MATRIX

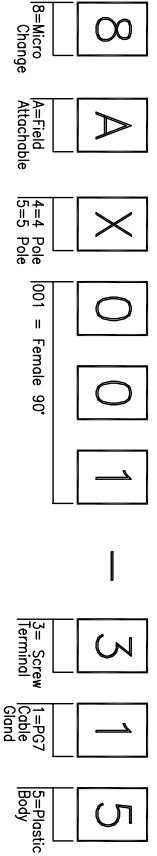

Modifications must be carried out using CAD System
3rd ANGLE PROJECTION

FOR EXPLANATION OF DIMENSIONS, TOLERANCES, NOTES etc. SEE BS308

Woodhead Connectivity Ltd
FACTORY 9 PASSAU IND. EST. EBW WALE CEMENT NP23 580

DRAWN	TD	REV.
DATE	23.09.97	A