

### Slim, Miniature Relay, Capable of Relaying Programmable Controller and Temperature Controller Outputs

- ROHS compliant.
- Slim and miniature: 17.5 x 6.5 x 12.5 mm (L x W x H).
- Ideal for high-density mounting
- Switches 5 A at 250 VAC/30 VDC.
- Allows 300,000 operations with a 2-A load at 250 VAC or 30 VDC.
- Actual load switching capability equals the G6B's capability.
- Washable construction.

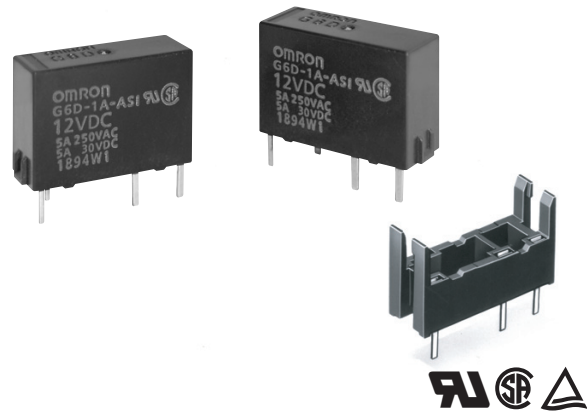

Power Relays

### Ordering Information

Classification	Contact form	Enclosure ratings	Model
Standard	SPST-NO	Fully sealed	G6D-1A-ASI

**Note:** When ordering, add the rated coil voltage to the model number.

Example: G6D-1A-ASI 12 VDC  
└───┘ Rated coil voltage

#### Model Number Legend

G6D -       -       VDC  
           1   2   3   4

- |   |  |
|---|--|
| <p><b>1. Number of Poles</b><br/>1: 1 pole</p> <p><b>2. Contact Form</b><br/>A: SPST-NO</p> | <p><b>3. Contact Material</b><br/>ASI: Silver alloy (cadmium-free)</p> <p><b>4. Rated Coil Voltage</b><br/>5, 12, 24 VDC</p> |
|---|--|

### ■ Accessories (Order Separately)

Connecting Socket	P6D-04P
-------------------	---------

## Specifications

### ■ Coil Ratings

Rated voltage	5 VDC	12 VDC	24 VDC
Rated current	40 mA	16.7 mA	8.3 mA
Coil resistance	125 Ω	720 Ω	2,880 Ω
Must operate voltage	70% max. of rated voltage		
Must release voltage	10% min. of rated voltage		
Max. voltage	160% of rated voltage (at 23°C)		
Power consumption	Approx. 200 mW		

Note: The must operate voltage is 75% or less of the rated voltage if the relay is mounted upside down.

### ■ Contact Ratings

Rated load	5 A at 250 VAC, 5 A at 30 VDC, resistive load
Contact material	AgSnIn
Rated carry current	5 A
Max. switching voltage	250 VAC, 30 VDC
Max. switching current	5 A
Max. switching power	1,250 VA, 150 W
Failure rate (reference value)	10 mA at 5 VDC

Note: P level:  $\lambda_{60} = 0.1 \times 10^{-6}$ /operation.

### ■ Characteristics

Contact resistance	100 mΩ max.	
Operate time	10 ms max.	
Release time	5 ms max.	
Insulation resistance	1,000 MΩ min. (at 500 VDC)	
Dielectric strength	3,000 VAC, 50/60 Hz for 1 min between coil and contacts 750 VAC, 50/60 Hz for 1 min between contacts of same polarity	
Impulse withstand voltage	G6B 6KV 1.2*50μsec	
Insulation Distance	Creepage (Typ)	4.5 mm
	Clearance (Typ)	4.5 mm
Tracking Resistance CTI)	100 V	
Vibration resistance	Destruction: 10 to 55 to 10 Hz, 0.75-mm single amplitude (1.5-mm double amplitude) Malfunction: 10 to 55 to 10 Hz, 0.75-mm single amplitude (1.5-mm double amplitude)	
Shock resistance	Destruction: 1,000 m/s <sup>2</sup> Malfunction: Energized: 100 m/s <sup>2</sup>	
Endurance	Mechanical: 20,000,000 operations min. (at 18,000 operations/hr) Electrical: 70,000 operations min. (5 A at 250 VAC/30 VDC, resistive load) 300,000 operations min. (2 A at 250 VAC/30 VDC, resistive load)	
Ambient temperature	Operating: -25°C to 70°C (with no icing)	
Ambient humidity	Operating: 5% to 85%	
Weight	Approx. 3 g	

Engineering Data

Maximum Switching Power

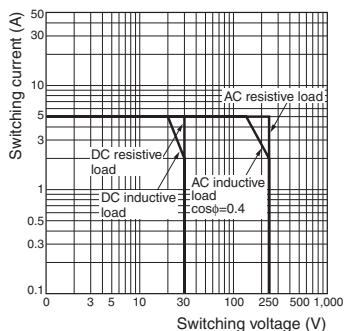

Endurance

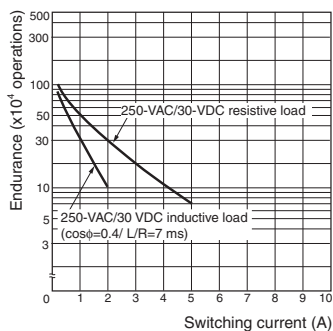

Ambient Temperature vs. Maximum Coil Voltage

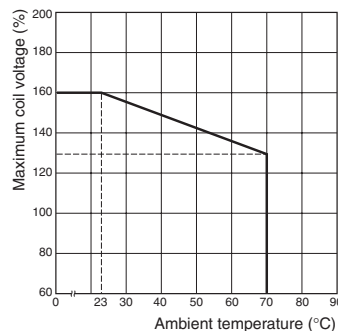

**Note:** The maximum coil voltage is the maximum voltage that can be applied to the relay coil

Ambient Temperature vs. Operating/Recovery Voltage G6D-1A-ASI

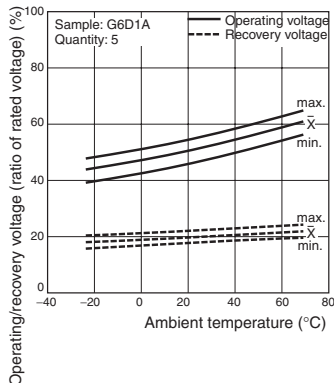

Malfunctioning Shock G6D-1A-ASI

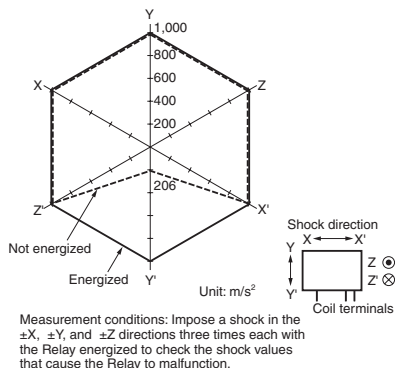

Approved Standards

The rated values approved by each of the safety standards may be different from the performance characteristics individually defined in this catalogue.

UL Approval (File No. E41515) UL508

Model	Number of poles	Coil ratings	Contact Ratings	Number of test operations
G6D-1A-ASI	1	5 to 24 VDC	5 A, 250 VAC (General Use)	6,000
			5 A, 30 VDC	

CSA Approval (File No. LR31928) C22.2 No. 14

Model	Number of poles	Coil ratings	Contact Ratings	Number of test operations
G6D-1A-ASI	1	5 to 24 VDC	5 A, 250 VAC (General Use)	6,000
			5 A, 30 VDC (Resistive)	

EN/TÜV Approval (Registration No. R50029064/EN61810-1)

Model	Number of poles	Coil ratings	Contact Ratings	Number of test operations
G6D-1A-ASI	1	5, 12, 24 VDC	5 A, 250 VAC (cosφ=1.0)	70,000
			5 A, 30 VDC (0 ms)	

# Dimensions

**Note: 1.** All units are in millimeters unless otherwise indicated.

**2.** Orientation marks are indicated as follows:  

## G6D-1A-ASI

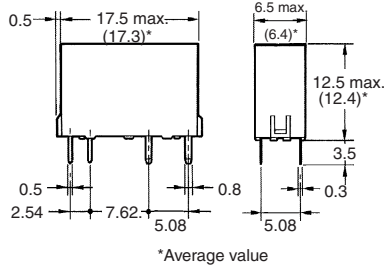
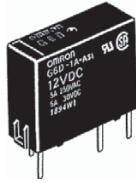

## Terminal Arrangement/ Internal Connections (Bottom View)

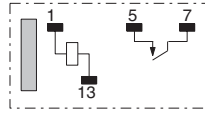

## Mounting Holes (Bottom View)

Tolerance:  $\pm 0.1$

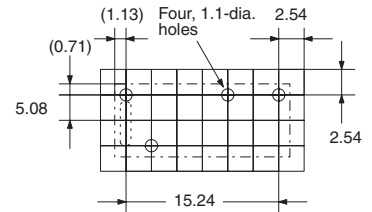

## P6D-04P Socket

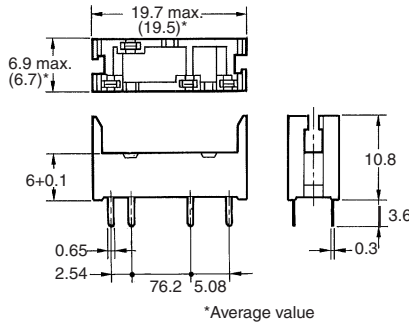
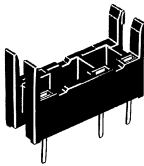

## Mounting Holes (Bottom View)

Tolerance:  $\pm 0.1$

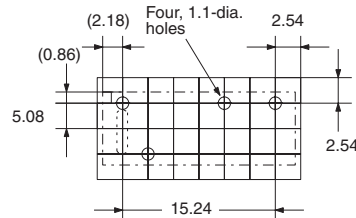

# Precautions

More than two relays can be closely mounted right side up as shown in the following illustration.

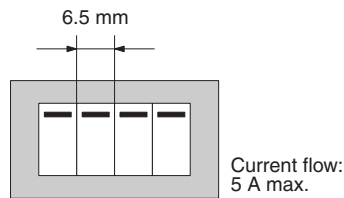

More than two relays can be closely mounted upside down as shown in the following illustration.

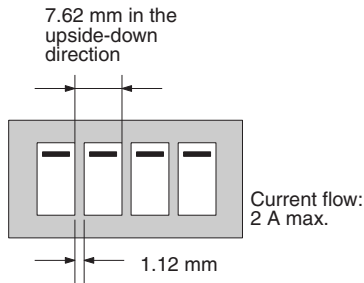

**Note:** The space between each relay required for heat radiation may vary with operating conditions. Contact your OMRON representative for details

## SOCKET MOUNTING HEIGHT

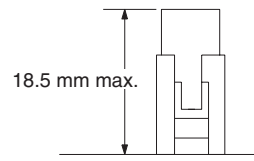

When mounting the relay, insert it into the socket as vertically as possible so that the relay terminals contact securely with the contact pins on the socket.

The P6D is flux-resistant. Do not wash the P6D with water.

Dismount the relay from the socket before soldering the socket to a PCB.

**ALL DIMENSIONS SHOWN ARE IN MILLIMETERS.**

To convert millimeters into inches, multiply by 0.03937. To convert grams into ounces, multiply by 0.03527.