

Reliable High Temperature Basic Switch with External Lever

- Maximum operating temperature of 200°C
- ROHS compliant.
- Available in 0.1 A, 6 A and 11 A models, all with self-cleaning contacts.
- Available with internally or externally fitted levers, and 2 fixing positions for external levers.
- Conforms to EN61058-1 and UL1054 (subjected for 11A rating).



Ordering Information

Model Number Legend

D3V-□□□□-□□□-□-□
 1 2 3 4 5 6 7 8 9

1. Ratings

- 11: 11 (3) A at 250 VAC
- 6: 6 (2) A at 250 VAC
- 01: 0.1 A at 125 VAC

2. Contact Gap

- None: 1 mm (F gap) – 11 A, 6 A and 0.1 A
- G: 0.5 mm (G gap) – 11 A and 6 A

3. Actuator

- None: Pin plunger
- 1: Short hinge lever
- 2: Hinge lever
- 3: Long hinge lever
- 4: Simulated roller lever
- 5: Short hinge roller lever
- 6: Hinge roller lever

4. Hinge Position

- None: Internal/Far from plunger
- M: External/Far from plunger
- K: External/Near plunger

5. Contact Form

- 1: SPDT
- 2: SPST-NC
- 3: SPST-NO

6. Terminals

- A: Solder/quick-connect terminal (#187)
- C2: Quick-connect terminal (#187)
- C: Quick-connect terminal (#250) – currently not available for 0.1 A type

7. Maximum Operating Force

- 5: 1.96 N {200 gf}
- 4: 0.98 N {100 gf}
- 3: 0.49 N {50 gf}

Note: These values are for the pin plunger models.

8. Special Code

- T: High temperature (200°C and 155°C)

9. Mounting Hole Size

- None: 3.1mm
- K: 2.9mm

Available Combinations

Model	D3V-11					D3V-6			D3V-01	
	11 A					6 A			0.1 A	
	1.96 N (200 gf)		0.98 N (100 gf)		0.49 N (50 gf)	1.96 N (200 gf)	0.98 N (100 gf)	0.49 N (50 gf)	0.49 N (50 gf)	
	OF									
Contact Gap	F	G	F	G	G	F/G	F	G	G	F
Heat resistance	Terminals									
High Temperature (200°C)	4.8 x 0.5	-	-	-	-	○	○	○	○	○
	6.4 x 0.8	-	-	-	-	○	○	○	○	-
High Temperature (155°C)	4.8 x 0.5	○	○	○	○	-	-	-	-	-
	6.4 x 0.8	○	○	○	○	-	-	-	-	-

Note. 1. ○ = Semi-standard
 2. Consult OMRON for models with standard approval

List of Models

11 A (OF: 1.96 N {200 gf})

Actuator	Hinge position	Contact form		
		SPDT	SPST-NC	SPST-NO
Pin plunger	-	D3V-11-1□5-T-△	D3V-11-2□5-T-△	D3V-11-3□5-T-△
Short hinge lever	Internal	D3V-111-1□5-T-△	D3V-111-2□5-T-△	D3V-111-3□5-T-△
	M	D3V-111M-1□5-T-△	D3V-111M-2□5-T-△	D3V-111M-3□5-T-△
Hinge lever	Internal	D3V-112-1□5-T-△	D3V-112-2□5-T-△	D3V-112-3□5-T-△
	M	D3V-112M-1□5-T-△	D3V-112M-2□5-T-△	D3V-112M-3□5-T-△
Long hinge lever	Internal	D3V-113-1□5-T-△	D3V-113-2□5-T-△	D3V-113-3□5-T-△
	M	D3V-113M-1□5-T-△	D3V-113M-2□5-T-△	D3V-113M-3□5-T-△
Simulated hinge lever	Internal	D3V-114-1□5-T-△	D3V-114-2□5-T-△	D3V-114-3□5-T-△
	M	D3V-114M-1□5-T-△	D3V-114M-2□5-T-△	D3V-114M-3□5-T-△
Short hinge roller lever	Internal	D3V-115-1□5-T-△	D3V-115-2□5-T-△	D3V-115-3□5-T-△
	M	D3V-115M-1□5-T-△	D3V-115M-2□5-T-△	D3V-115M-3□5-T-△
Hinge roller lever	Internal	D3V-116-1□5-T-△	D3V-116-2□5-T-△	D3V-116-3□5-T-△
	M	D3V-116M-1□5-T-△	D3V-116M-2□5-T-△	D3V-116M-3□5-T-△

Note: The □ in the model number is for the terminal code.







- A: Solder/terminals (#187)
- C2: Quick-connect terminals (#187)
- C: Quick-connect terminals (#250)

The △ in the model number is for the mounting hole size.







- None: 3.1 mm
- K: 2.9 mm

High Temperature Miniature Basic Switch – D3V-T

11 A (OF: 0.98 N {100 gf})

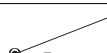
Actuator	Hinge position	Contact form		
		SPDT	SPST-NC	SPST-NO
Pin plunger 	-	D3V-11-1□4-T-△	D3V-11-2□4-T-△	D3V-11-3□4-T-△
Short hinge lever 	Internal	D3V-111-1□4-T-△	D3V-111-2□4-T-△	D3V-111-3□4-T-△
	M	D3V-111M-1□4-T-△	D3V-111M-2□4-T-△	D3V-111M-3□4-T-△
Hinge lever 	Internal	D3V-112-1□4-T-△	D3V-112-2□4-T-△	D3V-112-3□4-T-△
	M	D3V-112M-1□4-T-△	D3V-112M-2□4-T-△	D3V-112M-3□4-T-△
Long hinge lever 	Internal	D3V-113-1□4-T-△	D3V-113-2□4-T-△	D3V-113-3□4-T-△
	M	D3V-113M-1□4-T-△	D3V-113M-2□4-T-△	D3V-113M-3□4-T-△
Simulated hinge lever 	Internal	D3V-114-1□4-T-△	D3V-114-2□4-T-△	D3V-114-3□4-T-△
	M	D3V-114M-1□4-T-△	D3V-114M-2□4-T-△	D3V-114M-3□4-T-△
Short hinge roller lever 	Internal	D3V-115-1□4-T-△	D3V-115-2□4-T-△	D3V-115-3□4-T-△
	M	D3V-115M-1□4-T-△	D3V-115M-2□4-T-△	D3V-115M-3□4-T-△
Hinge roller lever 	Internal	D3V-116-1□4-T-△	D3V-116-2□4-T-△	D3V-116-3□4-T-△
	M	D3V-116M-1□4-T-△	D3V-116M-2□4-T-△	D3V-116M-3□4-T-△

11 A (OF: 0.49 N {50 gf})

Actuator	Hinge position	Contact form		
		SPDT	SPST-NC	SPST-NO
Pin plunger 	-	D3V-11G-1□3-T-△	D3V-11G-2□3-T-△	D3V-11G-3□3-T-△
Short hinge lever 	Internal	D3V-11G1-1□3-T-△	D3V-11G1-2□3-T-△	D3V-11G1-3□3-T-△
	M	D3V-11G1M-1□3-T-△	D3V-11G1M-2□3-T-△	D3V-11G1M-3□3-T-△
Hinge lever 	Internal	D3V-11G2-1□3-T-△	D3V-11G2-2□3-T-△	D3V-11G2-3□3-T-△
	M	D3V-11G2M-1□3-T-△	D3V-11G2M-2□3-T-△	D3V-11G2M-3□3-T-△
Long hinge lever 	Internal	D3V-11G3-1□3-T-△	D3V-11G3-2□3-T-△	D3V-11G3-3□3-T-△
	M	D3V-11G3M-1□3-T-△	D3V-11G3M-2□3-T-△	D3V-11G3M-3□3-T-△
Simulated hinge lever 	Internal	D3V-11G4-1□3-T-△	D3V-11G4-2□3-T-△	D3V-11G4-3□3-T-△
	M	D3V-11G4M-1□3-T-△	D3V-11G4M-2□3-T-△	D3V-11G4M-3□3-T-△
Short hinge roller lever 	Internal	D3V-11G5-1□3-T-△	D3V-11G5-2□3-T-△	D3V-11G5-3□3-T-△
	M	D3V-11G5M-1□3-T-△	D3V-11G5M-2□3-T-△	D3V-11G5M-3□3-T-△
Hinge roller lever 	Internal	D3V-11G6-1□3-T-△	D3V-11G6-2□3-T-△	D3V-11G6-3□3-T-△
	M	D3V-11G6M-1□3-T-△	D3V-11G6M-2□3-T-△	D3V-11G6M-3□3-T-△







Note: The □ in the model number is for the terminal code.

- A: Solder/terminals (#187)
- C2: Quick-connect terminals (#187)
- C: Quick-connect terminals (#250)







The △ in the model number is for the mounting hole size.

- None: 3.1 mm
- K: 2.9 mm

6 A (OF: 1.96 N {200 gf})







Actuator	Hinge position	Contact form		
		SPDT	SPST-NC	SPST-NO
Pin plunger 	-	D3V-6-1□5-T-△	D3V-6-2□5-T-△	D3V-6-3□5-T-△
Short hinge lever 	Internal	D3V-61-1□5-T-△	D3V-61-2□5-T-△	D3V-61-3□5-T-△
	M	D3V-61M-1□5-T-△	D3V-61M-2□5-T-△	D3V-61M-3□5-T-△
Hinge lever 	Internal	D3V-62-1□5-T-△	D3V-62-2□5-T-△	D3V-62-3□5-T-△
	M	D3V-62M-1□5-T-△	D3V-62M-2□5-T-△	D3V-62M-3□5-T-△
Long hinge lever 	Internal	D3V-63-1□5-T-△	D3V-63-2□5-T-△	D3V-63-3□5-T-△
	M	D3V-63M-1□5-T-△	D3V-63M-2□5-T-△	D3V-63M-3□5-T-△
Simulated hinge lever 	Internal	D3V-64-1□5-T-△	D3V-64-2□5-T-△	D3V-64-3□5-T-△
	M	D3V-64M-1□5-T-△	D3V-64M-2□5-T-△	D3V-64M-3□5-T-△
Short hinge roller lever 	Internal	D3V-65-1□5-T-△	D3V-65-2□5-T-△	D3V-65-3□5-T-△
	M	D3V-65M-1□5-T-△	D3V-65M-2□5-T-△	D3V-65M-3□5-T-△
Hinge roller lever 	Internal	D3V-66-1□5-T-△	D3V-66-2□5-T-△	D3V-66-3□5-T-△
	M	D3V-66M-1□5-T-△	D3V-66M-2□5-T-△	D3V-66M-3□5-T-△

6 A (OF: 0.98 N {100 gf})







Actuator	Hinge position	Contact form		
		SPDT	SPST-NC	SPST-NO
Pin plunger 	-	D3V-6-1□4-T-△	D3V-6-2□4-T-△	D3V-6-3□4-T-△
Short hinge lever 	Internal	D3V-61-1□4-T-△	D3V-61-2□4-T-△	D3V-61-3□4-T-△
	M	D3V-61M-1□4-T-△	D3V-61M-2□4-T-△	D3V-61M-3□4-T-△
Hinge lever 	Internal	D3V-62-1□4-T-△	D3V-62-2□4-T-△	D3V-62-3□4-T-△
	M	D3V-62M-1□4-T-△	D3V-62M-2□4-T-△	D3V-62M-3□4-T-△
Long hinge lever 	Internal	D3V-63-1□4-T-△	D3V-63-2□4-T-△	D3V-63-3□4-T-△
	M	D3V-63M-1□4-T-△	D3V-63M-2□4-T-△	D3V-63M-3□4-T-△
Simulated hinge lever 	Internal	D3V-64-1□4-T-△	D3V-64-2□4-T-△	D3V-64-3□4-T-△
	M	D3V-64M-1□4-T-△	D3V-64M-2□4-T-△	D3V-64M-3□4-T-△
Short hinge roller lever 	Internal	D3V-65-1□4-T-△	D3V-65-2□4-T-△	D3V-65-3□4-T-△
	M	D3V-65M-1□4-T-△	D3V-65M-2□4-T-△	D3V-65M-3□4-T-△
Hinge roller lever 	Internal	D3V-66-1□4-T-△	D3V-66-2□4-T-△	D3V-66-3□4-T-△
	M	D3V-66M-1□4-T-△	D3V-66M-2□4-T-△	D3V-66M-3□4-T-△

High Temperature Miniature Basic Switch – D3V-T

6 A (OF: 0.49 N {50 gf})

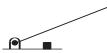
Actuator	Hinge position	Contact form		
		SPDT	SPST-NC	SPST-NO
Pin plunger 	-	D3V-6G-1□3-T-△	D3V-6G-2□3-T-△	D3V-6G-3□3-T-△
Short hinge lever 	Internal	D3V-6G1-1□3-T-△	D3V-6G1-2□3-T-△	D3V-6G1-3□3-T-△
	M	D3V-6G1M-1□3-T-△	D3V-6G1M-2□3-T-△	D3V-6G1M-3□3-T-△
Hinge lever 	Internal	D3V-6G2-1□3-T-△	D3V-6G2-2□3-T-△	D3V-6G2-3□3-T-△
	M	D3V-6G2M-1□3-T-△	D3V-6G2M-2□3-T-△	D3V-6G2M-3□3-T-△
Long hinge lever 	Internal	D3V-6G3-1□3-T-△	D3V-6G3-2□3-T-△	D3V-6G3-3□3-T-△
	M	D3V-6G3M-1□3-T-△	D3V-6G3M-2□3-T-△	D3V-6G3M-3□3-T-△
Simulated hinge lever 	Internal	D3V-6G4-1□3-T-△	D3V-6G4-2□3-T-△	D3V-6G4-3□3-T-△
	M	D3V-6G4M-1□3-T-△	D3V-6G4M-2□3-T-△	D3V-6G4M-3□3-T-△
Short hinge roller lever 	Internal	D3V-6G5-1□3-T-△	D3V-6G5-2□3-T-△	D3V-6G5-3□3-T-△
	M	D3V-6G5M-1□3-T-△	D3V-6G5M-2□3-T-△	D3V-6G5M-3□3-T-△
Hinge roller lever 	Internal	D3V-6G6-1□3-T-△	D3V-6G6-2□3-T-△	D3V-6G6-3□3-T-△
	M	D3V-6G6M-1□3-T-△	D3V-6G6M-2□3-T-△	D3V-6G6M-3□3-T-△

01 A (OF: 0.49 N {50 gf})

Actuator	Hinge position	Contact form		
		SPDT	SPST-NC	SPST-NO
Pin plunger 	-	D3V-01-1□3-T-△	D3V-01-2□3-T-△	D3V-01-3□3-T-△
Short hinge lever 	Internal	D3V-011-1□3-T-△	D3V-011-2□3-T-△	D3V-011-3□3-T-△
	M	D3V-011M-1□3-T-△	D3V-011M-2□3-T-△	D3V-011M-3□3-T-△
Hinge lever 	Internal	D3V-012-1□3-T-△	D3V-012-2□3-T-△	D3V-012-3□3-T-△
	M	D3V-012M-1□3-T-△	D3V-012M-2□3-T-△	D3V-012M-3□3-T-△
Long hinge lever 	Internal	D3V-013-1□3-T-△	D3V-013-2□3-T-△	D3V-013-3□3-T-△
	M	D3V-013M-1□3-T-△	D3V-013M-2□3-T-△	D3V-013M-3□3-T-△
Simulated hinge lever 	Internal	D3V-014-1□3-T-△	D3V-014-2□3-T-△	D3V-014-3□3-T-△
	M	D3V-014M-1□3-T-△	D3V-014M-2□3-T-△	D3V-014M-3□3-T-△
Short hinge roller lever 	Internal	D3V-015-1□3-T-△	D3V-015-2□3-T-△	D3V-015-3□3-T-△
	M	D3V-015M-1□3-T-△	D3V-015M-2□3-T-△	D3V-015M-3□3-T-△
Hinge roller lever 	Internal	D3V-016-1□3-T-△	D3V-016-2□3-T-△	D3V-016-3□3-T-△
	M	D3V-016M-1□3-T-△	D3V-016M-2□3-T-△	D3V-016M-3□3-T-△

Note: The □ in the model number is for the terminal code.

- A: Solder/terminals (#187)
- C2: Quick-connect terminals (#187)
- C: Quick-connect terminals (#250)

The △ in the model number is for the mounting hole size.

- None: 3.1 mm
- K: 2.9 mm

Specifications

■ Ratings

Type	Rated voltage	Non-inductive load				Inductive load			
		Resistive load		Lamp load		Inductive load		Motor load	
		NC	NO	NC	NO	NC	NO	NC	NO
D3V-11	250 VAC	11 A		1.5 A		6 A		2 A	
	8 VDC	11 A		3 A		6 A		3 A	
	30 VDC	6 A		3 A		6 A		3 A	
	125 VDC	0.6 A		0.1 A		0.6 A		0.1 A	
	250 VDC	0.3 A		0.05 A		0.3 A		0.05 A	
D3V-6	250 VAC	6 A		3 A		4 A		–	
	8 VDC	6 A		3 A		4 A		–	
	30 VDC	6 A		3 A		4 A		–	
	125 VDC	0.4 A		0.1 A		0.4 A		–	
	250 VDC	0.3 A		0.05 A		0.2 A		–	
D3V-01	125 VAC	0.1 A		–		–		–	
	8 VDC	0.1 A		–		–		–	
	30 VDC	0.1 A		–		–		–	

- Note:**
- The above current values are the normal current values of models with a contact gap of 1 mm (gap F), which vary with the normal current values of models with a contact gap of 0.5 mm (gap G).
 - Inductive load has a power factor of 0.4 min. (AC) and a time constant of 7 ms max. (DC).
 - Lamp load has an inrush current of 10 times the steady-state current.
 - Motor load has an inrush current of 6 times the steady-state current.
 - The ratings values apply under the following test conditions:
 Ambient temperature: 20±2°C
 Ambient humidity: 65±5%
 Operating frequency: 30 operations/min

■ Characteristics

Operating speed	0.1 mm to 1 m/s (at pin plunger models)
Operating frequency	Mechanical: 600 operations/min Electrical: 60 operations/min
Insulation resistance	100 MΩ min. (at 500 VDC)
Contact resistance (initial values)	D3V-11, D3V-6: 30 mΩ max. D3V-01 {50 gf}: 50 mΩ max
Dielectric strength (see note 1)	1,000 VAC, 50/60 Hz for 1 min between terminals of the same polarity 2,000 VAC, 50/60 Hz for 1 min between current-carrying metal parts and ground, and between each terminal and non-current-carrying metal parts
Vibration resistance (see note 2)	Malfunction: 10 to 55 Hz, 1.5mm double amplitude
Shock resistance (see note 2)	Destruction: 400 m/s ² {approx. 40G} max. Malfunction: 100 m/s ² {approx. 10G} max.
Durability (see note 3)	Mechanical: 10,000,000 operations min. Electrical: D3V-11: 100,000 operations min. D3V-6, D3V-01: 100,000 operations min.
Degree of protection	IP40
Degree of protection against electric shock	Class I
Proof tracking index (PTI)	175
Ambient operating temperature	D3V-11: -25°C to 155°C (with no icing) D3V-6, D3V-01: -25°C to 200°C (with no icing)
Ambient operating humidity	85% max. (for 5°C to 35°C)
Weight	Approx. 6.2 g (pin plunger model)

Note: 1. The dielectric strength values shown in the table are for models with a Separator.

2. For the pin plunger models, the above values apply for use at both the free position and total travel position. For the lever models, they apply at the total travel position.

3. For testing conditions, contact your OMRON sales representative.

■ Approved Standards

UL1054 (File No. E41515) CSA C22.2 No.55 (File No. LR21642) (Projected) (Only Standard Ratings are listed.)

Rated voltage	D3V-11	D3V-11G	D3V-6	D3V-6G	D3V-01
125 VAC	11 A, 1/2 HP	11 A, 1/2 HP	6 A, 1/4 HP	6 A, 1/4 HP	0.1 A
250 VAC	11 A, 1/2 HP	11 A, 1/2 HP	6 A, 1/4 HP	6 A, 1/4 HP	–
30 VDC	–	–	1 A	1 A	0.1 A
125 VDC	0.6 A	0.1 A	–	–	–
250 VDC	0.3 A	–	–	–	–

EN 61058-1: 1992+A1: 1993 (Projected)

Rated voltage	D3V-11	D3V-6	D3V-01
125 VAC	–	–	0.1 A
250 VAC	11 (3) A	6 (2) A	–

Testing conditions: 50,000 operations, T200 (0°C to 200°C) for D3V-6/D3V-01, T155 (0°C to 155°C) for D3V-11

■ Contact Specifications

Item		D3V-11	D3V-6	D3V-01
Contact	Specification	Rivet		Crossbar
	Material	Silver alloy		Gold alloy
	Gap (standard value)	0.5 mm		1.0 mm
Inrush current	NC	24 A max.	15 A max.	–
	NO			
Minimum applicable load		160 mA at 5 VDC		1 mA at 5 VDC

■ Contact Form

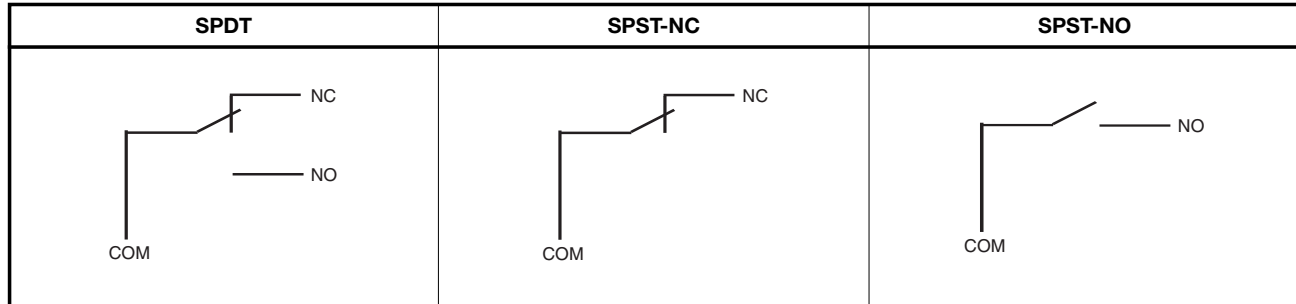

Dimensions

■ Terminals

Note: 1. All units are in millimeters unless otherwise indicated.

2. The table below is for the SPDT contact specifications. Two terminals will be available for SPST-NO or SPST-NC contact specifications. For terminal positions, refer to the above Contact Form.

Terminal type	Solder/Quick-connect Terminal (#187) (A)	Quick-connect Terminal (#187) (C2)	Quick-connect Terminal (#250) (C)
COM			
Terminal dimensions			

■ Mounting Holes

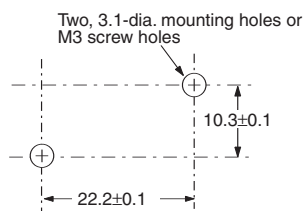

Dimensions & Operating Characteristics

Note: 1. All units are in millimeters unless otherwise indicated.

2. Unless otherwise specified, a tolerance of ± 0.4 mm applies to all dimensions.

3. The following illustrations and drawings are for quick-connect terminals (#187) (terminals C2). D3V models incorporate terminals A and C. These models are different from #187 models in terminal size only. Terminals A and C are omitted from the following drawings. Refer to Terminals on page 10 for these terminals.

4. The following illustrations and drawings are for models with the hinge position set to external/further than plunger. Models with the hinge position set to internal position are not shown here. For details about the internal position models, contact your OMRON sales representative. Operating characteristics are the same for these two types of models.

5. The □ in the model number is for the terminal code.

6. The Δ in the model number is for the mounting hole size.

7. The hole size in the following illustrations of models with a suffix “K” in the Δ is 2.9 mm.

8. The operating characteristics are for operation in the A direction (↓).

Pin Plunger Models

D3V-11-1□5-T-Δ
 D3V-11-1□4-T-Δ
 D3V-11G-1□3-T-Δ
 D3V-6-1□5-T-Δ
 D3V-6-1□4-T-Δ
 D3V-6G-1□3-T-Δ
 D3V-01-1□3-T-Δ

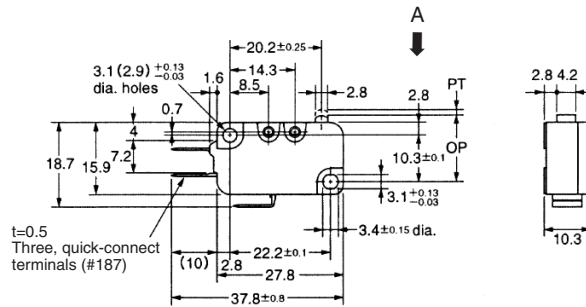

Model	D3V-11-1□5-T-Δ D3V-6-1□5-T-Δ	D3V-11-1□4-T-Δ D3V-6-1□4-T-Δ	D3V-11G-1□3-T-Δ D3V-6G-1□3-T-Δ D3V-01-1□3-T-Δ
OF max. RF min.	1.96 N {200 gf} 0.49 N {50 gf}	0.98 N {100 gf} 0.15 N {15 gf}	0.49 N {50 gf} 0.05 N {5 gf}
PT max. OT max. MD max.	1.2 mm 1.0 mm 0.4 mm (F gap type) or 0.3 (G gap type)		1.2 mm 1.0 mm
OP	14.7 ± 0.4 mm		

Short Hinge Lever Models

D3V-111M-1□5-T-Δ
 D3V-111M-1□4-T-Δ
 D3V-11G1M-1□3-T-Δ
 D3V-61M-1□5-T-Δ
 D3V-61M-1□4-T-Δ
 D3V-6G1M-1□3-T-Δ
 D3V-011M-1□3-T-Δ

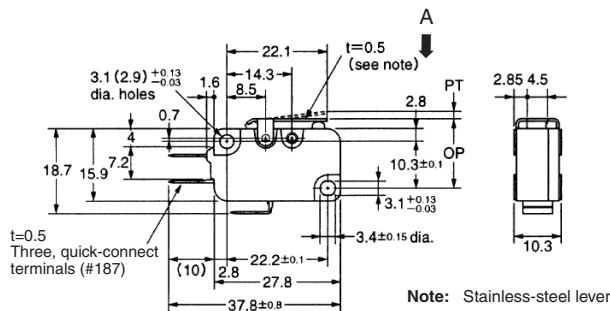

Model	D3V-111M-1□5-T-Δ D3V-61M-1□5-T-Δ	D3V-111M-1□4-T-Δ D3V-61M-1□4-T-Δ	D3V-11G1M-1□3-T-Δ D3V-6G1M-1□3-T-Δ D3V-011M-1□3-T-Δ
OF max. RF min.	1.96 N {200 gf} 0.49 N {50 gf}	0.98 N {100 gf} 0.15 N {15 gf}	0.49 N {50 gf} 0.05 N {5 gf}
PT max. OT max. MD max.	1.6 mm 0.8 mm 0.6 mm		
OP	15.2 ± 0.5 mm		

Hinge Lever Models

- D3V-112M-1□5-T-△
- D3V-112M-1□4-T-△
- D3V-11G2M-1□3-T-△
- D3V-62M-1□5-T-△
- D3V-62M-1□4-T-△
- D3V-6G2M-1□3-T-△
- D3V-012M-1□3-T-△

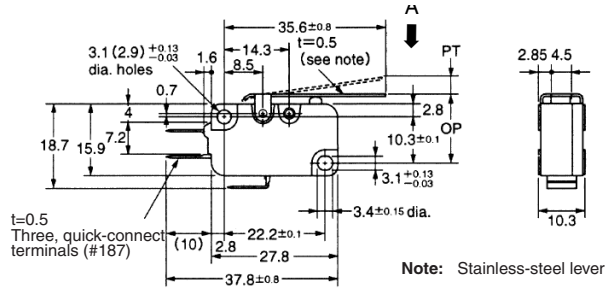

Model	D3V-112M-1□5-T-△ D3V-62M-1□5-T-△	D3V-112M-1□4-T-△ D3V-62M-1□4-T-△	D3V-11G2M-1□3-T-△ D3V-6G2M-1□3-T-△ D3V-012M-1□3-T-△
OF max. RF min.	1.23 N {125 gf} 0.14 N {14 gf}	0.59 N {60 gf} 0.06 N {6 gf}	0.29 N {30 gf}
PT max. OT min. MD max.	4.0mm 1.6 mm 1.5 mm		
OP	15.2 ±1.2mm		

Long Hinge Lever Models

- D3V-113-M-1□5-T-△
- D3V-113-M-1□4-T-△
- D3V-11G3M-1□3-T-△
- D3V-63M-1□5-T-△
- D3V-63M-1□4-T-△
- D3V-6G3M-1□3-T-△
- D3V-013M-1□3-T-△
- D3V-012M-1□3-T-△

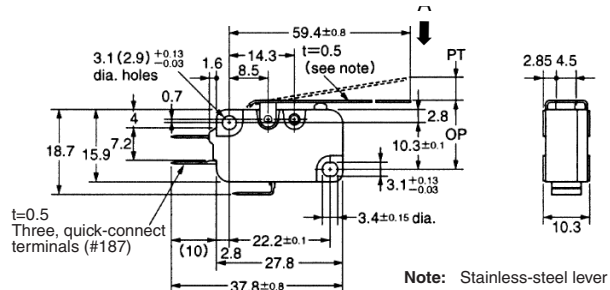

Model	D3V-113M-1□5-T-△ D3V-63M-1□5-T-△	D3V-113M-1□4-T-△ D3V-63M-1□4-T-△	D3V-11G3M-□3-T-△ D3V-6G3M-1□3-T-△ D3V-013M-1□3-T-△
OF max. RF min.	0.69 N {70 gf} 0.06 N {6 gf}	0.34 N {35 gf}	0.20 N {20 gf}
PT max. OT min. MD max.	9.0 mm 2.0 mm 2.8 mm	3.2 mm	
OP	15.2 ±2.6/3.2	15.2 ±2.6	

Simulated Roller Lever Models

- D3V-114M-1□5-T-△
- D3V-114M-1□4-T-△
- D3V-11G4M-1□3-T-△
- D3V-64M-1□5-T-△
- D3V-64M-1□4-T-△
- D3V-6G4M-1□3-T-△
- D3V-014M-1□3-T-△

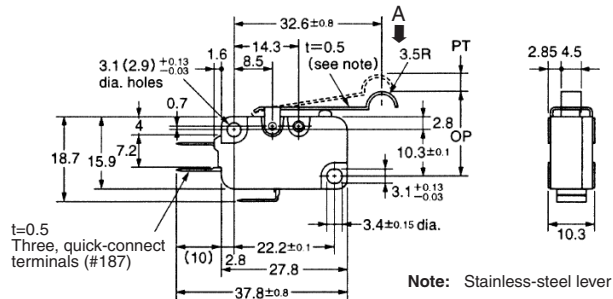

Model	D3V-114M-1□5-T-△ D3V-64M-1□5-T-△	D3V-114M-1□4-T-△ D3V-64M-1□4-T-△	D3V-11G4M-1□3-T-△ D3V-6G4M-1□3-T-△ D3V-014M-1□3-T-△
OF max. RF min.	1.23 N {125 gf} 0.14 N {14 gf}	0.59 N {60 gf} 0.06 N {6 gf}	0.29 N {30 gf}
PT max. OT min. MD max.	4.0 mm 1.6 mm 1.5 mm	– – –	
OP	18.7 ±1.2mm		

High Temperature Miniature Basic Switch – D3V-T

Short Hinge Roller Lever Models

- D3V-115M-1□5-T-△
- D3V-115M-1□4-T-△
- D3V-11G5M-1□3-T-△
- D3V-65M-1□5-T-△
- D3V-65M-1□4-T-△
- D3V-6G5M-1□3-T-△
- D3V-015M-1□3-T-△

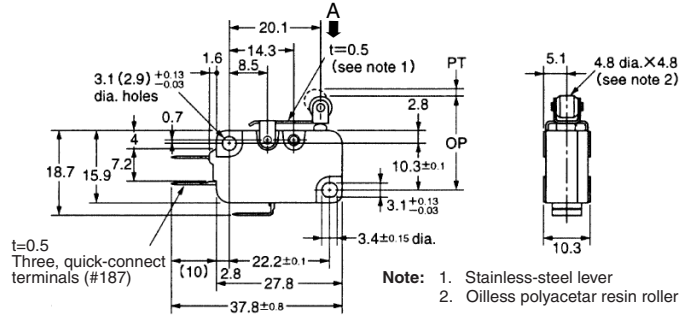
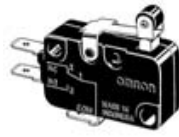

Model	D3V-115M-1□5-T-△ D3V-65M-1□5-T-△	D3V-115M-1□4-T-△ D3V-65M-1□4-T-△	D3V-11G5M-1□3-T-△ D3V-6G5M-1□3-T-△ D3V-015M-1□3-T-△
OF max. RF min.	2.35 N {240 gf} 0.49 N {50 gf}	1.18 N {120 gf} 0.15 N {15 gf}	0.59 N {60gf} 0.06 N {6 gf}
PT max. OT min. MD max.	1.6 mm 0.8 mm 0.6 mm		
OP	20.7 ±0.6mm		

Hinge Roller Lever Models

- D3V-116M-1□5-T-△
- D3V-116M-1□4-T-△
- D3V-11G6M-1□3-T-△
- D3V-66M-1□5-T-△
- D3V-66M-1□4-T-△
- D3V-6G6M-1□3-T-△
- D3V-016M-1□3-T-△

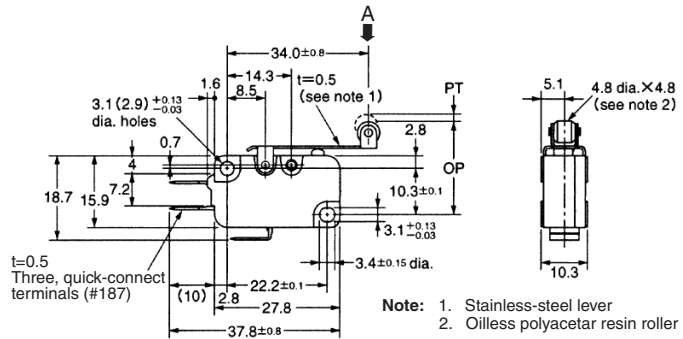

Model	D3V-116M-1□5-T-△ D3V-66M-1□5-T-△	D3V-116M-1□4-T-△ D3V-66M-1□4-T-△	D3V-11G6M-1□3-T-△ D3V-6G6M-1□3-T-△ D3V-016M-1□3-T-△
OF max. RF min.	1.23 N {125 gf} 0.14 N {14 gf}	0.59 N {60 gf} 0.06 N {6 gf}	0.29 N {30 gf}
PT max. OT min. MD max.	4.0mm 1.6 mm 1.5 mm		
OP	20.7 ±1.2 mm		

Precautions

■ Cautions

Handling

Be careful not to drop the switch. Doing so may cause damage to the switch's internal components because it is designed for a small load.

■ Correct Use

Mounting

Use two M3 mounting screws with an appropriate screwdriver to mount the switch. Tighten the screws to a torque of 0.39 to 0.59 N · m {4 to 6 kgf · cm}.

Mounting Direction

Mount lever-operated switches with a maximum operating force of 0.49 N in a direction where the actuator weight will not be applied to the switch. Since the switch is designed for a small load, its resetting force is small. Therefore, resetting failure may occur if unnecessary load is applied to the switch.

Insulation Distance

According to EN61058-1, the minimum insulation thickness for this switch should be 1.1 mm and minimum clearance distance between the terminal and mounting plate should be 1.9 mm. If the insulation distance cannot be provided in the product incorporating the switch, either use a switch with insulation barrier or use a Separator to ensure sufficient insulation distance.

Using Micro Loads

Using a model for ordinary loads to open or close the contact of a micro load circuit may result faulty contact. Use models that operate in the following range. However, even when using micro load models within the operating range shown below, if inrush current occurs when the contact is opened or closed, it may increase contact wear and so decrease life expectancy. Therefore, insert a contact protection circuit where necessary.

The minimum applicable load is the N-level reference value. This value indicates the malfunction reference level for the reliability level of 60% (λ 60). The equation, λ 60 = 0.5×10^{-6} /operations indicates that the estimated malfunction rate is less than 1/2,000,000 operations with a reliability level of 60%.

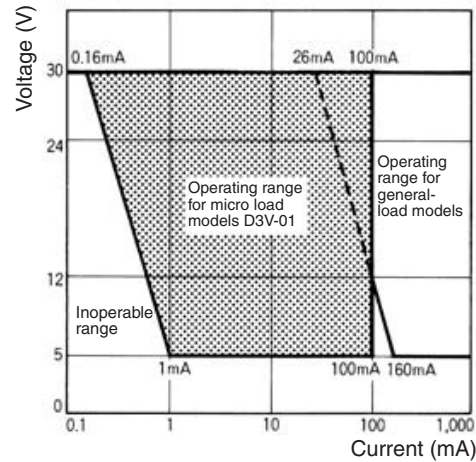

Solder Terminal Approval Conditions

Soldering iron can be used.
Soldering hook hole available.
Soldering terminal types 1 and 2 are met.

ALL DIMENSIONS SHOWN ARE IN MILLIMETERS.

To convert millimeters into inches, multiply by 0.03937. To convert grams into ounces, multiply by 0.03527.