

Low-cost DIP Switch with Slide Pins

- Designed to DIP (Dual Inline Package) standards and allows automatic mounting with IC insertion machines.
- Washable models with seal tape available.
- SMT (surface-mounted terminal) models available with embossed taping specifications (units of 900).
- Gold-plated twin contacts and a slide-type, self-cleaning mechanism ensure high reliability.

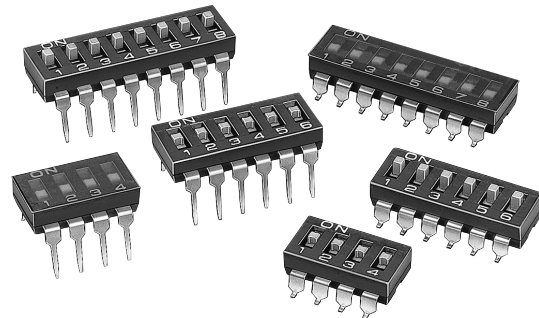

Ordering Information

Type (striker color)	Flat actuator (Yellow)			Raised actuator (Yellow)	Type (striker color)	Flat actuator (Yellow)			Raised actuator (Yellow) (See note 2.)	
	Standard		With seal tape			Standard		With seal tape		
	DIP terminal	DIP terminal	DIP terminal			SMT terminal	SMT terminal	SMT terminal		
	No. of poles	Quantity per stick			No. of poles	Quantity per stick		Per stick	Per embossed tape (units of 900) (See note 1.)	
1	130	A6T-1101	A6T-1102	A6T-1104	1	---	---	---	---	---
2	76	A6T-2101	A6T-2102	A6T-2104	2	76	A6S-2101	A6S-2102	---	A6S-2104
3	55	A6T-3101	A6T-3102	A6T-3104	3	55	A6S-3101	A6S-3102	---	A6S-3104
4	42	A6T-4101	A6T-4102	A6T-4104	4	42	A6S-4101	A6S-4102	A6S-4102-P	A6S-4104
5	35	A6T-5101	A6T-5102	A6T-5104	5	35	A6S-5101	A6S-5102	---	A6S-5105
6	28	A6T-6101	A6T-6102	A6T-6104	6	28	A6S-6101	A6S-6102	A6S-6102-P	A6S-6104
7	25	A6T-7101	A6T-7102	A6T-7104	7	25	A6S-7101	A6S-7102	---	A6S-7104
8	22	A6T-8101	A6T-8102	A6T-8104	8	22	A6S-8101	A6S-8102	A6S-8102-P	A6S-8104
9	20	A6T-9101	A6T-9102	A6T-9104	9	20	A6S-9101	A6S-9102	---	A6S-9104
10	18	A6T-0101	A6T-0102	A6T-0104	10	18	A6S-0101	A6S-0102	A6S-0102-P	A6S-0104

- Note:**
1. Switches are packaged in units of 900. Orders must be made in multiples of 900. Switches are not sold individually.
 2. Raised actuators on embossed tape must be requested separately because orders can vary by such factors as units per order.

Specifications

■ Ratings/Characteristics

Switching capacity	25 mA at 24 VDC 10 μ A (minimum current) at 3.5 VDC
Ambient temperature	Operating: -20°C to 70°C (with no icing)
Ambient humidity	Operating: 35% to 90%
Insulation resistance	100 M Ω min. (at 250 VDC)
Contact resistance	200 m Ω max. (initial value)
Dielectric strength	500 VAC for 1 min between terminals of the same polarity, and between terminals of different polarity
Vibration resistance	Malfunction: 10 to 55 Hz, 1.5-mm double amplitude
Shock resistance	Malfunction: 300 m/s ² min.
Life expectancy	Mechanical: 1,000 operations min. Electrical: 1,000 operations min.
Operating force	Flat/raised type 0.29 N min. {30 gf}
Weight	A6T: 0.26 g (2 poles), 0.44 g (4 poles), 0.62 g (6 poles), 0.79 g (8 poles), 0.96 g (10 poles) A6S: 0.25 g (2 poles), 0.41 g (4 poles), 0.58 g (6 poles), 0.73 g (8 poles), 0.87 g (10 poles)

Dimensions

Note: 1. All units are in millimeters unless otherwise indicated.

2. Unless otherwise specified, a tolerance of ± 0.4 mm applies to all dimensions.

Flat Actuator with DIP Terminal Standard/With Seal Tape

A6T-□101
A6T-□102

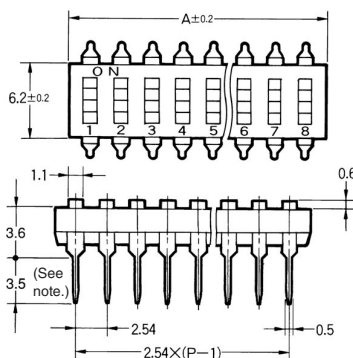
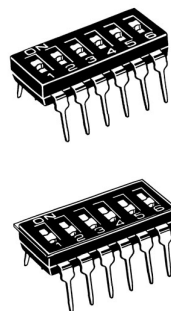

Note: Terminal length decreased from 4.3 mm to 3.5 mm as of May 2003.

Flat Actuator Standard

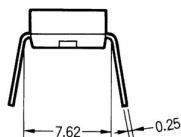

With Seal Tape

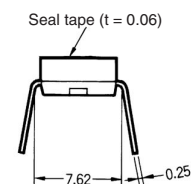

Raised Actuator

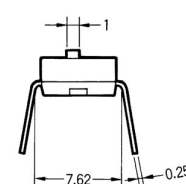

Raised Actuator with DIP Terminal A6T-□104

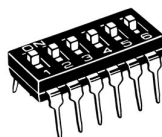

PCB Dimensions (Top View)

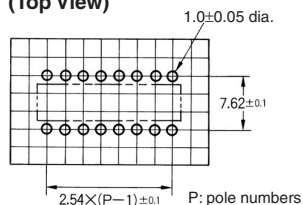

No. of poles	Model			Dimension A
	A6T-1101	A6T-1102	A6T-1104	
1	A6T-1101	A6T-1102	A6T-1104	3.48
2	A6T-2101	A6T-2102	A6T-2104	6.02
3	A6T-3101	A6T-3102	A6T-3104	8.56
4	A6T-4101	A6T-4102	A6T-4104	11.10
5	A6T-5101	A6T-5102	A6T-5104	13.64
6	A6T-6101	A6T-6102	A6T-6104	16.18
7	A6T-7101	A6T-7102	A6T-7104	18.72
8	A6T-8101	A6T-8102	A6T-8104	21.26
9	A6T-9101	A6T-9102	A6T-9104	23.80
10	A6T-0101	A6T-0102	A6T-0104	26.34

**Flat Actuator with SMT Terminal
Standard/With Seal Tape**

A6S-□101
A6S-□102

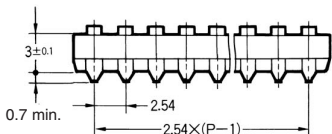
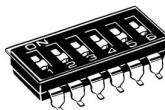
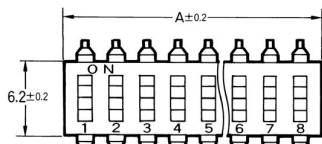
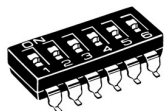

**Flat Actuator
Standard**

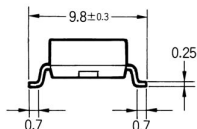

With Seal Tape

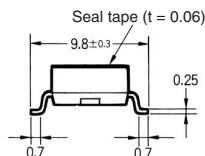

Raised Actuator

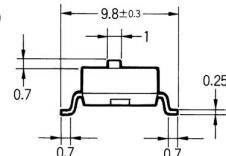

**Raised Actuator
with SMT Terminal**

A6S-□104

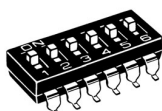

**PCB Dimensions
(Top View)**

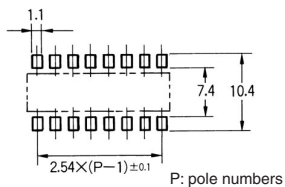

No. of poles	Model			Dimension A
	A6S-2101	A6S-2102	A6S-2104	
2	A6S-2101	A6S-2102	A6S-2104	6.02
3	A6S-3101	A6S-3102	A6S-3104	8.56
4	A6S-4101	A6S-4102	A6S-4104	11.10
5	A6S-5101	A6S-5102	A6S-5104	13.64
6	A6S-6101	A6S-6102	A6S-6104	16.18
7	A6S-7101	A6S-7102	A6S-7104	18.72
8	A6S-8101	A6S-8102	A6S-8104	21.26
9	A6S-9101	A6S-9102	A6S-9104	23.80
10	A6S-0101	A6S-0102	A6S-0104	26.34

Installation

■ **Internal Connections (Top View)**



Precautions

Be sure to refer to General Precautions on pages 4 to 6 for details on proper use.

ALL DIMENSIONS SHOWN ARE IN MILLIMETERS.
To convert millimeters into inches, multiply by 0.03937. To convert grams into ounces, multiply by 0.03527.

Safety Precautions

■ Cautions

Use the DIP Switch within the rated voltage and current ranges, otherwise the DIP Switch may have a shortened life expectancy, radiate heat, or burn out. This particularly applies to the instantaneous voltages and currents when switching.

■ Correct Use

Circuit Design

Although the minimum current is 10 μ A (3.5 VDC), contact reliability may need to be improved in some cases. This is particularly true when switching causes an increase in instantaneous current, such as in C-MOS IC applications. Do not let the peak current exceed the rated value here or any other time.

Only BCD/hexadecimal 1-2-4-8 code is available for A6C/A6CV/A6R/A6RV models. If BCD/hexadecimal 1-2-4-8 complement code is required, make the appropriate provisions in the circuit.

Mounting

Normally the default striker setting is OFF for slide-type DIP Switches and the default rotor setting is 0 for Rotary DIP Switches. Do not change these settings when mounting, soldering, washing or drying Switches. In rare cases, the striker may be deformed by heat generated during soldering.

1. Automatic Insertion Machine

Use a body stopper system for the chute stopper of automatic insertion machines. When mounting Switches using an insertion machine incorporating a half-lead stopper, make sure the machine will not deform the terminals of the Switch, or improper insertion may result. Check actual mounting conditions prior to using a half-lead stopper system.

A printed circuit board that is 1.2 to 1.6 mm thick is recommended.

Holes on the PCB should be at least 0.9 mm in diameter for automatic insertion.

2. Manual or IC Socket Insertion

Commercially available insertion tools are recommended for mounting ICs on PCBs.

Terminal pitch, dimensions and other features are identical to that of standard ICs for IC socket compatibility (except for the A6S-H and A6H).

Align the terminals so they slide in simultaneously when the Switch is inserted into socket holes or into mounting holes pre-drilled at the specified dimensions. Apply downward force on the Switch until the terminals are properly seated on the PCB.

Do not try to remove a Switch by inserting a screwdriver between it and the PCB, and then twisting the screwdriver to peel the Switch off. Use a commercially available inserter/remover to remove the Switch.

Soldering

Observe the following conditions when soldering the DIP Switch.

1. General Precautions for Soldering

Make sure that the striker of slide-type DIP Switches is set fully to either ON or OFF. (For A6E and A6ER models, however, set the Switch to OFF before soldering.) Make sure that Rotary DIP Switches are correctly set to 0. Misalignment may result in reduced sensitivity due to the soldering heat.

Before soldering the Switch on a PCB, make sure there is no unnecessary space between the Switch and the PCB.

Before soldering the Switch on a multilayer PCB, conduct a test to make sure the Switch will not be deformed by soldering heat on the pattern or land of the multilayer PCB.

2. Automatic Soldering Bath (Except A6S-H/A6H)

Soldering temperature: 260°C max.

Soldering time: 5 s max. for a 1.6-mm thick, single-side PCB

Do not use an automatic soldering bath or manual soldering for A6S-H or A6H models.

Confirm in advance that flux will not bubble up onto the side of the PCB to which the Switch is mounted. Depending on the type of Switch, the flux may have an adverse effect if it enters the Switch.

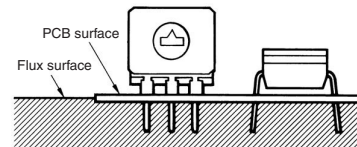

The A6S-H and A6H are designed specifically for reflow soldering. Do not use an automatic soldering bath or manual soldering for these models.

3. Reflow Soldering

Observe the following conditions for reflow soldering the A6S-H and A6H models. (Measurement location: Top of Switch)

A6S-H Soldering Conditions

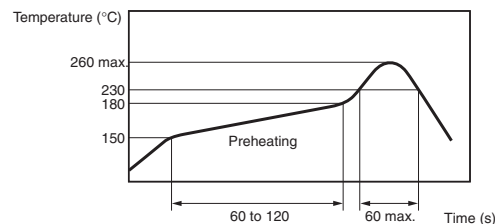

A6H Soldering Conditions

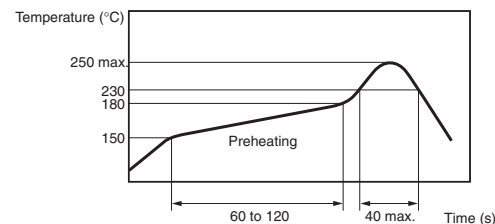

Do not use reflow soldering for any models other than the A6S-H and A6H. Otherwise the plastic case may melt or deform.

The soldering conditions and the temperature around the Switch may vary with the type of reflow bath. Check the temperature profile and confirm soldering conditions as well as the amount of heat applied to the Switch prior to soldering.

4. Manual Soldering (Except A6S-H/A6H)

Soldering temperature: 350°C at the tip of the soldering iron.

Soldering time: 3 s max. for a 1.6-mm thick, single-side PCB

Do not solder the Switch more than twice including any rectification soldering. An interval of five minutes is required between the first and second soldering.

5. Using Flux

Making mistakes in the type of flux or in the amount or method in which it is applied can cause flux to enter the interior of the Switch, with adverse effects on Switch performance. Assess the proper flux, conditions, and methods prior to using it.

Washing

1. Washable and Non-washable Models

The models for which washing are possible are shown in the following table.

Washable	A6A, A6C, A6CV, A6D, A6DR, A6T (with seal tape), A6S-H (with seal tape), A6H (with seal tape)
Non-washable	A6R, A6RV, A6T (standard/raised actuator), A6S-H (standard/raised actuator), A6E, A6ER

2. Washing Procedure

Ultrasonic cleaning is not available for slide-type DIP Switches with seal tape. These models may be wiped or dipped into washing agents for one minute maximum.

Slide-type DIP Switches with seal tape can be washed as long as the seal tape is not removed or pasted before washing. Non-compliance here will cause the quality of the seal to decline.

Washing equipment incorporating more than one washing bath can be used to clean washable models, provided that the washable models are cleaned for one minute maximum per bath and the total cleaning time does not exceed three minutes.

Handling

1. Slide-type DIP Switch operation

Do not apply excessive operating force to the Switch. Otherwise the Switch may be damaged or deformed, and the switch mechanism may malfunction as a result. Apply an operating force not exceeding 9.8 N. (Operate each pole separately.) Apply the operating load from the side of the striker. Do not apply a load from an angle or from above the striker. Doing so may deform the Switch contact.

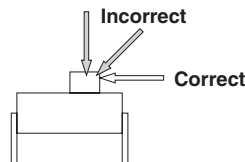

Set slide-type DIP Switches with a tiny, rounded object, such as the tip of a ball-point pen or a small screwdriver. Do not set the DIP Switch using tweezers or any other sharp object that may damage it. Do not set the DIP Switch using the point of a mechanical pencil, or lead powder or fragments may fall into the Switch and internal circuit board, causing the DIP Switch to malfunction and reducing the dielectric strength of the circuit board.

3. Washing Agents

Apply alcohol-based solvents to clean washable models. Do not apply water or any other agents to clean any washable models, as such agents may degrade the materials or performance of the Switch.

4. Washing Precautions

Do not impose any external force on washable models while washing.

Do not clean washable models immediately after soldering. The cleaning agent may be absorbed into the incomplete seal through respiration as the Switch cools. Wait for at least three minutes after soldering before cleaning.

Do not use washable Switches submerged in water or in locations exposed to water.

Although raised-type and piano-type strikers can be operated by fingertip, do not push too hard or too fast because this will deform or damage the striker.

When setting or operating the A6H, use narrow-headed tweezers or similar implement (without a sharp end), to enable smooth, horizontal operation. Pushing the striker at an angle, or applying excessive load from above may damage or deform the striker and thereby prevent operation.

2. Rotary DIP Switch Operation

Set rotary-type DIP Switches with a flat-blade screwdriver that fits into the screwdriver groove. Using a screwdriver of inappropriate dimensions, or using a tool other than a flat-blade screwdriver may cause damage to the groove that may make the Switch impossible to operate.

Insert the flat-blade screwdriver vertically to operate the Switch. The Switch may be damaged if the screwdriver is inserted at an angle.

Do not use excessive force to operate the Switch, or it may damage or deform the Switch.

3. Setting

Set the Switch to the correct position before use. An incorrectly aligned position may result in incorrect signals.

Rotary DIP Switch Operation

Item	A6R/A6RV	A6A		A6C/A6CV
	Top/Side operation, flat type	Standard type, flat type	Shaft type, wheel type	Top/Side operation type
Screwdriver groove	Depth: 1.0	Depth: 0.9	Depth: 0.9	Depth: 1.0
Applicable screwdriver: A	1.8 to 2.1	3.5 to 3.8		2.0 to 2.4
Applicable screwdriver: B	0.7 to 0.8	0.4 to 0.5		0.5 to 0.6
Part names	<p>A — Flat-blade screwdriver B — Groove A6A, A6C/A6CV, A6R/A6RV Rotary DIP Switch</p>			

Note: All units are in millimeters unless otherwise indicated.

■ Packing specifications

• A6S-H models with embossed taping specifications are shown below.

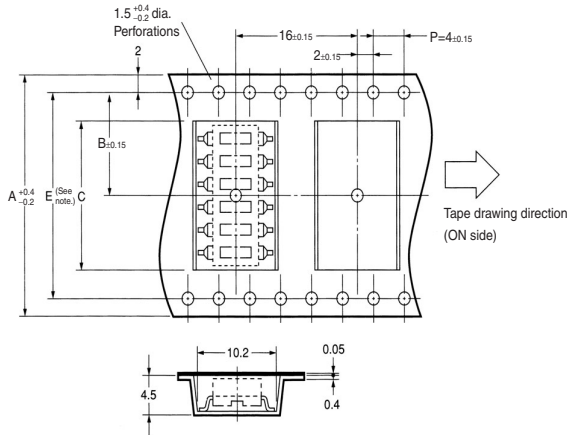

Note: The perforations along both sides are for Switches with 7 poles or more. The perforations on the bottom of the diagram are not provided on Switches with 6 poles or less.

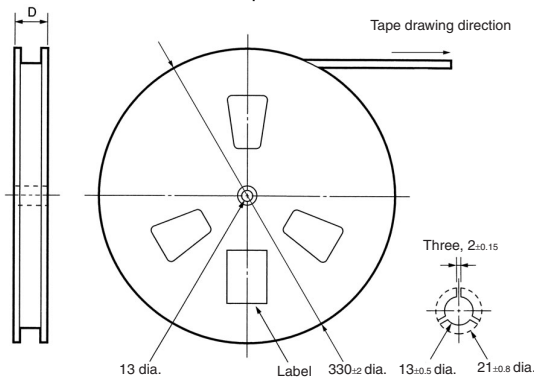

Applicable models	A6S-□102-PH
Standard	Conforms to JEITA.
Package quantity	900 per reel

Applicable models	A6S-□10□-PMH
Standard	Conforms to JEITA.
Package quantity	400 per reel

Note: The dimensions and quantity of A6S-□104-PH/PMH and 1-pole models are different. Enquire for details separately.

No. of poles	2	3	4	5	6	7	8	9	10
A ^{+0.4} / _{-0.2}	16	24	24	24	24	32	32	44	44
B±0.15	7.5	11.5	11.5	11.5	11.5	14.2	14.2	20.2	20.2
C	6.6	9.1	11.6	14.2	16.7	19.2	21.7	24.3	26.8
D	(22)	(30)	(30)	(30)	(30)	(38)	(38)	(50)	(50)
E	---	---	---	---	---	28.4	28.4	40.4	40.4

• A6H models with embossed taping specifications are shown below.

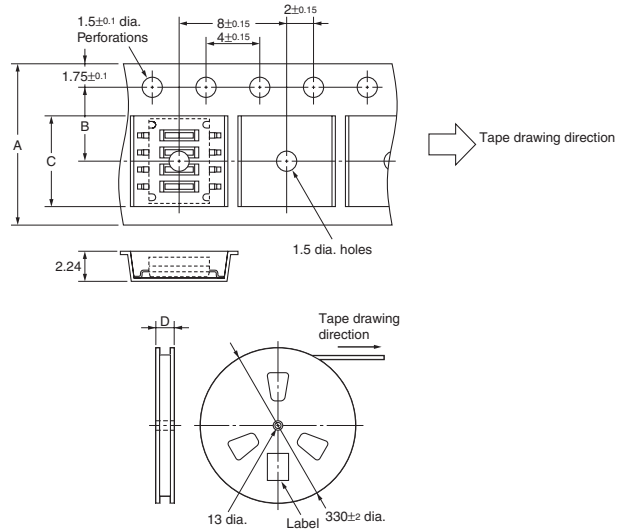

Applicable models	A6H-□102-P
Standard	Conforms to JEITA.
Package quantity	4,000 per reel

Applicable models	A6H-□10□-PM
Standard	Conforms to JEITA.
Package quantity	500 per reel

No. of poles	2	4	6	8	10
A ^{+0.3} / _{-0.1}	12	12	24	24	24
B±0.13	5.5	5.5	11.5	11.5	11.5
C	(4.2)	(6.6)	(9.2)	(11.7)	(14.4)
D	(18)	(18)	(30)	(30)	(30)