

Snap-action Switch with Ultra Subminiature Size (6.5 × 8.2 × 2.7 mm (H × W × D)) and Light Weight (0.3 g)

- Excellent electrical characteristics and a snap-action mechanism in spite of its ultra small size.
- Gold-plated (Au-P) contacts for micro load switching available in addition to silver-plated contacts (Ag-P).
- Ideal for applications where size is extremely limited and high reliability is demanded, such as in compact audio, optical, and telecommunications equipment.

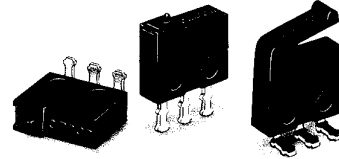

Ordering Information

Model Number Legend

D2MQ-1

1 2 3 4

1. Ratings

- 1: Silver-plated contact type (0.5 A at 30 VDC)
- Gold-plated contact type (50 mA at 30 VDC)

2. Actuator

- None: Pin plunger
- L: Leaf lever

3. Contact Material

- None: Silver-plated
- 105: Gold-plated

4. Terminals

- None: Straight terminals
- TL: Left-angled terminals
- TR: Right-angled terminals

D2MQ-4L **-1-**

1 2 3

1. Actuator

- 4L: Hinge leaf lever









2. Contact Material (Rating)

- None: Silver-plated (0.5 A at 30 VDC)
- 105: Gold-plated (50 mA at 30 VDC)

3. Terminals

- None: Straight terminals
- L: Left-angled terminals
- R: Right-angled terminals

List of Models

Actuator Terminals	Standard model (Ag-plated)			Micro load model (Au-plated)		
	Straight terminals 	Left-angled terminals 	Right-angled terminals 	Straight terminals 	Left-angled terminals 	Right-angled terminals 
Pin plunger 	D2MQ-1	D2MQ-1-TL	D2MQ-1-TR	D2MQ-1-105	---	---
Leaf lever 	D2MQ-1L	D2MQ-1L-TL	D2MQ-1L-TR	D2MQ-1L-105	---	---
Hinge leaf lever 	D2MQ-4L-1	D2MQ-4L-1-L	D2MQ-4L-1-R	D2MQ-4L-105-1	D2MQ-4L-105-1-L	D2MQ-4L-105-1-R

Note: The terminal shape drawings indicate the shape when the Switch is viewed from the direction of the arrow in the drawing below.

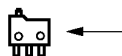

Specifications

■ Ratings

Rated voltage	Type Item	Silver-plated contact type	Gold-plated contact type
		Resistive load	
30 VDC		0.5 A	50 mA

Note: The ratings values apply under the following test conditions:

Ambient temperature: 20±2°C

Ambient humidity: 65±5%

Operating frequency: 30 operations/min

■ Characteristics

Operating speed (see note 2)	0.1 mm to 0.5 m/s
Operating frequency	Mechanical: 60 operations/min max. Electrical: 30 operations/min max.
Insulation resistance	100 MΩ min. (at 250 VDC)
Contact resistance (initial value)	100 mΩ max.
Dielectric strength	500 VAC, 50/60 Hz for 1 min between terminals at the same polarity 500 VAC, 50/60 Hz for 1 min between current-carrying metal parts and ground
Vibration resistance (see note 3)	Malfunction: 10 to 55 Hz, 1.5-mm double amplitude (see note 2)
Shock resistance (see note 3)	Destruction: 1,000 m/s ² {approx. 100G} max. Malfunction: 300 m/s ² {approx. 30G} max.
Durability (see note 4)	Mechanical: 30,000 operations min. (60 operations/min) Electrical: 10,000 operations min. (30 operations/min)
Degree of protection	IEC IP40
Degree of protection against electric shock	Class I
Proof tracking index (PTI)	175
Ambient operating temperature	-15°C to 70°C (at ambient humidity of 60% max.) (with no icing)
Ambient operating humidity	35% to 85% (for 5°C to 35°C)
Weight	Approx. 0.3 g

- Note:**
1. The data given above are initial values.
 2. The values are for the pin plunger models. (For different models, consult your OMRON representative.)
 3. Malfunction: 1 ms max.
 4. For testing conditions, consult your OMRON sales representative.

■ Contact Specifications

Item		Silver-plated contact type	Gold-plated contact type
Contact	Specification	Rivet	
	Material	Silver plated	Gold plated
	Gap (standard value)	0.15 mm	
Inrush current	NC	0.5 A max.	0.05 A max.
	NO	0.5 A max.	0.05 A max.
Minimum applicable load		50 mA at 5 VDC	5 mA at 5 VDC

■ Contact Form

SPDT

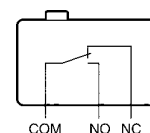

Engineering Data (Reference Values)

Mechanical Durability (D2MQ-1)

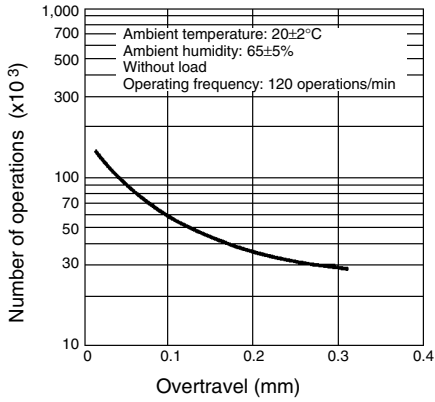

Electrical Durability (D2MQ-1)

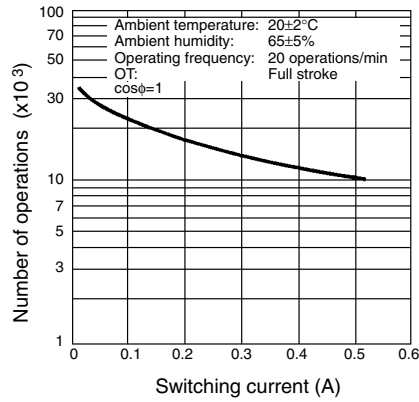

Dimensions

Note: All units are in millimeters unless otherwise indicated.

Terminals

Straight Terminals

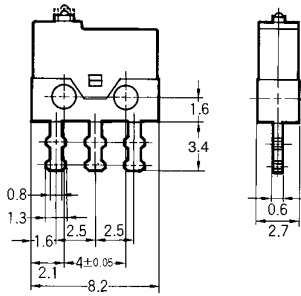

Left-angled Terminals

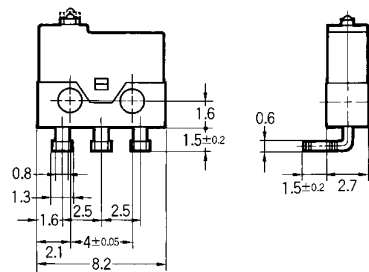

Right-angled Terminals

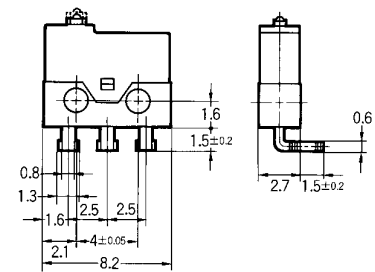

Mounting Dimensions

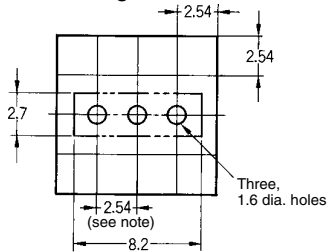

Note: Terminal gap: 1 pitch

Mounting Holes

Two, 1.6-dia. mounting holes or M1.4 screw holes

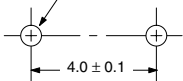

■ Dimensions and Operating Characteristics

- Note:**
1. All units are in millimeters unless otherwise indicated.
 2. Unless otherwise specified, a tolerance of 0.15 mm applies to all dimensions.
 3. The following illustrations are for the straight terminal models. Those for the left-angled terminals and right-angled terminals are different from straight terminal models in terminal size only. Refer to *Terminals* on page 211 for these terminals.
 4. The operating characteristics are for operation in the A direction (▼).

Pin Plunger Models

- D2MQ-1 (Straight Terminals)
- D2MQ-1-TL (Left-angled terminals)
- D2MQ-1-TR (Right-angled terminals)
- D2MQ-1-105 (Straight Terminals)

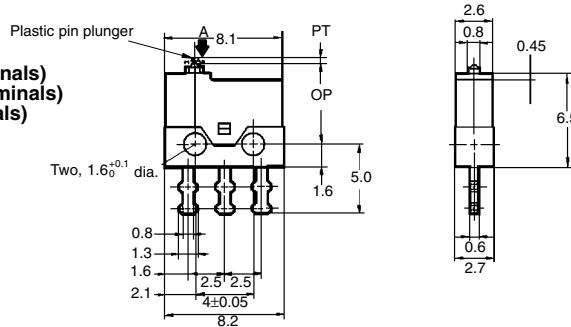
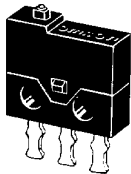

OF max.	1.18 N {120 gf}
RF min.	0.19 N {20 gf}
PT max.	0.4 mm
OT min.	0.1 mm
MD max.	0.1 mm
OP	5.7±0.2 mm

Leaf Lever Models

- D2MQ-1L (Straight Terminals)
- D2MQ-1L-TL (Left-angled terminals)
- D2MQ-1L-TR (Right-angled terminals)
- D2MQ-1L-105 (Straight Terminals)

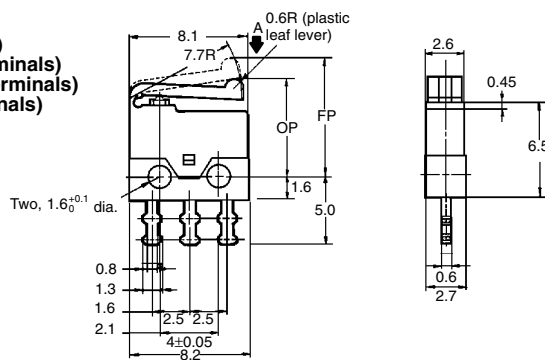
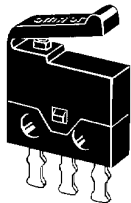

OF max.	0.59 N {60 gf}
RF min.	0.08 N {8 gf}
PT max.	2.4 mm
OT min.	0.3 mm
MD max.	0.7 mm
FP max.	9.6 mm
OP	6.7±0.5 mm

Hinge Leaf Lever Models

- D2MQ-4L-1
- D2MQ-4L-1-L
- D2MQ-4L-1-R
- D2MQ-4L-105-1
- D2MQ-4L-105-1-L
- D2MQ-4L-105-1-R

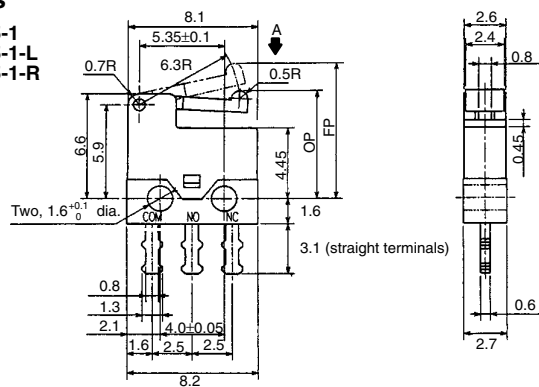
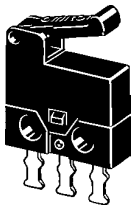

OF max.	0.39 N {40 gf}
RF min.	0.04 N {4 gf}
PT max.	2.1 mm
OT min.	0.3 mm
MD max.	0.7 mm
FP max.	8.7 mm
OP	7.1±0.5 mm

Precautions

Refer to pages 26 to 31 for common precautions.

■ Cautions

Terminal Connections

Make sure that the capacity of the soldering iron is 15 W maximum (temperature of soldering iron: 250°C max.). Do not take more than 3 s to solder the switch terminal.

If soldering is not carried out under the proper conditions there is a danger of over-heating and subsequent heat damage.

Applying a soldering iron for more than 3 s or using one that is rated at more than 15 W may deteriorate the Switch characteristics.

When soldering the lead wire to the PCB terminal, pay careful attention so that the flux and solder liquid level does not exceed the PCB level.

■ Correct Use

Mounting

Use M1.4 mounting screws with screws to securely mount the Switch. Tighten the screws to a torque of 0.1 N • m {1 kgf • cm}.

Operation

Do not apply a force more than two times the rated operating force to the actuator and leaf lever.

Provide an amount of OT that equals or exceeds the standard.

Do not change the operating position by modifying the actuator.

Do not use the Switch in an application where the operating speed is extremely slow or the actuator is set in the midpoint between the free position and operating position.

Install the pin plunger switch so that the operating force is applied in alignment with the stroke of the actuator.

Do not apply a shock to the actuator, otherwise, the Switch may be damaged.

Do not apply excessive force to the actuator of the Leaf Lever Switch in the operating, releasing, and horizontal directions.

Separator

When mounting the Switch on a metallic surface, be sure to provide a Separator between the Switch and mounting plate.

The Separator must be made of hard material and must be processed as shown below.

Dimensions of Separator

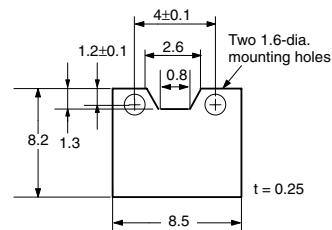

ALL DIMENSIONS SHOWN ARE IN MILLIMETERS.

To convert millimeters into inches, multiply by 0.03937. To convert grams into ounces, multiply by 0.03527.