

Miniature Rotary DIP Switch

A6K/A6KS

Miniature (7.2 × 7.2mm size) Rotary DIP Switch

- Mounting space reduced by 50%.
(compared with conventional models)
- SMT and through hole type Available.
Side-actuated type available.
- Gold-plated contacts ensure high reliability.

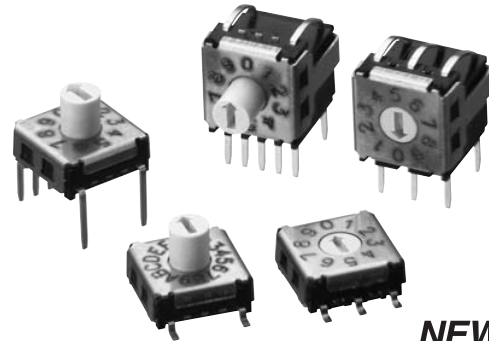

NEW

RoHS Compliant (Refer to page 6 for details)

Ordering Information

■Through hole type (3 × 3 Terminal)

| Type (rotor color) | | | Top-actuated, flat (White) | Top-actuated, extended shaft (White) | Side-actuated, flat (White) | Side-actuated, extended shaft (White) |
|----------------------------|--------------------|-------------|----------------------------|--------------------------------------|-------------------------------------|---------------------------------------|
| No. of switching positions | Quantity per stick | Output code | | | | |
| | | | 10 | Top :63 Side:60 | BCD/ hexadecimal 1-2-4-8 code | A6K-102RF |
| 16 | | | A6K-162RF | A6K-162RS | A6KV-162RF | A6KV-162RS |

■Through hole type (5 × 2 Terminal)

| Type (rotor color) | | | Top-actuated, flat (White) | Top-actuated, extended shaft (White) | Side-actuated, flat (White) | Side-actuated, extended shaft (White) |
|----------------------------|--------------------|-------------|----------------------------|--------------------------------------|-------------------------------------|---------------------------------------|
| No. of switching positions | Quantity per stick | Output code | | | | |
| | | | 10 | Top :63 Side:60 | BCD/ hexadecimal 1-2-4-8 code | A6K-104RF |
| 16 | | | A6K-164RF | A6K-164RS | A6KV-164RF | A6KV-164RS |



■SMT type (3 × 3 Terminal, Stick)

| Type (rotor color) | | | Top-actuated, flat (White) | Top-actuated, extended shaft (White) |
|----------------------------|--------------------|-------------|----------------------------|--------------------------------------|
| No. of switching positions | Quantity per stick | Output code | | |
| | | | 10 | 63 |
| 16 | | | A6KS-162RF | A6KS-162RS |



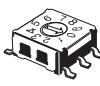

■SMT type (5 × 2 Terminal, Stick)

| Type (rotor color) | | | Top-actuated, flat (White) | Top-actuated, extended shaft (White) | Side-actuated, flat (White) | Side-actuated, extended shaft (White) |
|----------------------------|--------------------|-------------|----------------------------|--------------------------------------|-------------------------------------|---------------------------------------|
| No. of switching positions | Quantity per stick | Output code | | | | |
| | | | 10 | 63 | BCD/ hexadecimal 1-2-4-8 code | A6KS-104RF |
| 16 | | | A6KS-164RF | A6KS-164RS | A6KSV-164RF | A6KSV-164RS |

■SMT type (3 × 3 Terminal, Embossed tape)

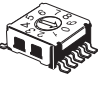
| Type (rotor color) | | Top-actuated, flat (White) | | Top-actuated, extended shaft (White) | |
|----------------------------|-------------|----------------------------|---|--------------------------------------|---|
| No. of switching positions | Output code | Quantity per embossed tape |  | Quantity per embossed tape |  |
| | | 10 | BCD/hexadecimal 1-2-4-8 code | 1450 | A6KS-102RF-P |
| 16 | | A6KS-162RF-P | A6KS-162RS-P | | |

■SMT type (5 × 2 Terminal, Embossed tape)

| Type (rotor color) | | Top-actuated, flat (White) | | Top-actuated, extended shaft (White) | | Side-actuated, flat (White) | | Side-actuated, extended shaft (White) | |
|----------------------------|-------------|----------------------------|---|--------------------------------------|---|-----------------------------|---|---------------------------------------|---|
| No. of switching positions | Output code | Quantity per embossed tape |  | Quantity per embossed tape |  | Quantity per embossed tape |  | Quantity per embossed tape |  |
| | | 10 | BCD/hexadecimal 1-2-4-8 code | 1450 | A6KS-104RF-P | 850 | A6KS-104RS-P | 1450 | A6KSV-104RF-P |
| 16 | | A6KS-164RF-P | A6KS-164RS-P | | A6KSV-164RF-P | | A6KSV-164RS-P | | |

Note: Orders must be made in multiples of pack quantity. Switch are not sold individually.

Specifications

| | | |
|-------------------------------|--|---|
| Rating | 24 VDC 25 mA, 3.5 VDC 10 μ A (minimum current) | |
| Ambient operating temperature | - 30 °C to 80 °C 60 %RH max. (with no icing or dewing) | |
| Ambient operating humidity | 35 to 95 %RH (for 5 to 35 °C) | |
| Insulation resistance | 100 M Ω min. | |
| Contact resistance | 200 m Ω max. (initial value) | |
| Dielectric strength | 250 VAC for 1 minute between terminals of the same polarity, and between terminals of different polarity | |
| Vibration resistance | Malfunction: 10 to 55 Hz, 1.5-mm double amplitude | |
| Shock resistance | Malfunction: 300 m/s ² min. | |
| Electrical life expectancy | 20,000 steps (24 VDC 25 mA) | |
| Operating torque | 1.96 × 10 ⁻² N•m max. | |
| Weight | Through hole terminal | Top-actuated, flat: 0.38 g, Side-actuated, flat: 0.71 g |
| | SMT terminal | Top-actuated, flat: 0.36 g, Side-actuated, flat: 0.39 g |

*Add 0.03 g for the extended-shaft version of each model

Output Codes

10-position Models

| Position | Code | BCD/hexadecimal 1-2-4-8 code | | | |
|----------|------|------------------------------|---|---|---|
| | | 1 | 2 | 4 | 8 |
| 0 | | | | | |
| 1 | ● | | | | |
| 2 | | ● | | | |
| 3 | ● | ● | | | |
| 4 | | | ● | | |
| 5 | ● | | ● | | |
| 6 | | ● | ● | | |
| 7 | ● | ● | ● | | |
| 8 | | | | | ● |
| 9 | ● | | | | ● |

Note: "●" indicates that the internal switch is ON.

16-position Models

| Position | Code | BCD/hexadecimal 1-2-4-8 code | | | |
|----------|------|------------------------------|---|---|---|
| | | 1 | 2 | 4 | 8 |
| 0 | | | | | |
| 1 | ● | | | | |
| 2 | | ● | | | |
| 3 | ● | ● | | | |
| 4 | | | ● | | |
| 5 | ● | | ● | | |
| 6 | | ● | ● | | |
| 7 | ● | ● | ● | | |
| 8 | | | | | ● |
| 9 | ● | | | | ● |
| A | | ● | | | ● |
| B | ● | ● | | | ● |
| C | | | ● | | ● |
| D | ● | | ● | | ● |
| E | | ● | ● | | ● |
| F | ● | ● | ● | | ● |

Dimensions

(unit: mm)

Through hole type

● Top-actuated Flat Models with 3×3 Terminal Arrangement A6K-102RF A6K-162RF

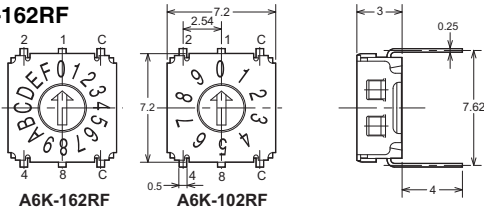

● Top-actuated Extended shaft Models with 3×3 Terminal Arrangement A6K-102RS A6K-162RS

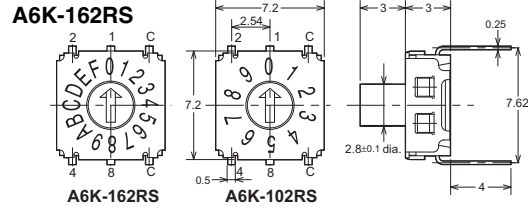

● Side-actuated Flat Models with 3×3 Terminal Arrangement A6KV-102RF A6KV-162RF

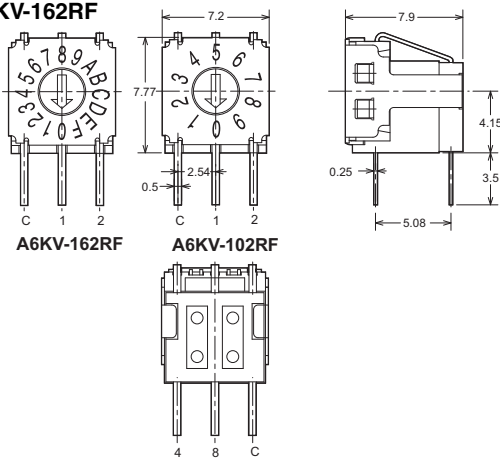

● Side-actuated Extended-shaft Models with 3×3 Terminal Arrangement A6KV-102RS A6KV-162RS

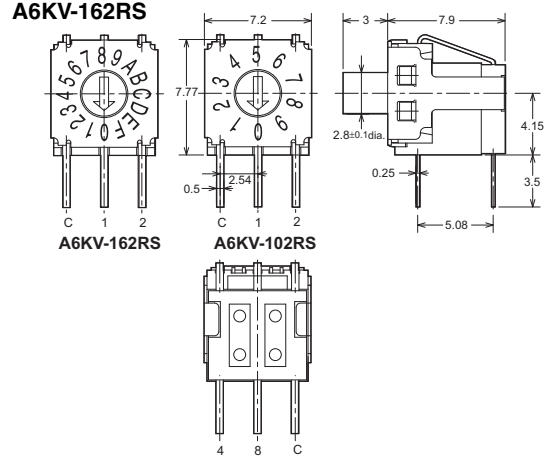

● Top-actuated Flat Models with 5×2 Terminal Arrangement A6K-104RF A6K-164RF

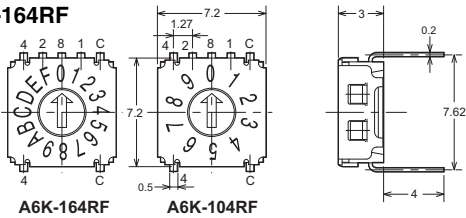

● Top-actuated Extended shaft Models with 5×2 Terminal Arrangement A6K-104RS A6K-164RS

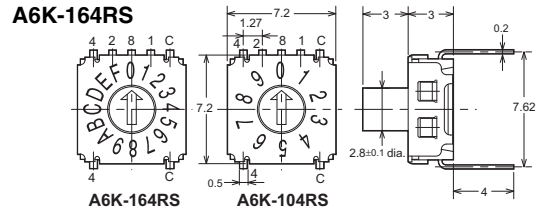

● Side-actuated Flat Models with 5×2 Terminal Arrangement A6KV-104RF A6KV-164RF

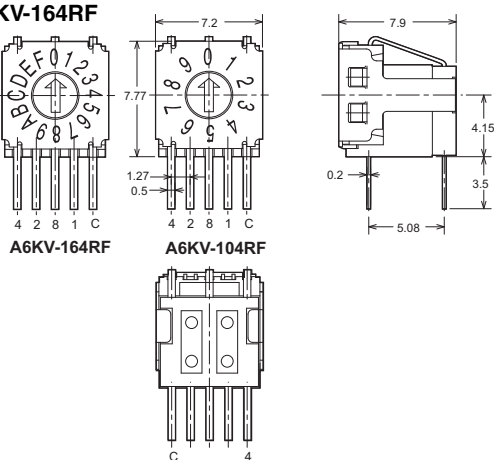

● Side-actuated Extended-shaft Models with 5×2 Terminal Arrangement A6KV-104RS A6KV-164RS

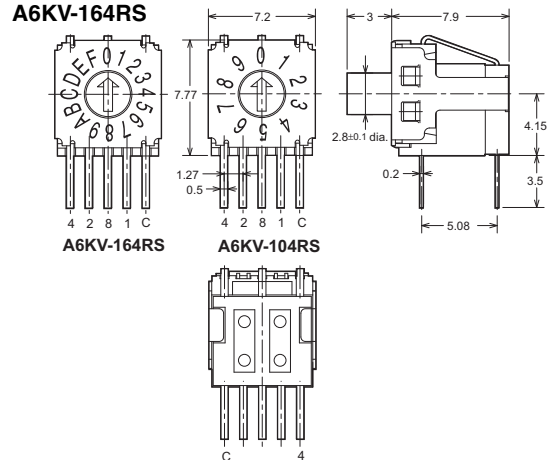

■ SMT type

● Top-actuated Flat Models with 3×3 Terminal Arrangement

A6KS-102RF

A6KS-162RF

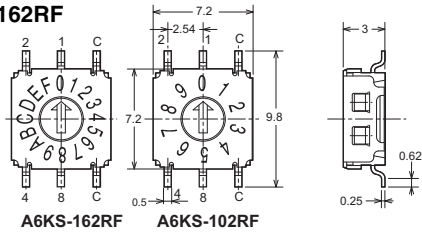

● Top-actuated Extended shaft Models with 3×3 Terminal Arrangement

A6KS-102RS

A6KS-162RS

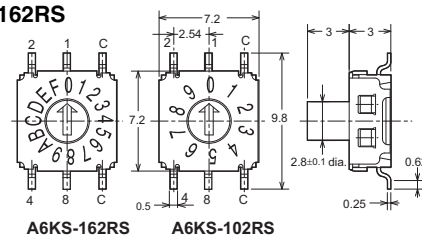

● Top-actuated Flat Models with 5×2 Terminal Arrangement

A6KS-104RF

A6KS-164RF

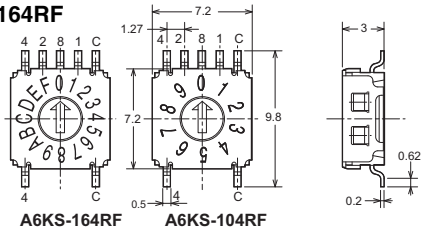

● Top-actuated Extended shaft Models with 5×2 Terminal Arrangement

A6KS-104RS

A6KS-164RS

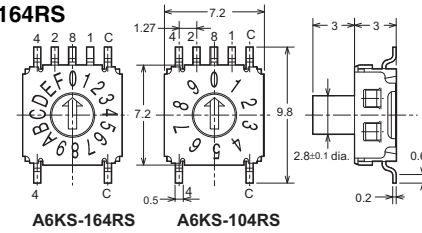

● Side-actuated Flat Models with 5×2 Terminal Arrangement

A6KSV-104RF

A6KSV-164RF

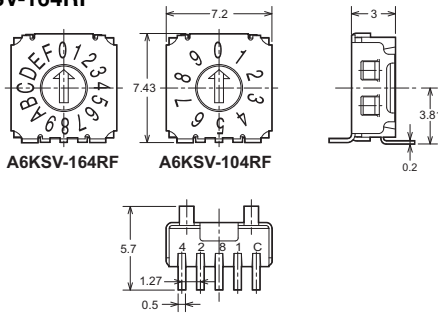

● Side-actuated Extended-shaft Models with 5×2 Terminal Arrangement

A6KSV-104RS

A6KSV-164RS

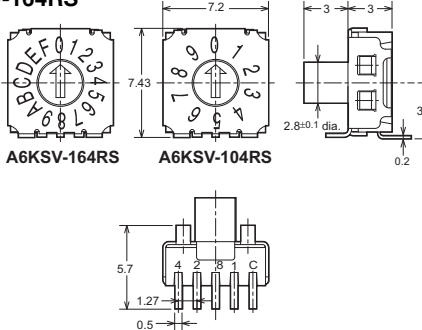

PCB Cutout Dimensions (TOP VIEW)

(Unit: mm)

● 3×3 Terminal Arrangement

Through hole (Top-actuated Models)

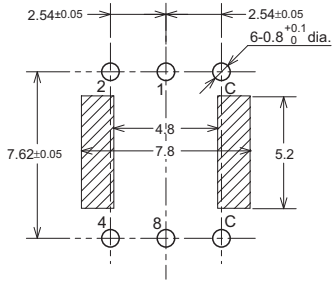

Through hole (Side-actuated Models)

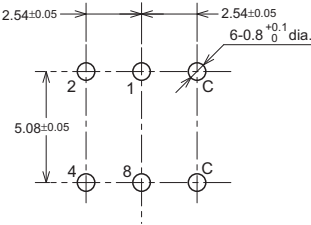

SMT (Top-actuated Models)

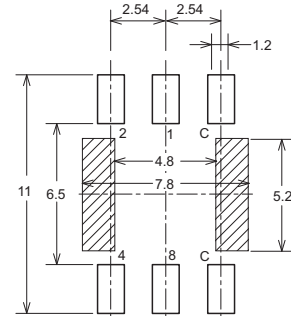

● 5×2 Terminal Arrangement

Through hole (Top-actuated Models)

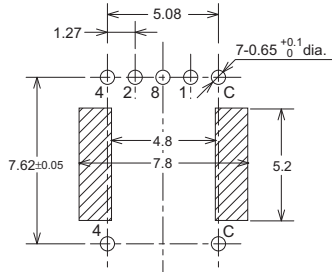

Through hole (Side-actuated Models)

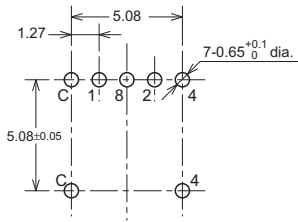

SMT (Top-actuated Models)

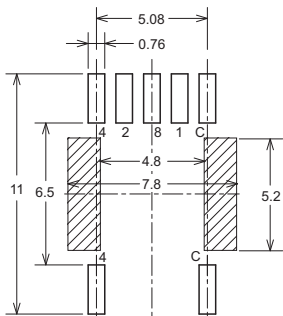

SMT (Side-actuated Models)

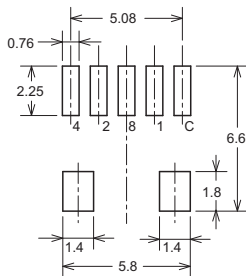

 : Through hole:Pattern prohibited area

Safety Precautions

Note: Refer to Safety Precautions in the DIP Switches (Cat. No. X040) for details on general safety precautions.

Correct Use

Soldering

General Precautions for Soldering.

Make sure that Rotary DIP Switches are set to 0 before soldering. Misalignment may result in reduced sensitivity due to the soldering heat.

Reflow Soldering

Observe the following conditions for reflow soldering. (Measurement location: Top of Switch)

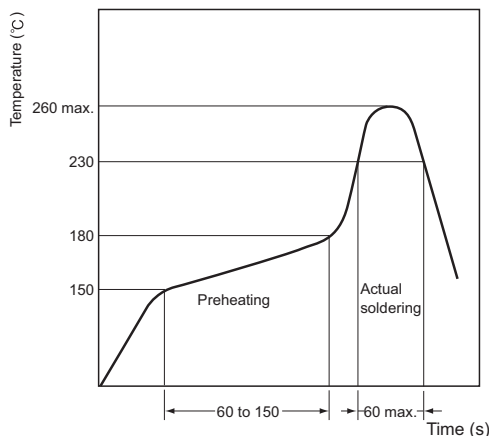

Automatic Soldering Bath

Soldering temperature: 260 °C max.
(Preheating: 150 °C · 120s max.)
Soldering time: 5s max.

Manual Soldering

Soldering temperature: 350 °C max. at the tip of the soldering iron
Soldering time: 3s max.
Do not solder the Switch more than twice including any rectification soldering. An interval of five minutes is required between the first and second soldering.

Washing

The A6K/A6KS cannot be washed. Attempting to wash it may result in malfunction due to flux and foreign matter from the PCB flowing into the A6K/A6KS together with the cleaning fluid.

Using Flux

The type of flux or the amount or method in which it is applied, including its use in reflow soldering, can have adverse effects on Switch performance. Assess the proper flux, conditions, and methods prior to using it.

RoHS Compliant

The "RoHS Compliant" designation indicates that the listed models do not contain the six hazardous substances covered by the RoHS Directive.

Reference: The following standards are used to determine compliance for the six substances.

| | |
|---------------------|------------------|
| Lead | : 1,000 ppm max. |
| Mercury | : 1,000 ppm max. |
| Cadmium | : 100 ppm max. |
| Hexavalent chromium | : 1,000 ppm max. |
| PBB | : 1,000 ppm max. |
| PBDE | : 1,000 ppm max. |

Environment for Storage and Use

To prevent discoloration of the terminals and other problems during storage, do not store the A6K/A6KS in locations subject to the following conditions.

- (1) High temperatures or humidity
- (2) Corrosive gases
- (3) Direct sunlight

Also, the A6K/A6KS is not waterproof or splash-resistant. Do not install or use the A6K/A6KS in locations that are subject to contact with water.

Do not subject the A6K/A6KS to freezing or condensation.

Handling

Do not apply excessive operating force to the Switch. Otherwise the Switch may be damaged or deformed, and the switch mechanism may malfunction as a result.

Set rotary-type DIP Switches with a flat-blade screwdriver that fits into the screwdriver groove. Using a screwdriver of inappropriate dimensions, or using a tool other than a flat-blade screwdriver may cause damage to the groove that may make the Switch impossible to operate. Extended-shaft models can also be manually set, but be sure not to apply an excessive amount of force to the Switch when setting it.

Packing Specifications

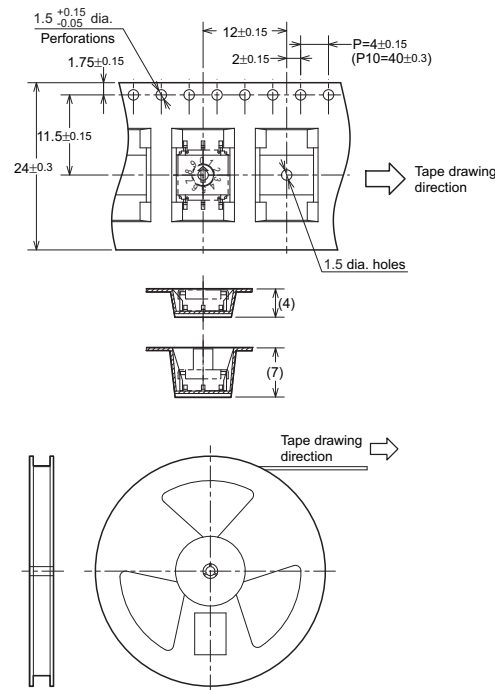

ALL DIMENSIONS SHOWN ARE IN MILLIMETERS.
To convert millimeters into inches, multiply by 0.03937. To convert grams into ounces, multiply by 0.03527.

Cat. No. A174-E1-01 In the interest of product improvement, specifications are subject to change without notice.

OMRON Corporation

Electronic Components Company

Switch Division

Manual Switch Department

Shiokoji Horikawa, Shimogyo-ku,

Kyoto, 600-8530 Japan

Tel: (81)75-344-7096/Fax: (81)75-344-7188

URL : <http://www.omron.com/ecb/>

Printed in Japan
1008-1M (1008)